

44420267	DATA SHEET	
Valid from: 14.01.2019	EPIC® POWERLOCK D6 S	

Description

- Single-pin circular connector for mobile power distribution, electro motors and generators
- Resistant to mechanical influences in harsh environmental conditions
- Connectors in harmonised colours according to European standards
- Every colour has a different coding to prevent incorrect plugging



General Characteristics

Series	D6 S
Version	cable connector, source for screw contact
Rated voltage (V)	1000 V
Rated impulse voltage	8 kV
Rated current (A)	max. crimp 400 A
Contacts	Screw termination: silver-plated brass
Number of contacts	1
Termination methods	Screw termination: 50 - 120 mm ²
Protection	IP 67 (maximum, dependant on cable gland used) IP 20 (unmated)
Cycle of mechanical operation	500
Temperature range	-25°C to +125°C
Degree of soiling	3

Product Variations

Article- Number	Article	M	Pin configuration
Type POWERLOCK D6, cable connector, source for screw contact			
44420267	POWERLOCK D6 PE/GN	40	PE, Green
44420268	POWERLOCK D6 N/BL	40	N, Blue
44420269	POWERLOCK D6 L1/BN	40	L1, Brown
44420270	POWERLOCK D6 L2/BK	40	L2, Black
44420271	POWERLOCK D6 L3/GY	40	L3, Grey
L1/red for direct current applications in conjunction with L2/black			
44420305	POWERLOCK D6 L1/RD	40	L1, Red

Materials and Surfaces

Housing	PBT
Contact retention pin	PA

Approvals

VDE-Approval, VDE-REG.-No.	D042
----------------------------	------

Creator: STKU3/PDP Released: IVSE1/PDP	Document: DB44420267EN Version: 03	Page 1 of 4
---	---------------------------------------	-------------

44420267	DATA SHEET	
Valid from: 14.01.2019	EPIC® POWERLOCK D6 S	

Technical Drawings

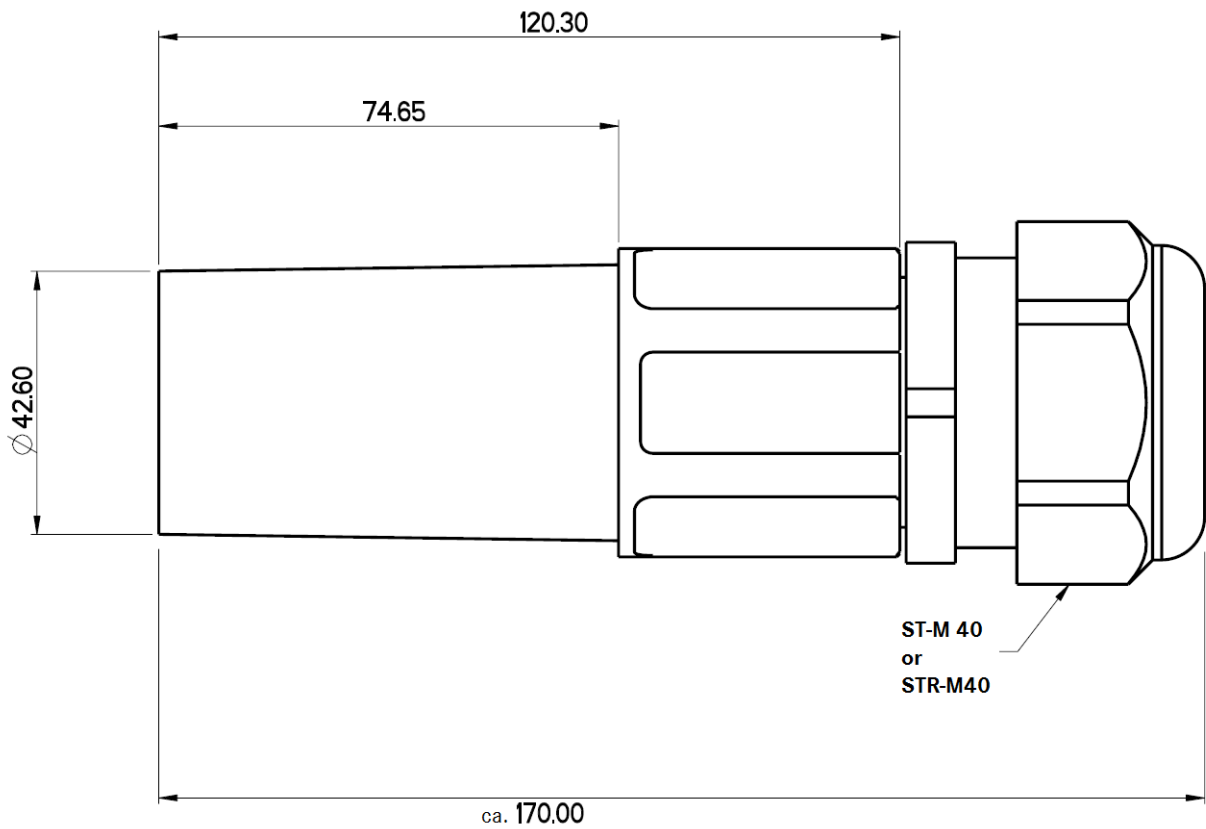





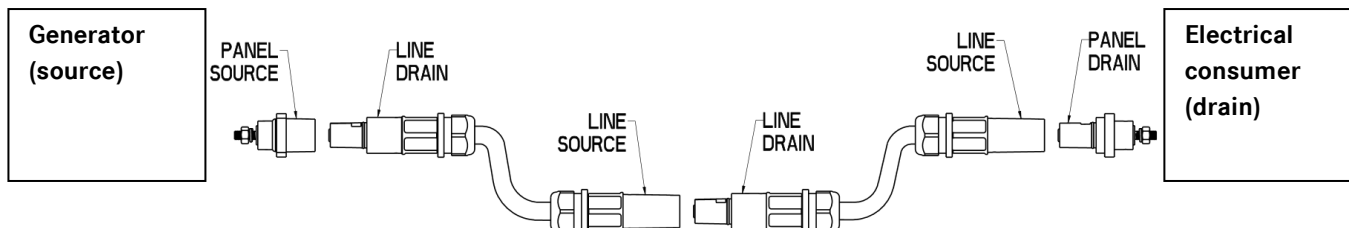

Creator: STKU3/PDP Released: IVSE1/PDP	Document: DB44420267EN Version: 03	Page 2 of 4
---	---------------------------------------	-------------

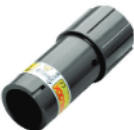
We reserve all rights according to DIN ISO 16016.
 PD 0019/05_04.18EN

System description



	Line connector	Panel mount connector	Crimp contact	Screw contact
Source	D6 	A6 		
Drain	F6 	A1 		

Step 1) Selection of housings:

Step 2) Selection of SKINTOP® cable gland M40 for the housing (only cable connectors):

e.g. 3111250 (black), 53111450 (light grey), 53111050 (silver grey)

Step 3) Decision: 400 A / max. 120mm² → Screw contacts

660 A / max. 240mm² → Crimp contacts

! Screw and crimp contacts are not allowed to be mixed!

Step 4) Selection of contacts:

Screw contacts with reduction sleeve (with 120mm² not necessary)

	50 mm ²	70 mm ²	95 mm ²	120 mm ²
Source	44420237 & 44420247	44420237 & 44420246	44420237 & 44420245	44420237
Drain	44420232 & 44420247	44420232 & 44420246	44420232 & 44420245	44420232

Contacts with M12 thread (for cable lug Ø12 mm)

	M12-thread 660 A	M12-thread 400 A
Source	 44420261	 44420242
Drain	 44420260	 44420241

Tightening torque M12 nut: 27,5 Nm - 31,4 Nm

44420267	DATA SHEET	
Valid from: 14.01.2019	EPIC® POWERLOCK D6 S	



Approved



Robust



Reliability



Waterproof

Application range

For renewable energy plants e.g. wind power
 For mobile and stationary power distribution
 For the connection of motors, transformers and generators
 Light & sound technology

Product features

Straight connector with M40 thread
 Order SKINTOP® ST-M 40 or STR-M 40 separately
 Contact fixing by contact retention pin, each pin can only be used once
 Housing without contact, order contact separately

Remark

Photographs are not to scale and do not represent detailed images of the respective products.

Creator: STKU3/PDP Released: IVSE1/PDP	Document: DB44420267EN Version: 03	Page 4 of 4
---	---------------------------------------	-------------