

INSTALLATION INSTRUCTION

## Enclosed safety switches OT63...1000

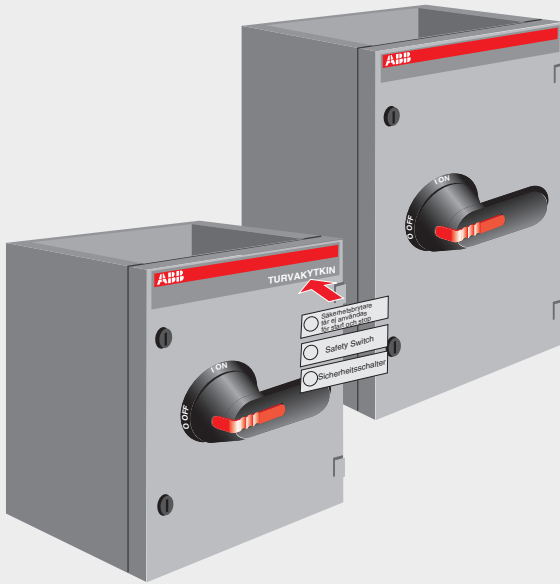

# OT63...1000

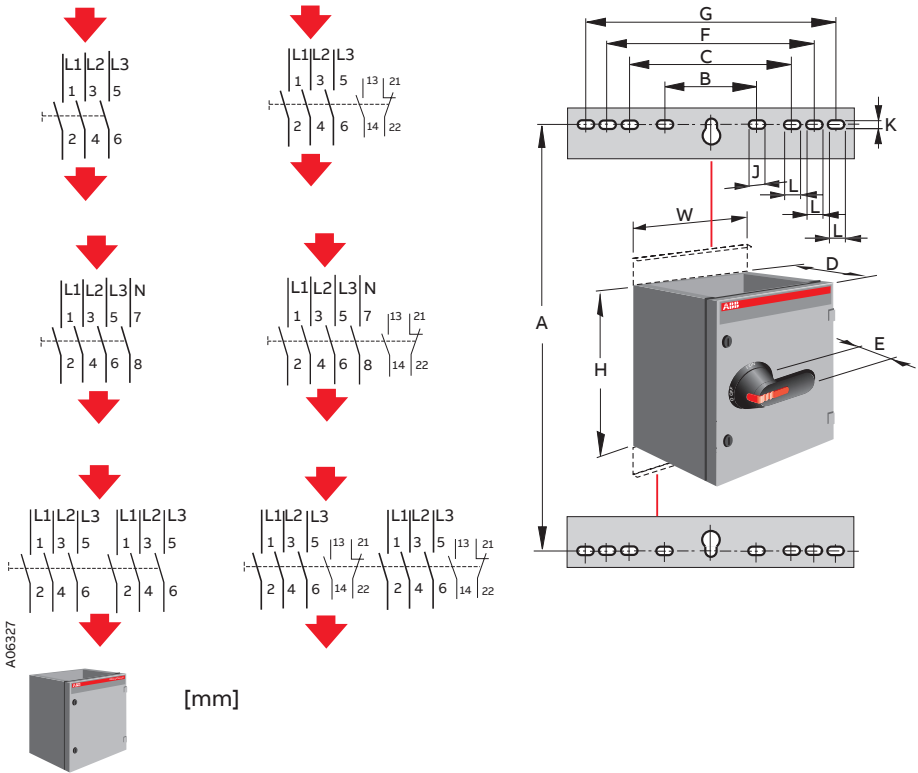

[mm]

	H	W	D	E	A	B	C	F	G	J	K	L
400 x 250 x 180	400	250	180	45	445	162	-	-	-	27	11	-
400 x 400 x 230	400	400	230	45	445	303	-	-	-	35	11	-
600 x 400 x 230	600	400	230	45	645	303	-	-	-	35	11	-
800 x 400 x 230	800	400	230	45	845	303	-	-	-	35	11	-
600 x 800 x 230	600	800	230	45	645	303	512	612	712	35	11	27
800 x 800 x 230	800	800	230	45	845	303	512	612	712	35	11	27
1000 x 400 x 230	1000	400	230	45	1045	303	-	-	-	35	11	-
1000 x 800 x 230	1000	800	230	45	1045	303	512	612	712	35	11	27
1000 x 400 x 330	1000	400	330	45	1045	303	-	-	-	35	11	-
1000 x 800 x 330	1000	800	330	45	1045	303	512	612	712	35	11	27
1200 x 800 x 230	1200	800	230	45	1245	303	512	612	712	35	11	27
1200 x 800 x 330	1200	800	330	45	1245	303	512	612	712	35	11	27

# OT63...1000

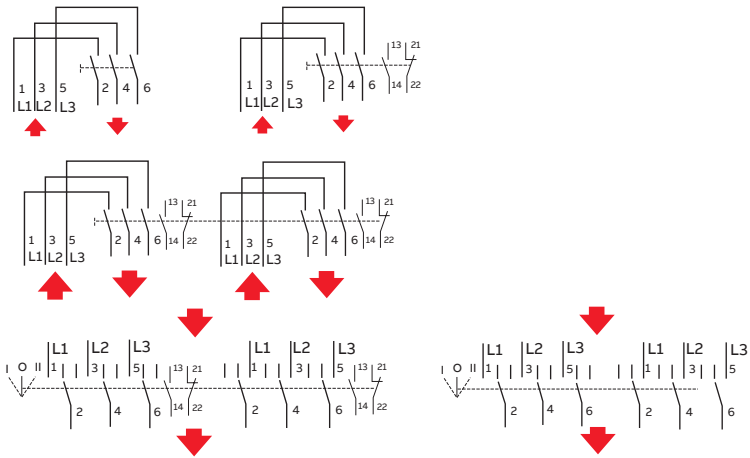





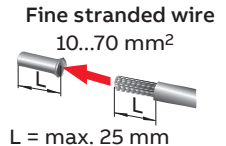
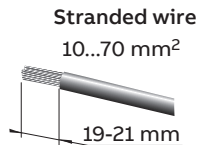
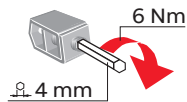





A06328A

# OT90G\_ OT125G\_

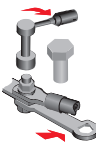

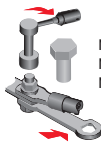
A09133

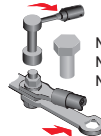
# OT63...1000

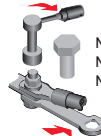
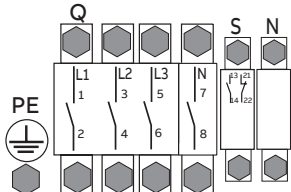
[Nm] 			
PE	Q	S	N
 M8 6 Nm  30 Nm  M6 2,5 Nm  M8 6 Nm   M8 15...22 Nm M10 30...44 Nm M12 50...75 Nm	 M8 6 Nm   M8 15...22 Nm M10 30...44 Nm M12 50...75 Nm	 0,8 Nm   M8 15...22 Nm M10 30...44 Nm M12 50...75 Nm	 2,2 Nm  M8 6 Nm   M8 15...22 Nm M10 30...44 Nm M12 50...75 Nm
			

# OT63...1000

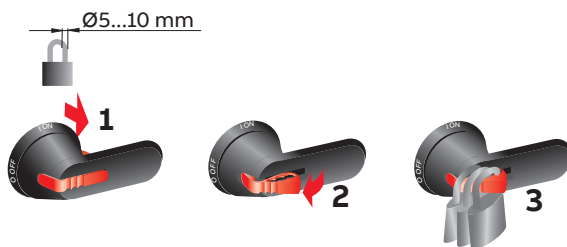
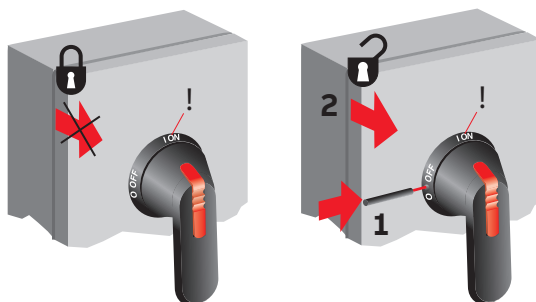

A06332



<b>BG</b>	Внимание! Опасно напряжение! Да се монтира само от лице с електротехническа квалификация.
<b>CN</b>	警告！电压危险！只能由专业电工进行安装。
<b>CZ</b>	Varování! Nebezpečné napětí! Montáž smí provádět výhradně elektrotechnik!
<b>DA</b>	Advarsel! Farlig elektrisk spænding! Installation må kun foretages af personer med elektroteknisk ekspertise.
<b>DE</b>	Warnung! Gefährliche Spannung! Installation nur durch elektrotechnische Fachkraft.
<b>EL</b>	Προειδοποίηση! Υψηλή τάση! Η εγκατάσταση πρέπει να γίνεται μόνο από εξειδικευμένους ηλεκτροτεχνικούς.
<b>EN</b>	Warning! Hazardous voltage! Installation by person with electrotechnical expertise only.
<b>ES</b>	¡Advertencia! ¡Tensión peligrosa! La instalación deberá ser realizada únicamente por electricistas especializados.
<b>ET</b>	Hoiatus! Ohtlik pinge. Paigaldada võib ainult elektrotehnika-alane ekspert.
<b>FI</b>	Varoitus! Vaarallinen jännite! Asennuksen voi tehdä vain sähköalan ammattihenkilö.
<b>FR</b>	Avertissement! Tension électrique dangereuse! Installation uniquement par des personnes qualifiées en électrotechnique.
<b>HR</b>	Upozorenje! Opasan napon! Postavljati smije samo elektrotehnički stručnjak.
<b>HU</b>	Figyelmeztetés! Veszélyes feszültség! Csak elektrotechnikai tapasztalattal rendelkező szakember helyezheti üzembe.
<b>IE</b>	Rabhadh! Voltas guaiseach! Ba chóir do dhuine ag a bhfuil saineolas leictreicniúil, agus an té sin ainmáin, é seo a shuiteáil.
<b>IT</b>	Avvertenza! Voltaggio pericoloso! Fare installare solo da un elettricista qualificato.
<b>LT</b>	Dėmesio! Pavojinga įtampa! Dirbti leidžiama tik elektrotechnikai patirties turintiems asmenims.
<b>LV</b>	Uzmanību! Bīstami - elektrība! Montāžas darbus drīkst veikt tikai personas, kurām ir atbilstošas elektrotehniskās zināšanas.
<b>MT</b>	Twissija! Voltagg perikoluż! Għandu jiġi installat biss minn persuna b'kompetenza elettroteknika.
<b>NL</b>	Waarschuwing! Gevaarlijke spanning! Mag alleen geïnstalleerd worden door een deskundige elektrotechnicus.
<b>NO</b>	Advarsel! Farlig spenning! Montering skal kun utføres av kvalifiserte personer med elektrokompetanse.
<b>PL</b>	Ostrzeżenie! Niebezpieczne napięcie! Instalacji może dokonać wyłącznie osoba z fachową wiedzą w dziedzinie elektrotechniki.
<b>PT</b>	Aviso! Tensão perigosa! A instalação só deve ser realizada por um electricista especializado.
<b>RO</b>	Avertizare! Tensiune periculoasă! Instalarea trebuie efectuată numai de către o persoană cu experiență în electrotehnică.
<b>RU</b>	Осторожно! Опасное напряжение! Монтаж должен выполняться только специалистом-электриком.
<b>SE</b>	Varning! Farlig spänning! Installation får endast utföras av en elektriker.
<b>SK</b>	Varovanie! Nebezpečné napätie! Montáž môže vykonávať iba skúsený elektrotechnik.
<b>SL</b>	Opozorilo! Nevarna napetost! Vgradnjo lahko opravi le oseba z elektrotehničnim strokovnim znanjem.



---

## Contact us

### **ABB Oy**

P.O. Box 622  
FI-65101 Vaasa  
Finland

**[abb.com/lowvoltage](https://www.abb.com/lowvoltage)**