

# A41/A42 User Manual





**A41/A42**

**User Manual**

**Document ID: 2CMC484002M0201**

**Revision: C**

**2020-12-16**

---

**Disclaimer**

The information in this document is subject to change without notice and should not be construed as a commitment by ABB Spa. ABB Spa assumes no responsibility for any errors that may appear in this document.

In no event shall ABB Spa be liable for direct, indirect, special, incidental or consequential damages of any nature or kind arising from the use of this document, nor shall ABB Spa be liable for incidental or consequential damages arising from use of any software or hardware described in this document.

---

**Copyrights**

This document and parts thereof must not be reproduced or copied without written permission from ABB Spa, and the contents thereof must not be imparted to a third party nor used for any unauthorized purpose.

The software or hardware described in this document is furnished under a license and may be used, copied, or disclosed only in accordance with the terms of such license.

© Copyright 2020 ABB Spa. All rights reserved.

---

**Trademarks**

ABB Spa is a registered trademark of the ABB Group. All other brand or product names mentioned in this document may be trademarks or registered trademarks of their respective holders.

---

**Contact**

ABB Spa  
via dell'Industria, 18  
20009 - Vittuone - Milano  
Italy  
Tel: +39 02 2415 0000

---

## Table of Content

|  |           |
|--|-----------|
| <b>1 Product Overview .....</b>                                      | <b>9</b>  |
| 1.1 Meter Parts .....  | 10        |
| 1.2 Meter Types .....  | 12        |
| <b>2 Installation .....</b>  | <b>15</b> |
| 2.1 Mounting the Meter .....   | 16        |
| 2.2 Environmental Considerations .....                               | 18        |
| 2.3 Installing the Meter .....                                       | 19        |
| 2.3.1 Configuring the meter .....                                    | 20        |
| 2.4 Wiring Diagrams .....  | 21        |
| 2.4.1 Direct connected meters .....                                  | 21        |
| 2.4.2 Transformer connected meters without voltage transformer ..... | 21        |
| 2.4.3 Transformer connected meters with voltage transformer .....    | 22        |
| 2.4.4 Inputs/outputs .....   | 22        |
| 2.4.5 Communication .....  | 23        |
| <b>3 User Interface .....</b>  | <b>25</b> |
| 3.1 Display .....  | 26        |
| <b>4 Meter Settings .....</b>  | <b>31</b> |
| 4.1 Settings and Configurations .....                                | 32        |
| 4.1.1 Setting Date .....   | 32        |
| 4.1.2 Setting Time .....   | 33        |
| 4.1.3 Setting Ratios .....   | 33        |
| 4.1.4 Setting Pulse Output .....                                     | 33        |
| 4.1.5 Setting I/O .....  | 34        |
| 4.1.6 Setting Alarm .....  | 35        |
| 4.1.7 Setting Currency/CO2 .....                                     | 36        |
| 4.1.8 Setting M-Bus .....  | 36        |
| 4.1.9 Setting RS-485 .....   | 37        |
| 4.1.10 Setting IR Side .....   | 37        |
| 4.1.11 Setting Upgrade Consent .....                                 | 39        |
| 4.1.12 Setting Pulse LED .....                                       | 39        |
| 4.1.13 Setting Tariff .....  | 39        |
| 4.1.14 Setting Previous Values .....                                 | 40        |
| 4.1.15 Setting Load Profile .....                                    | 40        |
| 4.1.16 Setting Demand .....  | 41        |
| 4.1.17 Resetting Resettable Registers .....                          | 41        |
| <b>5 Technical Description .....</b>                                 | <b>43</b> |
| 5.1 Energy Values .....  | 44        |
| 5.2 Instrumentation .....  | 46        |
| 5.3 Harmonics .....  | 47        |
| 5.3.1 Measuring Harmonics .....                                      | 49        |
| 5.4 Alarm .....  | 51        |
| 5.5 Inputs and Outputs .....   | 52        |
| 5.5.1 Tariff Inputs .....  | 52        |
| 5.5.2 Pulse Outputs .....  | 53        |
| 5.5.2.1 Pulse Frequency and Pulse length .....                       | 53        |
| 5.6 Internal Clock .....   | 55        |
| 5.7 Logs .....   | 56        |
| 5.7.1 System Log .....   | 56        |
| 5.7.2 Event Log .....  | 57        |
| 5.7.3 Net Quality Log .....  | 57        |
| 5.7.4 Audit Log .....  | 58        |

## Table of Content

---

|  |            |
|--|------------|
| 5.7.5 Settings Log .....   | 58         |
| 5.7.6 Event codes .....  | 58         |
| 5.8 Demand .....   | 60         |
| 5.9 Previous Values .....  | 62         |
| 5.10 Load Profile .....  | 64         |
| <b>6 Technical data .....</b>  | <b>67</b>  |
| 6.1 Technical Specifications .....                                       | 68         |
| 6.2 Physical dimensions .....  | 72         |
| <b>7 Measurement Methods .....</b>                                       | <b>73</b>  |
| 7.1 Measuring Energy .....   | 74         |
| 7.1.1 Single Phase, 1-Element Metering .....                             | 76         |
| <b>8 Service &amp; Maintenance .....</b>                                 | <b>79</b>  |
| 8.1 Service and Maintenance .....  | 80         |
| <b>9 Communication with Modbus .....</b>                                 | <b>81</b>  |
| 9.1 Bus Description .....  | 82         |
| 9.2 About the Modbus Protocol .....                                      | 83         |
| 9.2.1 Function Code 3 (Read holding registers) .....                     | 83         |
| 9.2.2 Function Code 16 (Write multiple registers) .....                  | 85         |
| 9.2.3 Function Code 6 (Write single register) .....                      | 86         |
| 9.2.3.1 Exception Responses .....  | 87         |
| 9.3 Reading and Writing to Registers .....                               | 88         |
| 9.4 Mapping Tables .....   | 89         |
| 9.5 Historical Data .....  | 100        |
| 9.5.1 Quantity identifiers .....   | 103        |
| 9.6 Previous Values .....  | 108        |
| 9.6.1 Reading Previous Values .....                                      | 110        |
| 9.7 Demand .....   | 112        |
| 9.7.1 Reading Demand .....   | 114        |
| 9.8 Event logs .....   | 116        |
| 9.8.1 Reading Event logs .....   | 118        |
| 9.9 Load profile .....   | 119        |
| 9.9.1 Reading Load profile .....   | 121        |
| 9.10 Configuration .....   | 122        |
| 9.10.1 Previous values .....   | 122        |
| 9.10.2 Demand .....  | 123        |
| 9.10.3 Load profile .....  | 126        |
| 9.10.4 Alarms .....  | 127        |
| 9.10.5 Inputs and outputs .....  | 131        |
| 9.10.6 Tariffs .....   | 133        |
| 9.10.7 Daylight Savings Time .....                                       | 140        |
| <b>10 Communication with M-Bus .....</b>                                 | <b>143</b> |
| 10.1 Bus Description .....   | 145        |
| 10.2 Protocol Description .....  | 146        |
| 10.2.1 Telegram Format .....   | 151        |
| 10.2.1.1 Field description .....   | 151        |
| 10.2.2 Value Information Field codes .....                               | 157        |
| 10.2.2.1 Standard VIF codes .....  | 157        |
| 10.2.2.2 Standard codes for VIFE used with extension indicator FDh ..... | 157        |
| 10.2.2.3 Standard codes for VIFE .....                                   | 158        |
| 10.2.2.4 First manufacturer specific VIFE-codes .....                    | 158        |

|          |   |     |
|----------|---|-----|
| 10.2.2.5 | VIFE-Codes for reports of record errors (meter to master)               | 160 |
| 10.2.2.6 | VIFE-Codes for object actions (master to meter)                         | 160 |
| 10.2.2.7 | 2:nd manufacturer specific VIFE followed after VIFE 1111 1000 (F8 hex): | 160 |
| 10.2.2.8 | 2:nd manufacturer specific VIFE followed after VIFE 1111 1001 (F9 hex): | 160 |
| 10.2.2.9 | 2:nd manufacturer specific VIFE followed after VIFE 1111 1110 (FE hex): | 161 |
| 10.2.3   | Communication process   | 161 |
| 10.2.3.1 | Selection and secondary addressing                                      | 163 |
| 10.3     | Standard Readout of Meter Data  | 164 |
| 10.3.1   | Example of the 1st telegram (all values are hexadecimal)                | 164 |
| 10.3.2   | Example of 2nd telegram (all values are hexadecimal)                    | 168 |
| 10.3.3   | Example of 3rd telegram (all values are hexadecimal)                    | 172 |
| 10.3.4   | Example of the 4th telegram (all values are hexadecimal)                | 177 |
| 10.3.5   | Example of the 5th telegram (all values are hexadecimal)                | 181 |
| 10.3.6   | Example of the 6th telegram (all values are hexadecimal)                | 183 |
| 10.3.7   | Example of the 7th telegram (all values are hexadecimal)                | 187 |
| 10.3.8   | Example of the 8th telegram (all values are hexadecimal)                | 190 |
| 10.3.9   | Example of the 9th telegram (all values are hexadecimal)                | 193 |
| 10.4     | Special Readout of Meter Data   | 196 |
| 10.4.1   | Readout of Load Profile Data  | 197 |
| 10.4.1.1 | Examples of Readouts of Load Profile Data                               | 202 |
| 10.4.2   | Readout of Demand Data  | 205 |
| 10.4.2.1 | Examples of Readouts of Demand Data                                     | 206 |
| 10.4.3   | Readout of Previous Values  | 211 |
| 10.4.3.1 | Examples of Readouts of Previous Values                                 | 213 |
| 10.4.4   | Readout of Event Log Data   | 216 |
| 10.4.4.1 | Example of readout of log data  | 218 |
| 10.4.5   | Readout of Current Harmonics  | 221 |
| 10.4.5.1 | Examples of Readouts of Current Harmonics Data                          | 222 |
| 10.4.6   | Readout of Voltage Harmonics  | 230 |
| 10.4.6.1 | Examples of readout of voltage harmonics data                           | 231 |
| 10.5     | Sending Data to the Meter   | 239 |
| 10.5.1   | Set tariff  | 239 |
| 10.5.2   | Set primary address   | 240 |
| 10.5.3   | Change baud rate  | 240 |
| 10.5.4   | Reset power fail counter  | 241 |
| 10.5.5   | Set Current transformer (CT) ratio - primary current                    | 241 |
| 10.5.6   | Set voltage transformer (VT) ratio - primary voltage                    | 242 |
| 10.5.7   | Set current transformer (CT) ratio - secondary current                  | 242 |
| 10.5.8   | Set voltage transformer (VT) ratio - secondary voltage                  | 243 |
| 10.5.9   | Select status information   | 243 |
| 10.5.10  | Reset of stored state for input 1                                       | 244 |
| 10.5.11  | Reset of stored state for input 2                                       | 244 |
| 10.5.12  | Reset of stored state for input 3                                       | 245 |
| 10.5.13  | Reset of stored state for input 4                                       | 245 |
| 10.5.14  | Reset of input counter 1  | 246 |
| 10.5.15  | Reset of input counter 2  | 246 |
| 10.5.16  | Reset of input counter 3  | 247 |
| 10.5.17  | Reset of input counter 4  | 247 |
| 10.5.18  | Set output 1  | 248 |
| 10.5.19  | Set output 2  | 248 |
| 10.5.20  | Set output 3  | 249 |
| 10.5.21  | Set output 4  | 249 |
| 10.5.22  | Reset power outage time   | 250 |

## Table of Content

---

|           |  |            |
|-----------|--|------------|
| 10.5.23   | Send password .....  | 250        |
| 10.5.24   | Set password .....   | 250        |
| 10.5.25   | Set date and time .....                                    | 251        |
| 10.5.26   | Set date .....   | 252        |
| 10.5.27   | Reset demand, previous values, load profile and logs ..... | 252        |
| 10.5.28   | Reset resettable active energy import .....                | 253        |
| 10.5.29   | Reset resettable active energy export .....                | 253        |
| 10.5.30   | Reset resettable reactive energy import .....              | 254        |
| 10.5.31   | Reset resettable reactive energy export .....              | 254        |
| 10.5.32   | Freeze demand .....  | 255        |
| 10.5.33   | Set write access level .....                               | 255        |
| 10.5.34   | Set tariff source .....                                    | 256        |
| 10.5.35   | Set CO2 conversion factor .....                            | 256        |
| 10.5.36   | Set currency conversion factor .....                       | 257        |
| <b>11</b> | <b>Troubleshooting .....</b>                               | <b>259</b> |
| 11.1      | Error, warnings and information codes .....                | 260        |



# Chapter 1: Product Overview

---

## Overview

This chapter describes the parts of the meter and the different meter types.

---

---

## In this chapter

The following topics are covered in this chapter:

|                       |    |
|-----------------------|----|
| 1.1 Meter Parts ..... | 10 |
| 1.2 Meter Types ..... | 12 |

## 1.1 Meter Parts

### Illustration

The parts of the meter are shown in the illustration below:

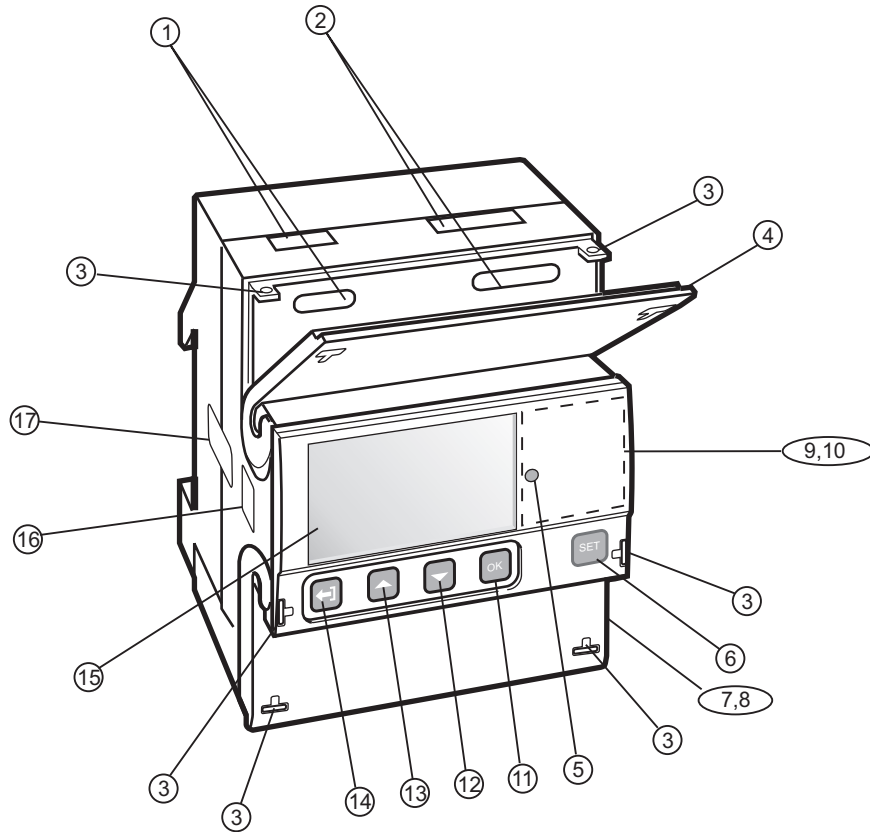

### Parts description

The following table describes the parts of the meter:

| Item | Description                           | Comments  |
|------|---------------------------------------|---|
| 1    | Terminal for communication connection |   |
| 2    | Terminal for input/output connection  |   |
| 3    | Sealing point.                        | Seal thread can be used to seal the cover.                  |
| 4    | Sealable terminal cover               | Protective cover with printed wiring diagram on the inside. |
| 5    | LED                                   | Flashes in proportion to the energy measured.               |
| 6    | Set button                            | Enter configuration mode                                    |
| 7    | Sealable terminal cover               | Protective cover with printed wiring diagram on the inside  |
| 8    | Terminal block                        | Terminal for all voltages and currents                      |
| 9    | Sealable cover                        | To protect the LCD and seal the set button                  |



| <b>Item</b> | <b>Description</b>              | <b>Comments</b>  |
|-------------|---------------------------------|--|
| 10          | Product data                    | Contains data about the meter type                                 |
| 11          | OK button                       | Perform an action or choose a menu                                 |
| 12          | Down button                     | Toggle down (toggle right in the main menu)                        |
| 13          | Up button                       | Toggle up (toggle left in the main menu)                           |
| 14          | Exit button                     | Exit to the previous menu or toggle between default and main menu. |
| 15          | Display                         | LCD for meter reading  |
| 16          | Optical communication interface | For IR communication   |
| 17          | Sealing                         |  |

---

### 1.2 Meter Types

---

#### Main groups

The A41/A42 meters are divided into two main groups:

- Direct connected meters for currents  $\leq 80\text{A}$ .
- Transformer connected meters for currents  $> 80\text{A}$  using external current transformer with secondary current  $\leq 6\text{A}$  and optional voltage transformer.

---

#### Subgroups

The main meter groups are further divided into subgroups depending on the functionality of the respective meter:

| Subgroup | Functionality  |
|----------|--|
| Platinum | Active energy, Reactive energy, Apparent energy, Import/export of energy, Resettable energy registers, Harmonics, Configurable I/O (except the 690V meter which has fixed I/O), Advanced clock functions (load profiles), Basic clock functions (Tariff control, Previous values, Max/min demand, Event log), Class 0.5 or Class 1, Tariffs, Fixed I/O, Pulse output/alarm |
| Gold     | Active energy, Reactive energy, Apparent energy, Import/export of energy, Resettable energy registers, Basic clock functions (Tariff control, Previous values, Max/min. demand, Event log), Class 0.5 or Class 1, Tariffs, Fixed I/O, Pulse output/alarm   |
| Silver   | Active energy, Reactive energy, Apparent energy, Import/export of energy, Resettable energy registers, Class 0.5 or Class 1, Tariffs, Fixed I/O, Active energy, Pulse output/alarm   |
| Bronze   | Active energy, Reactive energy, Apparent energy, Import/export of energy, Class 1, Pulse output/alarm  |
| Steel    | Active energy import, Class 1, Pulse output/alarm  |

---

**Product label**

The meter type information that is reflected on the labels on the meter is shown in the picture below:

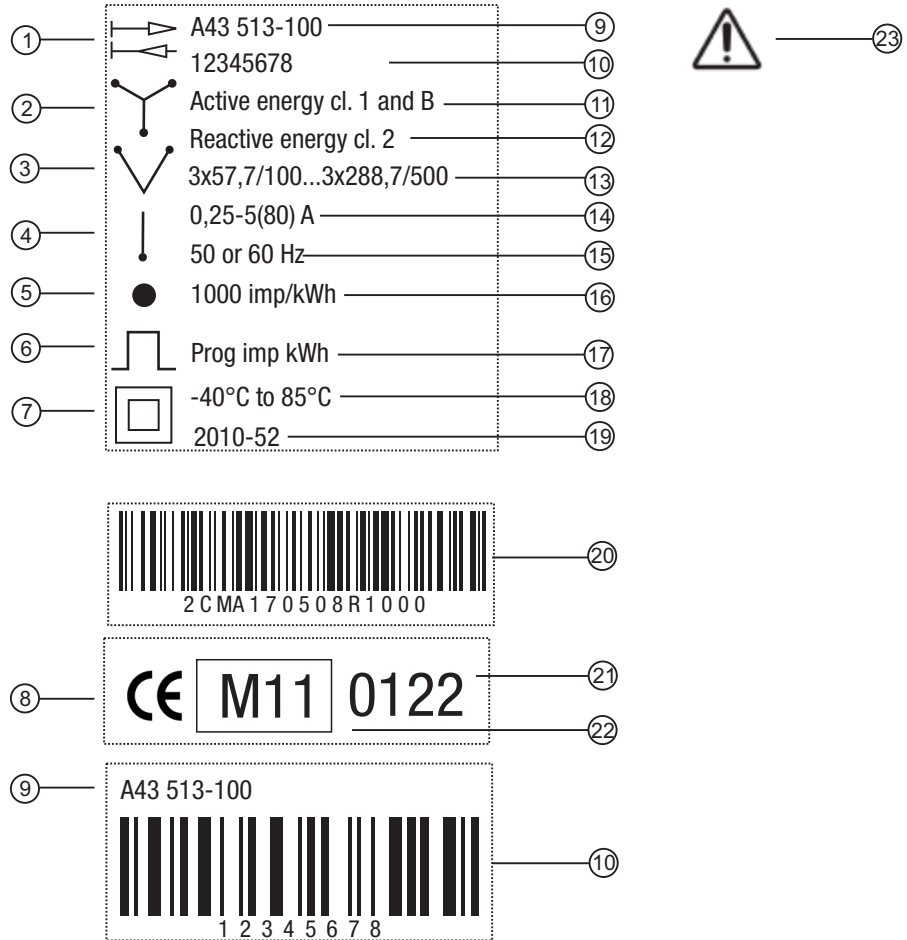

**Product label information**

The information on the product label is explained in the table below:

| Item | Description                   |
|------|-------------------------------|
| 1    | Import/export of energy       |
| 2    | 3-element metering            |
| 3    | 2-element metering            |
| 4    | 1-element metering            |
| 5    | LED                           |
| 6    | Pulse output                  |
| 7    | Protection class II           |
| 8    | Declaration of product safety |
| 9    | Type designation              |
| 10   | Serial number                 |
| 11   | Accuracy active energy        |

**Product Overview**

---

| <b>Item</b> | <b>Description</b>                      |
|-------------|---|
| 12          | Accuracy reactive energy                |
| 13          | Voltage                                 |
| 14          | Current                                 |
| 15          | Frequency                               |
| 16          | LED pulse frequency                     |
| 17          | Pulse frequency                         |
| 18          | Temperature range                       |
| 19          | Date of manufacture (year and week)     |
| 20          | ABB ID                                  |
| 21          | Notified body                           |
| 22          | MID and year of verification            |
| 23          | Caution, refer to accompanying document |

---

## Chapter 2: Installation

---

### Overview

This chapter describes how to mount the A41/A42 meters and how to connect them to an electricity network. The chapter also contains information about how to perform a basic configuration of the meter.

Information about how to connect I/O and communication options is also included in this chapter.

---

### In this chapter

The following topics are covered in this chapter:

|  |    |
|--|----|
| 2.1 Mounting the Meter .....   | 16 |
| 2.2 Environmental Considerations .....                               | 18 |
| 2.3 Installing the Meter .....                                       | 19 |
| 2.3.1 Configuring the meter .....                                    | 20 |
| 2.4 Wiring Diagrams .....  | 21 |
| 2.4.1 Direct connected meters .....                                  | 21 |
| 2.4.2 Transformer connected meters without voltage transformer ..... | 21 |
| 2.4.3 Transformer connected meters with voltage transformer .....    | 22 |
| 2.4.4 Inputs/outputs .....   | 22 |
| 2.4.5 Communication .....  | 23 |

### 2.1 Mounting the Meter

---

**General**

This section describes different ways to mount the A41/A42 meters. For some methods of mounting additional accessories are needed. For further information about accessories, refer to the Main Catalog (2CMC480001C0201).

---

**DIN-rail mounted**

The A41/A42 meters are intended to be mounted on a DIN-rail (DIN 50022). If this method of mounting is used no extra accessories are needed and the meter is fastened by snapping the DIN-rail lock onto the rail.

---

**DIN-rail**

The following picture shows a DIN-rail.

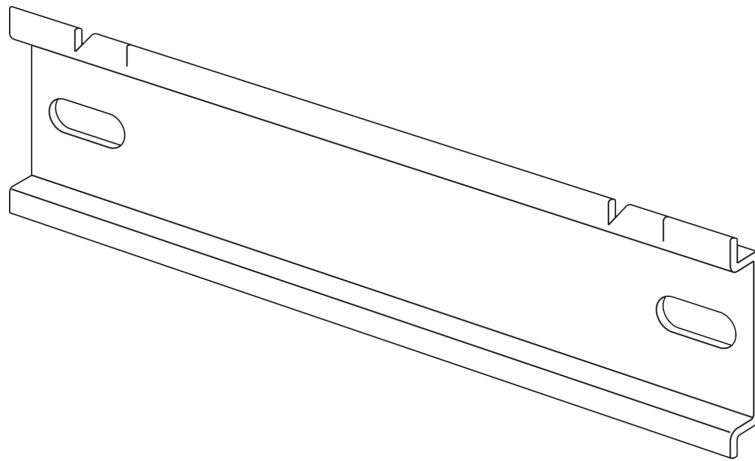

---

**Wall mounted**

The recommended way to mount the meter on a wall is to mount a separate DIN-rail on the wall and then mount the meter on the rail.



---

**Flush mounted**

To flush-mount the meter a flush-mount kit should be used.

---

**Flush-mount kit**

The following picture shows a flush-mount kit.

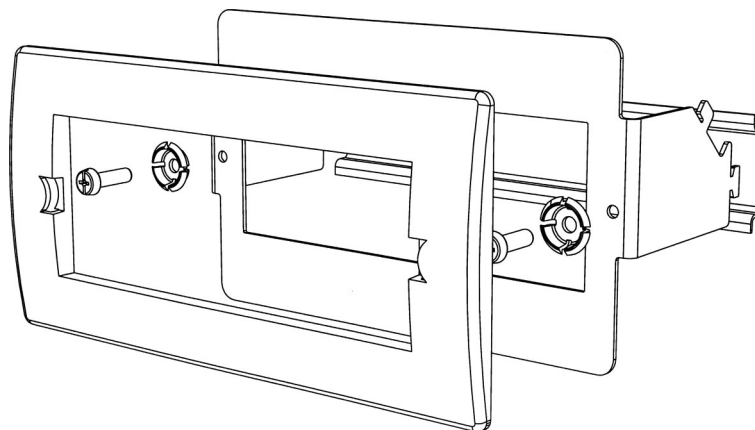

### 2.2 Environmental Considerations

---

#### Ingress protection

To comply with the protection requirements the product must be mounted in protection class IP 51 enclosures, or better, according to IEC 60259.

---

#### Mechanical environment

In accordance with the Measuring Directive (2014/32/UE), the product complies with M2, which means that it can be operated in "...locations with significant or high levels of vibration and shock, e.g. transmitted from machines and passing vehicles in the vicinity or adjacent to heavy machines, conveyor belts, etc."

---

#### Electromagnetic environment

In accordance with the Measuring Directive (2014/32/UE), the product complies with E2, which means that it can be operated "...in locations with electromagnetic disturbances corresponding to those likely to be found in other industrial buildings."

---

#### Climatic environment

In order to work properly the product should not be operated outside the specified temperature range of  $-40^{\circ}\text{C}$  -  $+70^{\circ}\text{C}$ .

In order to work properly the product should not be exposed to humidity exceeding the specified 75% yearly average, 95% on 30 days/year.

---

## 2.3 Installing the Meter



**Warning** – Electrical equipment should only be installed, accessed, serviced and maintained by qualified electrical personnel.

Working with high voltage is potentially lethal. Persons subjected to high voltage may suffer cardiac arrest, burn injuries, or other severe injuries. To avoid such injuries, make sure to disconnect the power supply before you start the installation.



**Warning** – For safety reasons it is recommended that the equipment is installed in a way that makes it impossible to reach or touch the terminal blocks by accident.

The best way to make a safe installation is to install the unit in an enclosure. Further, access to the equipment should be limited through use of lock and key, controlled by qualified electrical personnel.



**Warning** – The meters must always be protected by fuses on the incoming side.

In order to allow for maintenance of transformer rated meters, it is recommended that there should be a short circuiting device installed near the meter. Alternatively a CT with short circuiting terminals is used to short circuit the secondary current during maintenance. The reason for short circuiting the secondary current during maintenance is that a very high voltage will be induced across the terminals if current is flowing through the CT primary and any secondary terminal is disconnected. This high voltage can be potentially lethal and can damage the CT or other equipment.

**Utilization category IEC 62052-31**

A41: Utilization Category UC2

A42: Utilization Category UC1



**Installation requirements**

Meters with wireless communication should not be installed closer than 20 cm from people.

**Install the meter**

Follow the steps in the table below to install and verify the installation of the meter:

| Step                           | Action   |
|--------------------------------|--|
| 1                              | Switch off the mains power.  |
| 2                              | Place the meter on the DIN rail and make sure it snaps onto it.  |
| 3                              | Strip the cable insulation to the length that is indicated on the meter.   |
| 4                              | Connect the cables according to the wiring diagram that is printed on the meter and tighten the screws (3.0 Nm for direct connected meters and 1.5 Nm for transformer connected meters).           |
| 5                              | Install the circuit protection. See <i>table 2:1</i> below for the correct fuse.   |
| 6                              | If inputs/outputs are used, connect the cables according to the wiring diagram that is printed on the meter and tighten the screws (0.25 Nm). Then connect to an external power supply (max 240V). |
| 7                              | If communication is used, connect the cables according to the wiring diagram that is printed on the meter and tighten the screws (0.25 Nm).  |
| <b>Verify the installation</b> |  |

| Step | Action  |
|------|---|
| 8    | Check that the meter is connected to the specified voltage and that voltage phase connections and the neutral (if used) are connected to the correct terminals.   |
| 9    | For a transformer connected meter, check that the current direction of the primary and secondary current of the external transformer is correct. Also check that the transformer are connected to the correct meter terminals.  |
| 10   | Switch on the power. If a warning symbol is displayed, refer to the error codes in <i>Troubleshooting</i> .   |
| 11   | Under the menu item "Instantaneous Values" on the meter, check that the voltage, current, power and power factor are reasonable and that the power direction is what to be expected (the total power should be positive for a load that consumes energy). When doing the check the meter should be connected to the intended load, with a current above zero to make the check as complete as possible. |

---

**Circuit protection** Use the information in this table to select the correct fuse for the circuit protection.

**Tabelle: 2:1**

| Meter type            | Max circuit protection                             |
|-----------------------|--|
| Direct connected      | 80 A MCB, C characteristic or 80 A fuse type gL-gG |
| Transformer connected | 10 A MCB, B characteristic or Diazed, fast.        |

### 2.3.1 Configuring the meter

---

**Default settings** For information about how to change the default settings of the meter, refer to the chapter called *Meter Settings*.

---

**Default settings** The following table lists the default settings of the meter that normally need to be changed. Check the settings of the meter to see if they need to be reconfigured.

| Parameter       | Direct connected meters    | Transformer connected meters |
|-----------------|----------------------------|------------------------------|
| Clock           | ---                        | ---                          |
| Ratios VT       | ---                        | 1                            |
| Ratios CT       | ---                        | 1                            |
| Pulse frequency | 100 impulses / kWh (kvarh) | 10 impulses / kWh (kvarh)    |
| Pulse length    | 100 ms                     | 100 ms                       |

---

## 2.4 Wiring Diagrams

### General



This section describes how to connect the different types of meters to an electricity network. The terminal numbers in the wiring diagrams listed below correspond to the marking on the terminal block of the meter.

### 2.4.1 Direct connected meters

**2-wire connection** The following diagram shows a 2-wire connection of a direct connected 1-phase meter:

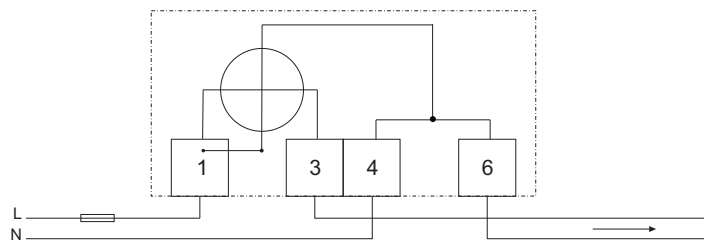

### 2.4.2 Transformer connected meters without voltage transformer

**2-wire connection** The following diagram shows a 2-wire connection of a transformer connected 3-phase meter:

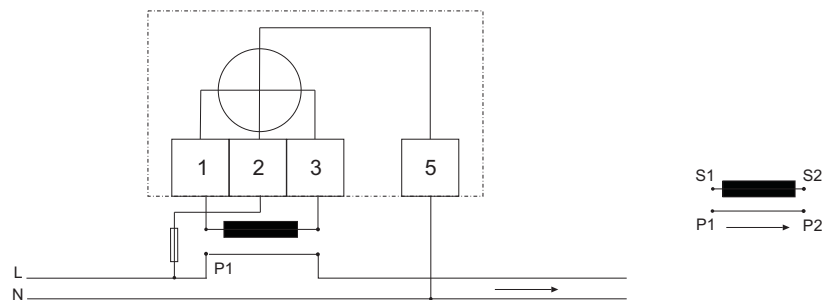

## 2.4.3 Transformer connected meters with voltage transformer

**2-wire connection** The following diagram shows a 2-wire connection of a transformer connected 3-phase meter with voltage transformers:

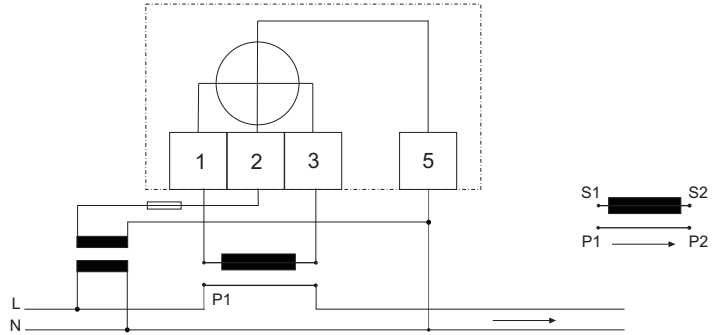

## 2.4.4 Inputs/outputs

**2 outputs, 2 inputs**

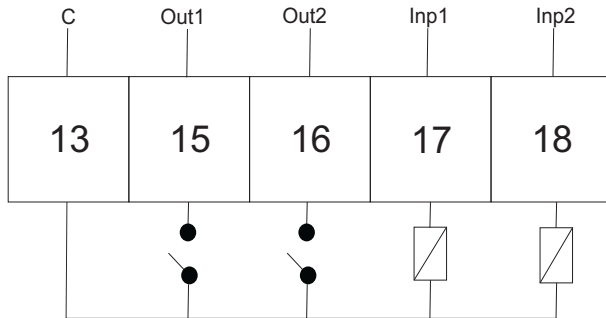

**4 configurable inputs/outputs**

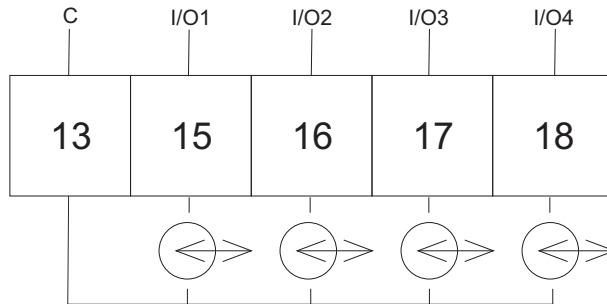

**1 output**

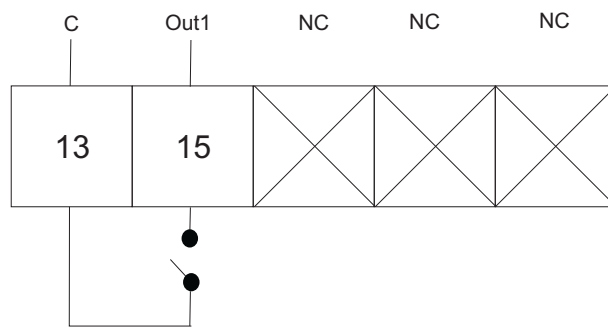

---

**2.4.5 Communication**

**RS-485**

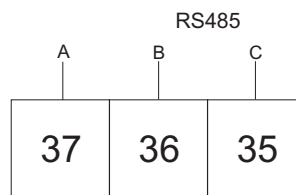

---

**M-Bus**

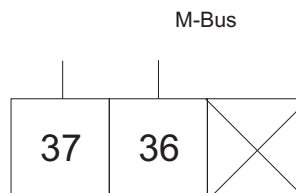





# Chapter 3: User Interface

**Overview**

---

This chapter describes the different display views and the menu structure.

---

**In this chapter**

---

The following topics are covered in this chapter:

3.1 Display ..... 26

## 3.1 Display

### General

The display contains two main views, the Default menu and the Main menu. Use the Exit button  to toggle between the views. In both views a number status icons are displayed in the upper part of the display. These icons are explained in *table 3:1* below. In the same manner the bottom part of the display has an explanatory text to describe what is shown or highlighted at the moment.

### Default menu

The following image shows an example of the layout of the Default menu:

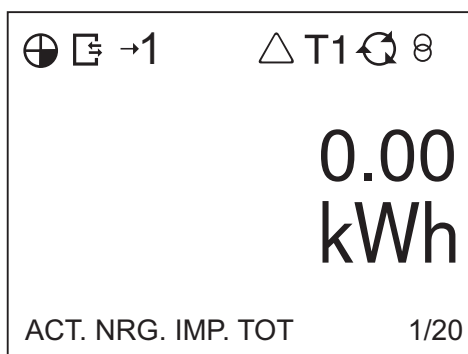

### Energy values

The following table explains the content of the 25 available pages in the Default menu:

| Page | Unit  | Text on display   | Explaining text                              |
|------|-------|-------------------|--|
| 1/25 | kWh   | ACT.NRG.IMP.TOT   | Measures the total imported active energy.   |
| 2/25 | kWh   | ACT.NRG.EXP.TOT   | Measures the total exported active energy.   |
| 3/25 | kWh   | ACT.NRG.NET.TOT   | Measures the total net active energy.        |
| 4/25 | kvarh | REACT.NRG.IMP.TOT | Measures the total imported reactive energy. |
| 5/25 | kvarh | REACT.NRG.EXP.TOT | Measures the total exported reactive energy  |
| 6/25 | kvarh | REACT.NRG.NET.TOT | Measures the total net reactive energy       |
| 7/25 | kVAh  | APP.NRG.IMP.TOT   | Measures the total imported apparent energy  |
| 8/25 | kVAh  | APP.NRG.EXP.TOT   | Measures the total exported apparent energy  |

| Page  | Unit  | Text on display    | Explaining text                                    |
|-------|-------|--------------------|--|
| 9/20  | kVAh  | APP.NRG.NET.TOT    | Measures the total net apparent energy             |
| 10/25 | kWh   | ACT.NRG.IMP.TAR1   | Measures the imported active energy for tariff 1   |
| 11/25 | kWh   | ACT.NRG.IMP.TAR2   | Measures the imported active energy for tariff 2   |
| 12/25 | kWh   | ACT.NRG.IMP.TAR3   | Measures the imported active energy for tariff 3   |
| 13/25 | kWh   | ACT.NRG.IMP.TAR4   | Measures the imported active energy for tariff 4   |
| 14/25 | kWh   | ACT.NRG.EXP.TAR1   | Measures the exported active energy for tariff 1   |
| 15/25 | kWh   | ACT.NRG.EXP.TAR2   | Measures the exported active energy for tariff 2   |
| 16/25 | kWh   | ACT.NRG.EXP.TAR3   | Measures the exported active energy for tariff 3   |
| 17/25 | kWh   | ACT.NRG.EXP.TAR4   | Measures the exported active energy for tariff 4   |
| 18/25 | kvarh | REACT.NRG.IMP.TAR1 | Measures the imported reactive energy for tariff 1 |
| 19/25 | kvarh | REACT.NRG.IMP.TAR2 | Measures the imported reactive energy for tariff 2 |
| 20/25 | kvarh | REACT.NRG.IMP.TAR3 | Measures the imported reactive energy for tariff 3 |
| 21/25 | kvarh | REACT.NRG.IMP.TAR4 | Measures the imported reactive energy for tariff 4 |
| 22/25 | kvarh | REACT.NRG.EXP.TAR1 | Measures the exported reactive energy for tariff 1 |
| 23/25 | kvarh | REACT.NRG.EXP.TAR2 | Measures the exported reactive energy for tariff 2 |
| 24/25 | kvarh | REACT.NRG.EXP.TAR3 | Measures the exported reactive energy for tariff 3 |
| 25/25 | kvarh | REACT.NRG.EXP.TAR4 | Measures the exported reactive energy for tariff 4 |

## Status Icons

The status icons that can be seen the display are explained in the following table.

**Table: 3:1**

| Icon                 | Indication  |
|----------------------|---|
| ⊕ ⊕ ⊕ ⊕              | Active quadrant   |
| ☒                    | Communication is in progress. The meter is either sending or receiving information  |
| ↻                    | Rotates when metering in progress, that is when the phase current is above the starting current   |
| 1-1 ←1 2-2 ←2 3-3 ←3 | Arrows indicate direction of current. Arrow left = export, arrow right = import. A digit without arrow indicates that the current is below the starting current |
| T1 T2 T3 T4          | Active tariff   |
| ⚠ ! ⚠                | Error, warning, note  |
| ⊗                    | Transformer ratio (only on transformer rated meters)  |

## Main menu

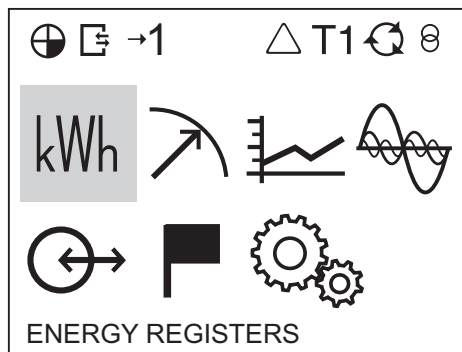

The following image shows an example of the layout of the main menu:



## Main menu icons







Depending on the meter type all or a subset of the following icons may be available in the display:

| Icon       | Explanation          |
|------------|----------------------|
| kWh        | Energy registers     |
| ↗          | Instantaneous values |
| Line graph | Stored values        |
| Waveform   | Harmonics            |
| ↔          | I/O                  |

| Icon  | Explanation |
|---|-------------|
|  | Status      |
|  | Settings    |







**Main menu structure**

The following table describes the main menu structure and its content. Depending on meter type, all or a subset of the items can be present.

|  |  |  |  |  |  |  |
|---|---|---|---|--|---|---|
| Active Energy Import  | Active Power  | Previous Values   | THD Voltage   | I/O 1  | System Log  | Clock   |
| Active Energy Export  | Reactive Power  | Load Profiles   | Harmonics Voltage   | I/O 2  | Event Log   | Ratios  |
| Active Energy Net   | Apparent Power  | Demand  | THD Current   | I/O 3  | Net Quality Log   | Wires   |
| Reactive Energy Import  | Phase Voltage   |   | Harmonics Current   | I/O 4  | System Status   | Pulse Output  |
| Reactive Energy Export  | Main Voltage  |   |   |  | Audit Log   | I/O   |
| Reactive Energy Net   | Current   |   |   |  | Settings Log  | Alarm   |
| Apparent Energy Import  | frequency   |   |   |  | About   | Currency/CO <sub>2</sub>  |
| Apparent Energy Export  | Power Factor  |   |   |  |   | RS-485  |
| Apparent Energy Net   | Phase Angle Power   |   |   |  |   | IR Side   |
| Active Energy Import Tariff   | Phase Angle Voltage   |   |   |  |   | Wireless  |
| Active Energy Export Tariff   | Phase Angle Current   |   |   |  |   | Upgrade Consent   |
| Reactive Energy Import Tariff   | Current Quadrant  |   |   |  |   | Pulse LED   |
| Reactive Energy Export Tariff   |   |   |   |  |   | Tariff  |
| Resettable Active Energy Import Total   |   |   |   |  |   | Previous Values   |
| Resettable Active Energy Export Total   |   |   |   |  |   | Load profiles   |
| Resettable Reactive Energy Import Total   |   |   |   |  |   | Demand  |
| Resettable Reactive Energy Export Total   |   |   |   |  |   | Resettable registers  |

User Interface

---

|   |   |   |   |  |   |   |
|---|---|---|---|--|---|---|
|  |  |  |  |  |  |  |
| Currency  |   |   |   |  |   |   |
| CO <sub>2</sub>   |   |   |   |  |   |   |

## Chapter 4: Meter Settings

---

### Overview

This chapter gives an overview of the meter settings and configuration options.

---

### In this chapter

The following topics are covered in this chapter:

|   |    |
|---|----|
| 4.1 Settings and Configurations .....       | 32 |
| 4.1.1 Setting Date .....                    | 32 |
| 4.1.2 Setting Time .....                    | 33 |
| 4.1.3 Setting Ratios .....                  | 33 |
| 4.1.4 Setting Pulse Output .....            | 33 |
| 4.1.5 Setting I/O .....                     | 34 |
| 4.1.6 Setting Alarm .....                   | 35 |
| 4.1.7 Setting Currency/CO2 .....            | 36 |
| 4.1.8 Setting M-Bus .....                   | 36 |
| 4.1.9 Setting RS-485 .....                  | 37 |
| 4.1.10 Setting IR Side .....                | 37 |
| 4.1.11 Setting Upgrade Consent .....        | 39 |
| 4.1.12 Setting Pulse LED .....              | 39 |
| 4.1.13 Setting Tariff .....                 | 39 |
| 4.1.14 Setting Previous Values .....        | 40 |
| 4.1.15 Setting Load Profile .....           | 40 |
| 4.1.16 Setting Demand .....                 | 41 |
| 4.1.17 Resetting Resettable Registers ..... | 41 |

### 4.1 Settings and Configurations

---

#### Configurable functions

Depending on the meter type, all or a subset of the following functions can be configured:

- Clock
- Ratios
- Wires
- Pulse output (Pul.Out.) on display
- I/O
- Alarm
- Currency/CO<sub>2</sub> (Curr/CO<sub>2</sub>) on display
- M-Bus
- RS-485
- IR Side
- Wireless (W-less on display)
- Upgrade Consent (Upgr.Cons) on display
- Pulse LED (Puls.LED) on display
- Tariff
- Previous Values (Prev. Val. on display)
- Load profile (Load Pro on display)
- Demand
- Resettable registers (Rst.Rg on display)

---

#### Setting a value

When setting a value, the **SET** button is used to activate the set-option. The **▼** and **▲** buttons are used to change the options that can be set, such as on or off. If the set-option involves setting a number, for example a alarm limit, the **▲** button is used to increase a digit, and the **▼** button is used to decrease a digit. The **OK** button is used to toggle between digits. The option/digit that is active for setting is marked with a underscore. When the underscore on the last option has disappeared, the setting has been performed.

---

#### 4.1.1 Setting Date

To set the date, perform the following steps:

1. Choose the Settings icon in the main menu, press **OK**.
2. Choose “Clock”, press **OK**.
3. The display will now show the date.
4. Set the date.



### 4.1.2 Setting Time

To set the time, perform the following steps:

1. Choose the Settings icon in the main menu, press .
2. Choose “Clock”, press .
3. The display will now show the date. Press  to get to the time-menu.
4. Set the time.

### 4.1.3 Setting Ratios

To set the ratios, perform the following steps:

1. Choose the Settings icon in the main menu, press .
2. Choose “Ratios”, press .
3. The display will show the quantity Current (CT on the display) and the ratio. To change the ratio, press . See *table 4:1* for interval.
4. Press . The display will show the quantity Voltage (VT on the display) and the ratio. To change the ratio, press . See *table 4:1* for interval.

**Table: 4:1**

| Option                   | Interval       |
|--------------------------|----------------|
| Transformer Current (CT) | 1-9999/1-9     |
| Transformer Voltage (VT) | 1-999999/1-999 |

### 4.1.4 Setting Pulse Output

To set the pulse output, perform the following steps:

1. Choose the Settings icon in the main menu, press .
2. Choose “Pulse out” (Pul.out on the display), press .

The display will show what type of energy is measured on pulse output 1. Depending on meter type, the available choices are:

|                              |                          |
|------------------------------|--------------------------|
| Act.Nrg.Imp on the display   | Active energy imported   |
| Act.Nrg.Exp on the display   | Active energy exported   |
| React.Nrg.Imp on the display | Reactive energy imported |
| React.Nrg.Exp on the display | Reactive energy exported |
| Inactive on the display      | Inactive                 |

3. Set the energy type.
4. Press  once to get to the next menu. The display will show the frequency. The interval that can be set is 0-999999 imp/kWh or 0-999999 imp/MWh. Set the frequency and quantity.
5. Press  once to get to the next menu. The display will show the pulse length in milliseconds. The interval for the pulse length is from 10 to 990ms. Set the pulse length.
6. Press  once to get to the next menu. The display will show the setting for pulse output 1. Depending on the meter type, the available choices are:

| 4 configurable I/Os | 4 static I/Os | 1 static I/O |
|---------------------|---------------|--------------|
| No output           | No output     | No output    |
| Out 1               | Out 1         | Out 1        |
| Out 2               | Out 2         | -            |
| Out 3               | -             | -            |
| Out 4               | -             | -            |



**Note** – If choosing an I/O that is not pulse output configured, the option is set to “no output” when pressing the **OK** button.

- The first pulse output is now fully configured. Depending on the meter type, up to four pulse outputs can be set. If your meter supports multiple pulse outputs, use **▼** to toggle down to the remaining pulse outputs and set them the same way as pulse output 1.

### 4.1.5 Setting I/O

To set the I/O, perform the following steps:

- Choose the Settings icon in the main menu, press **OK**.
- Choose “I/O”, press **OK**.
- The display will now show I/O 1. To change I/O, use **▲** or **▼**. To set an I/O, press the **SET** button. Depending on the meter type, different choices can be made for the I/O, see *table 4:2*.

**Table: 4:2**

| I/O                        | Available choices  |
|----------------------------|--|
| 4 configurable I/Os        | <ul style="list-style-type: none"> <li>• Input</li> <li>• Alarm out</li> <li>• Communication out (Comm.out on display)</li> <li>• Pulse out (Pul.out on display)</li> <li>• Tariff out<sup>1</sup></li> <li>• Always on</li> <li>• Always off</li> </ul> |
| 4 static I/Os <sup>2</sup> | <ul style="list-style-type: none"> <li>• Alarm out</li> <li>• Communication out (Comm.out on display)</li> <li>• Pulse out (Pul.out on display)</li> <li>• Tariff out<sup>3</sup></li> <li>• Always on</li> <li>• Always off</li> </ul>                  |
| 1 static I/O               | <ul style="list-style-type: none"> <li>• Alarm out</li> <li>• Communication out (Comm.out on display)</li> <li>• Pulse out Pul.out on display)</li> <li>• Always on</li> <li>• Always off</li> </ul>   |

- This choice makes it possible to control outputs by time.

2. I/O 1 and I/O 2 are set to static output by default. I/O 3 and 4 are set to static output by default and cannot be configured. I/O 3 and I/O 4 are not shown in the display.
3. This choice makes it possible to control fixed I/O outputs by time and thus only available in gold meters.

### 4.1.6 Setting Alarm

To set the alarm, perform the following steps:

1. Choose the Settings icon in the main menu, press .
2. Choose “Alarm”, press .
3. The display will show what quantity shall be measured. Depending on the meter type, different quantities are available. See *table 4:3* and *table* for available quantities and interval/units for the different quantities. Set the desired quantity.
4. Press  once to get to the next menu. The display will show what level the alarm will trigger on. Set the alarm level.
5. Press  once to get to the next menu. The display will show the time that the measured value has to be higher than the limit set in the previous step in order for the alarm to trigger. Set the time limit.
6. Press  once to get to the next menu. The display will show what level the alarm will cease on. Set the alarm level.
7. Press  once to get to the next menu. The display will show the time that the measured value has to be lower than the limit set in the previous step in order for the alarm to cease. Set the time limit.
8. Press  once to get to the next menu. The display will show if the alarm will be logged or not. The available values are “on” and “off”. Set logging to on or off.
9. Press  once to get to the next menu. The display will show what output the alarm is set on (or if no output is set). The available choices are dependent on meter type, see *table 4:4*.



**Note** – If choosing an I/O that is not alarm configured, the option will be set to “no output” when pressing the  button.

10. The first alarm is now fully configured. Depending on the meter type, up to four alarms can be set. If your meter supports multiple alarms, use  and  to set the remaining alarms the same way as the first alarm was configured.

**Table: 4:3**

| Alarm alternatives  | Interval/Unit   |
|---------------------|-----------------|
| Inactive            | -               |
| Current L1          | 0.01-99.99 A/kA |
| Voltage L1          | 0.1-999.9 V/kV  |
| Harmonic voltage L1 | 0 - 999 %       |
| Harmonic current L1 | 0 - 999 %       |
| Active power total  | 0-9999 W/kW/MW  |

| Alarm alternatives   | Interval/Unit        |
|----------------------|----------------------|
| Reactive power total | 0-9999 var/kvar/Mvar |
| Apparent power total | 0-9999 VA/kVA/MVA    |
| Power factor total   | 0.000-0.999          |

**Table: 4:4**

| 4 configurable I/Os | 4 static I/Os | 1 static I/O |
|---------------------|---------------|--------------|
| No output           | No output     | No output    |
| Out 1               | Out 1         | Out 1        |
| Out 2               | Out 2         |              |
| Out 3               |               |              |
| Out 4               |               |              |

### 4.1.7 Setting Currency/CO<sub>2</sub>

By setting a conversion factor for Currency/CO<sub>2</sub>, kWh is converted to currency and/or kg CO<sub>2</sub>.

To set currency/CO<sub>2</sub>, perform the following steps:

1. Choose the Settings icon in the main menu, press .
2. Choose "Currency/CO<sub>2</sub>" (Curr/CO<sub>2</sub> on the display), press .
3. The display will show price in currency per unit.
4. Press  to set the the conversion factor and the quantity.
5. Use  to get to the next page. The page will display the CO<sub>2</sub> emissions in kg per kWh.
6. Press  to set the conversion factor for CO<sub>2</sub>.

### 4.1.8 Setting M-Bus

To set the wired M-Bus interface, perform the following steps:

1. Choose the Settings icon in the main menu, press .
2. Choose "Mbus", press .
3. Press  once to get to the next menu. The display will show the baudrate. See *Table 4:5* for baudrate options. Set baudrate.
4. Press  once to get to the next menu. The display will show the address. See *Table 4:5* for address range. Set address.
5. Press  once to get to the next menu. The display will show the access level. See *Table 4:5* for options. Set the access level.
6. Press  once to get to the next menu. The display will show the Send status info. See *Table 4:5* for options. Set the send info status.
7. Press  once to get to the next menu. The display will show if the password is to be reset. See *Table 4:5* for options. Set the option.

### 4.1.9 Setting RS-485

The RS-485 uses the EQ-Bus and the Modbus protocol to communicate. To set the RS-485 communication depending on protocol, perform the following steps:

| Step | EQ-Bus  | Modbus   |
|------|---|--|
| 1    | Choose the Settings icon in the main menu, press <input type="button" value="OK"/> .  | Choose the Settings icon in the main menu, press <input type="button" value="OK"/> .   |
| 2    | Choose communication interface.   | Choose communication interface.  |
| 3    | Choose EQ-Bus.  | Choose Modbus.   |
| 4    | Press <input type="button" value="Next"/> once to get to the next menu. The display will show the baudrate. See <i>Table 4:5</i> for baudrate options. Set baudrate.            | Press <input type="button" value="Next"/> once to get to the next menu. The display will show the baudrate. See <i>Table 4:5</i> for baudrate options. Set baudrate. |
| 5    | Press <input type="button" value="Next"/> once to get to the next menu. The display will show the address. See <i>Table 4:5</i> for address range. Set address.                 | Press <input type="button" value="Next"/> once to get to the next menu. The display will show the address. See <i>Table 4:5</i> for address range. Set address.      |
| 6    | Press <input type="button" value="Next"/> once to get to the next menu. The display will show the Oct. TO. See <i>Table 4:5</i> for options. Set Oct. TO                        | Press <input type="button" value="Next"/> once to get to the next menu. The display will show the Parity. See <i>Table 4:5</i> for options. Set Parity.              |
| 7    | Press <input type="button" value="Next"/> once to get to the next menu. The display will show the Inac. TO. See <i>Table 4:5</i> for options. Set Inac. TO                      |  |
|      | Press <input type="button" value="Next"/> once to get to the next menu. The display will show if the password is to be reset. See <i>Table 4:5</i> for options. Set the option. |  |

### 4.1.10 Setting IR Side

The IR Side uses the M-Bus and the EQ-Bus<sup>i</sup> protocol to communicate. To set the IR Side communication depending on protocol, perform the following steps:

| Step | M-Bus  | EQ-Bus   |
|------|--|--|
| 1    | Choose the Settings icon in the main menu, press <input type="button" value="OK"/> .   | Choose the Settings icon in the main menu, press <input type="button" value="OK"/> .   |
| 2    | Choose IR Side, press <input type="button" value="OK"/> .  | Choose IR Side, press <input type="button" value="OK"/> .  |
| 3    | Press <input type="button" value="SET"/> and choose M-Bus.   | Press <input type="button" value="SET"/> and choose EQ-Bus.  |
| 4    | Press <input type="button" value="Next"/> once to get to the next menu. The display will show the baudrate. See <i>Table 4:5</i> for baudrate options. Set baudrate. | Press <input type="button" value="Next"/> once to get to the next menu. The display will show the baudrate. See <i>Table 4:5</i> for baudrate options. Set baudrate. |

i. EQ-Bus is a communication protocol designed for internal communication with ABB meters. The protocol is based on the following IEC standards; 62056-42, 62056-46, 62056-53, 62056-61, 62056-62.

## Meter Settings

| Step | M-Bus  | EQ-Bus   |
|------|--|--|
| 5    | Press <input type="checkbox"/> once to get to the next menu. The display will show the address. See <i>Table 4:5</i> for address range. Set address.                 | Press <input type="checkbox"/> once to get to the next menu. The display will show the address. See <i>Table 4:5</i> for address range. Set address. |
| 6    | Press <input type="checkbox"/> once to get to the next menu. The display will show the access level. See <i>Table 4:5</i> for options. Set the access level.         | Press <input type="checkbox"/> once to get to the next menu. The display will show the Oct. TO. See <i>Table 4:5</i> for options. Set Oct. TO.       |
| 7    | Press <input type="checkbox"/> once to get to the next menu. The display will show the Send status info. See <i>Table 4:5</i> for options. Set the send info status. | Press <input type="checkbox"/> once to get to the next menu. The display will show the Inac. TO. See <i>Table 4:5</i> for options. Set Inac. TO.     |
|      | Press <input type="checkbox"/> once to get to the next menu. The display will show if the password is to be reset. See <i>Table 4:5</i> for options. Set the option. | Press <input type="checkbox"/> once to get to the next menu. The display will show password reset option. Set if the password shall be reset or not. |
|      | Press <input type="checkbox"/> once to get to the next menu. The display will show the upgrade mode. See <i>Table 4:5</i> for options. Set the upgrade mode.         |  |

### Protocol details

The following table shows the intervals and options for the different protocols:

**Table: 4:5**

| Protocol                          | Access level | Upgrade mode | Send Status Info | Reset password | Parity          | Baudrate  | Address  | Inter octet timeout (ms) | Inactivity timeout (ms) |
|-----------------------------------|--------------|--------------|------------------|----------------|-----------------|---|----------|--------------------------|-------------------------|
| EQ-Bus (when used through RS-485) | -            | -            | -                | Yes, No        | -               | 1200, 2400, 4800, 9600, 19200, 38400, 57600, 115200, 125000, 230400, 250000, 460800 | 16-16381 | 20-6000                  | 0-2000                  |
| Modbus (when used through RS-485) | -            | -            | -                | -              | None, Odd, Even | 1200, 2400, 4800, 9600, 19200, 38400, 57600, 115200                                 | 1-247    | -                        | -                       |

| Protocol                           | Access level           | Upgrade mode       | Send Status Info           | Reset password | Parity | Baudrate  | Address | Inter octet timeout (ms) | Inactivity timeout (ms) |
|------------------------------------|------------------------|--------------------|----------------------------|----------------|--------|---|---------|--------------------------|-------------------------|
| M-Bus (when used through IR-Side)  | Open, Password, Closed | Active, Not Active | Always, Never, When not OK | Yes, No        | -      | 2400, 4800, 9600, 19200, 38400                                      | 1-250   | -                        | -                       |
| EQ-Bus (when used through IR-Side) | -                      | -                  | -                          | Yes, No        | -      | 1200, 2400, 4800, 9600, 19200, 38400, 57600, 115200, 125000, 230400 |         |                          |                         |

#### 4.1.11 Setting Upgrade Consent

Upgrade Consent can be set to *Allowed* or *Not Allowed*. Setting it to *Allowed* means you agree to updates of the meter. Setting it to *Not Allowed* means no upgrades will take place.

To set Upgrade Consent, perform the following steps:

1. Choose the Settings icon in the main menu, press **OK**.
2. Choose “Upgrade Consent” (Upgr.Cons on the display), press **OK**.
3. Press **SET** to set Upgrade Consent.

#### 4.1.12 Setting Pulse LED

To set pulse LED, perform the following steps:

1. Choose the Settings icon in the main menu, press **OK**.
2. Choose “Pulse LED” (Puls.LED on the display), press **OK**.
3. Press **SET** to set the type of energy, active or reactive, that the LED shall indicate on.

#### 4.1.13 Setting Tariff

The tariff source can be set to input, clock or communication. To set the tariffs, perform the following steps:

| Step | Input  | Clock  | Communication  |
|------|--|--|--|
| 1    | Choose the Settings icon in the main menu, press <b>OK</b> . | Choose the Settings icon in the main menu, press <b>OK</b> . | Choose the Settings icon in the main menu, press <b>OK</b> . |
| 2    | Choose “Tariff”, press <b>OK</b> .                           | Choose “Tariff”, press <b>OK</b> .                           | Choose “Tariff”, press <b>OK</b> .                           |

| Step | Input   | Clock  | Communication   |
|------|---|--|---|
| 3    | Press <input type="button" value="SET"/> and choose Input.  | Press <input type="button" value="SET"/> and choose Clock. If the display says "Config found No reset" then reset the configuration by pressing <input type="button" value="SET"/> and choosing "Reset"  | Press <input type="button" value="SET"/> and choose Comm. |
| 4    | Use <input type="button" value="▼"/> to toggle to the first configuration. Four configurations are available. Set the tariff that shall be active for each configuration. | Press <input type="button" value="▼"/> to get to the next page.  | The tariff source is now set for communication.           |
| 5    | -   | Set the desired tariffs with start-time and if the tariff is to be used or not. Up to eight tariff switch times can be set, four for weekdays and four for weekends. Set at least one tariff for weekdays (Mon-Fri) and one for weekends (Sat-Sun) even if the values are the same | -   |

### 4.1.14 Setting Previous Values

To set set the previous values, perform the following steps:

1. Choose the Settings icon in the main menu, press .
2. Choose "Previous Values" (Prev.Val. on the display), press .
3. Perform the setting. The options are day, week and month.
4. If setting week, use  to go to the next step.
5. Set what week-day the snapshot of the values will be taken.

### 4.1.15 Setting Load Profile

To set the load profile, perform the following steps:

1. Choose the Settings icon in the main menu, press .
2. Choose "Load Profiles" (Load Pro on the display), press .
3. The first page will show the interval for the quantity active energy imported (Act.Imp.Tot on the display). Up to eight channels (pages) are available to configure, see table below.

| Page | Quantity                       | On display    | Predefined value |
|------|--------------------------------|---------------|------------------|
| 1/8  | Active Energy Imported total   | Act.Imp.Tot   | 1 hours          |
| 2/8  | Active Energy Exported Total   | Act.Exp.Tot   | 1 hours          |
| 3/8  | Reactive Energy Imported Total | React.Imp.Tot | 1 hours          |
| 4/8  | Reactive Energy Exported Total | React.Exp.Tot | 1 hours          |
| 5/8  | Input Counter 1                | Inp.Ctr 1     | 1 hours          |
| 6/8  | Input Counter 2                | Inp.Ctr 2     | 1 hours          |



| Page | Quantity        | On display | Predefined value |
|------|-----------------|------------|------------------|
| 7/8  | Input Counter 3 | Inp.Ctr 3  | 1 hours          |
| 8/8  | Input Counter 4 | Inp.Ctr 4  | 1 hours          |

4. Configure the desired channels.

When a configuration has been made, a reset may be required in order to perform a new configuration. To reset the intervals, toggle down to the reset page and perform a reset the same way as performing a setting.

#### 4.1.16 Setting Demand

The demand function enables measuring of up to 50 values (channels). Step 1-6 are general for the function and step 7-9 are specific for each channel.

To set the demand, perform the following steps:

1. Choose the Settings icon in the main menu, press .
2. Choose "Demand" (Demand on the display), press .
3. Set the period. The available choices are day, week and month. If choosing day, the starting point will be now and the ending point will be 00:00. If choosing month, the starting point will be now and the ending point will be the first of next month at 00:00. If choosing week, the starting point will be now and the ending point will be the set day at 00:00. If choosing week, press  to get to the page where the day is set. Press .
4. Set the interval that shall be measured. Press  to continue.
5. Set the subinterval that shall be measured. Press  to continue.
6. Set if the previous settings shall be reset. Press  to continue.
7. Set the quantity that shall be measured. Press  to continue.
8. Set the demand type. Press  to continue.
9. The demand level will be set automatically.

The first channel is now set. To set the next channel, repeat step 3-9. Up to 50 channels can be set.

#### 4.1.17 Resetting Resettable Registers

To reset registers, perform the following steps:

1. Choose the Settings icon in the main menu, press .
2. Choose "Resettable registers" (Rst.Reg on the display), press .
3. The display will show the different registers to reset. Depending on the meter type, the available choices are:

| Register                       | On the display |
|--------------------------------|----------------|
| Active Energy Imported Total   | Act.Imp        |
| Active Energy Exported Total   | Act.Exp        |
| Reactive Energy Imported Total | Rea.Imp        |
| Reactive Energy Exported Total | Rea.Exp        |

# Meter Settings

---

| Register  | On the display |
|-----------|----------------|
| Reset all | All            |

4. Toggle through the pages and reset the desired registers.

## Chapter 5: Technical Description

---

### Overview

This chapter contains technical descriptions of the meter functions. Depending of the meter type, the meter may contain all or a subset of the functions described in this chapter.

---

### In this chapter

The following topics are covered in this chapter:

|                                 |    |
|---------------------------------|----|
| 5.1 Energy Values .....         | 44 |
| 5.2 Instrumentation .....       | 46 |
| 5.3 Harmonics .....             | 48 |
| 5.3.1 Measuring Harmonics ..... | 50 |
| 5.4 Alarm .....                 | 52 |
| 5.5 Inputs and Outputs .....    | 53 |
| 5.5.1 Tariff Inputs .....       | 53 |
| 5.5.2 Pulse Outputs .....       | 54 |
| 5.6 Internal Clock .....        | 56 |
| 5.7 Logs .....                  | 57 |
| 5.7.1 System Log .....          | 57 |
| 5.7.2 Event Log .....           | 58 |
| 5.7.3 Net Quality Log .....     | 59 |
| 5.7.4 Audit Log .....           | 59 |
| 5.7.5 Settings Log .....        | 60 |
| 5.7.6 Event codes .....         | 60 |
| 5.8 Demand .....                | 62 |
| 5.9 Previous Values .....       | 64 |
| 5.10 Load Profile .....         | 66 |

### 5.1 Energy Values

---

#### General

The energy values are stored in energy registers. The different energy registers can be divided into:

- Registers containing active, reactive or apparent energy
- Registers containing different tariffs or total sum of all tariffs
- Registers containing energy per phase or total sum of all phases
- Resettable registers (possible to set to zero via buttons or communication command)
- Registers containing momentary or historical value

The energy values can be read via communication or directly in the display with the help of the buttons.

---

#### Primary value

In transformer connected meters with external current transformers, and sometimes also external voltage transformers, the total transformer ratio is taken into account for all energy registers, that is all energy registers store primary values.

---

#### Presentation of register values

In direct connected meters the energy is usually displayed with 7 digits in kWh/kvarh/KVAh with two decimals and displays one decimal less at overflow, that is it changes to one decimal at 100000.0 kWh and to no decimals at 1000000 kWh.

In transformer connected meters where primary values are displayed, the energy values can be rather big when the total transformer ratio is big. Normally the meter automatically adapts the unit and number of decimals displayed to the value.

In case the energy is displayed with fixed units and number of decimals the energy will "roll over" to zeros when the energy is incremented if all nines are displayed. The meter can however contain more digits internally, which can be read out via communication if the meter is equipped with a communication interface. See the example below where the value 2483756 is displayed, while the internal register contains 192483756.6.

**Image**

The following picture shows a display with fixed unit and numbers of decimals:



### 5.2 Instrumentation

#### Instrumentation functions

The following table shows the complete instrumentation functions of the A41/A42 meters. Depending on the meter type all or a subset of the following functions are available.

| Instrumentation                 | A41 | A42 |
|---------------------------------|-----|-----|
| Active power                    | X   | X   |
| Reactive power                  | X   | X   |
| Apparent power                  | X   | X   |
| Voltage                         | X   | X   |
| Current                         | X   | X   |
| Frequency                       | X   | X   |
| Power factor                    | X   | X   |
| Phase angle power               | X   | X   |
| Phase angle voltage             | X   | X   |
| Phase angle current             | X   | X   |
| Current quadrant                | X   | X   |
| THD voltage                     | X   | X   |
| Harmonics voltage (number 2-16) | X   | X   |
| THD current                     | X   | X   |
| Harmonics current (number 2-16) | X   | X   |

#### Accuracy

All instrumentation data accuracy is defined within the voltage range 20 % of the stated nominal voltage and within the current range 5 % of the base current to the maximum current.

The accuracy of all instrumentation data except the frequency and voltage and current phase-angles is the same as the stated energy metering accuracy. The accuracy for the voltage and current phase-angles is 2 degrees and 0.5 % for the frequency.

## 5.3 Harmonics

---

### General

The presence of harmonics in voltages and currents may cause a number of unwanted problems. This chapter describes the origin of harmonics, how the negative effects of harmonics can be eliminated and how harmonics is measured.

The harmonics data can be read via communication or directly in the display with the help of the buttons.

---

### Generation of harmonics

Generators in the power system produce a nearly pure sinusoidal voltage with a frequency near the stated system frequency, normally 50 or 60 Hz. Linear loads, consisting of pure resistors, capacitors and inductors, draw a pure sinusoidal current if the voltage over the load is pure sinusoidal.

A non-linear load, however, draws non-sinusoidal current resulting in a current consisting of several frequencies. One example of a common non-linear load are power supplies in electronic equipment which normally contains rectifier diodes which rectifies the incoming voltage and charges a capacitor. The power supply only draws current at the top of the sine wave when the rectified voltage exceeds the voltage over the capacitor. Another example of a non linear load is a thyristor controlled load, where the current normally is turned on at the voltage zero crossing and turned off sometimes during the sine wave.

These currents are all non-sinusoidal and can be divided into a fundamental part, which is the same as the mains frequency, and high frequency parts, that is harmonics, which have frequency that are integral multiples of the mains frequency.

Harmonics in the current will in turn cause harmonics in the voltage since the mains wires and the generator have an impedance causing a voltage drop that is proportional to the current. It should also be pointed out that if there is harmonics in the voltage, also a linear load will cause harmonics in the current, that have the same magnitude as the voltage harmonics. However, the origin of harmonics in the voltage are non-linear loads.

---

### Negative effects of harmonics

The presence of harmonics in voltages and currents can cause a number of problems:

- Increased cable losses. At higher frequencies skin and proximity effects increases, resulting in increased losses.
- High current in the neutral wire.
- Motor efficiency and product lifetime will decrease if the voltage contain harmonics.
- In transformers, harmonics will cause higher wire, hysteresis and eddy losses, which could result in efficiency losses up to 50%.
- Voltage harmonic can give higher peak voltages (higher crest factor), causing overvoltage protection devices to trip and in worst case destruction of devices.
- Voltage harmonic can result in decreased product lifetime and in worst case destruction of capacitor banks (used for power factor correction).
- Voltage harmonic can cause malfunction of devices controlled by the voltage, often zero crossings (voltage harmonics can give extra zero crossings).
- Voltage harmonics can produce disturbances within devices having its power supply connected to the mains causing problems.

---

### Eliminating negative effects of harmonics

Because of the negative effects of harmonics it may be necessary to take actions to decrease the problems. This can be either done by decreasing the harmonics, and/or taking actions that decrease the negative effects of the harmonics.

---

### Suggested actions

- Increase the size of the neutral conductor if the current is abnormally high due to harmonics.
  - Install appropriate filters to isolate loads with high current harmonics.
  - Install filters to protect to protect loads that are sensitive to voltage harmonics.
  - Oversize generators, motors and transformers to better cope with harmonics.
  - Substitute equipment for equipment that generates less current harmonics and is less sensitive to voltage harmonics.
-



### 5.3.1 Measuring Harmonics

**General** To detect and eliminate the problems related to presence of harmonics, it's generally necessary to measure the harmonics. Meters that have harmonic measurement enabled measure harmonics on all voltages and currents up to the 16th harmonic and calculates the total harmonic distortion (THD).

**Measuring** Measurement of the harmonics is done sequentially, one at a time, and approximately two harmonic numbers are measured every second.

Each harmonic is calculated according to:

$$I_n / I_f \cdot 100\%$$

and the total current harmonic distortion for the harmonics measured is calculated according to:

$$\sqrt{\sum_{n=2}^{16} I_n^2} / I_f \cdot 100\%$$

where  $I_f$  is the fundamental current and  $I_n$  is the current for harmonics with number n.

At each measurement the harmonic is set to 0 if the rms value of the current is below a certain lower limit (normally 5% of the basic current).

**Folding distortion** Since the meter have limited sampling frequency, presence of harmonics over the 20:th harmonic (1 kHz at 50 Hz line frequency) will result in folding distortion and can affect the harmonic measurement accuracy negatively.

Due to the possible presence of folding distortion and the fact that harmonics is measured sequentially, one at a time, it is recommended that the harmonic measurement results of the meter is used as a tool to detect presence of harmonics and not as an exact instrument to get exact results.

**Frequency measurement** Measuring harmonics require a valid frequency measurement. If the frequency measurement is uncertain, the harmonic measurement will not be performed. To get a valid measurement the meter uses a retry scheme. If the retry scheme does not give a valid measurement the harmonic will be marked as "not available".

## Technical Description

---

### Accuracy

The accuracy of the current harmonics varies with the harmonic amplitude and is valid only provided there is no harmonics above the 16th harmonic.

| Harmonic Number | 1% < Distortion ≤ 5% | 5% < Distortion ≤ 10% | 10% < Distortion ≤ 20% | 20% < Distortion ≤ 50% | 50% < Distortion ≤ 100% |
|-----------------|----------------------|-----------------------|------------------------|------------------------|-------------------------|
| 2               | ± 0.5%*              | ± 1.0                 | ± 2%                   | ± 4%                   | ± 6%                    |
| 3               | ± 0.7%*              | ± 1.5%                | ± 3%                   | ± 6%                   | ± 9%                    |
| 4               | ± 1.0%               | ± 2.0%                | ± 4%                   | ± 8%                   | ± 12%                   |
| 5               | ± 1.2%               | ± 2.5%                | ± 5%                   | ± 10%                  | ± 15%                   |
| 6               | ± 1.5%               | ± 3.0%                | ± 6%                   | ± 12%                  | ± 18%                   |
| 7               | ± 1.7%               | ± 3.5%                | ± 7%                   | ± 14%                  | ± 21%                   |
| 8               | ± 2.0%               | ± 4.0%                | ± 8%                   | ± 16%                  | ± 24%                   |
| 9               | ± 2.5%               | ± 5.0%                | ± 10%                  | ± 20%                  | ± 30%                   |
| 10              | ± 2.5%               | ± 5.0%                | ± 10%                  | ± 20%                  | ± 30%                   |
| 11              | ± 2.5%               | ± 5.0%                | ± 10%                  | ± 20%                  | ± 30%                   |
| 12              | ± 2.5%               | ± 5.0%                | ± 10%                  | ± 20%                  | ± 30%                   |
| 13              | ± 2.5%               | ± 5.0%                | ± 10%                  | ± 20%                  | ± 30%                   |
| 14              | ± 2.5%               | ± 5.0%                | ± 10%                  | ± 20%                  | ± 30%                   |
| 15              | ± 2.5%               | ± 5.0%                | ± 10%                  | ± 20%                  | ± 30%                   |
| 16              | ± 2.5%               | ± 5.0%                | ± 10%                  | ± 20%                  | ± 30%                   |

\* For distortion levels below 1% the absolute uncertainty is ± 0.5%.

---

## 5.4 Alarm

### General

The purpose of the alarm function is to enable monitoring of quantities in the meter. Monitoring can be set to high or low level detection. High level detection gives an alarm when the level of a quantity goes above the set level. Low level detection gives an alarm when the value goes below the set level.

It is possible to configure 25 alarms. Configuration can be done via communication or with the buttons directly on the meter.

### Quantities

Depending on the meter type all or a subset of the following quantities can be monitored:

|                |                  |
|----------------|------------------|
| Voltage        | Apparent power   |
| Current        | Power factor     |
| Active power   | Harmonic voltage |
| Reactive power | Harmonic current |

### Functional description

When the value of the monitored quantity passes the activation level, and remains there for a period of time equal or longer than the specified time delay, the alarm is activated. In the same way, the alarm is deactivated when the value passes the deactivation level and remains there for a time equal or longer than the specified time delay.

If the activation level is higher than the deactivation level, the alarm is activated when the value of the monitored quantity is higher than the activation level.

If the activation level is lower than the deactivation level, the alarm is activated when the value of the monitored quantity is lower than the activation level.

### 5.5 Inputs and Outputs

---

**General**

Inputs/outputs are built with optocouplers and are galvanically isolated from other meter electronics. They are polarity independent and handle both DC and AC voltage.

An input that is not connected equals having its voltage off.

The equivalent circuitry of the outputs is an ideal relay in series with a resistor.

---

**Functionality of inputs**

The inputs count pulses, register activity and current status and the data can be read directly on the meter display or via communication

Register activity can be reset via communication or via the buttons directly on the meter.

---

**Functionality of outputs**

The outputs can be controlled by communication, alarm or by the internal clock.

---

#### 5.5.1 Tariff Inputs

---

**Tariff control**

On meters with tariff functionality, the tariffs are controlled either via communication, the internal clock or by 1 or 2 tariff inputs.

Tariff control via inputs is done by applying a proper combination of "voltage" or "no voltage" to the input(s). Each combination of "voltage"/"no voltage" will result in that the meter will register the energy in a particular tariff register.

In combined meters with both active and reactive metering, both quantities are controlled by the same inputs and the active tariff for active and reactive energy will always be the same.

---

**Indication of active tariff**

The active tariff is displayed on the LCD by the text "Tx" in the status field, where x is the tariff number. The active tariff can also be read via communication.

---

**Input coding, meters with 4 tariffs**

The coding of the inputs is binary. The following table describes the default coding.

| Input 4 | Input 3 | Tariff |
|---------|---------|--------|
| OFF     | OFF     | = T1   |
| OFF     | ON      | = T2   |
| ON      | OFF     | = T3   |
| ON      | ON      | = T4   |

**Input coding, meters with 2 tariffs**

The coding of the inputs is binary. The following table describes the default coding.

| Input 3 | Tariff |
|---------|--------|
| OFF     | = T1   |
| ON      | = T2   |

**5.5.2 Pulse Outputs**

**About pulse outputs**

Meters equipped with pulse outputs may have up to 4 outputs.

On the pulse outputs the meter sends out a specified number of pulses (pulse frequency) per kWh (kvarh for reactive pulse outputs).

The pulse outputs are primary, which means that the pulses are sent out in proportion to the true primary energy, taking current and voltage transformer ratios (CT and VT ratio) programmed on the meter into account.

For direct connected meters no external transformers are used and the amount of pulses sent out are in proportion to the energy flowed through the meter.

**5.5.2.1 Pulse Frequency and Pulse length**

**General**

Pulse frequency and pulse length can be set via the buttons on the meter or via communication. If the meter have more than 1 pulse output, all outputs will have the same pulse frequency and pulse length.

**Pulse frequency**

The pulse frequency is configurable and can be set to a value between 1-9999 impulses. The value must be an integer. The unit is selectable and may be set to imp/kWh, imp/Wh or imp/MWh.

**Pulse length**

The pulse length can be set to a value between 10-990 ms.

**Deciding pulse frequency/length**

If the power is too high for a certain pulse length and pulse frequency, there is a risk that the pulses may go into one another. If this happens the meter will emit a new pulse (relay closed) before the previous one has terminated (relay open) and the pulse will be missed. In worst case the relay may be closed at all times.

To avoid this problem a calculation should be made to work out the maximum pulse frequency allowed at a particular site based upon an estimated maximum power and the meter's pulse output data.

### Formula

The formula to use for this calculation is:

$$\text{Max pulse frequency} = 1000 * 3600 / U / I / n / (P_{\text{pause}} + P_{\text{length}})$$

where U and I is the estimated maximum element voltage (in volts) and current (in amperes), n the number of elements (1 - 3). Plength and Ppause are the pulse length and the required pulse pause (in seconds). A reasonable minimum pulse length and pulse pause is 30 ms which conforms to the S0 and IEC standard.



**Note** – U and I have to be the primary values in a transformer connected meter if the CT and VT for the external transformers are programmed into the meter.

### Example 1

In a direct connected 3-element meter with estimated maximum voltage and current of 250 V and 65 A and pulse length 100 ms and required pulse pause 30 ms, the maximum allowed pulse frequency will be:

$$1000 * 3600 / 250 / 65 / 3 / (0.030 + 0.100) = 568 \text{ impulses / kWh (kvarh)}$$

### Example 2

In a transformer connected 3-element meter with estimated maximum voltage and current of  $63 * 100 \text{ V} = 6300 \text{ V}$  (VT ratio 100) and  $6 * 50 \text{ A} = 300 \text{ A}$  (CT ratio 50) and pulse width 100 ms and required pulse pause 30 ms the maximum allowed pulse frequency will be:

$$1000 * 3600 / 6300 / 300 / 3 / (0.030 + 0.100) = 6.16 \text{ impulses / kWh (kvarh)}$$

---

## 5.6 Internal Clock

---

|                                 |  |
|---------------------------------|--|
| <b>General</b>                  | Meter with a built-in clock automatically keeps track of leap year and daylight savings time (DST). The use of DST is optional. Time is controlled by a quartz crystal real time clock.                                      |
| <b>Time and date</b>            | Time and date can be set via communication, or with the buttons directly on the meter.   |
| <b>Time dependant functions</b> | <ul style="list-style-type: none"><li>• Load profile</li><li>• Maximum demand</li><li>• Minimum demand</li><li>• Previous values</li><li>• Event log</li><li>• Outputs controlled by time</li><li>• Tariff control</li></ul> |
| <b>Backup of clock</b>          | In case of power failure a super capacitor backs up the clock for at least 48 hours.   |

---

### 5.7 Logs

---

#### General

The meter contains a total of five different logs:

- System Log
- Event Log
- Net Quality Log
- Audit log
- Settings Log

Log events can be read via communication or directly in the display of the meter.

A maximum of 500 log events can be stored in the System Log, the Event Log and the Net Quality Log. When the maximum number of events for a log is reached, the oldest events will be overwritten.

A maximum of 40 log events can be stored in the Audit Log. When the maximum number of events for this log is reached, no more events can be stored. A new firmware upgrade attempt will be unsuccessful because no more log events can be stored.

A maximum of 80 log events can be stored in the Settings Log. When the maximum number of events for this log is reached, no more events can be stored. A new setting for either CT/VT or number of elements will not be accepted because no more log events can be stored.

It is possible to delete all entries in the System Log, The Event Log and the Net Quality Log via communication.

---

#### 5.7.1 System Log

This log stores events that relate to errors in the meter.

---

#### Contents

The following information is stored in an event:

- Date and time
- Event Code
- Duration

The following events are stored in this log:

- Program CRC Error - Error when checking firmware consistency.
  - Persistent Storage Error - Data stored in long-term memory is corrupt.
  - RTC Circuit Error - Error when trying to read date and time from real-time clock.
-



### 5.7.2 Event Log

This log stores events that relate to alarms and configuration warnings.

---

#### Contents

The following information is stored in an event:

- Date and Time
- Event Code
- Duration

The following events are stored in this log:

- Date Not Set Warning - Date has not been configured for RTC.
  - Time Not Set Warning - Time has not been configured for RTC.
  - Negative Total Power - Power is measured as negative.
  - Alarm Current
  - Alarm Active Power
  - Alarm Reactive Power
  - Alarm Apparent power
  - Alarm Power Factor
- 

### 5.7.3 Net Quality Log

This log stores alarms and information that relates to net quality.

---

#### Contents

The following events are stored in this log

- Voltage Missing Warning - Voltage is missing
  - Frequency Warning - Net frequency is not stable
  - Alarm Voltage
  - Alarm Harmonic Voltage
-

### 5.7.4 Audit Log

The Audit Log stores an event after an attempt has been made to upgrade the firmware.

---

#### Contents

The following information is stored in an event:

- Date and Time
  - Firmware version
  - Active Energy import
  - Active Energy import Tariff 1
  - Active Energy import Tariff 2
  - Active Energy import Tariff 3
  - Active Energy import Tariff 4
  - Active Energy Export
  - Firmware Upgrade status
- 

### 5.7.5 Settings Log

This log stores an event when the transformer ratio is reconfigured.

---

#### Contents

The following information is stored in an event:

- Date and Time
  - Firmware version
  - Active Energy import
  - Active Energy import Tariff 1
  - Active Energy import Tariff 2
  - Active Energy import Tariff 3
  - Active Energy import Tariff 4
  - Active Energy Export
  - CT-Value
  - VT-Value
- 

### 5.7.6 Event codes

---

#### Description

The following table describes the event codes that may occur in the System log, the Event log and the Net quality log:

---

| Event code | Event                    |
|------------|--------------------------|
| 41         | Program CRC error        |
| 42         | Persistent storage error |
| 53         | RTC circuit error        |

| <b>Event code</b> | <b>Event</b>                     |
|-------------------|----------------------------------|
| 1000              | Voltage Missing Warning          |
| 1004              | Negative Power Element 1 Warning |
| 1007              | Negative Total power Warning     |
| 1008              | Frequency Warning                |
| 1010              | Date Not Set Warning             |
| 1011              | Time Not Set Warning             |
| 2013              | Alarm 1 active                   |
| 2014              | Alarm 2 active                   |
| 2015              | Alarm 3 active                   |
| 2016              | Alarm 4 active                   |
| 2017              | Alarm 5 active                   |
| 2018              | Alarm 6 active                   |
| 2019              | Alarm 7 active                   |
| 2020              | Alarm 8 active                   |
| 2021              | Alarm 9 active                   |
| 2022              | Alarm 10 active                  |
| 2023              | Alarm 11 active                  |
| 2024              | Alarm 12 active                  |
| 2025              | Alarm 13 active                  |
| 2026              | Alarm 14 active                  |
| 2027              | Alarm 15 active                  |
| 2028              | Alarm 16 active                  |
| 2029              | Alarm 17 active                  |
| 2030              | Alarm 18 active                  |
| 2031              | Alarm 19 active                  |
| 2032              | Alarm 20 active                  |
| 2033              | Alarm 21 active                  |
| 2034              | Alarm 22 active                  |
| 2035              | Alarm 23 active                  |
| 2036              | Alarm 24 active                  |
| 2037              | Alarm 25 active                  |

### 5.8 Demand

#### General

The demand functionality is used to measure and store the maximum and minimum demands of different quantities in the meter. Time is divided into intervals of a certain length in which the mean values of a set of selected quantities are measured.

Demand can be configured via Modbus and EQ-bus communication or via the buttons on the meter.



**Note** – Before any demand values can be stored, time/date must be set.

Changing time/ date will store the current period and start a new one.

If a power fail occurs that lasts over the end of an ongoing period, the period will be stored when the meter powers up again and a new period will start. If date/time is not set when the meter powers up again, demand will enter a waiting state until time/date is set.

---

#### Interval length

The interval lengths for demand can be one of the following: 1, 2, 5, 10, 15, 20, 30, 60 minutes.

---

#### Storing periods

When the last interval of an ongoing period has finished, the maximum- and/or minimum values are stored and a new period starts.

The length of a demand period can be a day, a week or a month.

Demand has 50 channels which can be configured individually. Each channel can store up to 200 periods. A stored period contains the demand value, the date/time of the period and the date/time of the interval when the demand value was measured. All channels use the same interval, subinterval and period length. Individual channel parameters are type of demand which have the four choices maximum, minimum, maximum sliding or minimum sliding and the number of the demand with the three choices first, second or third (max/min).

The period/interval date and time is stored as end of period/interval. For instance, if a period starts 2010.01.01 00:00.00 and ends 2010.01.02 00:00.00, then the stored period will be 2010.01.02 00:00.00.

If there is no free memory space available, the oldest period will be erased to make room for the most recent one.

Stored periods can be read via communication or directly on the display.

An ongoing period can be ended and a new one started by sending a “freeze demand” via communication.

It is also possible to erase all stored periods by sending a “Reset Demand” command via communication.

If the time is set backward within an interval the calculation of demand for that interval is restarted if the channel is configured to store a maximum value (as the

actual time for that interval will be longer than the interval time which could result in a too big demand value). For the same reason the calculation of demand for an interval is restarted if the channel is configured to store a minimum value and the time is set forward within the interval or into another interval.

**Demand values**

Each demand quantity is individually configurable to store up to the three highest or lowest demand values, where each value use one demand channel configured to use first, second and third maximum/minimum. If demand is configured to store only one maximum interval, then only the interval with the maximum peak will be recorded. If a demand quantity is configured to store three maximum intervals the intervals with the three highest peaks are recorded.

**Sliding demand**

A demand channel can also be configured as maximum sliding demand or minimum sliding demand. A sub-interval time is set which divides the interval into a circular array with a new mean value calculated at the end of every sub-interval. The selectable sub-interval times for demand is a subset of the interval times and evenly divisible with the selected interval time.

**Selectable quantities**

Depending on the meter type all or a subset of the following quantities can be selected.

|                               |                               |
|-------------------------------|-------------------------------|
| ACTIVE POWER IMPORT TOTAL     | REACTIVE POWER IMPORT TARIFF2 |
| REACTIVE POWER IMPORT TOTAL   | REACTIVE POWER IMPORT TARIFF3 |
| APPARENT POWER IMPORT TOTAL   | REACTIVE POWER IMPORT TARIFF4 |
| ACTIVE POWER IMPORT TARIFF1   | VOLTAGE L1                    |
| ACTIVE POWER IMPORT TARIFF2   | HARMONIC VOLTAGE L1           |
| ACTIVE POWER IMPORT TARIFF3   | CURRENT L1                    |
| ACTIVE POWER IMPORT TARIFF4   | HARMONIC CURRENT L1           |
| REACTIVE POWER IMPORT TARIFF1 | PULSE INPUT COUNTERS          |

The value is the mean value of the interval. The unit for the pulse input counters are pulses per hour (for example if 2 pulses were registered in a 15 minute interval the value for the interval will be 8 pulses per hour).

## 5.9 Previous Values

### General

At the end of a defined period, up to 50 configurable channels, which can contain energy register values, input counter values and currency/CO<sub>2</sub> values, are stored together with the time/date for the end of the period.

Previous values can be configured via Modbus and EQ-bus communication or via the buttons on the meter.



**Note** – Before any previous values can be stored, time/date must be set.

Changing time/date into another period than the pending period will store the current period and start a new one.

If a power fail occurs that lasts over the end of an ongoing period, the period will be stored when the meter powers up again and a new period will start. If the meter have lost time and date/time is not set when the meter powers up again, previous values will enter a waiting state until time/date is set.

### Storing periods

Previous values has 50 channels which can be configured individually via communication. Each channel can store up to 200 periods.

The period length can be a day, a week or a month and can be configured via Modbus and EQ-bus communication or via the buttons on the meter.

The period date and time is stored as end of period. For instance, if a period starts 2010.01.01 00:00.00 and ends 2010.01.02 00:00.00, then the stored period will be 2010.01.02 00:00.00.

Stored periods can be read via communication or directly on the display.

If there is no free memory space available, the oldest period will be erased to make room for the most recent one.

It is possible to erase all stored periods by sending a “Reset Previous Values” command via communication.

### Selectable quantities

Depending on the meter type all or a subset of the following quantities can be selected.

|                                       |                                |
|---------------------------------------|--------------------------------|
| ACTIV ENERGY IMPORT TOTAL             | ACTIVE ENERGY EXPORT TARIFF1   |
| ACTIVE ENERGY EXPORT TOTAL            | ACTIVE ENERGY EXPORT TARIFF2   |
| REACTIVE ENERGY IMPORT TOTAL          | ACTIVE ENERGY EXPORT TARIFF3   |
| REACTIVE ENERGY EXPORT TOTAL          | ACTIVE ENERGY EXPORT TARIFF4   |
| APPARENT ENERGY IMPORT TOTAL          | REACTIVE ENERGY EXPORT TARIFF1 |
| APPARENT ENERGY EXPORT TOTAL          | REACTIVE ENERGY EXPORT TARIFF2 |
| RESETTABLE ACTIVE ENERGY IMPORT TOTAL | REACTIVE ENERGY EXPORT TARIFF3 |
| RESETTABLE ACTIVE ENERGY EXPORT TOTAL | REACTIVE ENERGY EXPORT TARIFF4 |

|   |                                   |
|---|-----------------------------------|
| RESETTABLE REACTIVE ENERGY IMPORT TOTAL | ACTIVE ENERGY NET TOTAL           |
| RESETTABLE REACTIVE ENERGY EXPORT TOTAL | REACTIVE ENERGY NET TOTAL         |
| ACTIVE ENERGY IMPORT TARIFF1            | APPARENT ENERGY NET TOTAL         |
| ACTIVE ENERGY IMPORT TARIFF2            | ACTIVE ENERGY CURRENCY CONVERSION |
| ACTIVE ENERGY IMPORT TARIFF3            | ACTIVE ENERGY CO2 CONVERSION      |
| ACTIVE ENERGY IMPORT TARIFF4            | PULSE INPUT COUNTERS              |
| REACTIVE ENERGY IMPORT TARIFF1          |                                   |
| REACTIVE ENERGY IMPORT TARIFF2          |                                   |
| REACTIVE ENERGY IMPORT TARIFF3          |                                   |
| REACTIVE ENERGY IMPORT TARIFF4          |                                   |

---

### 5.10 Load Profile

---

#### General

Load profile is a collection of 8 channels that can store register values for register quantities or interval averages for instrumentation quantities. Through Modbus and EQ-bus communication each channel can be assigned one register or instrumentation quantity, a time interval and a maximum amount of snapshots to be stored in the channel.

Interval length per channel can also be configured via the buttons on the meter.

The load profiles can be read via communication or directly on the display.

The stored register values in a channel are read as a list of register snapshots and for instrumentation values as a list of interval averages.



**Note** – Before any load profiles can be stored, time/date must be set.

If a power failure occurs that lasts over the end of an interval, the value will be stored when the meter powers up again only if time/date are still correct.

---

#### Intervals

The interval lengths for Load Profiles can be one of the following: 1, 2, 5, 10, 15, 20, 30, 60, 120, 180, 240, 360, 480, 720 or 1440 minutes.

If the interval is evenly divisible with an hour, the start of each hour will mark the start of a new interval. If the interval is evenly divisible with a day, the start of a day will mark the start of a new interval.

The interval date and time is stored as end of interval. For instance, if an interval starts 2010.01.01 00:00.00 and ends 2010.01.01 00:15.00, then the stored period will be 2010.01.01 00:15.00.

---

#### Example 1

Interval is set to 120 minutes, current time 12:13. Evenly divisible with a day. The next interval end/start times will be: 14:00, 16:00, 18:00, 20:00, 22:00, 00:00, etc,...

---

#### Example 2

Interval is set to 15 minutes, current time 12:13. Evenly divisible with an hour. The next interval end/start times will be: 12:15, 12:30, 12:45, 13:00, 13.15, 13.30 etc,...

---

#### Channels and snapshots

Each channel has its own interval configuration. That means that snapshots in one channel can be stored with a different interval than snapshots in another channel.

Each channel can be assigned a number of snapshots. A total of 40 000 snapshots can be stored in a load profile. All channels in a load profile share the same memory area, which means that one channel can store 40 000 snapshots if no other



channel is used. By default the meter has all 8 channels activated with 5000 snapshots assigned to each.

If there is no free memory space available, the oldest snapshot will be erased to make room for the most recent one.

It is possible to erase all snapshots in all channels by sending a “Reset Load profile” command via communication. Via Modbus and EQ-bus communication it is also possible to erase all snapshots in a particular channel.

---

### Load profile data

Each load profile data value is associated with a status value. The status value gives information such as:

- Interval is longer or shorter than defined length
- Power outage occurred during interval
- Overflow in data
- Time was changed during interval
- Data not available
- Error in data

---

### Selectable quantities

Depending on the meter type all or a subset of the following quantities can be selected:

|                              |                                   |
|------------------------------|-----------------------------------|
| ACTIVE ENERGY IMPORT TOTAL   | ACTIVE ENERGY CURRENCY CONVERSION |
| ACTIVE ENERGY EXPORT TOTAL   | ACTIVE ENERGY CO2 CONVERSION      |
| REACTIVE ENERGY IMPORT TOTAL | VOLTAGE L1*                       |
| REACTIVE ENERGY EXPORT TOTAL | CURRENT L1*                       |
| APPARENT ENERGY IMPORT TOTAL | POWER FACTOR TOTAL*               |
| APPARENT ENERGY EXPORT TOTAL | PULSE INPUT COUNTERS              |

\*The values are mean values of the intervals.

---



## Chapter 6: Technical data

---

### Overview

This chapter contains technical data and product drawings.

---

---

### In this chapter

The following topics are covered in this chapter:

|                                    |    |
|------------------------------------|----|
| 6.1 Technical Specifications ..... | 68 |
| 6.2 Physical dimensions .....      | 72 |

### 6.1 Technical Specifications

#### Specifications for A41 direct connected meters

|                                    |   |
|------------------------------------|---|
| <b>Voltage/current inputs</b>      |   |
| Nominal voltage                    | 230 V AC  |
| Voltage range                      | 57.7 - 288 V AC (-20%-+15%)   |
| Power dissipation voltage circuits | 0.8 VA (0.8 W) at 230 V AC  |
| Power dissipation current circuits | 0.007 VA (0.007 W) at $I_{ref}$   |
| Base current $I_b$                 | 5 A   |
| Reference current $I_{ref}$        | 5 A   |
| Transitional current $I_{tr}$      | 0.5 A   |
| Maximum current $I_{max}$          | 80 A  |
| Minimum current $I_{min}$          | 0.25 A  |
| Starting current $I_{st}$          | < 20 mA   |
| Terminal wire area                 | 1-25 mm <sup>2</sup>  |
| Recommended tightening torque      | 3.0 Nm  |
| <b>General data</b>                |   |
| Frequency                          | 50 or 60 Hz $\pm$ 5%  |
| Accuracy                           | 1%, 2%  |
| Accuracy of internal clock         | 5 ppm at reference temperature 25°C   |
| Display                            | 96x64 pixels, view area 39x26 mm  |
| <b>Mechanical</b>                  |   |
| Material                           | Polycarbonate in transparent front glass, bottom case, upper case and terminal cover. Glass reinforced polycarbonate in terminal block. |
| Weight                             | 0.23 kg   |
| <b>Environmental</b>               |   |
| Operating temperature              | -40°C - +70°C   |
| Storage temperature                | -40°C - +85°C   |
| Humidity                           | 75% yearly average, 95% on 30 days/year   |
| Resistance to fire and heat        | Terminal 960°C, cover 650°C (IEC 60695-2-1)   |
| Resistance to water and dust       | IP 20 on terminal block without protective enclosure and IP 51 in protective enclosure, according to IEC 60529.                         |
| Mechanical environment             | Class M2 in accordance with the Measuring Instrument Directive (MID), (2014/32/UE).   |
| Electromagnetic environment        | Class E2 in accordance with the Measuring Instrument Directive (MID), (2014/32/UE).   |
| <b>Outputs</b>                     |   |
| Current                            | 2 - 100 mA  |
| Voltage                            | 5 - 240 V AC/DC. For meters with only 1 output, 5 - 40 V DC.  |
| Pulse output frequency             | Prog. 1 - 9999 imp/MWh, 1 - 9999 imp/kWh, 1 - 9999 imp/Wh   |
| Pulse length                       | 10 - 990 ms   |

|  |  |
|--|--|
| Terminal wire area                       | 0.5 - 1 mm <sup>2</sup>  |
| Recommended tightening torque            | 0.25 Nm  |
| <b>Inputs</b>                            |  |
| Voltage                                  | 0-240 V AC/DC  |
| Off                                      | 0-5 V AC/DC  |
| ON                                       | 57-240 V AC, 24-240 V DC   |
| Min. pulse length and pulse pause        | 30 ms  |
| Terminal wire area                       | 0.5 - 1 mm <sup>2</sup>  |
| Recommended tightening torque            | 0.25 Nm  |
| <b>Communication</b>                     |  |
| Terminal wire area                       | 0.5 - 1 mm <sup>2</sup>  |
| Recommended tightening torque            | 0.25 Nm  |
| M-Bus                                    | EN 13757-2, EN 13757-3   |
| Modbus                                   | Modbus Application Protocol Specification V1.1b  |
| EQ-Bus                                   | IEC 62056-42, 62056-46, 62056-53, 62056-61, 62056-62   |
| <b>Pulse indicator (LED)</b>             |  |
| Pulse Frequency                          | 1000 imp/kWh   |
| Pulse length                             | 40 ms  |
| <b>EMC compatibility</b>                 |  |
| Impulse voltage test                     | 6 kV 1.2/50µs (IEC 60060-1)  |
| Surge voltage test                       | 4 kV 1.2/50µs (IEC 61000-4-5)  |
| Fast transient burst test                | 4 kV ( IEC 61000-4-4 )   |
| Immunity to electromagnetic HF-fields    | 80 MHz - 2 GHz at 10 V/m (IEC 61000-4-3)   |
| Immunity to conducted disturbance        | 150kHz – 80MHz, ( IEC 61000-4-6 )  |
| Immunity to electromagnetic disturbances | 2-150 kHz for kWh-meters   |
| Radio frequency emission                 | EN 55022, class B (CISPR22)  |
| Electrostatic discharge                  | 15 kV ( IEC 61000-4-2 )  |
| <b>Standards</b>                         | IEC 62052-11, IEC 62053-21 class 1 & 2, IEC 62053-23 class 2, IEC 62054-21, GB/T 17215.211-2006, GBT 17215.321-2008 class 1 & 2, GB 4208-2008, EN 50470-1, EN 50470-3 category A & B |

**Specifications for A42 transformer connected meters**

|                                    |  |
|------------------------------------|--|
| <b>Voltage inputs</b>              |  |
| Nominal voltage                    | 230 V AC                               |
| Voltage range                      | 57.7 - 288 V AC (-20% - + 15%)         |
| Power dissipation voltage circuits | 0.8 VA (0.8 W) at 230 V AC             |
| Power dissipation current circuits | 0.001 VA (0.001 W) at I <sub>ref</sub> |
| Terminal wire area                 | 0.5 - 10 mm <sup>2</sup>               |
| Recommended tightening torque      | 1.5 Nm                                 |
| <b>Current inputs</b>              |  |

## Technical data

|                                   |   |
|-----------------------------------|---|
| Rated current $I_n$               | 1 A   |
| Reference current $I_{ref}$       | 1 A   |
| Maximum current $I_{max}$         | 6 A   |
| Transitional current $I_{tr}$     | 0.05 A  |
| Minimum current $I_{min}$         | 0.01 A  |
| Starting current $I_{st}$         | < 1 mA  |
| Terminal wire area                | 0.5 - 10mm <sup>2</sup>   |
| Recommended tightening torque     | 1.5 Nm  |
| <b>General data</b>               |   |
| Frequency                         | 50 or 60 Hz ± 5%  |
| Accuracy                          | 0.5%, 1%  |
| Accuracy of internal clock        | 5 ppm at reference temperature 25°C   |
| Display                           | 96x64 pixels, view area 39x26 mm  |
| <b>Mechanical</b>                 |   |
| Material                          | Polycarbonate in transparent front glass, bottom case, upper case and terminal cover. Glass reinforced polycarbonate in terminal block. |
| Weight                            | 0.20 kg   |
| <b>Environmental</b>              |   |
| Operating temperature             | -40°C - +70°C   |
| Storage temperature               | -40°C - +85°C   |
| Humidity                          | 75% yearly average, 95% on 30 days/year   |
| Resistance to fire and heat       | Terminal 960°C, cover 650°C (IEC 60695-2-1)   |
| Resistance to water and dust      | IP 20 on terminal block without protective enclosure and IP 51 in protective enclosure, according to IEC 60529.                         |
| Mechanical environment            | Class M2 in accordance with the Measuring Instrument Directive (MID), (2014/32/UE).   |
| Electromagnetic environment       | Class E2 in accordance with the Measuring Instrument Directive (MID), (2014/32/UE).   |
| <b>Outputs</b>                    |   |
| Current                           | 2 - 100 mA  |
| Voltage                           | 5-240 V AC/DC. For meters with only 1 output, 5 - 40 V DC.  |
| Pulse output frequency            | Prog. 1 - 9999 imp/MWh, 1 - 9999 imp/kWh, 1 - 9999 imp/Wh   |
| Pulse length                      | 10 - 990 ms   |
| Terminal wire area                | 0.5 - 1 mm <sup>2</sup>   |
| Recommended tightening torque     | 0.25 Nm   |
| <b>Inputs</b>                     |   |
| Voltage                           | 0-240 V AC/DC   |
| Off                               | 0-5 V AC/DC   |
| ON                                | 57-240 V AC, 24-240 V DC  |
| Min. pulse length and pulse pause | 30 ms   |
| Terminal wire area                | 0.5 - 1 mm <sup>2</sup>   |
| Recommended tightening torque     | 0.25 Nm   |

|  |  |
|--|--|
| <b>Communication</b>                     |  |
| Terminal wire area                       | 0.5 - 1 mm   |
| Recommended tightening torque            | 0.25 Nm  |
| M-Bus                                    | EN 13757-2, EN 13757-3   |
| Modbus                                   | Modbus Application Protocol Specification V1.1b  |
| EQ-Bus                                   | IEC 62056-42, 62056-46, 62056-53, 62056-61, 62056-62   |
| <b>Transformer ratios</b>                |  |
| Configurable voltage ratio (VT)          | 1 - 9999   |
| Configurable current ratio (CT)          | 1 - 9999   |
| Max total transformer ratio (VT*CT)      | 999999   |
| <b>Pulse indicator (LED)</b>             |  |
| Pulse Frequency                          | 5000 imp/kWh   |
| Pulse length                             | 40 ms  |
| <b>EMC compatibility</b>                 |  |
| Impulse voltage test                     | 6 kV 1.2/50µs (IEC 60060-1)  |
| Surge voltage test                       | 4 kV 1.2/50µs (IEC 61000-4-5)  |
| Fast transient burst test                | 4 kV (IEC 61000-4-4)   |
| Immunity to electromagnetic HF-fields    | 80 MHz - 2 GHz at 10 V/m (IEC61000-4-3)  |
| Immunity to conducted disturbance        | 150kHz – 80MHz, ( IEC 61000-4-6 )  |
| Immunity to electromagnetic disturbances | 2-150 kHz for kWh-meters   |
| Radio frequency emission                 | EN 55022, class B (CISPR22)  |
| Electrostatic discharge                  | 15 kV (IEC 61000-4-2)  |
| <b>Standards</b>                         | IEC 62052-11, IEC 62053-21 class 1 & 2, IEC 62053-23 class 2, IEC 62054-21, GB/T 17215.211-2006, GBT 17215.321-2008 class 1 & 2, GB 4208-2008, EN 50470-1, EN 50470-3 category A & B |

6.2 Physical dimensions

A41/A42

The following drawing shows the physical dimensions of the A41 and the A42 meters.

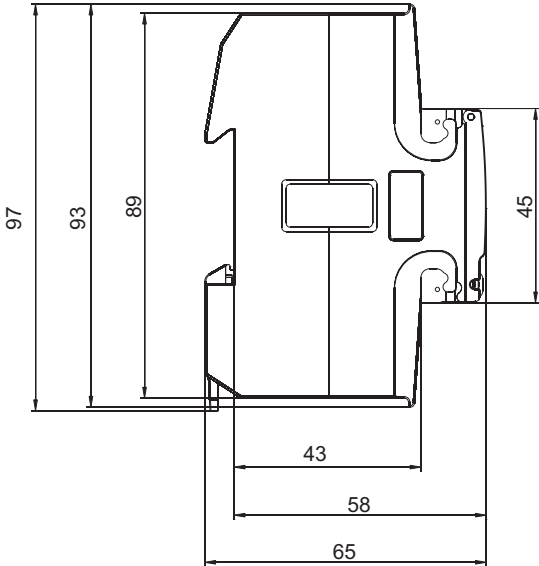
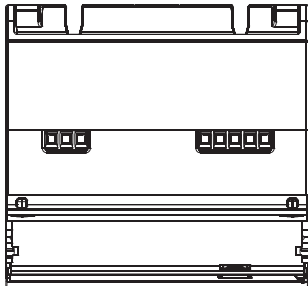
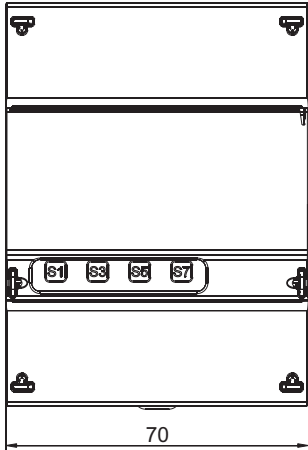
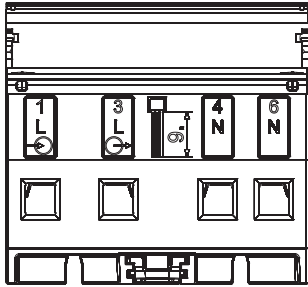



## Chapter 7: Measurement Methods

---

### Overview

This chapter contains information about measurement theory and the most commonly used measurement methods. The information can be used to better understand the meter behavior and/or to pick the correct measurement method.

---

### In this chapter

The following topics are covered in this chapter:

|  |    |
|--|----|
| 7.1 Measuring Energy .....                   | 74 |
| 7.1.1 Single Phase, 1-Element Metering ..... | 76 |

### 7.1 Measuring Energy

---

#### Active energy

It is easy to understand the need for a utility to measure active energy, since the information is necessary to bill the customer correctly. Usually the more energy the customer consumes the higher the accuracy of the meter needs to be. Normally 4 accuracy classes are used: 2%- (small consumers, e.g. households), 1%-, 0.5%- and 0.2%-meters with defined power levels for each class.

Also from a customer point of view it is easy to understand the need to measure the active energy as it can give him information about where and when energy is consumed. This information can then be used to take measures to decrease the consumption.

In many cases it is desired to simplify the measurement. In such cases simplified methods can be used of which the most common are described in this chapter. These methods most often require a balanced load, which means that the impedance is the same in all phases giving the same current amplitude and power factor in all phases.

---

#### Reactive energy

Sometimes there is also a need to measure the reactive energy. Consumer equipment often introduces a phase shift between current and voltage due to the fact that the load has a more or less reactive component, e.g. motors that have an inductive component, etc. A reactive load will increase the current which means that the power source generator and the size of the power lines have to increase which in turn means higher cost for the utility. A higher current also means that the line losses increase.

Because of that, the maximum permissible phase shift is sometimes governed in the terms of the contract that the consumer have with the power supplier. If the consumer exceeds a specified maximum reactive load, he will be liable for an extra charge. This type of contract will require a utility meter that measures reactive energy and/or power.

Also, from the customer's point of view, it may be of some interest to measure reactive energy/power since it gives him knowledge about the nature of the load. That is, how big the different loads are and how they vary over time. This knowledge can be used in the planning how to decrease the reactive power/energy to decrease the electricity bill.

---

#### Resistive, inductive and capacitive loads

Resistive loads don't give rise to any phase shifts. Inductive loads have phase shift in one direction with the current lagging the voltage, while capacitive loads produces a phase shift in the opposite direction with the current leading the voltage. As a result, inductive and capacitive loads can be used to compensate each other

**Illustration**

The following illustration shows a vector diagram for resistive, inductive and capacitive loads:

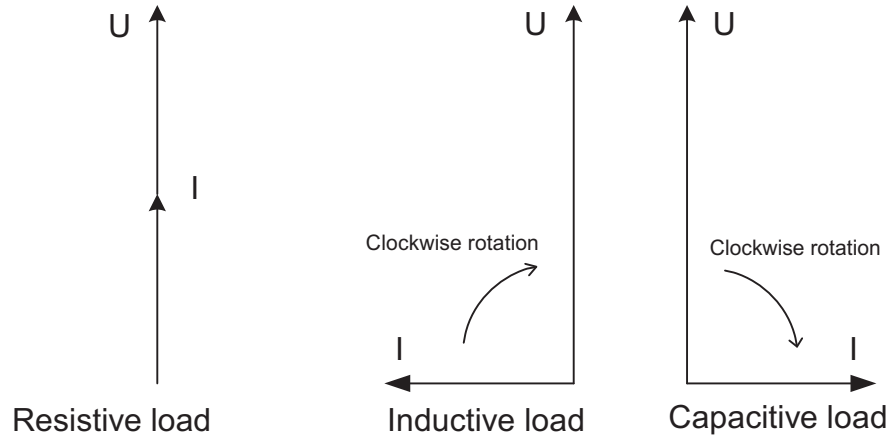

**Phase displacement**

A load that consumes both reactive and active energy can be divided into active and reactive components. The angle between the apparent power ( $U \cdot I$ ) vector and the active power component is described as phase displacement angle or power factor angle, often referred to as  $\phi$ .  $\cos \phi$  is referred to as the power factor.

**Illustration**

The following illustration shows a vector diagram for a load with an active and a reactive component:

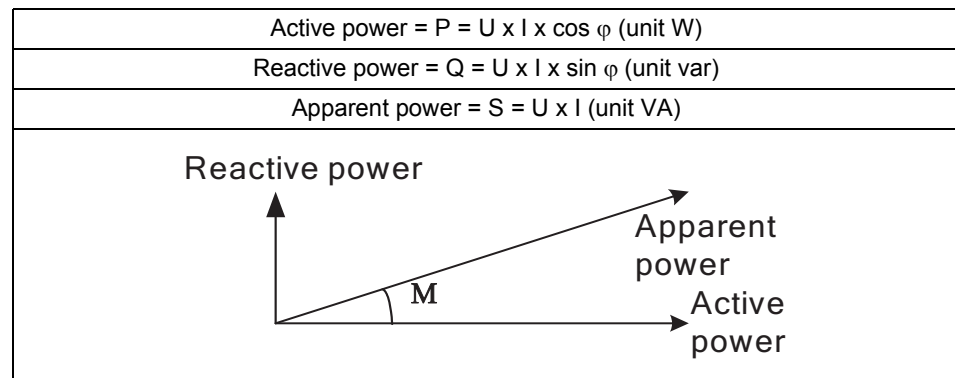

**The 4 power quadrants**

The type of load can be represented geometrically by four quadrants. In the first quadrant the load is inductive and active and energy is imported (energy is delivered from the utility to the customer). In the second quadrant the load is capacitive and active energy is exported and reactive energy is imported. In the third quadrant the load is inductive and active and reactive energy is exported. In the last quadrant the load is capacitive and active energy is imported and reactive energy exported.

## Illustration

The following illustration shows the loads

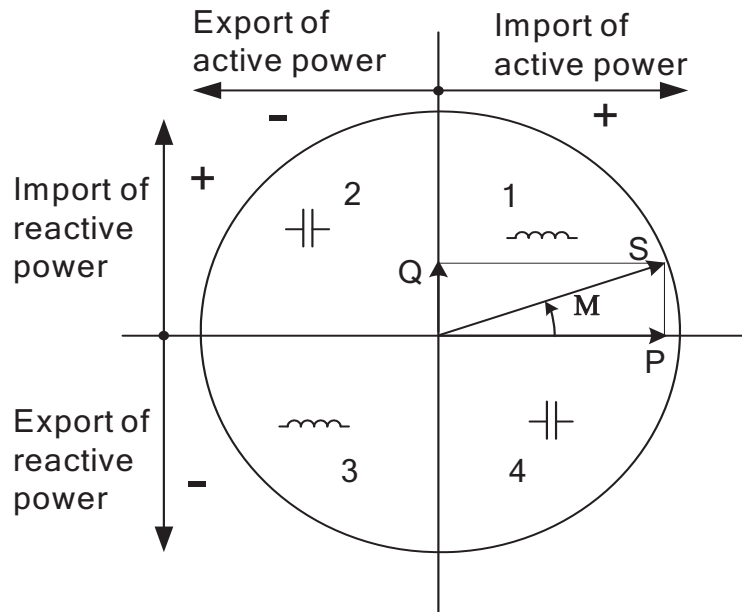

---

## 7.1.1 Single Phase, 1-Element Metering

### 1- element metering in a 2-wire system

In a 2-wire installation a single phase meter is used. Normally the 2 wires are a phase voltage and the neutral.

The active energy consumed by the load is the product of momentary voltage and current integrated over the desired measuring time period.

### Calculating active power

In the case where no harmonics is present and the rms value of the voltage and current is constant, the active power can be expressed as:

$$P = U_{\text{rms}} * I_{\text{rms}} * \cos \varphi$$

where  $\varphi$  is the phase angle between the voltage and the current.

**Illustration**

The following illustration shows a direct connected single phase meter measuring the active energy (E) consumed by a load.

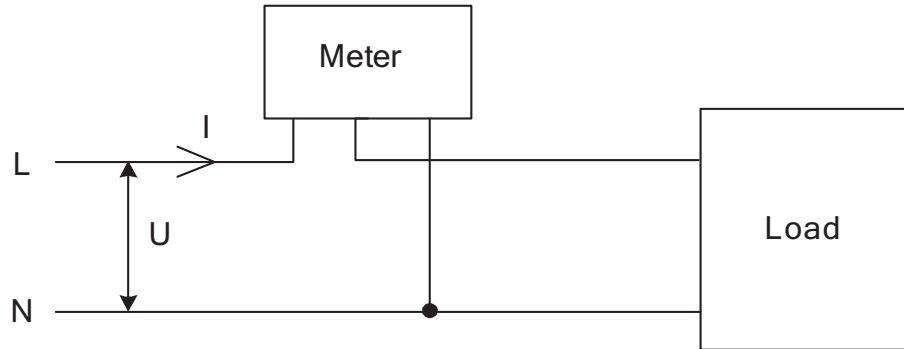

**1-element metering in a 4-wire system**

In 4-wire system the single element metering method only gives correct results in a balanced system (same voltage, current and power factor in all phases). This method should not be used for accurate measurement, but can be used when high accuracy is not needed.

**Illustration**

The following illustration shows single phase metering in a 3-phase system.

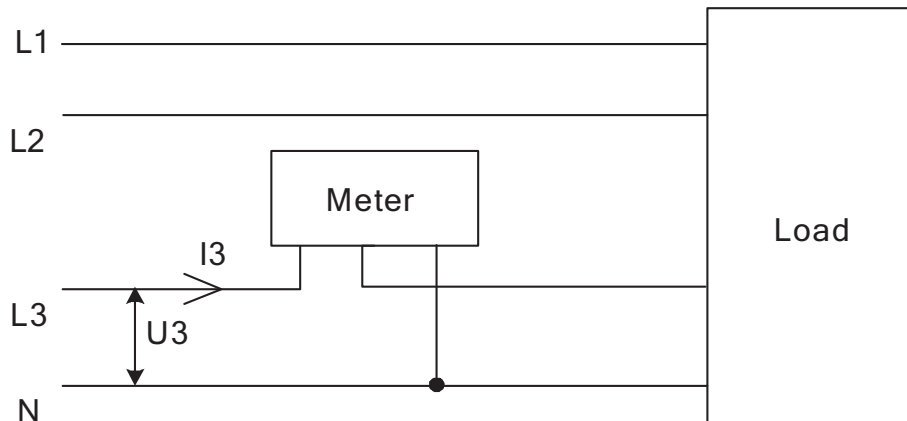

**Measurement Methods**

---

**Summation metering**

The currents from several different transformers can be summed into one single meter.

---

**Illustration**

The following illustration shows summation metering in a single phase meter:

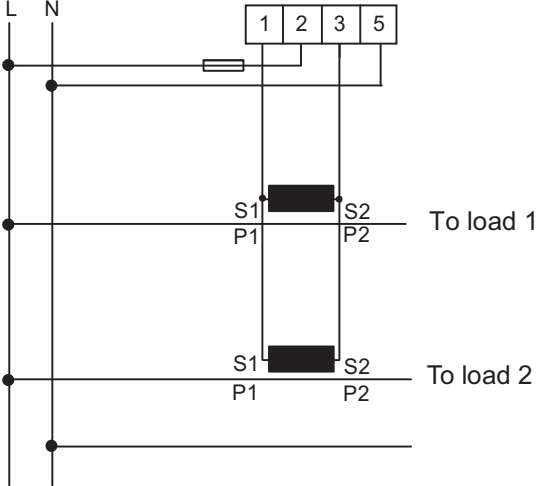

## Chapter 8: Service & Maintenance

---

### Overview

This chapter contains information about service and maintenance of the product.

---

---

### In this chapter

The following topics are covered in this chapter:

8.1 Service and Maintenance ..... 80

**8.1 Service and Maintenance**

---

**Service** This product contains no parts that can be repaired or exchanged. A broken meter must be replaced.

---

**Cleaning** If the meter needs to be cleaned, use a lightly moistened cloth with a mild detergent to wipe it.

**!** **Caution – Be careful that no liquid gets into the meter since it can ruin the equipment.**

---



## Chapter 9: Communication with Modbus

---

### Overview

This chapter describes the mapping from meter data to Modbus and how to read and write to registers. The chapter contains information for all functionality and data for the complete A series family. For single phase meters some data does not exist, for example data for phase 2 and 3.

---

### In this chapter

The following topics are covered in this chapter:

|        |   |     |
|--------|---|-----|
| 9.1    | Bus Description .....                             | 82  |
| 9.2    | About the Modbus Protocol .....                   | 83  |
| 9.2.1  | Function Code 3 (Read holding registers) .....    | 83  |
| 9.2.2  | Function Code 16 (Write multiple registers) ..... | 85  |
| 9.2.3  | Function Code 6 (Write single register) .....     | 86  |
| 9.3    | Reading and Writing to Registers .....            | 88  |
| 9.4    | Mapping Tables .....                              | 89  |
| 9.5    | Historical Data .....                             | 100 |
| 9.5.1  | Quantity identifiers .....                        | 103 |
| 9.6    | Previous Values .....                             | 108 |
| 9.6.1  | Reading Previous Values .....                     | 110 |
| 9.7    | Demand .....                                      | 112 |
| 9.7.1  | Reading Demand .....                              | 114 |
| 9.8    | Event logs .....                                  | 116 |
| 9.8.1  | Reading Event logs .....                          | 118 |
| 9.9    | Load profile .....                                | 119 |
| 9.9.1  | Reading Load profile .....                        | 121 |
| 9.10   | Configuration .....                               | 122 |
| 9.10.1 | Previous values .....                             | 122 |

9.1 Bus Description

**General** Modbus communication in the A series meters is done on a 3-wire (A, B and Common) polarity dependent bus according to the RS-485 standard. Maximum number of meters connected to one physical bus is 247 (which is the same as the individual device address range in Modbus).

---

**Topology** The RS-485 bus uses line topology, see figure below. Stubs at the meter connections are allowed but should be kept as short as possible and no longer than 1 m. Bus termination in both ends of the line should be used. The resistors should have the same values as the characteristic impedance of the cable which normally is 120 ohm.

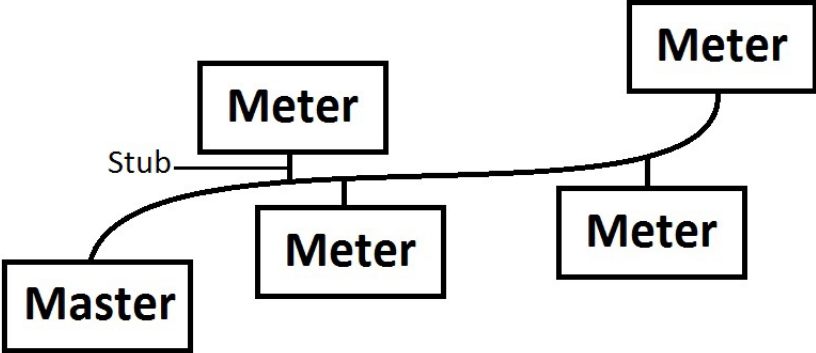

Line Topology

**Cable** Cable used is non shielded or shielded twisted pair cable with wire area of 0.35-1.5 mm<sup>2</sup>. If shielded cable is used the shield should be connected to ground in one end. Maximum length of the bus is 700 m.

---

## 9.2 About the Modbus Protocol

### General

Modbus is a master-slave communication protocol that can support up to 247 slaves organized as a multidrop bus. The communication is half duplex. Services on Modbus are specified by function codes.

The function codes are used to read or write 16 bit registers. All metering data, such as active energy, voltage or firmware version, is represented by one or more such registers. For further information about the relation between register number and metering data, refer to “Mapping Tables” on page - 89.

The Modbus protocol is specified in its entirety in Modbus Application Protocol Specification V1.1b. The document is available at <http://www.modbus.org>

### Supported function codes

The following function codes are supported:

- Function code 3 (Read holding registers)
- Function code 6 (Write single register)
- Function code 16 (Write multiple registers)

### Modbus request frame

A Modbus request frame generally has the following structure:

|               |               |      |             |
|---------------|---------------|------|-------------|
| Slave Address | Function Code | Data | Error Check |
|---------------|---------------|------|-------------|

|               |  |
|---------------|--|
| Slave address | Modbus slave address, 1 byte.                      |
| Function code | Decides the service to be performed.               |
| Data          | Dependent on the function code. The length varies. |
| Error check   | CRC, 2 bytes                                       |

### Message types

The network messages can be query-response or broadcast type. The query-response command sends a query from the master to an individual slave and is generally followed by a response.

The broadcast command sends a message to all slaves and is never followed by a response. Broadcast is supported by function code 6 and 16.

### 9.2.1 Function Code 3 (Read holding registers)

#### General

Function code 3 is used to read measurement values or other information from the electricity meter. It is possible to read up to 125 consecutive registers at a time. This means that multiple values can be read in one request.

### Request frame

A request frame has the following structure:

|               |               |         |                  |             |
|---------------|---------------|---------|------------------|-------------|
| Slave Address | Function Code | Address | No. of Registers | Error Check |
|---------------|---------------|---------|------------------|-------------|

### Example of a request

The following is an example of a request. (read total energy import, etc...)

|                              |      |
|------------------------------|------|
| Slave address                | 0x01 |
| Function code                | 0x03 |
| Start address, high byte     | 0x50 |
| Start address, low byte      | 0x00 |
| No. of registers, high byte  | 0x00 |
| No. of registers, low byte   | 0x18 |
| Error check (CRC), high byte | 0x54 |
| Error check (CRC), low byte  | 0xC0 |

### Response frame

A response frame has the following structure:

|               |               |            |                 |             |
|---------------|---------------|------------|-----------------|-------------|
| Slave Address | Function Code | Byte Count | Register Values | Error Check |
|---------------|---------------|------------|-----------------|-------------|

### Example of a response

The following is an example of a response:

|                                     |      |
|-------------------------------------|------|
| Slave address                       | 0x01 |
| Function code                       | 0x03 |
| Byte count                          | 0x30 |
| Value of register 0x5000, high byte | 0x00 |
| Value of register 0x5000, low byte  | 0x15 |
| ...                                 |      |
| Value of register 0x5017, high byte | 0xFF |
| Value of register 0x5017, low byte  | 0xFF |
| Error check (CRC), high byte        | 0xFF |
| Error check (CRC), low byte         | 0xFF |

In this example, the slave with the Modbus address 1 responds to a read request. The number of data bytes is 0x30. The first register (0x5000) has the value 0x0015 and the last (0x5017) has the value 0xFFFF

---

### 9.2.2 Function Code 16 (Write multiple registers)

**General**

Function code 16 is used to modify settings in the meter, such as date/time, to control output and to reset values, such as power fail counter. It is possible to write up to 123 consecutive registers in a single request. This means that several settings can be modified and/or several reset operations can be performed in a single request.

**Request frame**

A request frame has the following structure:

| Slave Address | Function Code | Start Address | No. of Registers | Byte Count | Register Values | Error Check |
|---------------|---------------|---------------|------------------|------------|-----------------|-------------|
|---------------|---------------|---------------|------------------|------------|-----------------|-------------|

**Example of a request**

The following is an example of a request (set Date/Time to November 11, 2010, 12:13:14):

|                                     |      |
|-------------------------------------|------|
| Slave address                       | 0x01 |
| Function code                       | 0x10 |
| Start address, high byte            | 0x8A |
| Start address, low byte             | 0x00 |
| No. of registers, high byte         | 0x00 |
| No. of registers, low byte          | 0x03 |
| Byte count                          | 0x06 |
| Value of register 0x8A00, high byte | 0x0A |
| Value of register 0x8A00, low byte  | 0x0B |
| Value of register 0x8A01, high byte | 0x0B |
| Value of register 0x8A01, low byte  | 0x0C |
| Value of register 0x8A02, high byte | 0x0D |
| Value of register 0x8A02, low byte  | 0x0E |
| Error check (CRC), high byte        | 0x8C |
| Error check (CRC), low byte         | 0x82 |

In this example the master sends a write request to the slave that has the Modbus address 1. The first register to write is 0x8A00 and the number of registers to write is 0x03. This means that the registers 0x8A00 to 0x8A02 are written. Register 0x8A00 is set to the value 0x0A0B, and so on.

### Response frame

A response frame has the following structure:

|               |               |               |                  |             |
|---------------|---------------|---------------|------------------|-------------|
| Slave Address | Function Code | Start Address | No. of Registers | Error Check |
|---------------|---------------|---------------|------------------|-------------|

### Example of a response

The following is an example of a response:

|                              |      |
|------------------------------|------|
| Slave address                | 0x01 |
| Function code                | 0x10 |
| Register address, high byte  | 0x8A |
| Register address, low byte   | 0x00 |
| No. of registers, high byte  | 0x00 |
| No. of registers, low byte   | 0x03 |
| Error check (CRC), high byte | 0xAA |
| Error check (CRC), low byte  | 0x10 |

In the example above the slave with the Modbus address 1 responds to a write request. The first register is 0x8A00 and 0x03 registers have been successfully written to.

## 9.2.3 Function Code 6 (Write single register)

---

### General

Function code 6 can be used as an alternative to function code 16 if there is only one register to be written. It can, for example be used to reset the power fail counter.

### Request frame

A request frame has the following structure:

|               |               |                  |                |             |
|---------------|---------------|------------------|----------------|-------------|
| Slave Address | Function Code | Register Address | Register Value | Error Check |
|---------------|---------------|------------------|----------------|-------------|

### Example of a request

The following is an example of a request (reset power fail counter):

|                             |      |
|-----------------------------|------|
| Slave address               | 0x01 |
| Function code               | 0x06 |
| Register address, high byte | 0x8F |
| Register address, low byte  | 0x00 |
| No. of registers, high byte | 0x00 |
| No. of registers, low byte  | 0x01 |

|                              |      |
|------------------------------|------|
| Error check (CRC), high byte | 0x62 |
| Error check (CRC), low byte  | 0xDE |

---

**Response frame** Using function code 6, the response frame is an echo of the request frame.

---

**9.2.3.1 Exception Responses**

---

**General** If an error should occur while processing a request, the meter gives an exception response that contains an exception code.

---

**Exception frame** An exception frame has the following structure:

|               |               |                |             |
|---------------|---------------|----------------|-------------|
| Slave Address | Function Code | Exception Code | Error Check |
|---------------|---------------|----------------|-------------|

In the exception response the function code is set to the function code of the request plus 0x80.

---

**Exception codes** The exception codes that are used are listed in the following table:

| Exception code | Exception            | Definition   |
|----------------|----------------------|--|
| 01             | Illegal function     | A function code that is not supported has been used.               |
| 02             | Illegal data address | The requested register is outside the allowed range.               |
| 03             | Illegal data value   | The structure of a received message is incorrect.                  |
| 04             | Slave device failure | Processing the request fail due to an internal error in the meter. |

---

### 9.3 Reading and Writing to Registers

---

**Readable registers**

The readable range in the modbus mapping are registers 1000-8EFF (hexadecimal). Reading any registers within this range will result in a normal Modbus response. It is possible to read any number of registers between 1 and 125, i.e., it is not necessary to read all registers of a quantity listed on one line in the mapping tables. Any attempt to read outside this range will result in an illegal data address exception (Modbus exception code 2).

---

**Multi-register values**

For quantities that are represented as more than 1 register, the most significant byte is found in the high byte of the first (lowest) register. The least significant byte is found in the low byte of the last (highest) register.

---

**Unused registers**

Unused registers within the mapping range, for example missing quantities in the connected meter, will result in a normal Modbus response but the value of the register will be set to “invalid”.

For quantities with data type “unsigned”, the value will be FFFF in all registers. For quantities with data type “signed”, the value is the highest value possible to express. That means that a quantity that is represented by only one register will have the value 7FFF. A quantity that is represented by 2 registers will have the value 7FFFFFFF, and so on.

---

**Writing to registers**

Writing to registers is only permitted to the registers listed as writable in the mapping tables. Attempting to write to a register that is listed as writable but that is not supported by the meter will not result in an error indication.



**Note** – It is not possible to modify parts of a setting, e.g. to set only the year and month of the Date/time setting.

---

**Confirm set values**

After you set a value in the meter, it is recommended that you read the value to confirm the result, since it is not possible to confirm if a write was successful from the Modbus response.

---



## 9.4 Mapping Tables

### Introduction

The purpose of this section is to explain the relation between register number and metering data.

### Contents of the mapping tables

The following table explains the content of the mapping tables:

|                 |  |
|-----------------|--|
| Quantity        | Name of the meter quantity or other information available in the meter.                        |
| Details         | Refinement of the Quantity column.   |
| Start Reg (Hex) | Hexadecimal number for the first (lowest) Modbus Register for this quantity. *                 |
| Size            | Number of Modbus registers for the meter Quantity. A Modbus Register is 16 bits long.          |
| Res.            | Resolution of the value for this Quantity (if applicable).                                     |
| Unit            | Unit for the Quantity (if applicable).   |
| Data type       | Data type for this Quantity, i.e. how the value in the Modbus registers should be interpreted. |

\*It is expressed exactly as it is sent on the bus. That is, it should not be subtracted by 40 000 or decremented by 1, as is common for Modbus products.

### Total energy accumulators

All registers in the following table are read only:

| Quantity               | Details | Start reg (Hex) | Size | Res.  | Unit     | Data type |
|------------------------|---------|-----------------|------|-------|----------|-----------|
| Active import          | kWh     | 5000            | 4    | 0,01  | kWh      | Unsigned  |
| Active export          | kWh     | 5004            | 4    | 0,01  | kWh      | Unsigned  |
| Active net             | kWh     | 5008            | 4    | 0,01  | kWh      | Signed    |
| Reactive import        | kvarh   | 500C            | 4    | 0,01  | kvarh    | Unsigned  |
| Reactive export        | kvarh   | 5010            | 4    | 0,01  | kvarh    | Unsigned  |
| Reactive net           | kvarh   | 5014            | 4    | 0,01  | kvarh    | Signed    |
| Apparent import        | kVAh    | 5018            | 4    | 0,01  | kVAh     | Unsigned  |
| Apparent export        | kVAh    | 501C            | 4    | 0,01  | kVAh     | Unsigned  |
| Apparent net           | kVAh    | 5020            | 4    | 0,01  | kVAh     | Signed    |
| Active import CO2      | kVAh    | 5024            | 4    | 0,001 | kg       | Unsigned  |
| Active import Currency | kVAh    | 5034            | 4    | 0,001 | currency | Unsigned  |

### Energy accumulators divided into tariffs

All registers in the following table are read only:

| Quantity        | Details  | Start reg (Hex) | Size | Res. | Unit  | Data type |
|-----------------|----------|-----------------|------|------|-------|-----------|
| Active import   | Tariff 1 | 5170            | 4    | 0,01 | kWh   | Unsigned  |
| Active import   | Tariff 2 | 5174            | 4    | 0,01 | kWh   | Unsigned  |
| Active import   | Tariff 3 | 5178            | 4    | 0,01 | kWh   | Unsigned  |
| Active import   | Tariff 4 | 517C            | 4    | 0,01 | kWh   | Unsigned  |
| Active export   | Tariff 1 | 5190            | 4    | 0,01 | kWh   | Unsigned  |
| Active export   | Tariff 2 | 5194            | 4    | 0,01 | kWh   | Unsigned  |
| Active export   | Tariff 3 | 5198            | 4    | 0,01 | kWh   | Unsigned  |
| Active export   | Tariff 4 | 519C            | 4    | 0,01 | kWh   | Unsigned  |
| Reactive import | Tariff 1 | 51B0            | 4    | 0,01 | kvarh | Unsigned  |
| Reactive import | Tariff 2 | 51B4            | 4    | 0,01 | kvarh | Unsigned  |
| Reactive import | Tariff 3 | 51B8            | 4    | 0,01 | kvarh | Unsigned  |
| Reactive import | Tariff 4 | 51BC            | 4    | 0,01 | kvarh | Unsigned  |
| Reactive export | Tariff 1 | 51D0            | 4    | 0,01 | kvarh | Unsigned  |
| Reactive export | Tariff 2 | 51D4            | 4    | 0,01 | kvarh | Unsigned  |
| Reactive export | Tariff 3 | 51D8            | 4    | 0,01 | kvarh | Unsigned  |
| Reactive export | Tariff 4 | 51DC            | 4    | 0,01 | kvarh | Unsigned  |

### Energy accumulators per phase

All registers in the following table are read only:

| Quantity      | Details | Start reg (Hex) | Size | Res. | Unit | Data type |
|---------------|---------|-----------------|------|------|------|-----------|
| Active import | L1      | 5460            | 4    | 0,01 | kWh  | Unsigned  |
| Active import | L2      | 5464            | 4    | 0,01 | kWh  | Unsigned  |
| Active import | L3      | 5468            | 4    | 0,01 | kWh  | Unsigned  |
| Active export | L1      | 546C            | 4    | 0,01 | kWh  | Unsigned  |
| Active export | L2      | 5470            | 4    | 0,01 | kWh  | Unsigned  |
| Active export | L3      | 5474            | 4    | 0,01 | kWh  | Unsigned  |
| Active net    | L1      | 5478            | 4    | 0,01 | kWh  | Signed    |
| Active net    | L2      | 547C            | 4    | 0,01 | kWh  | Signed    |
| Active net    | L3      | 5480            | 4    | 0,01 | kWh  | Signed    |

| Quantity        | Details | Start reg (Hex) | Size | Res. | Unit  | Data type |
|-----------------|---------|-----------------|------|------|-------|-----------|
| Reactive import | L1      | 5484            | 4    | 0,01 | kvarh | Unsigned  |
| Reactive import | L2      | 5488            | 4    | 0,01 | kvarh | Unsigned  |
| Reactive import | L3      | 548C            | 4    | 0,01 | kvarh | Unsigned  |
| Reactive export | L1      | 5490            | 4    | 0,01 | kvarh | Unsigned  |
| Reactive export | L2      | 5494            | 4    | 0,01 | kvarh | Unsigned  |
| Reactive export | L3      | 5498            | 4    | 0,01 | kvarh | Unsigned  |
| Reactive net    | L1      | 549C            | 4    | 0,01 | kvarh | Signed    |
| Reactive net    | L2      | 54A0            | 4    | 0,01 | kvarh | Signed    |
| Reactive net    | L3      | 54A4            | 4    | 0,01 | kvarh | Signed    |
| Apparent import | L1      | 54A8            | 4    | 0,01 | kVAh  | Unsigned  |
| Apparent import | L2      | 54AC            | 4    | 0,01 | kVAh  | Unsigned  |
| Apparent import | L3      | 54B0            | 4    | 0,01 | kVAh  | Unsigned  |
| Apparent export | L1      | 54B4            | 4    | 0,01 | kVAh  | Unsigned  |
| Apparent export | L2      | 54B8            | 4    | 0,01 | kVAh  | Unsigned  |
| Apparent export | L3      | 54BC            | 4    | 0,01 | kVAh  | Unsigned  |
| Apparent net    | L1      | 54C0            | 4    | 0,01 | kVAh  | Signed    |
| Apparent net    | L2      | 54C4            | 4    | 0,01 | kVAh  | Signed    |
| Apparent net    | L3      | 54C8            | 4    | 0,01 | kVAh  | Signed    |

### Resettable energy accumulators

All registers in the following table are read only:

| Quantity                   | Start reg (Hex) | Size | Res. | Unit | Data type |
|----------------------------|-----------------|------|------|------|-----------|
| Resettable active import   | 552C            | 4    | 0,01 | kWh  | Unsigned  |
| Resettable active export   | 5530            | 4    | 0,01 | kWh  | Unsigned  |
| Resettable reactive import | 5534            | 4    | 0,01 | kWh  | Unsigned  |
| Resettable reactive export | 5538            | 4    | 0,01 | kWh  | Unsigned  |

### Instantaneous values

All registers in the following table are read only:

| Quantity            | Details | Start reg (Hex) | Size | Res.  | Unit | Value range   | Data type |
|---------------------|---------|-----------------|------|-------|------|---------------|-----------|
| Voltage             | L1-N    | 5B00            | 2    | 0,1   | V    |               | Unsigned  |
| Voltage             | L2-N    | 5B02            | 2    | 0,1   | V    |               | Unsigned  |
| Voltage             | L3-N    | 5B04            | 2    | 0,1   | V    |               | Unsigned  |
| Voltage             | L1-L2   | 5B06            | 2    | 0,1   | V    |               | Unsigned  |
| Voltage             | L3-L2   | 5B08            | 2    | 0,1   | V    |               | Unsigned  |
| Voltage             | L1-L3   | 5B0A            | 2    | 0,1   | V    |               | Unsigned  |
| Current             | L1      | 5B0C            | 2    | 0,01  | A    |               | Unsigned  |
| Current             | L2      | 5B0E            | 2    | 0,01  | A    |               | Unsigned  |
| Current             | L3      | 5B10            | 2    | 0,01  | A    |               | Unsigned  |
| Current             | N       | 5B12            | 2    | 0,01  | A    |               | Unsigned  |
| Active power        | Total   | 5B14            | 2    | 0,01  | W    |               | Signed    |
| Active power        | L1      | 5B16            | 2    | 0,01  | W    |               | Signed    |
| Active power        | L2      | 5B18            | 2    | 0,01  | W    |               | Signed    |
| Active power        | L3      | 5B1A            | 2    | 0,01  | W    |               | Signed    |
| Reactive power      | Total   | 5B1C            | 2    | 0,01  | var  |               | Signed    |
| Reactive power      | L1      | 5B1E            | 2    | 0,01  | var  |               | Signed    |
| Reactive power      | L2      | 5B20            | 2    | 0,01  | var  |               | Signed    |
| Reactive power      | L3      | 5B22            | 2    | 0,01  | var  |               | Signed    |
| Apparent power      | Total   | 5B24            | 2    | 0,01  | VA   |               | Signed    |
| Apparent power      | L1      | 5B26            | 2    | 0,01  | VA   |               | Signed    |
| Apparent power      | L2      | 5B28            | 2    | 0,01  | VA   |               | Signed    |
| Apparent power      | L3      | 5B2A            | 2    | 0,01  | VA   |               | Signed    |
| Frequency           |         | 5B2C            | 1    | 0,01  | Hz   |               | Unsigned  |
| Phase angle power   | Total   | 5B2D            | 1    | 0,1   | °    | -180°-+180°   | Signed    |
| Phase angle power   | L1      | 5B2E            | 1    | 0,1   | °    | -180°-+180°   | Signed    |
| Phase angle power   | L2      | 5B2F            | 1    | 0,1   | °    | -180°-+180°   | Signed    |
| Phase angle power   | L3      | 5B30            | 1    | 0,1   | °    | -180°-+180°   | Signed    |
| Phase angle voltage | L1      | 5B31            | 1    | 0,1   | °    | -180°-+180°   | Signed    |
| Phase angle voltage | L2      | 5B32            | 1    | 0,1   | °    | -180°-+180°   | Signed    |
| Phase angle voltage | L3      | 5B33            | 1    | 0,1   | °    | -180°-+180°   | Signed    |
| Phase angle current | L1      | 5B37            | 1    | 0,1   | °    | -180°-+180°   | Signed    |
| Phase angle current | L2      | 5B38            | 1    | 0,1   | °    | -180°-+180°   | Signed    |
| Phase angle current | L3      | 5B39            | 1    | 0,1   | °    | -180°-+180°   | Signed    |
| Power factor        | Total   | 5B3A            | 1    | 0,001 | -    | -1,000-+1,000 | Signed    |
| Power factor        | L1      | 5B3B            | 1    | 0,001 | -    | -1,000-+1,000 | Signed    |
| Power factor        | L2      | 5B3C            | 1    | 0,001 | -    | -1,000-+1,000 | Signed    |

| Quantity         | Details | Start reg (Hex) | Size | Res.  | Unit | Value range   | Data type |
|------------------|---------|-----------------|------|-------|------|---------------|-----------|
| Power factor     | L3      | 5B3D            | 1    | 0,001 | -    | -1,000-+1,000 | Signed    |
| Current quadrant | Total   | 5B3E            | 1    |       | -    | 1-4           | Unsigned  |
| Current quadrant | L1      | 5B3F            | 1    |       | -    | 1-4           | Unsigned  |
| Current quadrant | L2      | 5B40            | 1    |       | -    | 1-4           | Unsigned  |
| Current quadrant | L3      | 5B41            | 1    |       | -    | 1-4           | Unsigned  |



**Note –** Powers are sent out as 32 bit signed integers, expressed in W (or var/VA) with 2 decimals. This means that the maximum power possible to express is approximately  $\pm 21$  MW. If the power is higher than that the user is advised to read power from the DMTME mapping instead, where the scaling is in W without decimals.

### Harmonics

Harmonics are mapped in one register each, starting with THD and then followed by 2nd, 3rd, 4th harmonic and so on.

All registers in the following table are read only:

| Quantity          | Details | Start reg (Hex) | Size/ harmonic | Nr of harmonics | Res. | Unit | Data type |
|-------------------|---------|-----------------|----------------|-----------------|------|------|-----------|
| Voltage harmonics | L1-N    | 5D00            | 1              | 16              | 0,1  | %    | Unsigned  |
| Voltage harmonics | L2-N    | 5D80            | 1              | 16              | 0,1  | %    | Unsigned  |
| Voltage harmonics | L3-N    | 5E00            | 1              | 16              | 0,1  | %    | Unsigned  |
| Voltage harmonics | L1-L2   | 5E80            | 1              | 16              | 0,1  | %    | Unsigned  |
| Voltage harmonics | L3-L2   | 5F00            | 1              | 16              | 0,1  | %    | Unsigned  |
| Voltage harmonics | L1-L3   | 5F80            | 1              | 16              | 0,1  | %    | Unsigned  |
| Current harmonics | L1      | 6000            | 1              | 16              | 0,1  | %    | Unsigned  |
| Current harmonics | L2      | 6080            | 1              | 16              | 0,1  | %    | Unsigned  |
| Current harmonics | L3      | 6100            | 1              | 16              | 0,1  | %    | Unsigned  |
| Current harmonics | N       | 6180            | 1              | 16              | 0,1  | %    | Unsigned  |

### Inputs and outputs

The following table contains both writable and read only registers:

| Quantity | Details | Start Reg (Hex) | Size | Possible values | Data type | Read/ Write |
|----------|---------|-----------------|------|-----------------|-----------|-------------|
| Output 1 |         | 6300            | 1    | ON=1, OFF=0     | Unsigned  | R/W         |

| Quantity | Details       | Start Reg (Hex) | Size | Possible values | Data type | Read/Write |
|----------|---------------|-----------------|------|-----------------|-----------|------------|
| Output 2 |               | 6301            | 1    | ON=1, OFF=0     | Unsigned  | R/W        |
| Output 3 |               | 6302            | 1    | ON=1, OFF=0     | Unsigned  | R/W        |
| Output 4 |               | 6303            | 1    | ON=1, OFF=0     | Unsigned  | R/W        |
| Input 1  | Current state | 6308            | 1    | ON=1, OFF=0     | Unsigned  | R          |
| Input 2  | Current state | 6309            | 1    | ON=1, OFF=0     | Unsigned  | R          |
| Input 3  | Current state | 630A            | 1    | ON=1, OFF=0     | Unsigned  | R          |
| Input 4  | Current state | 630B            | 1    | ON=1, OFF=0     | Unsigned  | R          |
| Input 1  | Stored state  | 6310            | 1    | ON=1, OFF=0     | Unsigned  | R          |
| Input 2  | Stored state  | 6311            | 1    | ON=1, OFF=0     | Unsigned  | R          |
| Input 3  | Stored state  | 6312            | 1    | ON=1, OFF=0     | Unsigned  | R          |
| Input 4  | Stored state  | 6313            | 1    | ON=1, OFF=0     | Unsigned  | R          |
| Input 1  | Counter       | 6318            | 4    |                 | Unsigned  | R          |
| Input 2  | Counter       | 631C            | 4    |                 | Unsigned  | R          |
| Input 3  | Counter       | 6320            | 4    |                 | Unsigned  | R          |
| Input 4  | Counter       | 6324            | 4    |                 | Unsigned  | R          |

### Production data and identification

All registers in the following table are read only:

| Quantity               | Start Reg (Hex) | Size | Data type  |
|------------------------|-----------------|------|--|
| Serial number          | 8900            | 2    | Unsigned   |
| Meter firmware version | 8908            | 8    | ASCII string (up to 16 characters)                       |
| Modbus mapping version | 8910            | 1    | 2 bytes  |
| Type designation       | 8960            | 6    | ASCII string (12 characters, including null termination) |

**Meter firmware version** is expressed as a string of 3 digits separated by periods, e.g. 1.0.0. Unused bytes at the end are set to binary 0.

In the **Modbus mapping version** register the high byte corresponds to the Major version (1-255), and the low byte corresponds to the Minor version (0-255).

**Miscellaneous**

In the following table Date/time and current tariff are writable. All other registers are read only:

| Quantity                                 | Start Reg (Hex) | Description   | Size | Data type  | Read/Write |
|--|-----------------|---|------|------------|------------|
| Date/time                                | 8A00            | Byte 0: year*<br>Byte 1: month<br>Byte 2: day<br>Byte 3: hour<br>Byte 4: minute<br>Byte 5: second | 3    | Date/Time  | R/W        |
| Day of week                              | 8A03            | Weekdays (1-7, Mo=1)  | 1    | Unsigned   | R          |
| DST active                               | 8A04            | 1=DST active<br>0=DST inactive  | 1    | Unsigned   | R          |
| Day type                                 | 8A05            | Value 0-15 correspond to day type 1-16  | 1    | Unsigned   | R          |
| Season                                   | 8A06            | Value 0-3 correspond to season 1-4  | 1    | Unsigned   | R          |
| Current tariff                           | 8A07            | Tariff 1-4  | 1    | Unsigned   | R/W        |
| Error flags                              | 8A13            | 64 flags  | 4    | Bit string | R          |
| Information flags                        | 8A19            | 64 flags  | 4    | Bit string | R          |
| Warning flags                            | 8A1F            | 64 flags  | 4    | Bit string | R          |
| Alarm flags                              | 8A25            | 64 flags  | 4    | Bit string | R          |
| Power fail counter                       | 8A2F            |   | 1    | Unsigned   | R          |
| Power outage time                        | 8A39            | Byte 0-2: days*<br>Byte 3: hours<br>Byte 4: minutes<br>Byte 5: seconds                            | 3    | Days/Time  | R          |
| Reset counter for active energy import   | 8A48            |   | 4    | Unsigned   | R          |
| Reset counter for active energy export   | 8A4C            |   | 4    | Unsigned   | R          |
| Reset counter for reactive energy import | 8A50            |   | 4    | Unsigned   | R          |
| Reset counter for reactive energy export | 8A54            |   | 4    | Unsigned   | R          |

\* Byte 0 is the highest byte of the lowest register

The **Reset counter** registers show the number of times the resettable energy accumulators have been reset.

### Settings

All registers in the following table have read and write access except number of elements which is read only:

| Quantity   | Start Reg (hex) | Size | Res.  | Unit         | Data type |
|--|-----------------|------|-------|--------------|-----------|
| Current transformer ratio primary current  | 8C04            | 2    |       | -            | Unsigned  |
| Voltage transformer ratio primary voltage  | 8C06            | 2    |       | -            | Unsigned  |
| Current transformer ratio secondary current  | 8C08            | 2    |       | -            | Unsigned  |
| Voltage transformer ratio secondary voltage  | 8C0A            | 2    |       | -            | Unsigned  |
| CO2 conversion factor  | 8CE0            | 2    | 0.001 | kg/kWh       | Unsigned  |
| Currency conversion factor   | 8CE2            | 2    | 0.01  | Currency/kWh | Unsigned  |
| LED source (0 = active energy, 1 = reactive energy)  | 8CE4            | 1    |       | -            | Unsigned  |
| Number of elements (values 1-3)  | 8CE5            | 1    |       | -            | Unsigned  |
| DST start (month in 8CE6 high byte, day of month in 8CE6 low byte, day of week in 8CE7 high byte, hour in 8CE7 low byte) | 8CE6            | 2    |       | -            | Unsigned  |
| DST end (month in 8CE6 high byte, day of month in 8CE6 low byte, day of week in 8CE7 high byte, hour in 8CE7 low byte)   | 8CE8            | 2    |       | -            | Unsigned  |
| DST enabled (0 = disabled, 1 = enabled)  | 8CEA            | 1    |       | -            | Unsigned  |



**Operations**

All registers in the following table are write only:

| Quantity                                | Details | Start Reg (hex) | Size | Action                               | Data type |
|---|---------|-----------------|------|--------------------------------------|-----------|
| Reset power fail counter                |         | 8F00            | 1    | Write the value 1 to perform a reset | Unsigned  |
| Reset power outage time                 |         | 8F05            | 1    | Write the value 1 to perform a reset | Unsigned  |
| Reset input counter                     | Input 1 | 8F0B            | 1    | Write the value 1 to perform a reset | Unsigned  |
| Reset input counter                     | Input 2 | 8F0C            | 1    | Write the value 1 to perform a reset | Unsigned  |
| Reset input counter                     | Input 3 | 8F0D            | 1    | Write the value 1 to perform a reset | Unsigned  |
| Reset input counter                     | Input 4 | 8F0E            | 1    | Write the value 1 to perform a reset | Unsigned  |
| Reset stored state                      | input 1 | 8F13            | 1    | Write the value 1 to perform a reset | Unsigned  |
| Reset stored state                      | Input 2 | 8F14            | 1    | Write the value 1 to perform a reset | Unsigned  |
| Reset stored state                      | input 3 | 8F15            | 1    | Write the value 1 to perform a reset | Unsigned  |
| Reset stored state                      | Input 4 | 8F16            | 1    | Write the value 1 to perform a reset | Unsigned  |
| Reset resettable active energy import   |         | 8F1B            | 1    | Write the value 1 to perform a reset | Unsigned  |
| Reset resettable active energy export   |         | 8F1C            | 1    | Write the value 1 to perform a reset | Unsigned  |
| Reset resettable reactive energy import |         | 8F1D            | 1    | Write the value 1 to perform a reset | Unsigned  |
| Reset resettable reactive energy export |         | 8F1E            | 1    | Write the value 1 to perform a reset | Unsigned  |
| Reset Previous values                   |         | 8F1F            | 1    | Write the value 1 to perform a reset | Unsigned  |
| Reset Demand                            |         | 8F20            | 1    | Write the value 1 to perform a reset | Unsigned  |
| Reset Load profile channel 1            |         | 8F21            | 1    | Write the value 1 to perform a reset | Unsigned  |
| Reset Load profile channel 2            |         | 8F22            | 1    | Write the value 1 to perform a reset | Unsigned  |

| Quantity                     | Details | Start Reg (hex) | Size | Action  | Data type |
|------------------------------|---------|-----------------|------|---|-----------|
| Reset Load profile channel 3 |         | 8F23            | 1    | Write the value 1 to perform a reset          | Unsigned  |
| Reset Load profile channel 4 |         | 8F24            | 1    | Write the value 1 to perform a reset          | Unsigned  |
| Reset Load profile channel 5 |         | 8F25            | 1    | Write the value 1 to perform a reset          | Unsigned  |
| Reset Load profile channel 6 |         | 8F26            | 1    | Write the value 1 to perform a reset          | Unsigned  |
| Reset Load profile channel 7 |         | 8F27            | 1    | Write the value 1 to perform a reset          | Unsigned  |
| Reset Load profile channel 8 |         | 8F28            | 1    | Write the value 1 to perform a reset          | Unsigned  |
| Reset System log             |         | 8F31            | 1    | Write the value 1 to perform a reset          | Unsigned  |
| Reset Event log              |         | 8F32            | 1    | Write the value 1 to perform a reset          | Unsigned  |
| Reset Net quality log        |         | 8F33            | 1    | Write the value 1 to perform a reset          | Unsigned  |
| Freeze demand                |         | 8F70            | 1    | Write the value 1 to freeze the demand values | Unsigned  |

### DMTME multimeters

Parts of the Modbus mapping is compatible with the ABB DMTME multimeters. All registers in the following table are read only:

| Quantity           | Start Reg (Hex) | Size | Unit | Data type |
|--------------------|-----------------|------|------|-----------|
| Phase Voltage L1-N | 1002            | 2    | Volt | Unsigned  |
| Phase Voltage L2-N | 1004            | 2    | Volt | Unsigned  |
| Phase Voltage L3-N | 1006            | 2    | Volt | Unsigned  |
| Line Voltage L1-L2 | 1008            | 2    | Volt | Unsigned  |
| Line Voltage L2-L3 | 100A            | 2    | Volt | Unsigned  |
| Line Voltage L1-L3 | 100C            | 2    | Volt | Unsigned  |
| Line Current L1    | 1010            | 2    | mA   | Unsigned  |
| Line Current L2    | 1012            | 2    | mA   | Unsigned  |
| Line Current L3    | 1014            | 2    | mA   | Unsigned  |

| <b>Quantity</b>  | <b>Start Reg (Hex)</b> | <b>Size</b> | <b>Unit</b> | <b>Data type</b> |
|--|------------------------|-------------|-------------|------------------|
| 3-Phase Sys. Power Factor  | 1016                   | 2           | *1000       | Signed           |
| Power Factor L1  | 1018                   | 2           | *1000       | Signed           |
| Power Factor L2  | 101A                   | 2           | *1000       | Signed           |
| Power Factor L3  | 101C                   | 2           | *1000       | Signed           |
| 3-Phase Sys. Apparent Power  | 1026                   | 2           | VA          | Unsigned         |
| Apparent Power L1  | 1028                   | 2           | VA          | Unsigned         |
| Apparent Power L2  | 102A                   | 2           | VA          | Unsigned         |
| Apparent Power L3  | 102C                   | 2           | VA          | Unsigned         |
| 3-Phase Sys. Active Power  | 102E                   | 2           | Watt        | Unsigned         |
| Active Power L1  | 1030                   | 2           | Watt        | Unsigned         |
| Active Power L2  | 1032                   | 2           | Watt        | Unsigned         |
| Active Power L3  | 1034                   | 2           | Watt        | Unsigned         |
| 3-Phase Reactive power   | 1036                   | 2           | VAr         | Unsigned         |
| Reactive Power L1  | 1038                   | 2           | VAr         | Unsigned         |
| Reactive power L2  | 103A                   | 2           | VAr         | Unsigned         |
| Reactive Power L3  | 103C                   | 2           | VAr         | Unsigned         |
| 3-Phase Sys. Active energy   | 103E                   | 2           | Wh*100      | Unsigned         |
| 3-Phase Sys. Reactive energy   | 1040                   | 2           | VArh*100    | Unsigned         |
| Frequency  | 1046                   | 2           | mHz         | Unsigned         |
| Current transformer ratio (current transformer ratio secondary current must be set to 1) | 11A0                   | 2           | 1-999999    | Unsigned         |
| Voltage transformer ratio (voltage transformer ratio secondary voltage must be set to 1) | 11A2                   | 2           | 1-9999      | Unsigned         |

---

### 9.5 Historical Data

#### General

In the Modbus mapping all historical data is organized as entries. This concerns Previous values, Demand, Load profile and Event logs.

Entry number 1 is the most recent entry, entry number 2 is the second most recent, and so on. Entry number 0 is not used.

Readout of all types of historical values is made by writing to a group of registers called Header and reading from one or more groups of registers called Data blocks.

The Header is used for controlling readout with respect to date/time or entry numbers, and for loading new entries into the Data blocks. The data blocks contain the actual data, for example event log entries or energy values.

When there are no more entries to read all registers in the Data blocks are set to 0xFFFF.

#### Header registers

There are a number of standard commands that are used in the same way when reading out any type of historical data. These are represented by registers in the Header, separately mapped for each functionality, but with the same names.

The following table describes the common header registers:

| Function       | Size | Description  | Data type             | Read/write |
|----------------|------|--|-----------------------|------------|
| Get next entry | 1    | Write the value 1 to this register to load new values in the Data block(s) | Unsigned              | R/W        |
| Entry number   | 1    | Write to this register to choose an entry number to start reading from     | Unsigned              | R/W        |
| Date/Time      | 3    | Write to this register to choose a date/time to start reading from         | Date/Time (see below) | R/W        |
| Direction      | 1    | Write to this register to choose the direction of reading                  | Unsigned              | R/W        |

#### Get next entry register

The Get next entry register is used to continue an ongoing readout, which was started by writing to any of the Entry number, Date/Time or Direction registers.

If the direction in Direction register is set to backward the Data block is loaded with older data. And correspondingly, if the direction is set to forward the Data block is loaded with more recent data.

**Entry number register**

The Entry number register is used to specify an entry number to start reading from. When a value is written to the Entry number register the Data block is loaded with values for that entry number.

Subsequent writes to Get next entry register will update the Entry number register (increment or decrement depending on direction in the Direction register), as well as loading new values to the Data block.

The default value of Entry number register after a restart is 0.

---

**Date/Time register**

The Date/Time register is used to specify a date and time to start reading from. When a value is written to the Date/Time register the Data block is loaded with values for that date and time. The Entry number register is also automatically updated, to reflect which entry number the values for this date and time has.

If there is no entry for the date and time chosen, and the reading direction is set to backward, the nearest older entry will be loaded into the Data block. If the reading direction is instead forward, the nearest newer entry will be loaded.

Subsequent writes to Get next entry register will load new data into the Data block, in the order indicated by the Direction register. The Entry number register will also be automatically updated (incremented or decremented depending on the direction in the Direction register).

---

**Direction register**

The Direction register is used to control the direction in time in which the entries are read. Possible values are shown in the table below:

| Value | Description   |
|-------|---|
| 0     | Backwards, i.e. from recent entries towards older entries |
| 1     | Forward, i.e. from old entries towards recent entries     |

The default value of Entry number register after a restart is 0, i.e. backwards.

---

**Data block registers**

There are a number of standard data items that are used in the same way when reading out any type of historical data. These are represented by registers in the Data block, separately mapped for each functionality, but with the same names.

The following table describes the common Data block registers:

| Function  | Size | Description                                     | Data type       | Read /write |
|-----------|------|---|-----------------|-------------|
| Timestamp | 3    | The date and time on which the value was stored | Date/Time       | R/W         |
| Quantity  | 3    | OBIS code for the quantity concerned            | 6 byte sequence | R/W         |

| Function  | Size | Description                                       | Data type | Read /write |
|-----------|------|---|-----------|-------------|
| Data type | 1    | Data type for the value of the quantity concerned | Unsigned  | R/W         |
| Scaler    | 1    | Scaling of the value for the quantity concerned   | Signed    | R/W         |

### Timestamp

The date and time on which the value was stored. How to interpret the data in these registers is described in. "Date and time format" on page - 103

### Quantity registers

The OBIS code for a quantity in for example a load profile channel or previous values channel. A list of OBIS codes is found in "Quantity identifiers" on page - 103.

The table below shows an example of how an OBIS code is mapped to the Quantity registers. The OBIS code used is for active energy import total: 1.0.1.8.0.255.

| Byte number | Comment on byte order                      | Value (in case of active energy import total) |
|-------------|--|---|
| 0           | Most significant byte of lowest register   | 1   |
| 1           | Least significant byte of lowest register  | 0   |
| 2           | ...  | 1   |
| 3           | ...  | 8   |
| 4           | ...  | 0   |
| 5           | Least significant byte of highest register | 255   |

### Data type register

The data type register contains a data type identifier that is a value between 0 and 255. Currently only two identifiers are used for historical values. The identifier for 64 bit **unsigned** integer is 21 and the identifier for 64 bit **signed** integer is 20.

### Scaler register

The scaler register shows the resolution of the value. The measured value in the Value register should be interpreted as  $\text{value} \cdot 10^{\text{scaler}}$ . For example, the prefix kilo is represented by scaler 3 while milli is -3. An energy accumulator with the resolution 0,01 kWh consequently has scaler 1.

**Date and time format**

The same date and time format is used wherever a date and time occurs in the registers, e.g. the Date/Time register in the Header or a timestamp in the Data block. The following table shows the structure of date and time in the mapping:

| Byte number | Description | Comment on byte order                      |
|-------------|-------------|--|
| 0           | Year        | Most significant byte of lowest register   |
| 1           | Month       | Least significant byte of lowest register  |
| 2           | Day         | ...  |
| 3           | Hour        | ...  |
| 4           | Minute      | ...  |
| 5           | Second      | Least significant byte of highest register |

**Response times**

The Headers for reading out historical values include one or more of the registers Entry number, Date/Time, Direction and Get next entry for controlling the readout.

When writing to any of the registers Entry number, Date/Time or Direction a new search is started in the persistent storage, which can take a long time depending on how old the entry searched for is. The response from Modbus is given **after** the search is finished, i.e. when the requested entry has been found.

Recent entries are found fast, whereas finding the oldest can take seconds or even up to about a minute if there are many thousands of newer values. It is therefore preferable to start reading from a recent entry number or date/time and then go **backwards** in time.

Writing to the Get next entry register continues the ongoing search and consequently goes fast.

**9.5.1 Quantity identifiers**

The quantities stored in Previous values, Demand and Load profile are identified by OBIS codes. The OBIS code is a 6 byte identifier. The tables below list the OBIS codes for all quantities possible to configure.

**Total energies**

The following table lists the OBIS codes for total energies:

| Quantity                     | OBIS code      |
|------------------------------|----------------|
| Active energy import total   | 1.0.1.8.0.255  |
| Active energy export total   | 1.0.2.8.0.255  |
| Active energy net total      | 1.0.16.8.0.255 |
| Reactive energy import total | 1.0.3.8.0.255  |

| Quantity                            | OBIS code       |
|-------------------------------------|-----------------|
| Reactive energy export total        | 1.0.4.8.0.255   |
| Reactive energy net total           | 1.0.128.8.0.255 |
| Apparent energy import total        | 1.0.9.8.0.255   |
| Apparent energy export total        | 1.0.10.8.0.255  |
| Apparent energy net total           | 1.0.137.8.0.255 |
| Active energy import total CO2      | 1.0.1.8.200.255 |
| Active energy import total Currency | 1.0.1.8.220.255 |

---

### Energies per tariff

The following table lists the OBIS codes for energies per tariff:

| Quantity                        | OBIS code     |
|---------------------------------|---------------|
| Active energy import tariff 1   | 1.0.1.8.1.255 |
| Active energy import tariff 2   | 1.0.1.8.2.255 |
| Active energy import tariff 3   | 1.0.1.8.3.255 |
| Active energy import tariff 4   | 1.0.1.8.4.255 |
| Active energy export tariff 1   | 1.0.2.8.1.255 |
| Active energy export tariff 2   | 1.0.2.8.2.255 |
| Active energy export tariff 3   | 1.0.2.8.3.255 |
| Active energy export tariff 4   | 1.0.2.8.4.255 |
| Reactive energy import tariff 1 | 1.0.3.8.1.255 |
| Reactive energy import tariff 2 | 1.0.3.8.2.255 |
| Reactive energy import tariff 3 | 1.0.3.8.3.255 |
| Reactive energy import tariff 4 | 1.0.3.8.4.255 |
| Reactive energy export tariff 1 | 1.0.4.8.1.255 |
| Reactive energy export tariff 2 | 1.0.4.8.2.255 |
| Reactive energy export tariff 3 | 1.0.4.8.3.255 |
| Reactive energy export tariff 4 | 1.0.4.8.4.255 |

---

### Energies per phase

The following table lists the OBIS codes for energies per phase:

| Quantity                | OBIS code      |
|-------------------------|----------------|
| Active energy import L1 | 1.0.21.8.0.255 |
| Active energy import L2 | 1.0.41.8.0.255 |



| <b>Quantity</b>           | <b>OBIS code</b> |
|---------------------------|------------------|
| Active energy import L3   | 1.0.61.8.0.255   |
| Active energy export L1   | 1.0.22.8.0.255   |
| Active energy export L2   | 1.0.42.8.0.255   |
| Active energy export L3   | 1.0.62.8.0.255   |
| Active energy net L1      | 1.0.36.8.0.255   |
| Active energy net L2      | 1.0.56.8.0.255   |
| Active energy net L3      | 1.0.76.8.0.255   |
| Reactive energy import L1 | 1.0.23.8.0.255   |
| Reactive energy import L2 | 1.0.43.8.0.255   |
| Reactive energy import L3 | 1.0.63.8.0.255   |
| Reactive energy export L1 | 1.0.24.8.0.255   |
| Reactive energy export L2 | 1.0.44.8.0.255   |
| Reactive energy export L3 | 1.0.64.8.0.255   |
| Reactive energy net L1    | 1.0.129.8.0.255  |
| Reactive energy net L2    | 1.0.130.8.0.255  |
| Reactive energy net L3    | 1.0.131.8.0.255  |
| Apparent energy import L1 | 1.0.29.8.0.255   |
| Apparent energy import L2 | 1.0.49.8.0.255   |
| Apparent energy import L3 | 1.0.69.8.0.255   |
| Apparent energy export L1 | 1.0.30.8.0.255   |
| Apparent energy export L2 | 1.0.50.8.0.255   |
| Apparent energy export L3 | 1.0.70.8.0.255   |
| Apparent energy net L1    | 1.0.138.8.0.255  |
| Apparent energy net L2    | 1.0.139.8.0.255  |
| Apparent energy net L3    | 1.0.140.8.0.255  |

**Pulse input  
counters**

The following table lists the OBIS codes for pulse input counters:

| <b>Quantity</b> | <b>OBIS code</b> |
|-----------------|------------------|
| Input 1 counter | 1.128.82.8.0.255 |
| Input 2 counter | 1.129.82.8.0.255 |
| Input 3 counter | 1.130.82.8.0.255 |
| Input 4 counter | 1.131.82.8.0.255 |

### Averages of instrumentation values

Averages of instrumentation values are used in load profile recording.

The following table lists the OBIS codes for averaging of instrumentation values:

| Quantity           | OBIS code        |
|--------------------|------------------|
| Voltage L1         | 1.0.32.27.0.255  |
| Voltage L2         | 1.0.52.27.0.255  |
| Voltage L3         | 1.0.72.27.0.255  |
| Voltage L1-L2      | 1.0.134.27.0.255 |
| Voltage L2-L3      | 1.0.135.27.0.255 |
| Voltage L1-L3      | 1.0.136.27.0.255 |
| Current L1         | 1.0.31.27.0.255  |
| Current L2         | 1.0.51.27.0.255  |
| Current L3         | 1.0.71.27.0.255  |
| Current N          | 1.0.91.27.0.255  |
| Power factor total | 1.0.13.27.0.255  |
| Power factor L1    | 1.0.33.27.0.255  |
| Power factor L2    | 1.0.53.27.0.255  |
| Power factor L3    | 1.0.73.27.0.255  |

### Min/Max of instrumentation values and powers

Minimum and maximum of instrumentation values and powers are used for the Demand function. In the table below the byte shown as X can have any of the values 3, 6, 13 or 16. The meaning of these values is described after the OBIS code table.

The following table lists the OBIS codes for minimum/maximum of instrumentation values and powers:

| Quantity      | OBIS code       |
|---------------|-----------------|
| Voltage L1    | 1.0.32.X.0.255  |
| Voltage L2    | 1.0.52.X.0.255  |
| Voltage L3    | 1.0.72.X.0.255  |
| Voltage L1-L2 | 1.0.134.X.0.255 |
| Voltage L2-L3 | 1.0.135.X.0.255 |
| Voltage L1-L3 | 1.0.136.X.0.255 |

| Quantity          | OBIS code  |
|-------------------|--|
| Current L1        | 1.0.31.X.0.255   |
| Current L2        | 1.0.51.X.0.255   |
| Current L3        | 1.0.71.X.0.255   |
| Current N         | 1.0.91.X.0.255   |
| THD Voltage L1    | 1.0.32.X.124.254   |
| THD Voltage L2    | 1.0.52.X.124.254   |
| THD Voltage L3    | 1.0.72.X.124.254   |
| THD Voltage L1-L2 | 1.0.134.X.124.254  |
| THD Voltage L2-L3 | 1.0.135.X.124.254  |
| THD Voltage L1-L3 | 1.0.136.X.124.254  |
| THD Current L1    | 1.0.31.X.124.254   |
| THD Current L2    | 1.0.51.X.124.254   |
| THD Current L3    | 1.0.71.X.124.254   |
| THD Current N     | 1.0.91.X.124.254   |
| Powers            | Same codes as energies, but with X set to 3, 6, 13 or 16 |

**X-values**

The following table lists the meaning of the values for X:

| Value of X | Meaning  |
|------------|--|
| 3          | Minimum value of averages calculated over measurement period 1 |
| 6          | Maximum value of averages calculated over measurement period 1 |
| 13         | Minimum value of averages calculated over measurement period 2 |
| 16         | Maximum value of averages calculated over measurement period 2 |



**Note** – Measurement period 1 is currently used for block demand and measurement period 2 is used for sliding demand.

## 9.6 Previous Values



**Note** – Before you can use the information in this chapter you must be familiar with and understand the information and the concepts described in “Historical Data” on page - 100.

### Mapping table

The following table shows an overview of the mapping table:

| Function        | Details      | Start Reg (Hex) | Size |
|-----------------|--------------|-----------------|------|
| Previous values | Header       | 8000            | 16   |
| Previous values | Data block 1 | 8010            | 83   |
| Previous values | Data block 2 | 8070            | 83   |
| Previous values | Data block 3 | 80D0            | 83   |
| Previous values | Data block 4 | 8130            | 83   |
| Previous values | Data block 5 | 8190            | 83   |
| Previous values | Data block 6 | 81F0            | 83   |
| Previous values | Data block 7 | 8250            | 83   |

### Header

The following table describes the header:

| Function       | Start Reg (Hex) | Size | Description   | Read/write |
|----------------|-----------------|------|---|------------|
| Get next entry | 8000            | 1    | Write value 1 to this register to load the next block of values and timestamp | R/W        |
| Entry number   | 8001            | 1    | Write to this register to choose an entry number to start reading from        | R/W        |
| Date/Time      | 8004            | 3    | Write to this register to choose a date/time to start reading from            | R/W        |
| Direction      | 8007            | 1    | Write to this register to choose the direction of reading                     | R/W        |

### Data blocks

The Data blocks contain the history of previous values. Data block 1 to 7 have the same structure. Each block can contain up to 8 channels. Consequently, in a meter with 50 previous values channels, there are 8 channels in each of block 1 to block 6 and 2 channels in block 7.

The registers of unused channels are filled with 0xFFFF.

**Structure of the data blocks**

The following table describes the structure of the data blocks:

| Channel                 | Contents  | Start Reg (Hex) | Size | Description   |
|-------------------------|-----------|-----------------|------|---|
| Common for all channels | Timestamp | 8010            | 3    | Date and time for the end of this period, i.e. when this entry was stored. (Date/Time format) |
| Channel 1               | Quantity  | 8013            | 3    | OBIS code for the quantity stored in channel 1.   |
| Channel 1               | Data type | 8016            | 1    | Data type for quantity stored in channel 1.   |
| Channel 1               | Scaler    | 8017            | 1    | Scaler for quantity stored in channel 1.  |
| Channel 1               | Status    | 8018            | 1    | Status for quantity stored in channel 1.  |
| Channel 1               | Value     | 8019            | 4    | Value for quantity stored in channel 1.   |
| ...                     |           |                 |      |   |
| ...                     |           |                 |      |   |
| Channel 8               | Quantity  | 8059            | 3    | OBIS code for the quantity stored in channel 8.   |
| Channel 8               | Data type | 805C            | 1    | Data type for quantity stored in channel 8.   |
| Channel 8               | Scaler    | 805D            | 1    | Scaler for quantity stored in channel 8.  |
| Channel 8               | Status    | 805E            | 1    | Status for quantity stored in channel 8   |
| Channel 8               | Value     | 805F            | 4    | Value for quantity stored in channel 8.   |

**Status register**

The status register shows the status for a value stored at a given timestamp. Possible values are shown in the table below:

| Status | Description   |
|--------|---------------|
| 0      | OK            |
| 1      | Not available |
| 2      | Data error    |

**Example of data block 1**

The following table shows the relation between stored values and channels in data block 1:

| Entry | Timestamp          | Channel 1 |          | Channel 2..8 |
|-------|--------------------|-----------|----------|--------------|
|       |                    | Status    | Value    |              |
| 1     | 110601<br>00:00:00 | 0 (OK)    | 1000 kWh | ...          |
| 2     | 110501<br>00:00:00 | 0 (OK)    | 800 kWh  | ...          |
| 3     | 110401<br>00:00:00 | 0 (OK)    | 450 kWh  | ...          |

## 9.6.1 Reading Previous Values

**General**

Readout of previous values is controlled by the Entry number register or Date/Time register.

After writing to any of those registers, the values of all channels for the given entry number or date/time are available in the registers of data block 1 to 7, together with status and timestamp information.

In the data blocks, the registers Quantity, Data type and Scaler provide further information about the data stored in each channel. To get the next block of previous values, write the value 1 to the Get next entry register, and then read again from the registers in the data blocks.

**Read the most recent**

Follow the steps in the table below to read the most recent previous values entry:

| Step | Action  |
|------|---|
| 1    | Write the value 1 to the entry number register. |
| 2    | Read the data blocks of interest.               |

**Read the entire history**

Follow the steps in the table below to read the entire history of previous values:

| Step | Action  |
|------|---|
| 1    | Write the value 0 to the Entry number register to make sure the reading starts from the most recent entry.  |
| 2    | Write the value 1 to the Get next entry register.   |
| 3    | Read the data blocks of interest.   |
| 4    | Repeat steps 2 and 3 until there are no more entries stored. When all entries have been read, all registers in the data blocks are set to 0xFFFF. |



**Note** – The entry number register is reset to 0 after a restart.

---

**Read forward or backwards from a specified date/time**

Follow the steps in the table below to read forward or backwards in time from a specified date/time:

| Step | Action  |
|------|---|
| 1    | Write a date and time to the Date/Time registers.   |
| 2    | Write to the Direction register. Writing value 0 means backwards and value 1 means forward.   |
| 3    | Read the data blocks of interest.   |
| 4    | Write the value 1 to the Get next entry register.   |
| 5    | Repeat steps 3 and 4 until there are no more entries stored. When all entries have been read, all registers in the data blocks are set to 0xFFFF. |



**Note** – The Date/time registers are reset to 0xFFFF after a restart.

---

## 9.7 Demand



**Note** – Before you can use the information in this chapter you must be familiar with and understand the information and the concepts described in “Historical Data” on page - 100.

### Mapping table

The following table shows an overview of the mapping table:

| Function | Details      | Start Reg (Hex) | Size |
|----------|--------------|-----------------|------|
| Demand   | Header       | 8300            | 16   |
| Demand   | Data block 1 | 8310            | 115  |
| Demand   | Data block 2 | 8390            | 115  |
| Demand   | Data block 3 | 8410            | 115  |
| Demand   | Data block 4 | 8490            | 115  |
| Demand   | Data block 5 | 8510            | 115  |
| Demand   | Data block 6 | 8590            | 115  |
| Demand   | Data block 7 | 8610            | 115  |

### Header

The following table describes the header:

| Function       | Start Reg (Hex) | Size | Description   | Read/write |
|----------------|-----------------|------|---|------------|
| Get next entry | 8300            | 1    | Write value 1 to this register to load the next block of values and timestamp | R/W        |
| Entry number   | 8301            | 1    | Write to this register to choose an entry number to start reading from        | R/W        |
| Date/Time      | 8304            | 3    | Write to this register to choose a date/time to start reading from            | R/W        |
| Direction      | 8307            | 1    | Write to this register to choose the direction of reading                     | R/W        |

### Data blocks

The Data blocks contain the history of demand. Data block 1 to 7 have the same structure. Each block can contain up to 8 channels. Consequently, in a meter with 50 demand channels, there are 8 channels in each of block 1 to block 6 and 2 channels in block 7.

The registers of unused channels are filled with 0xFFFF.



**Structure of the data blocks**

The following table describes the structure of the data blocks:

| Channel                 | Contents     | Start Reg (Hex) | Size | Description   |
|-------------------------|--------------|-----------------|------|---|
| Common for all channels | Timestamp    | 8310            | 3    | Date and time for the end of this period, i.e. when this entry was stored. (Date/Time format) |
| Channel 1               | Quantity     | 8313            | 3    | OBIS code for the quantity monitored in channel 1.  |
| Channel 1               | Level        | 8316            | 1    | Demand level for channel 1.   |
| Channel 1               | Data type    | 8317            | 1    | Data type for quantity monitored in channel 1.  |
| Channel 1               | Scaler       | 8318            | 1    | Scaler for quantity monitored in channel 1.   |
| Channel 1               | Capture time | 8319            | 3    | Date and time when the minimum or maximum occurred for the quantity monitored in channel 1.   |
| Channel 1               | Status       | 831C            | 1    | Status for quantity monitored in channel 1.   |
| Channel 1               | Value        | 831D            | 4    | Value for quantity monitored in channel 1.  |
| ...                     |              |                 |      |   |
| ...                     |              |                 |      |   |
| Channel 8               | Quantity     | 836C            | 3    | OBIS code for the quantity monitored in channel 8.  |
| Channel 8               | Level        | 836F            | 1    | Demand level for channel 8.   |
| Channel 8               | Data type    | 8370            | 1    | Data type for quantity monitored in channel 8.  |
| Channel 8               | Scaler       | 837A            | 1    | Scaler for quantity monitored in channel 8.   |
| Channel 8               | Capture time | 837B            | 3    | Date and time when the minimum or maximum occurred for the quantity monitored in channel 8.   |
| Channel 8               | Status       | 837E            | 1    | Status for quantity monitored in channel 8.   |
| Channel 8               | Value        | 837F            | 4    | Value for quantity monitored in channel 8.  |

**Level register**

The Level register shows which demand level is configured for this channel. Possible values are shown in the table below:

| Value | Description  |
|-------|--|
| 1     | Highest/Lowest value during the demand period        |
| 2     | Second highest/lowest value during the demand period |

| Value | Description   |
|-------|---|
| 3     | Third highest/lowest value during the demand period |

---

### Capture time register

The Capture time register shows the date and time when the minimum or maximum value for this entry occurred.

---

### Status register

The status register shows the status for a value stored at a given timestamp. Possible values are shown in the table below:

| Status | Description   |
|--------|---------------|
| 0      | OK            |
| 1      | Not available |
| 2      | Data error    |

---

### Example of data block 1

The following table shows the relation between stored values and channels in data block 1:

| Entry | Timestamp          | Channel 1          |                |         | Channel 2..8 |
|-------|--------------------|--------------------|----------------|---------|--------------|
|       |                    | Capture time       | Status         | Value   |              |
| 1     | 110601<br>00:00:00 | 110515<br>01:05:00 | 0 (OK)         | 200 W   | ...          |
| 2     | 110501<br>00:00:00 | 110410<br>02:10:00 | 2 (Data error) | 10000 W | ...          |
| 3     | 110401<br>00:00:00 | 110305<br>03:15:00 | 0 (OK)         | 250 W   | ...          |

## 9.7.1 Reading Demand

---

### General

Readout of demand is controlled by the Entry number register or Date/Time register. Entry number 0 is used for current demand, that is the pending period, and entry numbers equal or bigger than 1 are used for historic demand periods.

After writing to any of those registers, the values of all channels for the given entry number or date/time are available in the registers of data block 1 to 7, together with status and timestamp information.

In the data blocks, the registers Quantity, Level, Data type and Scaler provide further information about the data stored in each channel. To get the next block of demand values, write the value 1 to the Get next entry register, and then read again from the registers in the data blocks.

**Read the most recent historic entry**

Follow the steps in the table below to read the most recent historic demand entry:

| Step | Action  |
|------|---|
| 1    | Write the value 1 to the entry number register. |
| 2    | Read the data blocks of interest.               |

**Read part of or the entire demand**

Follow the steps in the table below to read part of or the entire demand:

| Step | Action   |
|------|--|
| 1    | Write the value for the starting entry number. Entry number 0 makes the reading to start with current demand and 1 makes the reading to start with most recent historic entry. |
| 2    | Read the data blocks of interest.  |
| 3    | Write the value 1 to the Get next entry register.  |
| 4    | Repeat steps 2 and 3 as many times as required or until there are no more entries stored. When all entries have been read, all registers in the data blocks are set to 0xFFFF. |



**Note** – The entry number register is reset to 0 after a restart.

**Read forward or backwards from a specified date/time**

Follow the steps in the table below to read forward or backwards in time from a specified date/time:

| Step | Action  |
|------|---|
| 1    | Write a date and time to the Date/Time registers.   |
| 2    | Write to the Direction register. Writing value 0 means backwards and value 1 means forward.   |
| 3    | Read the data blocks of interest.   |
| 4    | Write the value 1 to the Get next entry register.   |
| 5    | Repeat steps 3 and 4 until there are no more entries stored. When all entries have been read, all registers in the data blocks are set to 0xFFFF. |



**Note** – The Date/time registers are reset to 0xFFFF after a restart.

## 9.8 Event logs



**Note** – Before you can use the information in this chapter you must be familiar with and understand the information and the concepts described in “Historical Data” on page - 100.

---

### Mapping table

The following table shows an overview of the mapping table:

| Log type        | Details    | Start Reg (Hex) | Size |
|-----------------|------------|-----------------|------|
| System log      | Header     | 6500            | 16   |
| System log      | Data block | 6510            | 105  |
| Event log       | Header     | 65B0            | 16   |
| Event log       | Data block | 65C0            | 105  |
| Net quality log | Header     | 6710            | 16   |
| Net quality log | Data block | 6720            | 105  |

---

### Header and data block

There is one pair of header and data block for each log type, located in the registers listed in the mapping table above. In the tables showing the structure of the header and data block below the register numbers are valid for the System log. However the headers and data blocks for all log types share the same structure, so the tables are applicable for all log types if the register numbers are exchanged to correct values.

---

### Structure of the header

The following table describes the header:

| Function       | Start Reg (Hex) | Size | Description  | Read/write |
|----------------|-----------------|------|--|------------|
| Get next block | 6500            | 1    | Write value 1 to this register to load the next block of log entries   | R/W        |
| Entry number   | 6501            | 1    | Write to this register to choose an entry number to start reading from | R/W        |
| Date/Time      | 6504            | 3    | Write to this register to choose a date/time to start reading from     | R/W        |
| Direction      | 6507            | 1    | Write to this register to choose the direction of reading              | R/W        |

---

### Data block

The data block contains the log entries, consisting of timestamp, event counter, event category, event id and duration. There is space for up to 15 log entries in the

data block. The log is read by repeatedly loading new values into the data block in backward or forward direction in time.

The event appearing in the first position in the data block has the entry number indicated by Entry number register. In case of backwards reading the events in the other positions follow in ascending entry number order, i.e. going towards older events. In case of forward reading the events in the other positions follow in descending entry number order, i.e. going towards more recent events.

**Structure of the data block**

The following table describes the structure of the data block:

| Entry position | Contents  | Start Reg (Hex) | Size | Description  |
|----------------|-----------|-----------------|------|--|
| 1              | Timestamp | 6510            | 3    | Date and time when the event occurred (Date/Time format)                   |
| 1              | Category  | 6513            | 1    | The category of this log entry (exception, warning, error or information). |
| 1              | Event id  | 6514            | 1    | The id for this log entry, identifying what has happened.                  |
| 1              | Duration  | 6515            | 2    | The duration of this event measured in seconds.                            |
| ...            |           |                 |      |  |
| ...            |           |                 |      |  |
| 15             | Timestamp | 6572            | 3    | Date and time when the event occurred (Date/Time format)                   |
| 15             | Category  | 6575            | 1    | The category of this log entry (exception, warning, error or information). |
| 15             | Event id  | 6576            | 1    | The id for this log entry, identifying what has happened.                  |
| 15             | Duration  | 6577            | 2    | The duration of this event measured in seconds.                            |

**Category**

Possible values for the category register are shown in the table below:

| Category | Description |
|----------|-------------|
| 1        | Exception   |
| 2        | Error       |
| 4        | Warning     |
| 8        | Information |

## 9.8.1 Reading Event logs

### General

Readout of logs is controlled by the Entry number register or the Date/Time register. After writing to the Entry number register or the Date/Time register, the log entries are available in the registers of the data block. To get the next set of entries the Get next entry register is used.

---

### Read the 15 most recent logs

Follow the steps in the table below to read the 15 most recent log entries:

| Step | Action  |
|------|---|
| 1    | Write the value 1 to the entry number register. |
| 2    | Read the data block.                            |

---

### Read the entire history

Follow the steps in the table below to read the entire history of logs, backwards in time:

| Step | Action   |
|------|--|
| 1    | Write the value 0 to the Entry number register to make sure the reading starts from the most recent entry.   |
| 2    | Write the value 1 to the Get next entry register.  |
| 3    | Read the data block.<br>First time this step is performed the logs in the data block are the most recent up to the 15th most recent. Second time this step is performed the logs in the data block are the 16th to the 30th. |
| 4    | Repeat steps 2 and 3 until there are no more entries stored. When all entries have been read, all registers in the data block are set to 0xFFFF.   |

---



**Note** – The entry number register is reset to 0 after a restart.

---

### Read forward or backwards from a specified date/time

Follow the steps in the table below to read forward or backwards in time from a specified date/time:

| Step | Action   |
|------|--|
| 1    | Write a date and time to the Date/Time registers.  |
| 2    | Write to the Direction register. Writing value 0 means backwards and value 1 means forward.  |
| 3    | Read data block.   |
| 4    | Write the value 1 to the Get next entry register.  |
| 5    | Repeat steps 3 and 4 until there are no more entries stored. When all entries have been read, all registers in the data block are set to 0xFFFF. |

---



**Note** – The Date/time registers are reset to 0xFFFF after a restart.

---

## 9.9 Load profile



**Note** – Before you can use the information in this chapter you must be familiar with and understand the information and the concepts described in “Historical Data” on page - 100.

### Mapping table

The following table shows an overview of the mapping table:

| Quantity     | Details             | Start Reg (Hex) | Size |
|--------------|---------------------|-----------------|------|
| Load profile | Header              | 8700            | 16   |
| Load profile | Channel information | 8710            | 7    |
| Load profile | Data block          | 8720            | 120  |

### Structure of the header

The following table describes the header:

| Function       | Start Reg (Hex) | Size | Description   | Read/write |
|----------------|-----------------|------|---|------------|
| Get next block | 8700            | 1    | Write value 1 to this register to load the next block of load profile entries     | R/W        |
| Channel number | 8703            | 1    | Write to this register to choose a load profile channel. Possible values are 1-8. | R/W        |
| Date/Time      | 8704            | 3    | Write to this register to choose a date/time to start reading from                | R/W        |
| Direction      | 8707            | 1    | Write to this register to choose the direction of reading                         | R/W        |

### Structure of the channel information

The following table describes the channel information registers:

| Function  | Start Reg (Hex) | Size | Description  | Read/write |
|-----------|-----------------|------|--|------------|
| Quantity  | 8710            | 3    | OBIS code for the quantity stored in this channel                            | R/W        |
| Scaler    | 8713            | 1    | Scaling of the values stored in this channel                                 | R/W        |
| Interval  | 8714            | 2    | Interval with which values are stored in this channel. Expressed in minutes. | R/W        |
| Data type | 8716            | 1    | Data type of the values stored in this channel                               | R/W        |

### Data block

The data block contains the load profile entries, consisting of timestamp, status and value. There is space for up to 15 entries in the data block. The load profile is read by repeatedly loading new values into the data block in backward or forward direction in time.

In case of backwards reading the entries in the data block are placed in ascending entry number order, i.e. going towards older entries. In case of forward reading the entries are placed in descending entry number order, i.e. going towards more recent entries.

### Structure of the data block

The following table describes the structure of the data block:

| Entry position | Contents  | Start Reg (Hex) | Size | Description   |
|----------------|-----------|-----------------|------|---|
| 1              | Timestamp | 8720            | 3    | Date and time when the entry was stored. (Date/Time format) |
| 1              | Status    | 8723            | 1    | The status for this entry                                   |
| 1              | Value     | 8724            | 4    | The value for this entry                                    |
| ...            |           |                 |      |   |
| ...            |           |                 |      |   |
| 15             | Timestamp | 8789            | 3    | Date and time when the entry was stored. (Date/Time format) |
| 15             | Status    | 8792            | 1    | The status for this entry                                   |
| 15             | Value     | 8793            | 4    | The value for this entry                                    |

### Status register

The status register holds status information for a load profile entry.

The following table describes the meaning of the individual bits in the status register:

| Bit number | Contents        | Description  |
|------------|-----------------|--|
| 0          | Entry available | This bit is set if the value register contains a valid value   |
| 1          | Restart         | This bit is set if a restart occurred during the interval  |
| 2          | Interval long   | This bit is set if the interval was longer than the configured interval. This happens if the date and time have been adjusted backwards in time. |



| Bit number | Contents       | Description   |
|------------|----------------|---|
| 3          | Interval short | This bit is set if the interval was shorter than the configured interval. This happens if the date and time have been adjusted forward in time. |
| 4          | Time change    | This bit is set if an adjustment to the date and time was made during the interval  |
| 5          | Bad value      | This bit is set if the value register contains a doubtful value   |
| 6-7        | Not used       |   |



**Note** – Bit 0 in the table above refers to the least significant bit in the register.

### 9.9.1 Reading Load profile

#### General

Readout of load profile is controlled by the Date/Time register. After writing to the Date/Time register, the load profile entries are available in the registers of the data block. To get the next set of entries the Get next entry register is used.

#### Read the 15 most recent entries

Follow the steps in the table below to read the 15 most recent load profile entries:

| Step | Action  |
|------|---|
| 1    | Write a date and time in the future to the Date/Time registers, e.g. 2099-01-01 00:00:00. |
| 2    | Write the value 0 to the Direction register.  |
| 3    | Read the data block.  |

#### Read forward or backwards from a specified date/time

Follow the steps in the table below to read forward or backwards in time from a specified date/time:

| Step | Action   |
|------|--|
| 1    | Write a date and time to the Date/Time registers.  |
| 2    | Write to the Direction register. Writing value 0 means backwards and value 1 means forward.  |
| 3    | Read data block.   |
| 4    | Write the value 1 to the Get next entry register.  |
| 5    | Repeat steps 3 and 4 until there are no more entries stored. When all entries have been read, all registers in the data block are set to 0xFFFF. |



**Note** – The Date/time registers are reset to 0xFFFF after a restart.

## 9.10 Configuration

---

### Introduction

This section describes how to configure the following functions:

- Previous values
  - Demand
  - Load profile
  - Alarms
  - I/O
  - Tariffs
- 

### 9.10.1 Previous values

---

#### General

Previous values configuration defines the set of quantities to store at the end of a period. It is also defines the period with which values are stored.

---

#### Mapping table

The following table shows an overview of the mapping table:

| Quantity        | Details                | Start Reg (Hex) | Size |
|-----------------|------------------------|-----------------|------|
| Previous values | Quantity configuration | 8C50            | 5    |
| Previous values | Period configuration   | 8C55            | 1    |

---

#### Quantity configuration registers

The following table describes the group of registers for configuring quantities to store in previous values:

| Function           | Start Reg (Hex) | Size | Description  | Read/write |
|--------------------|-----------------|------|--|------------|
| Number of channels | 8C50            | 1    | The number of channels used (up to a maximum of 50)          | R/W        |
| Channel number     | 8C51            | 1    | Current channel number during read or write of configuration | R          |
| Quantity           | 8C52            | 3    | OBIS code for the quantity in this channel                   | R/W        |

---

#### Write quantity configuration

Follow the steps in the table below to configure the set of quantities to store in previous values:

| Step | Action  |
|------|---|
| 1    | Write the number of channels that shall be configured to the Number of channels register. This is a value between 1 and 50. |

| Step | Action   |
|------|--|
| 2    | Write the OBIS code for the quantity to store in the first channel to the Quantity registers.                    |
| 3    | Repeat step 2 for all channels that shall be used, i.e. the same number of times as the value written in step 1. |

**Read quantity configuration**

Follow the steps in the table below to read the current configuration of quantities to store in previous values:

| Step | Action  |
|------|---|
| 1    | Read the Number of channels register to find out how many channels are used.  |
| 2    | Read from the Quantity registers to get the OBIS code for the quantity configured in the first channel.   |
| 3    | Repeat step 2 for each channel, until all OBIS codes have been read. This means step 2 shall be performed the same number of times as the value read from the Number of channels register |



**Note** – Step 1 initiates the readout procedure and can NOT be left out, even if the number of channels used is already known.



**Note** – The Channel number register can optionally be read together with the Quantity registers in step 2. The Channel number register holds the current channel number, starting from 1 after reading the Number of channels register. It is incremented every time the Quantity registers are read.

**Period configuration register**

The Period configuration register is used to read or write the period with which previous values are stored. The table below describes the contents of the Period configuration register:

| Byte nr       | Description                            | Possible values                        |
|---------------|--|--|
| 0 (High byte) | Previous values period                 | 0 = Daily<br>1 = Weekly<br>2 = Monthly |
| 1 (Low byte)  | Day of week, in case of weekly storage | 1-7 (1 = Monday)                       |

**9.10.2 Demand**

**General**

Demand configuration defines the set of quantities to store at the end of a period and the number of levels for these quantities. It is also defines the period with which values are stored, and the intervals for calculation of minimum and maximum values.

## Mapping table

The following table shows an overview of the mapping table:

| Quantity | Details                    | Start Reg (Hex) | Size |
|----------|----------------------------|-----------------|------|
| Demand   | Quantity configuration     | 8C30            | 5    |
| Demand   | Level configuration        | 8C35            | 4    |
| Demand   | Interval configuration     | 8C39            | 1    |
| Demand   | Sub interval configuration | 8C3A            | 1    |
| Demand   | Period configuration       | 8C3B            | 1    |

## Quantity configuration registers

The following table describes the group of registers for configuring quantities to store in demand:

| Function             | Start Reg (Hex) | Size | Description   | Read/write |
|----------------------|-----------------|------|---|------------|
| Number of quantities | 8C30            | 1    | The number of quantities to store in Demand (up to a maximum of 50) | R/W        |
| Quantity number      | 8C31            | 1    | Current quantity number during read or write of configuration       | R          |
| Quantity             | 8C32            | 3    | OBIS code for the quantity  | R/W        |

## Write quantity configuration

Follow the steps in the table below to configure the set of quantities to store in demand:

| Step | Action  |
|------|---|
| 1    | Write the number of quantities that shall be configured to the Number of quantities register. This is a value between 1 and 50. |
| 2    | Write the OBIS code for the first quantity to the Quantity registers.   |
| 3    | Repeat step 2 for all quantities that shall be used, i.e. the same number of times as the value written in step 1.              |

## Read quantity configuration

Follow the steps in the table below to read the current configuration of quantities to store in demand:

| Step | Action   |
|------|--|
| 1    | Read the Number of quantities register to find out how many quantities are used.   |
| 2    | Read from the Quantity registers to get the OBIS code for the first quantity.  |
| 3    | Repeat step 2 for each quantity, until all OBIS codes have been read. This means step 2 shall be performed the same number of times as the value read from the Number of quantities register |



**Note** – Step 1 initiates the readout procedure and can NOT be left out, even if the number of quantities used is already known.



**Note** – The Quantity number register can optionally be read together with the Quantity registers in step 2. The Quantity number register holds the current quantity number, starting from 1 after reading the Number of quantities register. It is incremented every time the Quantity registers are read.

**Level configuration registers**

The following table describes the group of registers for configuring the number of levels for all quantities stored in demand:

| Function         | Start Reg (Hex) | Size | Description                                | Read/write |
|------------------|-----------------|------|--|------------|
| Level quantity   | 8C35            | 3    | OBIS code for the quantity                 | R/W        |
| Number of levels | 8C38            | 1    | Number of levels to store for the quantity | R/W        |

**Write level configuration**

Follow the steps in the table below to configure the number of levels for each of the quantities stored in demand:

| Step | Action  |
|------|---|
| 1    | Write the OBIS code for the first quantity to the Level quantity registers.   |
| 2    | Write the number of levels to use for the quantity chosen in step 1 to the Number of levels register. Allowed values are 1-3. |
| 3    | Repeat step 1 and 2 for all quantities used in demand.  |



**Note** – It is assumed that the set of quantities, i.e. the OBIS codes, to store in demand has already been configured by performing the steps under Write quantity configuration. Writing an OBIS code in step 1 above does NOT add it to the set of quantities to store.

**Read level configuration**

Follow the steps in the table below to read the current configuration of levels for all quantities stored in demand:

| Step | Action   |
|------|--|
| 1    | Write the OBIS code for the first quantity to the Level quantity registers.                          |
| 2    | Read the number of levels used for the quantity chosen in step 1 from the Number of levels register. |
| 3    | Repeat step 1 and 2 for all quantities used in demand.   |



**Note** – It is assumed that the set of quantities, i.e. the OBIS codes, stored in demand is already known. Otherwise the steps under Read quantity configuration must be performed first to find these.

### Interval configuration register

The Interval configuration register is used to read or write the length of the period with which average values are calculated. The interval is expressed in minutes.

---

### Sub interval configuration register

The Sub interval configuration register is used to read or write the length of the short period in case of sliding demand. The sub interval is expressed in minutes.

---

### Period configuration register

The Period configuration register is used to read or write the period with which demand values are stored. The table below describes the contents of the Period configuration register:

---

| Byte nr       | Description                            | Possible values                        |
|---------------|--|--|
| 0 (High byte) | Demand period                          | 0 = Daily<br>1 = Weekly<br>2 = Monthly |
| 1 (Low byte)  | Day of week, in case of weekly storage | 1-7 (1 = Monday)                       |

## 9.10.3 Load profile

---

### General

Load profile configuration defines the quantity to store for each channel. It is also defines the interval by which values are stored and the maximum number of snapshots. All settings are individual for every channel.

---

### Mapping table

The following table shows the registers used for load profile configuration:

| Quantity     | Details                 | Start Reg (Hex) | Size |
|--------------|-------------------------|-----------------|------|
| Load profile | Channel number          | 8C20            | 1    |
| Load profile | Quantity                | 8C21            | 3    |
| Load profile | Interval                | 8C24            | 2    |
| Load profile | Max number of snapshots | 8C26            | 2    |

---

### Write channel configuration

Follow the steps in the table below to configure all load profile channels:

| Step | Action  |
|------|---|
| 1    | Choose the channel to configure by writing a number to the Channel number register. Allowed values are 1-8. |

| Step | Action  |
|------|---|
| 2    | Write the OBIS code for the quantity to store in the chosen channel to the Quantity registers.      |
| 3    | Write the desired storing interval to the Interval registers. The interval is expressed in minutes. |
| 4    | Write the desired maximum number of snapshots to the Max number of snapshots registers.             |
| 5    | Repeat steps 1 to 4 for all channels.   |

**Read channel configuration**

Follow the steps in the table below to read the current configuration of the load profile channels:

| Step | Action   |
|------|--|
| 1    | Choose the channel to read configuration for by writing a number to the Channel number register. Allowed values are 1-8.         |
| 2    | Read from the Quantity registers to get the OBIS code for the quantity configured in the chosen channel.                         |
| 3    | Read from the Interval registers to get the storing interval for the chosen channel. The interval is expressed in minutes.       |
| 4    | Read from the Max number of snapshots registers to get the maximum number of snapshots that can be stored in the chosen channel. |
| 5    | Repeat steps 1 to 4 for all channels.  |

**9.10.4 Alarms**

**General**

Alarm configuration defines the set of quantities to monitor. It is also defines the threshold values, delays and actions to perform for each alarm. Each alarm is configured individually.

**Alarm configuration registers**

The following table describes the group of registers for configuring the alarm parameters:

| Function     | Start Reg (Hex) | Size | Description  | Read/write |
|--------------|-----------------|------|--|------------|
| Alarm number | 8C60            | 1    | The number (identifier) for the alarm to configure               | R/W        |
| Quantity     | 8C61            | 3    | The quantity to monitor  | R/W        |
| Thresholds   | 8C64            | 8    | ON and OFF thresholds to used to decide when the alarm is active | R/W        |

| Function | Start Reg (Hex) | Size | Description  | Read/write |
|----------|-----------------|------|--|------------|
| Delays   | 8C6C            | 4    | ON and OFF delays, defining the time that the measured value must be above/below the configured thresholds before the alarm triggers | R/W        |
| Actions  | 8C70            | 2    | Actions to perform when alarm is triggered   | R/W        |

### Quantity identifiers

The following table lists the OBIS codes for the quantities that can be monitored by an alarm:

| Quantity             | OBIS code        |
|----------------------|------------------|
| Voltage L1           | 1.0.32.7.0.255   |
| Voltage L2           | 1.0.52.7.0.255   |
| Voltage L3           | 1.0.72.7.0.255   |
| Voltage L1-L2        | 1.0.134.7.0.255  |
| Voltage L2-L3        | 1.0.135.7.0.255  |
| Voltage L1-L3        | 1.0.136.7.0.255  |
| Current L1           | 1.0.31.7.0.255   |
| Current L2           | 1.0.51.7.0.255   |
| Current L3           | 1.0.71.7.0.255   |
| Current N            | 1.0.91.7.0.255   |
| Active power total   | 1.0.16. 7.0.255  |
| Active power L1      | 1.0.36. 7.0.255  |
| Active power L2      | 1.0.56. 7.0.255  |
| Active power L3      | 1.0.76. 7.0.255  |
| Reactive power total | 1.0.128. 7.0.255 |
| Reactive power L1    | 1.0.129. 7.0.255 |
| Reactive power L2    | 1.0.130. 7.0.255 |
| Reactive power L3    | 1.0.131. 7.0.255 |
| Apparent power total | 1.0.137. 7.0.255 |
| Apparent power L1    | 1.0.138. 7.0.255 |
| Apparent power L2    | 1.0.139. 7.0.255 |



| <b>Quantity</b>                  | <b>OBIS code</b>      |
|----------------------------------|-----------------------|
| Apparent power L3                | 1.0.140.7.0.255       |
| Power factor total               | 1.0.13.7.0.255        |
| Power factor L1                  | 1.0.33.7.0.255        |
| Power factor L2                  | 1.0.53.7.0.255        |
| Power factor L3                  | 1.0.73.7.0.255        |
| Harmonic voltage L1              | 1.0.32.7.124.255      |
| Harmonic voltage L2              | 1.0.52.7.124.255      |
| Harmonic voltage L3              | 1.0.72.7.124.255      |
| Harmonic voltage L1-L2           | 1.0.134.7.124.255     |
| Harmonic voltage L2-L3           | 1.0.135.7.124.255     |
| Harmonic voltage L1-L3           | 1.0.136.7.124.255     |
| Harmonic current L1              | 1.0.31.7.124.255      |
| Harmonic current L2              | 1.0.51.7.124.255      |
| Harmonic current L3              | 1.0.71.7.124.255      |
| Harmonic current Neutral         | 1.0.91.7.124.255      |
| Inactive (deactivates the alarm) | 1.128.128.128.128.128 |

---

**Thresholds registers**

The Thresholds registers are used to read and write the ON and OFF threshold values for an alarm. The scaling is the same as where the quantity appears in the normal mapping tables. The first (lowest) 4 registers are the ON threshold and the last 4 registers are the OFF threshold. Data type is signed 64 bit integer.

---

**Delays registers**

The Delays registers are used to read or write the ON and OFF delays for an alarm. The delay is expressed in milliseconds. The first (lowest) 2 registers are the ON delay and the last 2 registers are the OFF delay. Data type is unsigned 32 bit integer.

---

**Actions registers**

The Actions registers are used to read or write the actions to be performed when an alarm triggers. The first (lowest) register holds the actions to perform. The

second register holds the number of the output to set, in case Set output action is used.

| Register nr (Hex) | Bit number                   | Description   | Possible values                      |
|-------------------|------------------------------|---|--------------------------------------|
| 8C72              | 0<br>(least significant bit) | Write entry to log  | 1 = use this action<br>0 = don't use |
|                   | 1                            | Set output  | 1 = use this action<br>0 = don't use |
|                   | 2                            | Set bit in alarm register   | 1 = use this action<br>0 = don't use |
|                   | 3 - 15                       | Not used  |                                      |
| 8C73              | (Entire register)            | Number of the output to turn on. Ignored if Set output bit above is set to 0. | 1-4                                  |



**Note** – Both registers in the table above must be written in one operation, otherwise the value will not take effect.

---

### Write alarm configuration

Follow the steps in the table below to configure the parameters for monitoring the value of a number of quantities in the meter:

| Step | Action   |
|------|--|
| 1    | Write the number of the alarm to configure to the Alarm number register. This is a value between 1 and 25. |
| 2    | Write the OBIS code for the quantity to monitor to the Quantity registers.                                 |
| 3    | Write the ON and OFF thresholds to the Thresholds registers.   |
| 4    | Write the ON and OFF delays to the Delays registers.   |
| 5    | Write the actions to perform to perform to the Action registers.   |
| 6    | Repeat step 1 to 4 for all alarms that shall be used.  |

---

### Read alarm configuration

Follow the steps in the table below to read the current configuration of monitoring parameters for alarms.

| Step | Action  |
|------|---|
| 1    | Write the number of the alarm to read configuration for to the Alarm number register. This is a value between 1 and 25. |
| 2    | Read the Quantity registers to get the quantity monitored in the chosen alarm.  |
| 3    | Read the Thresholds registers to get the ON and OFF thresholds.   |
| 4    | Read the Delays registers to get the ON and OFF delays.   |
| 5    | Read the Action registers to get the actions performed when an alarm is triggered.                                      |

| Step | Action                             |
|------|------------------------------------|
| 6    | Repeat step 1 to 4 for all alarms. |

### 9.10.5 Inputs and outputs

#### General

Inputs and outputs configuration defines the function for each physical I/O port. It also defines the parameters for the logical pulse outputs.

#### Mapping table

The following table shows an overview of the mapping table:

| Quantity           | Details                    | Start Reg (Hex) | Size |
|--------------------|----------------------------|-----------------|------|
| Inputs and outputs | I/O port configuration     | 8C0C            | 4    |
| Inputs and outputs | Pulse output configuration | 8C10            | 12   |

#### I/O port configuration registers

The following table describes the group of registers for configuring the function for physical I/O ports:

| Register   | Start Reg (Hex) | Size | Description                 | Read/write |
|------------|-----------------|------|-----------------------------|------------|
| I/O port 1 | 8C0C            | 1    | Function of first I/O port  | R/W        |
| I/O port 2 | 8C0D            | 1    | Function of second I/O port | R/W        |
| I/O port 3 | 8C0E            | 1    | Function of third I/O port  | R/W        |
| I/O port 4 | 8C0F            | 1    | Function of fourth I/O port | R/W        |

The following table lists the possible values for I/O port function:

| Value | Function             |
|-------|----------------------|
| 0     | Input                |
| 1     | Communication output |
| 2     | Alarm output         |
| 3     | Pulse output         |
| 4     | Tariff output        |
| 5     | Output always ON     |
| 6     | Output always OFF    |

### Pulse output configuration registers

The following table describes the group of registers for configuring the pulse outputs:

| Function                        | Start Reg (Hex) | Size | Description  | Read/write |
|---------------------------------|-----------------|------|--|------------|
| Pulse output instance           | 8C10            | 1    | The instance number of the pulse output  | R/W        |
| Port number                     | 8C11            | 1    | The physical I/O port on which the pulses are sent out   | R/W        |
| Energy quantity                 | 8C12            | 3    | The OBIS code for the quantity   | R/W        |
| Pulse frequency active energy   | 8C15            | 2    | The pulse frequency, measured in pulses/kWh with 3 decimals. This is relevant only if Energy quantity is set to active energy.     | R/W        |
| Pulse frequency reactive energy | 8C17            | 2    | The pulse frequency, measured in pulses/kvarh with 3 decimals. This is relevant only if Energy quantity is set to reactive energy. | R/W        |
| Pulse length                    | 8C19            | 2    | The duration of a pulse, measured in milliseconds  | R/W        |
| Turn off pulse output           | 8C1B            | 1    | Write the value 1 to this register to turn off the chosen pulse output instance  | R/W        |

### Selectable energy quantities

The table below lists the possible energy quantities to associate with a pulse output:

| Quantity                     | OBIS code     |
|------------------------------|---------------|
| Active energy import total   | 1.0.1.8.0.255 |
| Active energy export total   | 1.0.2.8.0.255 |
| Reactive energy import total | 1.0.3.8.0.255 |
| Reactive energy export total | 1.0.4.8.0.255 |

### Write pulse output configuration

Follow the steps in the table below to configure the pulse outputs:

| Step | Action   |
|------|--|
| 1    | Choose the pulse output instance to configure by writing a number to the Pulse output instance register. Allowed values are 1-4.   |
| 2    | Write to the Port number register to decide to which physical port the pulses are sent out for the chosen pulse output. Allowed values are 0-4, where 0 means No Output. |
| 3    | Write the OBIS code of the quantity that shall be used for the chosen pulse output to the Energy quantity registers. Possible OBIS codes are listed above.               |

| Step | Action   |
|------|--|
| 4    | Write the desired pulse frequency to the Pulse frequency active or reactive energy registers, depending on the chosen energy type. |
| 5    | Write the desired pulse length to the Pulse length registers.  |
| 6    | Repeat steps 1 to 5 for all pulse outputs.   |

**Turn off a pulse output**

Follow the steps in the table below to turn off a pulse output instance:

| Step | Action   |
|------|--|
| 1    | Choose the pulse output instance to configure by writing a number to the Pulse output instance register. Allowed values are 1-4. |
| 2    | Write the value 1 to the Turn off pulse output register.   |

**Read pulse output configuration**

Follow the steps in the table below to read the current pulse output configuration:

| Step | Action  |
|------|---|
| 1    | Choose the pulse output instance to read configuration for by writing a number to the Pulse output instance register. Allowed values are 1-4.                           |
| 2    | Read the Port number register to get the I/O port number used by the chosen pulse output instance.  |
| 3    | Read the Energy quantity registers to get the OBIS code of the quantity used for the chosen pulse output instance.  |
| 4    | Read the Pulse frequency active or reactive energy registers, depending on the chosen energy type, to get the pulse frequency used by the chosen pulse output instance. |
| 5    | Read the Pulse length registers to get the pulse length used by the chosen pulse output instance.   |
| 6    | Repeat steps 1 to 5 for all pulse outputs.  |

**9.10.6 Tariffs**

**General**

Tariff configuration defines the currently used tariff source, i.e. communication, clock or inputs. It also defines the settings that are specific for each of these sources.

**Mapping table**

The following table shows an overview of the mapping table:

| Quantity | Details              | Start Reg (Hex) | Size |
|----------|----------------------|-----------------|------|
| Tariffs  | Tariff source        | 8C90            | 1    |
| Tariffs  | Input configuration  | 8C91            | 1    |
| Tariffs  | Season configuration | 8C92            | 35   |

| Quantity | Details                    | Start Reg (Hex) | Size |
|----------|----------------------------|-----------------|------|
| Tariffs  | Week profile configuration | 8CB5            | 24   |
| Tariffs  | Day profile configuration  | 8CCD            | 6    |
| Tariffs  | Special days configuration | 8CD3            | 5    |

### Tariff source register

The Tariff source register is used to read or write the source used for controlling the tariffs. Possible values are listed in the table below:

| Value | Description      |
|-------|------------------|
| 0     | Clock (Calendar) |
| 1     | Communication    |
| 2     | Inputs           |

### Input configuration register

The Input configuration register is used for reading and writing tariff input configuration. It decides how many tariffs are used, and which tariff is activated for every combination of values on the inputs. The following table describes the contents of the Input configuration register:

| Byte          | Bits        | Description  | Possible values         |
|---------------|-------------|--|-------------------------|
| 0 (high byte) | Entire byte | The number of tariffs to use                             | 1-4                     |
| 1 (low byte)  | 0-1*        | Tariff to activate when both inputs are OFF              | 0-3 (0 = tariff 1, etc) |
|               | 2-3*        | Tariff to activate when input 3 is ON and input 4 is OFF | 0-3                     |
|               | 4-5*        | Tariff to activate when input 3 is OFF and input 4 is ON | 0-3                     |
|               | 6-7*        | Tariff to activate when both inputs are ON               | 0-3                     |

\* Bit 0 is the least significant bit.

### Season configuration registers

The following table describes the group of registers for configuring seasons:

| Function          | Start Reg (Hex) | Size | Description   | Read/write |
|-------------------|-----------------|------|---|------------|
| Number of seasons | 8C92            | 1    | The number of seasons used (1-4)                            | R/W        |
| Season number     | 8C93            | 1    | Current season number during read or write of configuration | R          |

| Function | Start Reg (Hex) | Size | Description  | Read/write |
|----------|-----------------|------|--|------------|
| Season   | 8C94            | 33   | Name, start date/time and associated week profile for the season | R/W        |

**Season registers**

The following table describes the group of registers for configuring a season:

| Function     | Start Reg (Hex) | Size | Description   | Read/write |
|--------------|-----------------|------|---|------------|
| Season name  | 8C94            | 15   | The season name. Expressed as an ASCII character string, with a maximum length of 30 characters. First character is in the high byte of the lowest register. Any unused space in the end must be set to binary 0. | R/W        |
| Season start | 8CA3            | 3    | Start date/time of the season. Formatted as Date/Time. See “Date and time format” on page - 103. Hour, Minute and Second are currently not used and must be set to FF.  | R/W        |
| Week profile | 8CA6            | 15   | The name of the week profile associated with this season. Same format as Season name.   | R/W        |



**Note** – All 33 registers in the table above must be written in one operation, otherwise the values will not take effect.

**Write season configuration**

Follow the steps in the table below to write the season configuration:

| Step | Action  |
|------|---|
| 1    | Write the number of seasons to use to the Number of seasons register. This is a value between 1 and 4.          |
| 2    | Write the desired season configuration of the first season to the Season registers.                             |
| 3    | Repeat step 2 for all seasons that shall be used, i.e. the same number of times as the value written in step 1. |

**Read season configuration**

Follow the steps in the table below to read the current season configuration:

| Step | Action  |
|------|---|
| 1    | Read the Number of seasons register to find out how many seasons are used.  |
| 2    | Read from the Season registers to get the season name, start date/time and week profile associated with the first season. |

| Step | Action  |
|------|---|
| 3    | Repeat step 2 for each season, until all season configurations have been read. This means step 2 shall be performed the same number of times as the value read in step 1. |



**Note** – Step 1 initiates the readout procedure and can NOT be left out, even if the number of seasons used is already known.



**Note** – The Season number register can optionally be read together with the Season registers in step 2. The Season number register holds the current season number, starting from 1 after reading the Number of seasons register. It is incremented every time the Season registers are read.

### Week profile configuration registers

The following table describes the group of registers for configuring week profiles:

| Function                | Start Reg (Hex) | Size | Description   | Read/write |
|-------------------------|-----------------|------|---|------------|
| Number of week profiles | 8CB5            | 1    | The number of week profiles used (1-4)                            | R/W        |
| Week profile number     | 8CB6            | 1    | Current week profile number during read or write of configuration | R          |
| Week profile            | 8CB7            | 22   | Name and day IDs for the week profile                             | R/W        |

### Week profile registers

The following table describes the group of registers for configuring a week profile:

| Function          | Start Reg (Hex) | Size | Description  | Read/write |
|-------------------|-----------------|------|--|------------|
| Week profile name | 8CB7            | 15   | The week profile name. Same format as described in Season registers above. | R/W        |
| Day ID monday     | 8CC6            | 1    | Day ID for monday. Allowed values are 1-16.                                | R/W        |
| Day ID ...        | ...             | 1    | ...  | R/W        |
| Day ID sunday     | 8CCC            | 1    | Day ID for sunday. Allowed values are 1-16.                                | R/W        |



**Note** – All 22 registers in the table above must be written in one operation, otherwise the values will not take effect.



**Note** – If the tariff configuration has been performed using any other communication protocol, other values than 1-16 can occur for Day IDs. When configuring over Modbus though, the values written have to be within this range.



**Write week profile configuration**

Follow the steps in the table below to configure the week profiles:

| Step | Action  |
|------|---|
| 1    | Write the number of week profiles to use to the Number of week profiles register. This is a value between 1 and 4.    |
| 2    | Write the desired week profile configuration of the first week profile to the Week profile registers.                 |
| 3    | Repeat step 2 for all week profiles that shall be used, i.e. the same number of times as the value written in step 1. |

**Read week profile configuration**

Follow the steps in the table below to read the current week profile configuration:

| Step | Action  |
|------|---|
| 1    | Read the Number of week profiles register to find out how many week profiles are used.  |
| 2    | Read from the Week profile registers to get the week profile name and day ID:s for the first week profile.  |
| 3    | Repeat step 2 for each week profile, until all week profile configurations have been read. This means step 2 shall be performed the same number of times as the value read in step 1. |



**Note** – Step 1 initiates the readout procedure and can NOT be left out, even if the number of week profiles used is already known.



**Note** – The Week profile number register can optionally be read together with the Week profile registers in step 2. The Week profile number register holds the current week profile number, starting from 1 after reading the Number of week profiles register. It is incremented every time the Week profile registers are read.

**Day profile configuration registers**

The following table describes the group of registers for configuring day profiles:

| Function               | Start Reg (Hex) | Size | Description  | Read/write |
|------------------------|-----------------|------|--|------------|
| Number of day profiles | 8CCD            | 1    | The number of day profiles used (1-16)                           | R/W        |
| Day profile number     | 8CCE            | 1    | Current day profile number during read or write of configuration | R          |
| Number of actions      | 8CCF            | 1    | The number of actions during a day profile (1-30)                | R/W        |
| Action number          | 8CD0            | 1    | Current action number during read or write of configuration      | R          |
| Action                 | 8CD1            | 2    | Time when the action shall be performed, and what to do          | R/W        |

## Action registers

The following table describes the group of registers for configuring a day profile action:

| Function       | Byte number   | Description  |
|----------------|---------------|--|
| Execution time | 0 (High byte) | Hour when the action shall be performed.                               |
|                | 1 (Low byte)  | Minute when the action shall be performed.                             |
| Action id      | (Both bytes)  | Decides the action to perform. See the list of possible actions below. |



**Note** – Both registers in the table above must be written in one operation, otherwise the values will not take effect.

Possible actions to perform are activating tariffs and setting or resetting outputs. The possible values for action id are listed in the table below:

| Value | Description       |
|-------|-------------------|
| 0     | Activate tariff 1 |
| ...   | ...               |
| 3     | Activate tariff 4 |
| 100   | Set output 1      |
| 101   | Reset output 1    |
| ...   | ...               |
| 106   | Set output 4      |
| 107   | Reset output 4    |

## Write day profile configuration

Follow the steps in the table below to configure the day profiles:

| Step | Action   |
|------|--|
| 1    | Write the number of day profiles to use to the Number of day profiles register. This is a value between 1 and 16.                      |
| 2    | Write the number of actions to perform for the first day profile to the Number of actions register. This is a number between 1 and 30. |
| 3    | Write the execution time and action id for the first action to perform during the day to the Action registers.                         |
| 4    | Repeat step 3 for all actions that shall be performed during the day, i.e. the same number of times as the value written in step 2.    |
| 5    | Repeat step 2-4 for all day profiles, i.e. the same number of times as the value written in step 1.                                    |

**Read day profile configuration**

Follow the steps in the table below to read the current day profile configuration:

| Step | Action  |
|------|---|
| 1    | Read the Number of day profiles register to find out how many day profiles are used.                                      |
| 2    | Read the Number of actions register to find out how many actions are configured for the first day profile.                |
| 3    | Read from the Action registers to get the execution time and action id for the first action.                              |
| 4    | Repeat step 3 for all actions that are configured for the day, i.e. the same number of times as the value read in step 2. |
| 5    | Repeat step 2-4 for all day profiles, i.e. the same number of times as the value read in step 1.                          |



**Note** – Step 1 and 2 initiate the readout procedure and can NOT be left out, even if the number of day profiles and actions used are already known.



**Note** – The Day profile number register can optionally be read together with the Number of actions register in step 2. The Day profile number register holds the current day profile number, starting from 1 after reading the Number of day profiles register. It is incremented every time the last action during the day is read from Action registers. In the same way the Action number register can optionally be read together with the Action registers in step 3. The Action number register holds the current action number, starting from 1 after reading the Number of actions register. It is incremented every time the Action registers are read.

**Special days configuration registers**

The following table describes the group of registers for configuring special days:

| Function               | Start Reg (Hex) | Size | Description  | Read/write |
|------------------------|-----------------|------|--|------------|
| Number of special days | 8CD3            | 1    | The number of special days used (1-50)                           | R/W        |
| Special day number     | 8CD4            | 1    | Current special day number during read or write of configuration | R          |
| Special day            | 8CD5            | 3    | Date and associated day ID for the special day                   | R/W        |

**Special day registers**

The following table describes the group of registers for configuring a week profile:

| Contents | Register | Byte nr       | Description |
|----------|----------|---------------|-------------|
| Date     | 8CD5     | 0 (high byte) | Year        |

| Contents | Register | Byte nr | Description                            |
|----------|----------|---------|--|
|          |          | 1       | Month                                  |
|          | 8CD6     | 0       | Day                                    |
|          |          | 1       | Not used                               |
| Day id   | 8CD7     | (Both)  | Day ID associated with the special day |



**Note** – All 3 registers in the table above must be written in one operation, otherwise the values will not take effect.

### Write special day configuration

Follow the steps in the table below to configure the special days:

| Step | Action   |
|------|--|
| 1    | Write the number of special days to use to the Number of special days register. This is a value between 1 and 50.    |
| 2    | Write the desired date and day id of the first special to the Special day registers.                                 |
| 3    | Repeat step 2 for all special days that shall be used, i.e. the same number of times as the value written in step 1. |

### Read special day configuration

Follow the steps in the table below to read the current special day configuration:

| Step | Action  |
|------|---|
| 1    | Read the Number of special days register to find out how many special days are used.  |
| 2    | Read from the Special day registers to get the date and day id for the first special day.   |
| 3    | Repeat step 2 for each special day, until all special day configurations have been read. This means step 2 shall be performed the same number of times as the value read in step 1. |



**Note** – Step 1 initiates the readout procedure and can NOT be left out, even if the number of special days used is already known.



**Note** – The Special day number register can optionally be read together with the Special day registers in step 2. The Special day number register holds the current special day number, starting from 1 after reading the Number of special days register. It is incremented every time the Special day registers are read.

## 9.10.7 Daylight Savings Time

---

### General

Daylight savings time (DST) can be enabled and if enabled it has a start and end time that can be defined.

**Mapping table**

The following table shows an overview of the mapping table:

| Quantity | Details     | Start Reg (Hex) | Size |
|----------|-------------|-----------------|------|
| DST      | DST start   | 8CE6            | 2    |
| DST      | DST end     | 8CE8            | 2    |
| DST      | DST enabled | 8CEA            | 1    |

**DST start and end registers**

The following table shows the contents of the registers for configuring DST start. The structure of the DST end registers are the same as for DST start.

| Register  | Start Reg (Hex) | Size | Description   | Read/write               |
|-----------|-----------------|------|---|--------------------------|
| DST start | 8CE6            | 2    | Byte 0*: month<br>Byte 1: Day of month<br>Byte 2: Day of week, 1 = monday, 7 = sunday<br>Byte 3: Hour | R/W<br>R/W<br>R/W<br>R/W |

\* Byte 0 is the highest byte of the lowest register.

For month, day of month and day of week wild cards can be used according to the table below.

| Setting      | Wild cards available  |
|--------------|---|
| Month        | Not specified: 255  |
| Day of month | Not specified: 255<br>Last day of month: 254<br>2:nd last day of month: 253 |
| Day of week  | Not specified: 255  |
| Hour         | -   |

**DST enabled register**

The DST enabled register decides whether the DST functionality of the meter is turned on or not: 0 = off, 1 = on.

**Examples of DST start/end**

Month = 3, Day of month = 254, Day of week = 7, Hour = 2 means last sunday of march 02:00.

Month = 3, Day of month = 254, Day of week = 255, Hour = 2 means last day of march 02:00, regardless on which weekday it occurs.

Month = 3, Day of month = 2, Day of week = 7, Hour = 2 means second sunday of march 02:00.



# Chapter 10: Communication with M-Bus

**Overview**

This chapter describes how to read meter data and to send commands to the meter over M-Bus. The chapter contains information for all functionality and data for the complete A series family. For single phase meters some data does not exist, for example data for phase 2 and 3.

**In this chapter**

The following topics are covered in this chapter:

- 10.1 Bus Description ..... 145
- 10.2 Protocol Description ..... 146
  - 10.2.1 Telegram Format ..... 151
  - 10.2.2 Value Information Field codes ..... 157
  - 10.2.3 Communication process ..... 161
- 10.3 Standard Readout of Meter Data ..... 164
  - 10.3.1 Example of the 1st telegram (all values are hexadecimal) ..... 164
  - 10.3.2 Example of 2nd telegram (all values are hexadecimal) ..... 168
  - 10.3.3 Example of 3rd telegram (all values are hexadecimal) ..... 172
  - 10.3.4 Example of the 4th telegram (all values are hexadecimal) ..... 177
  - 10.3.5 Example of the 5th telegram (all values are hexadecimal) ..... 181
  - 10.3.6 Example of the 6th telegram (all values are hexadecimal) ..... 183
  - 10.3.7 Example of the 7th telegram (all values are hexadecimal) ..... 187
  - 10.3.8 Example of the 8th telegram (all values are hexadecimal) ..... 190
  - 10.3.9 Example of the 9th telegram (all values are hexadecimal) ..... 193
- 10.4 Special Readout of Meter Data ..... 196
  - 10.4.1 Readout of Load Profile Data ..... 197
  - 10.4.2 Readout of Demand Data ..... 205
  - 10.4.3 Readout of Previous Values ..... 211
  - 10.4.4 Readout of Event Log Data ..... 216
  - 10.4.5 Readout of Current Harmonics ..... 221
  - 10.4.6 Readout of Voltage Harmonics ..... 230
- 10.5 Sending Data to the Meter ..... 239
  - 10.5.1 Set tariff ..... 239
  - 10.5.2 Set primary address ..... 240
  - 10.5.3 Change baud rate ..... 240
  - 10.5.4 Reset power fail counter ..... 241
  - 10.5.5 Set Current transformer (CT) ratio - primary current ..... 241
  - 10.5.6 Set voltage transformer (VT) ratio - primary voltage ..... 242
  - 10.5.7 Set current transformer (CT) ratio - secondary current ..... 242
  - 10.5.8 Set voltage transformer (VT) ratio - secondary voltage ..... 243
  - 10.5.9 Select status information ..... 243
  - 10.5.10 Reset of stored state for input 1 ..... 244

10.5.11Reset of stored state for input 2 ..... 244  
10.5.12Reset of stored state for input 3 ..... 245  
10.5.13Reset of stored state for input 4 ..... 245  
10.5.14Reset of input counter 1 ..... 246  
10.5.15Reset of input counter 2 ..... 246  
10.5.16Reset of input counter 3 ..... 247  
10.5.17Reset of input counter 4 ..... 247  
10.5.18Set output 1 ..... 248  
10.5.19Set output 2 ..... 248  
10.5.20Set output 3 ..... 249  
10.5.21Set output 4 ..... 249  
10.5.22Reset power outage time ..... 250  
10.5.23Send password ..... 250  
10.5.24Set password ..... 250  
10.5.25Set date and time ..... 251  
10.5.26Set date ..... 252  
10.5.27Reset demand, previous values, load profile and logs ..... 252  
10.5.28Reset resettable active energy import ..... 253  
10.5.29Reset resettable active energy export ..... 253  
10.5.30Reset resettable reactive energy import ..... 254  
10.5.31Reset resettable reactive energy export ..... 254  
10.5.32Freeze demand ..... 255  
10.5.33Set write access level ..... 255  
10.5.34Set tariff source ..... 256  
10.5.35Set CO2 conversion factor ..... 256  
10.5.36Set currency conversion factor ..... 257



10.1 Bus Description

General

M-bus is a 2-wire polarity independent bus, optimized for master-slave communication with gas, water, heat and electricity meters. Number of meters on one physically connected bus is 1-250. A bus can be extended by using a repeater.

Topology

M-bus topology is flexible and star, line, tree topology or a mix of these can be used, see figure below. Ring topology can not be used. Bus termination is not required.

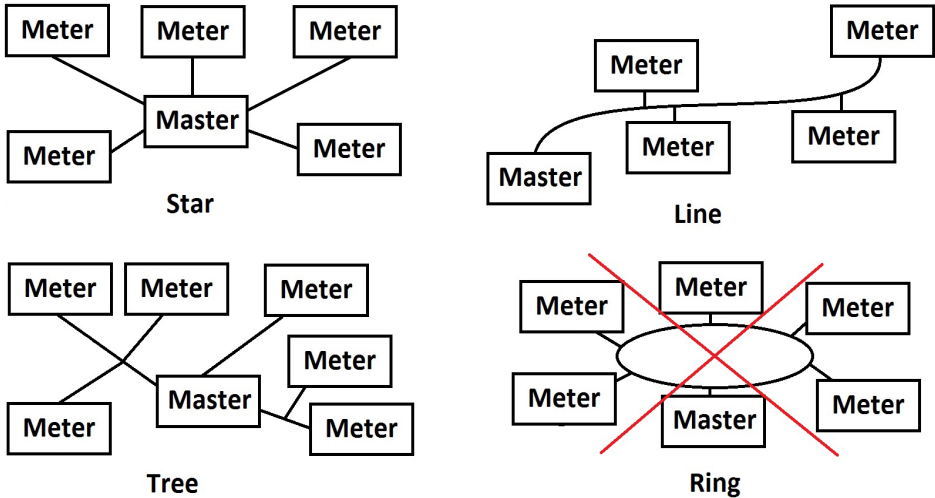

Cable

It is recommended to use non shielded twisted pair cable with wire area of 0.8 mm<sup>2</sup>, for example two-wire standard telephone cable JYStY N\*2\*0.8 mm<sup>2</sup>. If shielded cable is used the shield must not be connected to any of the two bus wires. Maximum total length of the bus is 1000 m. Maximum length between a slave and a repeater is 350 m.

## 10.2 Protocol Description

### General

The communication protocol described in this chapter meets the requirements of EN 13757-2 and EN 13757-3.

The communication can be divided in two parts. One part is reading data from the meter and the other part is sending data to it.

The data readout procedure starts when the master sends a REQ\_UD2 telegram to the meter. The meter responds with a RSP\_UD telegram. A typical readout is a multi-telegram readout.

Some data in the meter can only be read by first sending a SND\_UD followed by REQ\_UD2. This is true for load profiles, demand, log files and normally for harmonics.

Using SND\_UD telegrams data can be sent to the meter.

### Communication objects

The following quantities can be read by sending a REQ\_UD2 to the meter

| Register                         | Communication objects                        |
|----------------------------------|--|
| Active import energy, total      | Total cumulative active imported energy      |
| Active import energy, tariff 1   | Cumulative active imported energy tariff 1   |
| Active import energy, tariff 2   | Cumulative active imported energy tariff 2   |
| Active import energy, tariff 3   | Cumulative active imported energy tariff 3   |
| Active import energy, tariff 4   | Cumulative active imported energy tariff 4   |
| Reactive import energy, total    | Total cumulative reactive imported energy    |
| Reactive import energy, tariff 1 | Cumulative reactive imported energy tariff 1 |
| Reactive import energy, tariff 2 | Cumulative reactive imported energy tariff 2 |
| Reactive import energy, tariff 3 | Cumulative reactive imported energy tariff 3 |
| Reactive import energy, tariff 4 | Cumulative reactive imported energy tariff 4 |
| Active export energy, total      | Total cumulative active exported energy      |
| Active export energy, tariff 1   | Cumulative active exported energy tariff 1   |
| Active export energy, tariff 2   | Cumulative active exported energy tariff 2   |
| Active export energy, tariff 3   | Cumulative active exported energy tariff 3   |
| Active export energy, tariff 4   | Cumulative active exported energy tariff 4   |
| Reactive export energy, total    | Total cumulative reactive exported energy    |
| Reactive export energy, tariff 1 | Cumulative reactive exported energy tariff 1 |
| Reactive export energy, tariff 2 | Cumulative reactive exported energy tariff 2 |
| Reactive export energy, tariff 3 | Cumulative reactive exported energy tariff 3 |
| Reactive export energy, tariff 4 | Cumulative reactive exported energy tariff 4 |
| CT Ratio primary current         | Current transformer ratio primary current    |
| CT Ratio secondary current       | Current transformer ratio secondary current  |
| VT Ratio primary voltage         | Voltage transformer ratio primary voltage    |
| VT Ratio secondary voltage       | Voltage transformer ratio secondary voltage  |
| Outputs                          | Read and set status of outputs               |

| Register                                 | Communication objects   |
|--|---|
| Inputs, current state                    | Read current state of input 1,2, 3 and 4                      |
| Inputs, stored state                     | Read and reset stored state of input 1,2, 3 and 4             |
| Inputs, counter                          | Read and clear input pulse counter 1,2, 3 and 4               |
| Current N                                | Instantaneous current in the neutral wire                     |
| Current, L1                              | Instantaneous current in the L1 phase                         |
| Current, L2                              | Instantaneous current in the L2 phase                         |
| Current, L3                              | Instantaneous current in the L3 phase                         |
| Voltage, L1-N                            | Instantaneous voltage between L1 and neutral                  |
| Voltage, L2-N                            | Instantaneous voltage between L2 and neutral                  |
| Voltage, L3-N                            | Instantaneous voltage between L3 and neutral                  |
| Voltage, L1-L2                           | Instantaneous voltage between L1 and L2                       |
| Voltage, L2-L3                           | Instantaneous voltage between L2 and L3                       |
| Voltage, L1-L3                           | Instantaneous voltage between L1 and L3                       |
| Active Power, Total                      | Instantaneous total active power                              |
| Active Power, L1                         | Instantaneous active power in L1                              |
| Active Power, L2                         | Instantaneous active power in L2                              |
| Active Power, L3                         | Instantaneous active power in L3                              |
| Active energy net Total                  | Total cumulative active net energy                            |
| Active energy net L1                     | Cumulative active net energy in L1                            |
| Active energy net L2                     | Cumulative active net energy in L2                            |
| Active energy net L3                     | Cumulative active net energy in L3                            |
| Power factor tot.                        | Instantaneous total power factor                              |
| Power factor L1                          | Instantaneous power factor in L1                              |
| Power factor L2                          | Instantaneous power factor in L2                              |
| Power factor L3                          | Instantaneous power factor in L3                              |
| Active energy currency conversion factor | Price in currency per kWh                                     |
| Active import energy, total in Currency  | Total cumulative active imported energy expressed in currency |
| Active energy CO2 conversion factor      | CO2 emission in kg per kWh                                    |
| Active import energy, total in CO2       | Total cumulative active imported energy expressed in CO2      |
| Reactive Power, Total                    | Instantaneous total reactive power                            |
| Reactive Power, L1                       | Instantaneous reactive power in L1                            |
| Reactive Power, L2                       | Instantaneous reactive power in L2                            |
| Reactive Power, L3                       | Instantaneous reactive power in L3                            |
| Reactive energy net Tot.                 | Total cumulative reactive net energy                          |
| Reactive energy net L1                   | Cumulative reactive net energy in L1                          |
| Reactive energy net L2                   | Cumulative reactive net energy in L2                          |
| Reactive energy net L3                   | Cumulative reactive net energy in L3                          |
| Apparent Power, Total                    | Instantaneous total apparent power                            |

| Register                 | Communication objects  |
|--------------------------|--|
| Apparent Power, L1       | Instantaneous apparent power in L1                                 |
| Apparent Power, L2       | Instantaneous apparent power in L2                                 |
| Apparent Power, L3       | Instantaneous apparent power in L3                                 |
| Apparent energy net Tot. | Total cumulative apparent net energy                               |
| Apparent energy net L1   | Cumulative apparent net energy in L1                               |
| Apparent energy net L2   | Cumulative apparent net energy in L2                               |
| Apparent energy net L3   | Cumulative apparent net energy in L3                               |
| Voltage phase angle, L1  | Instantaneous voltage phase angle for L1 (L1 voltage is reference) |
| Voltage phase angle, L2  | Instantaneous voltage phase angle for L2 (L1 voltage is reference) |
| Voltage phase angle, L3  | Instantaneous voltage phase angle for L3 (L1 voltage is reference) |
| Current phase angle, L1  | Instantaneous current phase angle for L1 (L1 voltage is reference) |
| Current phase angle, L2  | Instantaneous current phase angle for L2 (L1 voltage is reference) |
| Current phase angle, L3  | Instantaneous current phase angle for L3 (L1 voltage is reference) |
| Phase angle power, Total | Instantaneous phase angle for total power                          |
| Phase angle power L1     | Instantaneous phase angle power for L1                             |
| Phase angle power L2     | Instantaneous phase angle power for L2                             |
| Phase angle power L3     | Instantaneous phase angle power for L3                             |
| Installation check       | Read result of and clear installation check                        |
| Current quadrant, Total  | Quadrant in which the meter is measuring                           |
| Current quadrant, L1     | Quadrant in which the meter is measuring, L1                       |
| Current quadrant, L2     | Quadrant in which the meter is measuring, L2                       |
| Current quadrant, L3     | Quadrant in which the meter is measuring, L3                       |
| Power fail counter       | Read and reset power fail counter                                  |
| Total power outage time  | Read and reset total power outage time                             |
| Current tariff           | Read and set current tariff  |
| Manufacturer             | Manufacturer information   |
| FW-version               | Firmware version   |
| Frequency                | Instantaneous mains frequency                                      |
| Warning flags            | Read warning flags   |
| Info flags               | Read info flags  |
| Alarm flags              | Read alarm flags   |
| Error flags              | Read error flags   |
| Date and time            | Read and set date and time   |
| Previous values          | Read previous values   |
| Load profile             | Read load profile data   |
| Demand                   | Read Demand (max. and min. data)                                   |
| Event log                | Read event log data  |

| Register                             | Communication objects                                 |
|--------------------------------------|---|
| System log                           | Read system log data                                  |
| Net quality log                      | Read net quality log data                             |
| Current harmonics                    | Read THD and harmonics on each current measured       |
| Voltage harmonics                    | Read THD and harmonics on each voltage measured       |
| Apparent import energy, total        | Total cumulative apparent imported energy             |
| Apparent export energy, total        | Total cumulative apparent exported energy             |
| Active import energy, L1             | Cumulative active imported energy in the L1 phase     |
| Active import energy, L2             | Cumulative active imported energy in the L2 phase     |
| Active import energy, L3             | Cumulative active imported energy in the L3 phase     |
| Active export energy, L1             | Cumulative active exported energy in the L1 phase     |
| Active export energy, L2             | Cumulative active exported energy in the L2 phase     |
| Active export energy, L3             | Cumulative active exported energy in the L3 phase     |
| Reactive import energy, L1           | Cumulative reactive imported energy in the L1 phase   |
| Reactive import energy, L2           | Cumulative reactive imported energy in the L2 phase   |
| Reactive import energy, L3           | Cumulative reactive imported energy in the L3 phase   |
| Reactive export energy, L1           | Cumulative reactive exported energy in the L1 phase   |
| Reactive export energy, L2           | Cumulative reactive exported energy in the L2 phase   |
| Reactive export energy, L3           | Cumulative reactive exported energy in the L3 phase   |
| Apparent import energy, L1           | Cumulative apparent imported energy in the L1 phase   |
| Apparent import energy, L2           | Cumulative apparent imported energy in the L2 phase   |
| Apparent import energy, L3           | Cumulative apparent imported energy in the L3 phase   |
| Apparent export energy, L1           | Cumulative apparent exported energy in the L1 phase   |
| Apparent export energy, L2           | Cumulative apparent exported energy in the L2 phase   |
| Apparent export energy, L3           | Cumulative apparent exported energy in the L3 phase   |
| Resettable active energy imp. Tot.   | Active imported energy accumulated since last reset   |
| Resettable active energy exp. Tot.   | Active exported energy accumulated since last reset   |
| Resettable reactive energy imp. Tot. | Reactive imported energy accumulated since last reset |
| Resettable reactive energy exp. Tot. | Reactive exported energy accumulated since last reset |

| Register   | Communication objects  |
|--|--|
| Reset counter for Resettable active energy imp. Tot.                           | Number of resets done for resettable active imported energy  |
| Reset counter for Resettable active energy exp. Tot.                           | Number of resets done for resettable active exported energy  |
| Reset counter for Resettable reactive energy imp. Tot.                         | Number of resets done for resettable reactive imported energy  |
| Reset counter for Resettable reactive energy exp. Tot.                         | Number of resets done for resettable reactive exported energy  |
| Pulse outputs, pulse frequency   | Pulse frequency for pulse outputs with unit 1-4  |
| Number of elements   | Number of elements: 1 for single phase, 2 for 3-phase without neutral, 3 for 3-phase with neutral          |
| Type designation   | In ASCII, for example "A43 513-100"  |
| Current state for Daylight Savings Time (DST), Day of week, Daytype and Season | Compound variable containing current state of Daylight Savings Time (DST), Day of week, Daytype and Season |

### Read/write commands

The following tasks are possible to perform with SND\_UD telegrams:

| Command  |
|--|
| Set tariff   |
| Set primary address                                    |
| Change baud rate                                       |
| Reset power fail counter                               |
| Reset power outage time                                |
| Set CT Ratio primary current                           |
| Set CT Ratio secondary current                         |
| Set VT Ratio primary voltage                           |
| Set VT Ratio secondary voltage                         |
| Select Status information                              |
| Reset stored state input                               |
| Reset input counters                                   |
| Set output   |
| Set date time  |
| Set date   |
| Send Password  |
| Freeze Max demand                                      |
| Set communication access level                         |
| Read Request Load profile                              |
| Read request previous values                           |
| Read request demand (maximum and minimum)              |
| Read request Log (System, Event, and Net quality Logs) |
| Read request current harmonics                         |

|                                |
|--------------------------------|
| <b>Command</b>                 |
| Read request voltage harmonics |

**10.2.1 Telegram Format**

**General**

M-Bus uses 3 different telegram formats. The formats are identified by the start character.

| Single Character | Short Frame | Long Frame              |
|------------------|-------------|-------------------------|
| E5H              | Start (10h) | Start (68h)             |
|                  | C-Field     | L-Field                 |
|                  | A-Field     | L-Field                 |
|                  | Check Sum   | Start (68h)             |
|                  | Stop (16h)  | C-Field                 |
|                  |             | A-Field                 |
|                  |             | CI-Field                |
|                  |             | User Data (0-252 Bytes) |
|                  |             | Check Sum               |
|                  |             | Stop (16h)              |

The **Single Character** format consists of a single character and is used to acknowledge received telegrams.

The **Short Frame** format is identified by its start character (10h) and consists of five characters. Besides the C- and A-fields it includes the check sum and the stop character 16h.

The **Long Frame** format is identified by its start character (68h) and consists of a variable number of characters. After the start character the L-field is transmitted twice, then the start character once again followed by the C-, A- and CI-fields. The user data (0 - 252 bytes) is transmitted after the CI-field followed by the check sum and the stop character (16h).

**10.2.1.1 Field description**

**General**

All fields in the telegram have a length of 1byte (8 bits).

**The L-Field**

The L-Field (length field) gives the size of the user data (in bytes) plus 3 (for the C-, A- and CI-Fields). It is transmitted twice in the telegrams using the long frame format.

### The C-Field

The C-Field (control field) contains information about the direction of the data flow and error handling. Besides labeling the functions and the actions caused by them, the control field specifies the direction of data flow and is responsible for various parts of the communication to and from the meter.

The following table shows the coding of the C-Field:

| Bit No.    | 7 | 6   | 5   | 4   | 3  | 2  | 1  | 0  |
|------------|---|-----|-----|-----|----|----|----|----|
| To meter   | 0 | PRM | FCB | FCV | F3 | F2 | F1 | F0 |
| From meter | 0 | PRM | 0   | 0   | F3 | F2 | F1 | F0 |

The primary message bit (**PRM**) is used to specify the direction of the data flow. It is set to 1 when a telegram is sent from a master to the meter and to 0 in the other direction.

The frame count bit valid (**FCV**) is set to 1 by the master to indicate that the frame count bit (**FCB**) is used. When the FCV is set to 0, the meter ignores the FCB.

The FCB is used to indicate successful transmission procedures. A master shall toggle the bit after a successful reception of a reply from the meter. If the expected reply is missing, or the reception of it is faulty, the master resends the same telegram with the same FCB. The meter answers, to a REQ\_UD2-request with toggled FCB and a set FCV, with a RSP\_UD containing the next telegram of a multi-telegram answer. If the FCB is not toggled it will repeat the last telegram. The actual values will be updated in a repeated telegram.

On receipt of a SND\_NKE the meter clears the FCB. The meter uses the same FCB for primary addressing, secondary addressing and point-to-point communication.

The bits 0 to 3 (F0, F1, F2 and F3) of the control field are the function code of the message. The following table shows the function codes:

| Comand  | C-Field (binary) | C-Field (hex) | Telegram    | Description                                       |
|---------|------------------|---------------|-------------|---|
| SND_NKE | 0100 0000        | 40            | Short frame | Initialization of meter                           |
| SND_UD  | 01F1 0011        | 53/73         | Long frame  | Send user data to meter                           |
| REQ_UD2 | 01F1 1011        | 5b            | Short frame | Request for class 2 data                          |
| RSP_UD  | 0000 1000        | 08            | Long frame  | Data transfer form meter to master after request. |



**A-Field**

The A-Field (address field) is used to address the recipient in the calling direction, and to identify the sender of information in the receiving direction. The size of this field is one byte, and can therefore take values from 0 to 255.

The following table shows the allocation of addresses:

| Address | Description   |
|---------|---|
| 0       | Factory default   |
| 1-250   | Can be given to meters as individual primary addresses, either via the bus (secondary addressing) or via the buttons directly on the meter. |
| 251-252 | Reserved for future use.  |
| 253     | Used by the secondary addressing procedure (FDh).   |
| 254     | Used for point-to-point communication (FEh). The meter replies with its primary address.  |
| 255     | Used for broadcast transmissions to all meters (FFh). None of the meters replies to a broadcast message.                                    |

**CI-Field**

The CI-field (control information) codes the type and sequence of application data to be transmitted in the frame. Bit two (counting begins with bit 0, value 4), called M-bit or Mode bit, in the CI-field gives information about the used byte sequence in multi-byte data structures. For communication with the meter, the Mode bit shall not be set (Mode 1) meaning the least significant byte of a multi-byte record is transmitted first.

The following table shows the codes to be used by the master:

| CI_Field codes | Application            |
|----------------|------------------------|
| 51h            | Data send              |
| 52h            | Selection of slaves    |
| B8h            | Set baud rate to 300   |
| B9h            | Set baud rate to 600   |
| Bah            | Set baud rate to 1200  |
| BBh            | Set baud rate to 2400  |
| BCh            | Set baud rate to 4800  |
| BDh            | Set baud rate to 9600  |
| BEh            | Set baud rate to 19200 |
| BFh            | Set baud rate to 38400 |

The meter uses code 72 in the CI-Field to respond to requests for user data.

### User data

The User Data contains the data to be sent to the recipient.

The following table shows the structure of the data sent from the meter to the master:

| Fixed data header | Data records             | MDH    |
|-------------------|--------------------------|--------|
| 12 bytes          | Variable number of bytes | 1 byte |

The following table shows the structure of the data sent from the master to the meter:

| Data records             |
|--------------------------|
| Variable number of bytes |

### Fixed data header

The following table shows the structure of the fixed data header:

| ID No.  | Manufacturer | Version | Medium | Access No. | Status | Signature |
|---------|--------------|---------|--------|------------|--------|-----------|
| 4 bytes | 2 bytes      | 1 byte  | 1 byte | 1 byte     | 1 byte | 2 byte    |

The following list explains the content of the fixed data header:

- **Identification No.** is the 8-digit serial number of the meter (BCD coded).
- **Manufacturer** is set to 0442h meaning ABB
- **Version** specifies the version of the protocol implementation. The meters currently use the protocol version equal to 0x20.
- **Medium** byte is set to 02h to indicate electricity.
- **Access number** is a counter that counts successful accesses.
- **Status byte** is used to indicate the meter status.

| Bit | Meaning            |
|-----|--------------------|
| 0   | Meter busy         |
| 1   | Internal error     |
| 2   | Power low          |
| 3   | Permanent error    |
| 4   | Temporary error    |
| 5   | Installation error |
| 6   | Not used           |
| 7   | Not used           |

- **Signature** is set to 00 00h

**Data records**

The data, together with information regarding coding, length and the type of data is transmitted in data records. The maximum total length of the data records is 240 bytes.

The following table shows the structure of the data record (transmitted left to right):

|                              |            |                               |            |           |
|------------------------------|------------|-------------------------------|------------|-----------|
| Data Record Header           |            |                               |            | Data      |
| Data Information Block (DIB) |            | Value Information Block (VIB) |            |           |
| DIF                          | DIFE       | VIF                           | VIFE       |           |
| 1 byte                       | 0-10 bytes | 1 byte                        | 0-10 bytes | 0-n bytes |

Each Data record consists of a data record header (DRH) and the actual data. The DRH in turn consists of the data information block (DIB) to describe the length, type and coding of the data, and the value information block (VIB) to give the value of the unit and the multiplier.

**Data information block (DIB)**

The DIB contains at least one byte (Data Information Field, DIF), and is in some cases expanded with, a maximum of 10, DIFE's (Data Information Field Extension).

The following table shows the structure of the Data Information Field (DIF):

| Bit 7         | Bit 6                           | Bit 5          | Bit 4 | Bit 3      | Bit 2 | Bit 1 | Bit 0 |
|---------------|---------------------------------|----------------|-------|------------|-------|-------|-------|
| Extension bit | LSB <sup>1</sup> of storage No. | Function Field |       | Data Field |       |       |       |

1. Least significant bit.

The following list explains the content of the DIF:

- The **Extension Bit** is set when the next byte is a DIFE.
- The **LSB of storage No.** is normally set to 0 to indicate actual value. (1=stored value).
- The **Function Field** is set to 00 for instantaneous values, 01 for maximum values and 10 for minimum values.
- The **Data Field** shows the format of the data. The following table shows the coding of the data field:

| Code | Meaning        | Length |
|------|----------------|--------|
| 0000 | No Data        | 0      |
| 0001 | 8 Bit Integer  | 1      |
| 0010 | 16 Bit Integer | 2      |
| 0100 | 32 Bit Integer | 4      |
| 0111 | 64 Bit Integer | 8      |
| 1010 | 4 digit BCD    | 2      |
| 1011 | 6 digit BCD    | 3      |
| 1100 | 8 digit BCD    | 4      |

| Code | Meaning                 | Length   |
|------|-------------------------|----------|
| 1101 | Variable Length (ASCII) | Variable |
| 1110 | 12 digit BCD            | 6        |

The following table shows the structure of the Data Information Field Extension (DIFE)

| Bit 7         | Bit 6 | Bit 5  | Bit 4 | Bit 3       | Bit 2 | Bit 1 | Bit 0 |
|---------------|-------|--------|-------|-------------|-------|-------|-------|
| Extension bit | Unit  | Tariff |       | Storage No. |       |       |       |

The following list explains the content of the DIFE:

- **Unit** is used for power and energy values show the type of power/energy. It is also used to define the number of inputs/outputs and to specify sign of offset when accessing event log data.
- **Tariff** is used for energy values to give tariff information.
- **Storage number** is set to 0 in values read to indicate momentary values. Storage number bigger than 0 is used to indicate previously stored values, i.e, values stored at a specific point of time in the past.

---

### Value Information block (VIB)

VIB follows a DIF or DIFE without extension bit. It contains one value information field (VIF) and is in some cases expanded with up to 10 value information field extensions (VIFE).

The following table shows the structure of the value information field (VIF):

| Bit 7         | 6                 | 5 | 4 | 3 | 2 | 1 | 0 |
|---------------|-------------------|---|---|---|---|---|---|
| Extension Bit | Value Information |   |   |   |   |   |   |

Value information contains information about the value (unit, status, etc.) The extension bit is set when the next byte is a VIFE.

If VIF or VIFE = FFh the next VIFE is manufacturer specific. The manufacturer specific VIFE has the same construction as a VIF. If the extension bit of the manufacturer specific VIFE is set, and the VIFE is less than 1111 1000, the next byte is a standard VIFE, otherwise it is the first data byte. If the extension bit of the manufacturer specific VIFE is set and the VIFE is bigger than or equal to 1111 1000, the next byte is an extension of manufacturer specific VIFE's.

---

### Data

The Data follows a VIF or a VIFE without the extension bit set.

---

### Manufacturer data header (MDH)

The manufacturer data header (MDH) is either made up by the character 1Fh that indicates that more data will follow in the next telegram, or by 0Fh indicating the last telegram.

**Check sum**                      The Check Sum is used to recognize transmission and synchronization faults. It is calculated from the arithmetical sum, of the bytes from the control field to the last user data, without taking carry digits into account .

**10.2.2 Value Information Field codes**

**10.2.2.1 Standard VIF codes**

| VIF-code  | Description            | Range coding  | Range   |
|-----------|------------------------|---|---|
| E000 0nnn | Energy                 | $10^{(nnn-3)}$ Wh   | 0.001Wh to 10000Wh  |
| E010 1nnn | Power                  | $10^{(nnn-3)}$ W  | 0.001W to 10000W  |
| E010 00nn | Duration               | nn = 00 seconds<br>nn = 01 minutes<br>nn = 10 hours<br>nn = 11 days |   |
| E110 110n | Time point             | n = 0: date<br>n = 1: time & date                                   | Data type G<br>Data type F or 6 byte<br>BCD coding              |
| E111 1000 | Fabrication No.        |   | 00000000 to<br>99999999   |
| E111 1010 | Bus address            |   | 0-250   |
| 1111 1011 | Extension of VIF-codes |   | Not used by the meter   |
| 1111 1101 | Extension of VIF-codes |   | True VIF is given in the first VIFE and is coded using Table FD |
| 1111 1111 | Manufacturer specific  |   | Next VIFE is manufacturer specific                              |

**10.2.2.2 Standard codes for VIFE used with extension indicator FDh**

If the VIF contains the extension indicator FDh the true VIF is contained in the first VIFE.

| VIFE-code | Description   |
|-----------|---|
| E000 1010 | Manufacturer  |
| E000 1100 | Version   |
| E000 1110 | Firmware Version  |
| E001 1010 | Digital Output (binary)   |
| E001 1011 | Digital Input (binary)  |
| E001 1100 | Baud rate   |
| E010 01nn | Interval length, 00: seconds, 01: minutes), 10: hours, 11: days |

| VIFE-code | Description           |
|-----------|-----------------------|
| E100 nnnn | $10^{(nnnn-9)}$ Volts |
| E101 nnnn | $10^{(nnnn-12)}$ A    |
| E110 0001 | Cumulating counter    |
| E001 0110 | Password              |

### 10.2.2.3 Standard codes for VIFE

The following values for VIFE's are defined for an enhancement of VIF's other than FDh and FBh:

| VIFE-code | Description   |
|-----------|---|
| E010 0111 | Per measurement (interval) <sup>1 2</sup>   |
| E011 1001 | Start date(/time) of  |
| E110 1f1b | Date (/time) of, b = 0: end of, b = 1: begin of, f is not used in meters, always 0 <sup>1 2</sup> |
| 1111 1111 | Next VIFE is manufacturer specific  |

1. Date (/time) of "or duration of" relates to the information which the whole data record contains.
2. The information about usage of data type F (date and time) or data type G (date) can be derived from the data field (0010b: type G/0100: type F).

### 10.2.2.4 First manufacturer specific VIFE-codes

| VIFE-code | Description        |
|-----------|--------------------|
| E000 0000 | Total              |
| E000 0001 | L1                 |
| E000 0010 | L2                 |
| E000 0011 | L3                 |
| E000 0100 | N                  |
| E000 0101 | L1-L2              |
| E000 0110 | L3-L2              |
| E000 0111 | L1-L3              |
| E001 0000 | Pulse frequency    |
| E001 0011 | Tariff             |
| E001 0100 | Installation check |
| E001 0101 | Status of values   |
| E001 0111 | Current quadrant   |
| E001 1000 | Power fail counter |

| VIFE-code | Description   |
|-----------|---|
| E010 0000 | Current Transformer (CT) ratio primary current  |
| E010 0001 | Voltage Transformer (VT) ratio primary voltage  |
| E010 0010 | Current Transformer (CT) ratio secondary current  |
| E010 0011 | Voltage Transformer (VT) ratio secondary voltage  |
| E010 0100 | CO2 conversion factor (kg * 10 <sup>-3</sup> /kWh)  |
| E010 0101 | Currency conversion factor (curr * 10 <sup>-3</sup> /kWh)   |
| E010 0110 | Error flags   |
| E010 0111 | Warning flags   |
| E010 1000 | Information flags   |
| E010 1001 | Alarm flags   |
| E010 1010 | Type designation (e.g. A43 552-100)   |
| E010 1011 | Sub interval  |
| E010 1101 | Number of elements  |
| E100 0nnn | Phase angle voltage (degrees *10 <sup>(nnn-3)</sup> )   |
| E100 1nnn | Phase angle current (degrees *10 <sup>(nnn-3)</sup> )   |
| E101 0nnn | Phase angle power (degrees *10 <sup>(nnn-3)</sup> )   |
| E101 1nnn | Frequency (Hz *10 <sup>(nnn-3)</sup> )  |
| E110 0nnn | Power factor (*10 <sup>(nnn-3)</sup> )  |
| E110 1010 | Change communication write access level   |
| E110 1100 | Power outage time   |
| E110 1101 | Current harmonics   |
| E110 1110 | Voltage harmonics   |
| E110 1111 | Event type  |
| E111 0000 | Measurement period  |
| E111 0001 | Reset counter for energy  |
| E111 0010 | Resettable register   |
| E111 1000 | Extension of manufacturer specific VIFE's, next VIFE(s) used for numbering                                  |
| E111 1001 | Extension of manufacturer specific VIFE's, next VIFE(s) specifies actual meaning                            |
| E111 1110 | Extension of manufacturer specific VIFE's, next VIFE(s) used for manufacturer specific record errors/status |

### 10.2.2.5 VIFE-Codes for reports of record errors (meter to master)

| VIFE-code | Type of record error                | Error group |
|-----------|-------------------------------------|-------------|
| E000 0000 | None                                |             |
| E001 0101 | No data available (undefined value) |             |
| E001 1000 | Data error                          | Data errors |

### 10.2.2.6 VIFE-Codes for object actions (master to meter)

| VIFE-code | Action      | Description                   |
|-----------|-------------|-------------------------------|
| E000 0111 | Clear       | Set data to zero              |
| E000 1011 | Freeze data | Freeze data to storage number |

### 10.2.2.7 2:nd manufacturer specific VIFE followed after VIFE 1111 1000 (F8 hex):

| VIFE-code | Description                |
|-----------|----------------------------|
| Ennn nnnn | Used for numbering (0-127) |

### 10.2.2.8 2:nd manufacturer specific VIFE followed after VIFE 1111 1001 (F9 hex):

| VIFE-code | Description   |
|-----------|---|
| E000 0010 | Quantity specification of maximum demand  |
| E000 0011 | Quantity specification of previous values   |
| E000 0100 | Quantity specification of load profile  |
| E000 0110 | Tariff source   |
| E000 1010 | DST, day of week, day type, season  |
| E000 1011 | Telegram set  |
| E001 0000 | Readout request of active imported energy load profile in format energy register values at end of intervals   |
| E001 0010 | Readout request of reactive imported energy load profile in format energy register values at end of intervals |
| E001 0100 | Readout request of input 1 counter load profile in format counter register values at end of intervals         |
| E001 0110 | Readout request of input 2 counter load profile in format counter register values at end of intervals         |
| E001 1000 | Readout request of maximum demand   |
| E001 1001 | Readout request of previous values  |
| E001 1011 | Readout request of current harmonics  |
| E001 1100 | Readout request of active exported energy load profile in format energy register values at end of intervals   |



| VIFE-code | Description   |
|-----------|---|
| E001 1110 | Readout request of reactive exported energy load profile in format energy register values at end of intervals |
| E010 0000 | Readout request of apparent imported energy load profile in format energy register values at end of intervals |
| E010 0010 | Readout request of apparent exported energy load profile in format energy register values at end of intervals |
| E010 0100 | Readout request of input 3 counter load profile in format counter register values at end of intervals         |
| E010 0110 | Readout request of input 4 counter load profile in format counter register values at end of intervals         |
| E010 1000 | Readout request of current load profile   |
| E010 1001 | Readout request of voltage load profile   |
| E010 1010 | Readout request of THD voltage load profile   |
| E010 1011 | Readout request of THD current load profile   |
| E010 1100 | Readout request of power factor load profile  |
| E010 1101 | Readout request of voltage harmonics  |
| E010 1110 | System log  |
| E011 0000 | Net quality log   |
| E011 0010 | Event log   |
| E011 0011 | Event type system log   |
| E011 0101 | Event type net quality log  |
| E011 0111 | Event type event log  |
| E011 1000 | Readout request of load profile based on channel number   |
| E100 0nnn | Energy in CO <sub>2</sub> (kg *10 <sup>nnn-7</sup> )  |
| E100 1nnn | Energy in currency (currency * 10 <sup>nnn-3</sup> )  |
| E101 snnn | Level nnn (binary coding), s=1 for sliding, 0 for non-sliding   |

**10.2.2.9 2:nd manufacturer specific VIFE followed after VIFE 1111 1110 (FE hex):**

| VIFE-code | Description  |
|-----------|--|
| E00t opsl | Data status for load profile, t=time change, o = overflow, p = power outage during interval, s = short interval, l = long interval |

**10.2.3 Communication process**

**General**

The Data Link Layer uses two kinds of transmission services:

|              |         |
|--------------|---------|
| Send/Confirm | SND/CON |
|--------------|---------|

|                 |         |
|-----------------|---------|
| Request/Respond | REQ/RSP |
|-----------------|---------|

When the meter has received a correct telegram it waits between 35 and 80 ms before it responds. A telegram is considered as correct if it passes the following tests:

- Start /Parity /Stop bits per character
- Start /Check Sum /Stop characters per telegram format
- In case of a long frame, the number of additional characters received match the L-field (= L Field + 6).
- If the received data is reasonable

The time between a response from the meter and a new message from the master must be at least 20 ms.

---

### Send/confirm procedure

**SND\_NKE** is used to initiate communication with the meter. When the meter has received an NKE followed by a REQ\_UD2 (see description below), the 1st telegram from the meter is sent out.

If the meter was selected for secondary addressing it will be deselected. The value of the FCB is cleared in the meter, i.e., the meter expects that the first telegram from a master with FCV=1 contains an FCB=1.

The meter can either confirm a correct reception with the single character acknowledge (E5h), or it can omit confirmation because it did not receive the telegram correctly.

**SND\_UD** is used to send data to the meter. The meter either confirms reception of a correct message or it omits confirmation because it did not receive the telegram correctly.

---

### Request/respond procedure

**REQ\_UD2** is used by the master to request data from the meter. **RSP\_UD** is used by the meter to transfer data to the master. The meter indicates to the master that more data will follow in the next telegram by sending 1Fh as the last user data.

If the meter does not respond to the REQ\_UD2, it's an indication that the message was not received correctly or that the address does not match.

---

10.2.3.1 Selection and secondary addressing

General

It is possible to communicate with the meter using secondary addressing. The secondary addressing takes place with the help of a selection:

|     |     |     |     |     |     |     |           |                          |                              |             |    |     |
|-----|-----|-----|-----|-----|-----|-----|-----------|--------------------------|------------------------------|-------------|----|-----|
| 68h | 0Bh | 0Bh | 68h | 53h | FDh | 52h | ID<br>1-4 | Manu-<br>facturer<br>1-2 | Gener-<br>ation <sup>1</sup> | Me-<br>dium | CS | 16h |
|-----|-----|-----|-----|-----|-----|-----|-----------|--------------------------|------------------------------|-------------|----|-----|

1. Generation means the same thing as version.

The master sends a SND\_UD with the control information 52h to the address 253 (FDh) and fills the specific meter secondary address fields (identification number, manufacturer, version and medium) with the values of the meter that is to be addressed. The address (FDh) and the control information (52h) is the indication for the meter to compare the following secondary address with its own, and to change into the selected state should it match. In this case the meter answers the selection with an acknowledgement (E5h), otherwise it does not reply. Selected state means that the meter can be addressed with the bus address 253 (FDh).

Wild cards

During selection individual positions of the secondary addresses can be occupied by wildcards. Such a wildcard means that this position will not be taken into account during selection. In the identification number each individual digit can be wild-carded by a wildcard nibble Fh while the fields for manufacturer, version and medium can be wild-carded by a wildcard byte FFh. The meter will remain selected until it receives a selection command with non-matching secondary addresses, a selection command with CI=56h, or a SND\_NKE to address 253.

### 10.3 Standard Readout of Meter Data

**General**

This section describes the readout of the default telegrams containing energy and instrumentation values etc. The data readout procedure starts when the master sends a REQ\_UD2 telegram to the meter. The meter responds with a RSP\_UD telegram. A typical readout is a multi-telegram readout. The last DIF in the user data part of the telegram is 1F to indicate that there is more data in the next telegram, or 0F if there are no more telegrams.

For EQ meters there are up to 7 default telegrams to read. In meters with internal clock more telegrams may follow, containing previous values data. The most recent values are sent out first having storage number 1, then the second most recently stored values with storage number 2 and so on until all stored previous values have been read. If no previous values exist in a meter with internal clock a telegram is sent out where all data is marked with status byte for "No data available".

It is also possible to read previous values starting from a specific date and backwards in time by sending a special read request.



**Note – Note:** Normally the meter is configured to send out power values as 32 bit integers, expressed in W (or var/VA) with 2 decimals. This means that the maximum power possible to express is approximately  $\pm 21$  MW

Below following sections is an example of a readout of the 7 default telegrams and 2 previous values telegrams, containing the most recent snapshot of previous values. Note that these are examples only, data types and scaling of the quantities can differ between meters, as well as the allocation of quantities to different telegrams.

#### 10.3.1 Example of the 1st telegram (all values are hexadecimal)

| Byte No. | Size | Value   | Description  |
|----------|------|---------|--|
| 1        | 1    | 68      | Start character                                    |
| 2        | 1    | FA      | L-field, calculated from C field to last user data |
| 3        | 1    | FA      | L-field, repeated                                  |
| 4        | 1    | 68      | Start character                                    |
| 5        | 1    | 08      | C-field, RSP_UD                                    |
| 6        | 1    | xx      | A-field, address                                   |
| 7        | 1    | 72      | CI-field, variable data respond, LSB first         |
| 8-11     | 4    | xxxxxxx | Identification Number, 8 BCD digits                |
| 12-13    | 2    | 4204    | Manufacturer: ABB                                  |
| 14       | 1    | 02      | Version  |
| 15       | 1    | 02      | Medium, 02 = Electricity                           |
| 16       | 1    | xx      | Number of accesses                                 |
| 17       | 1    | xx      | Status   |
| 18-19    | 2    | 0000    | Signature (0000 = no encryption)                   |

| Byte No. | Size | Value       | Description                               |
|----------|------|-------------|---|
| 20       | 1    | 0E          | DIF size, 12 digit BCD                    |
| 21       | 1    | 84          | VIF for units kWh with resolution 0,01kWh |
| 22       | 1    | xx          | VIFE status                               |
| 23-28    | 6    | xxxxxxxxxxx | Active imported energy, Total             |
| 29       | 1    | 8E          | DIF size, 12 digit BCD                    |
| 30       | 1    | 10          | DIFE, tariff 1                            |
| 31       | 1    | 84          | VIF for units kWh with resolution 0,01kWh |
| 32       | 1    | xx          | VIFE status                               |
| 33-38    | 6    | xxxxxxxxxxx | Active imported energy, Tariff 1          |
| 39       | 1    | 8E          | DIF size, 12 digit BCD                    |
| 40       | 1    | 20          | DIFE, tariff 2                            |
| 41       | 1    | 84          | VIF for units kWh with resolution 0,01kWh |
| 42       | 1    | xx          | VIFE status                               |
| 43-48    | 6    | xxxxxxxxxxx | Active imported energy, Tariff 2          |
| 49       | 1    | 8E          | DIF size, 12 digit BCD                    |
| 50       | 1    | 30          | DIFE, tariff 3                            |
| 51       | 1    | 84          | VIF for units kWh with resolution 0,01kWh |
| 52       | 1    | xx          | VIFE status                               |
| 53-58    | 6    | xxxxxxxxxxx | Active imported energy, Tariff 3          |
| 59       | 1    | 8E          | DIF size, 12 digit BCD                    |
| 60       | 1    | 80          | DIFE,                                     |
| 61       | 1    | 10          | DIFE, tariff 4                            |
| 62       | 1    | 84          | VIF for units kWh with resolution 0,01kWh |
| 63       | 1    | xx          | VIFE status                               |
| 64-69    | 6    | xxxxxxxxxxx | Active imported energy, Tariff 4          |
| 70       | 1    | 8E          | DIF size, 12 digit BCD                    |
| 71       | 1    | 40          | DIFE, unit 1                              |
| 72       | 1    | 84          | VIF for units kWh with resolution 0,01kWh |
| 73       | 1    | xx          | VIFE status                               |
| 74-79    | 6    | xxxxxxxxxxx | Active exported energy, Total             |
| 80       | 1    | 8E          | DIF size, 12 digit BCD                    |
| 81       | 1    | 50          | DIFE, tariff 1, unit 1                    |
| 82       | 1    | 84          | VIF for units kWh with resolution 0,01kWh |
| 83       | 1    | xx          | VIFE status                               |
| 84-89    | 6    | xxxxxxxxxxx | Active exported energy, Tariff 1          |
| 90       | 1    | 8E          | DIF size, 12 digit BCD                    |
| 91       | 1    | 60          | DIFE, tariff 2, unit 1                    |
| 92       | 1    | 84          | VIF for units kWh with resolution 0,01kWh |
| 93       | 1    | xx          | VIFE status                               |
| 94-99    | 6    | xxxxxxxxxxx | Active exported energy, Tariff 2          |
| 100      | 1    | 8E          | DIF size, 12 digit BCD                    |

| Byte No. | Size | Value            | Description                                 |
|----------|------|------------------|---|
| 101      | 1    | 70               | DIFE, tariff 3, unit 1                      |
| 102      | 1    | 84               | VIF for units kWh with resolution 0,01kWh   |
| 103      | 1    | xx               | VIFE status                                 |
| 104-109  | 6    | xxxxxxxxxxx      | Active exported energy, Tariff 3            |
| 110      | 1    | 8E               | DIF size, 12 digit BCD                      |
| 111      | 1    | C0               | DIFE, unit 1                                |
| 112      | 1    | 10               | DIFE, tariff 4                              |
| 113      | 1    | 84               | VIF for units kWh with resolution 0,01kWh   |
| 114      | 1    | xx               | VIFE status                                 |
| 115-120  | 6    | xxxxxxxxxxx      | Active exported energy, Tariff 4            |
| 121      | 1    | 01               | DIF size, 8 bit integer                     |
| 122      | 1    | FF               | VIF next byte is manufacturer specific      |
| 123      | 1    | 93               | VIFE current tariff                         |
| 124      | 1    | xx               | VIFE status                                 |
| 125      | 1    | xx               | Current tariff                              |
| 126      | 1    | 04               | DIF size, 32 bit integer                    |
| 127      | 1    | FF               | VIF next byte is manufacturer specific      |
| 128      | 1    | A0               | VIFE CT ratio primary current               |
| 129      | 1    | xx               | VIFE status                                 |
| 130-133  | 4    | xxxxxxx          | Current transformer ratio primary current   |
| 134      | 1    | 04               | DIF size, 32 bit integer                    |
| 135      | 1    | FF               | VIF next byte is manufacturer specific      |
| 136      | 1    | A1               | VIFE VT ratio primary voltage               |
| 137      | 1    | xx               | VIFE status                                 |
| 138-141  | 4    | xxxxxxx          | Voltage transformer ratio primary voltage   |
| 142      | 1    | 04               | DIF size, 32 bit integer                    |
| 143      | 1    | FF               | VIF next byte is manufacturer specific      |
| 144      | 1    | A2               | VIFE CT ratio secondary current             |
| 145      | 1    | xx               | VIFE status                                 |
| 146-149  | 4    | xxxxxxx          | Current transformer ratio secondary current |
| 150      | 1    | 04               | DIF size, 32 bit integer                    |
| 151      | 1    | FF               | VIF next byte is manufacturer specific      |
| 152      | 1    | A3               | VIFE VT ratio secondary voltage             |
| 153      | 1    | xx               | VIFE status                                 |
| 154-157  | 4    | xxxxxxx          | Voltage transformer ratio secondary voltage |
| 158      | 1    | 07               | DIF size, 64 bit integer                    |
| 159      | 1    | FF               | VIF next byte is manufacturer specific      |
| 160      | 1    | A6               | VIFE error flags (binary)                   |
| 161      | 1    | xx               | VIFE status                                 |
| 162-169  | 8    | xxxxxxxxxxxxxxxx | 64 Error flags                              |
| 170      | 1    | 07               | DIF size, 64 bit integer                    |

| Byte No. | Size | Value                       | Description   |
|----------|------|-----------------------------|---|
| 171      | 1    | FF                          | VIF next byte is manufacturer specific  |
| 172      | 1    | A7                          | VIFE warning flags (binary)   |
| 173      | 1    | xx                          | VIFE status   |
| 174-181  | 8    | xxxxxxxxxxxxxxxx            | 64 Warning flags  |
| 182      | 1    | 07                          | DIF size, 64 bit integer  |
| 183      | 1    | FF                          | VIF next byte is manufacturer specific  |
| 184      | 1    | A8                          | VIFE information flags (binary)   |
| 185      | 1    | xx                          | VIFE status   |
| 186-193  | 8    | xxxxxxxxxxxxxxxx            | 64 Information flags  |
| 194      | 1    | 07                          | DIF size, 64 bit integer  |
| 195      | 1    | FF                          | VIF next byte is manufacturer specific  |
| 196      | 1    | A9                          | VIFE alarm flags (binary)   |
| 197      | 1    | xx                          | VIFE status   |
| 198-205  | 8    | xxxxxxxxxxxxxxxx            | 64 Alarm flags  |
| 206      | 1    | 0E                          | DIF size, 12 digit BCD  |
| 207      | 1    | ED                          | VIF time/date   |
| 208      | 1    | xx                          | VIFE status   |
| 209-214  | 6    | xxxxxxx                     | Time and date (sec,min,hour,day,month,year)   |
| 215      | 1    | 02                          | DIF size, 16 bit integer  |
| 216      | 1    | FF                          | VIF next byte is manufacturer specific  |
| 217      | 1    | F9                          | VIF extension of manufacturer specific VIFE's, next VIFE specifies actual meaning   |
| 218      | 1    | 8A                          | VIFE DST, day of week, day type, season   |
| 219      | 1    | xx                          | VIFE status   |
| 220-221  | 2    | xxxx                        | DST data in bit 0: 1:DST active, 0:DST inactive<br>Day of week data in bit 4-6: 001-111; Monday-Sunday<br>Active day type in bit 8-11: 0000-1111; Type of day 1-16<br>Season data in bit 12-13: 00-11; Season 1-4 |
| 222      | 1    | 0D                          | DIF size, variable length, ASCII coding   |
| 223      | 1    | FD                          | VIF extension of VIF-codes  |
| 224      | 1    | 8E                          | VIFE Firmware   |
| 225      | 1    | xx                          | VIFE status   |
| 226      | 1    | 0C                          | Byte specifying length of following ASCII string, see below   |
| 227-238  | 12   | xxxxxxxxxxxxxxxx<br>xxxxxxx | Firmware version (ASCII coded, LSB byte first), containing of a character followed by three or four numbers (0-255) separated by periods, for example A1.13.0. Length can be 6-16 bytes                           |
| 239      | 1    | 0D                          | DIF size, variable length, ASCII coding   |
| 240      | 1    | FF                          | VIF next byte is manufacturer specific  |
| 241      | 1    | AA                          | VIFE Type designation   |
| 242      | 1    | xx                          | VIFE status   |
| 243      | 1    | 0B                          | Byte specifying length  |

| Byte No. | Size | Value                       | Description  |
|----------|------|-----------------------------|--|
| 244-254  | 11   | xxxxxxxxxxxxxxxxxx<br>xxxxx | Type designation (ASCII coded, LSB byte first), for example: A44 552-100 |
| 255      | 1    | 1F                          | DIF, more records will follow in next telegram                           |
| 255      | 1    | xx                          | CS checksum, calculated from C field to last data                        |
| 256      | 1    | 16                          | Stop character   |

### 10.3.2 Example of 2nd telegram (all values are hexadecimal)

| Byte No. | Size | Value   | Description  |
|----------|------|---------|--|
| 1        | 1    | 68      | Start character                                    |
| 2        | 1    | FC      | L-field, calculated from C field to last user data |
| 3        | 1    | FC      | L-field, repeated                                  |
| 4        | 1    | 68      | Start character                                    |
| 5        | 1    | 08      | C-field, RSP_UD                                    |
| 6        | 1    | xx      | A-field, address                                   |
| 7        | 1    | 72      | CI-field, variable data respond, LSB first         |
| 8-11     | 4    | xxxxxxx | Identification Number, 8 BCD digits                |
| 12-13    | 2    | 4204    | Manufacturer: ABB                                  |
| 14       | 1    | 02      | Version  |
| 15       | 1    | 02      | Medium, 02 = Electricity                           |
| 16       | 1    | xx      | Number of accesses                                 |
| 17       | 1    | xx      | Status   |
| 18-19    | 2    | 0000    | Signature (0000 = no encryption)                   |
| 20       | 1    | 04      | DIF size, 32 bit integer                           |
| 21       | 1    | FF      | VIF next byte is manufacturer specific             |
| 22       | 1    | 98      | VIFE Power fail counter                            |
| 23       | 1    | xx      | VIFE status  |
| 24-27    | 4    | xxxxxxx | Power fail counter                                 |
| 28       | 1    | 04      | DIF size, 32 bit integer                           |
| 29       | 1    | A9      | VIF for units W with resolution 0,01W              |
| 30       | 1    | xx      | VIFE status  |
| 31-34    | 4    | xxxxxxx | Active power, Total                                |
| 35       | 1    | 04      | DIF size, 32 bit integer                           |
| 36       | 1    | A9      | VIF for units W with resolution 0,01W              |
| 37       | 1    | FF      | VIFE next byte is manufacturer specific            |
| 38       | 1    | 81      | VIFE L1  |
| 39       | 1    | xx      | VIFE status  |
| 40-43    | 4    | xxxxxxx | Active power, L1                                   |
| 44       | 1    | 04      | DIF size, 32 bit integer                           |
| 45       | 1    | A9      | VIF for units W with resolution 0,01W              |
| 46       | 1    | FF      | VIFE next byte is manufacturer specific            |
| 47       | 1    | 82      | VIFE L2  |



| Byte No. | Size | Value   | Description                               |
|----------|------|---------|---|
| 48       | 1    | xx      | VIFE status                               |
| 49-52    | 4    | xxxxxxx | Active power, L2                          |
| 53       | 1    | 04      | DIF size, 32 bit integer                  |
| 54       | 1    | A9      | VIF for units W with resolution 0,01W     |
| 55       | 1    | FF      | VIFE next byte is manufacturer specific   |
| 56       | 1    | 83      | VIFE L3                                   |
| 57       | 1    | xx      | VIFE status                               |
| 58-61    | 4    | xxxxxxx | Active power, L3                          |
| 62       | 1    | 84      | DIF size, 32 bit integer                  |
| 63       | 1    | 80      | DIFE (Unit = 0)                           |
| 64       | 1    | 40      | DIFE (Unit = 1, => xx10 (2))              |
| 65       | 1    | A9      | VIF for units var with resolution 0,01var |
| 66       | 1    | xx      | VIFE status                               |
| 67-70    | 4    | xxxxxxx | Reactive power, Total                     |
| 71       | 1    | 84      | DIF size, 32 bit integer                  |
| 72       | 1    | 80      | DIFE (Unit = 0)                           |
| 73       | 1    | 40      | DIFE (Unit = 1, => xx10 (2))              |
| 74       | 1    | A9      | VIF for units var with resolution 0,01var |
| 75       | 1    | FF      | VIFE next byte is manufacturer specific   |
| 76       | 1    | 81      | VIFE L1                                   |
| 77       | 1    | xx      | VIFE status                               |
| 78-81    | 4    | xxxxxxx | Reactive power, L1                        |
| 82       | 1    | 84      | DIF size, 32 bit integer                  |
| 83       | 1    | 80      | DIFE (Unit = 0)                           |
| 84       | 1    | 40      | DIFE (Unit = 1, => xx10 (2))              |
| 85       | 1    | A9      | VIF for units var with resolution 0,01var |
| 86       | 1    | FF      | VIFE next byte is manufacturer specific   |
| 87       | 1    | 82      | VIFE L2                                   |
| 88       | 1    | xx      | VIFE status                               |
| 89-92    | 4    | xxxxxxx | Reactive power, L2                        |
| 93       | 1    | 84      | DIF size, 32 bit integer                  |
| 94       | 1    | 80      | DIFE (Unit = 0)                           |
| 95       | 1    | 40      | DIFE (Unit = 1, => xx10 (2))              |
| 96       | 1    | A9      | VIF for units var with resolution 0,01var |
| 97       | 1    | FF      | VIFE next byte is manufacturer specific   |
| 98       | 1    | 83      | VIFE L3                                   |
| 99       | 1    | xx      | VIFE status                               |
| 100-103  | 4    | xxxxxxx | Reactive power, L3                        |
| 104      | 1    | 84      | DIF size, 32 bit integer                  |
| 105      | 1    | 80      | DIFE (Unit = 0)                           |
| 106      | 1    | 80      | DIFE (Unit = 0)                           |

| Byte No. | Size | Value   | Description                             |
|----------|------|---------|---|
| 107      | 1    | 40      | DIFE (Unit = 1, => x100 (4))            |
| 108      | 1    | A9      | VIF for units VA with resolution 0,01VA |
| 109      | 1    | xx      | VIFE status                             |
| 110-113  | 4    | xxxxxxx | Apparent power, Total                   |
| 114      | 1    | 84      | DIF size, 32 bit integer                |
| 115      | 1    | 80      | DIFE (Unit = 0)                         |
| 116      | 1    | 80      | DIFE (Unit = 0)                         |
| 117      | 1    | 40      | DIFE (Unit = 1, => x100 (4))            |
| 118      | 1    | A9      | VIF for units VA with resolution 0,01VA |
| 119      | 1    | FF      | VIFE next byte is manufacturer specific |
| 120      | 1    | 81      | VIFE L1                                 |
| 121      | 1    | xx      | VIFE status                             |
| 122-125  | 4    | xxxxxxx | Apparent power, L1                      |
| 126      | 1    | 84      | DIF size, 32 bit integer                |
| 127      | 1    | 80      | DIFE (Unit = 0)                         |
| 128      | 1    | 80      | DIFE (Unit = 0)                         |
| 129      | 1    | 40      | DIFE (Unit = 1, => x100 (4))            |
| 130      | 1    | A9      | VIF for units VA with resolution 0,01VA |
| 131      | 1    | FF      | VIFE next byte is manufacturer specific |
| 132      | 1    | 82      | VIFE L2                                 |
| 133      | 1    | xx      | VIFE status                             |
| 134-137  | 4    | xxxxxxx | Apparent power, L2                      |
| 138      | 1    | 84      | DIF size, 32 bit integer                |
| 139      | 1    | 80      | DIFE (Unit = 0)                         |
| 140      | 1    | 80      | DIFE (Unit = 0)                         |
| 141      | 1    | 40      | DIFE (Unit = 1, => x100 (4))            |
| 142      | 1    | A9      | VIF for units VA with resolution 0,01VA |
| 143      | 1    | FF      | VIFE next byte is manufacturer specific |
| 144      | 1    | 83      | VIFE L3                                 |
| 145      | 1    | xx      | VIFE status                             |
| 146-149  | 4    | xxxxxxx | Apparent power, L3                      |
| 150      | 1    | 04      | DIF size, 32 bit integer                |
| 151      | 1    | FD      | VIF extension of VIF-codes              |
| 152      | 1    | C8      | VIFE for units V with resolution 0,1V   |
| 153      | 1    | FF      | VIFE next byte is manufacturer specific |
| 154      | 1    | 81      | VIFE L1                                 |
| 155      | 1    | xx      | VIFE status                             |
| 156-159  | 4    | xxxxxxx | Voltage L1 - N                          |
| 160      | 1    | 04      | DIF size, 32 bit integer                |
| 161      | 1    | FD      | VIF extension of VIF-codes              |
| 162      | 1    | C8      | VIFE for units V with resolution 0,1V   |

| Byte No. | Size | Value   | Description                             |
|----------|------|---------|---|
| 163      | 1    | FF      | VIFE next byte is manufacturer specific |
| 164      | 1    | 82      | VIFE L2                                 |
| 165      | 1    | xx      | VIFE status                             |
| 166-169  | 4    | xxxxxxx | Voltage L2 - N                          |
| 170      | 1    | 04      | DIF size, 32 bit integer                |
| 171      | 1    | FD      | VIF extension of VIF-codes              |
| 172      | 1    | C8      | VIFE for units V with resolution 0,1V   |
| 173      | 1    | FF      | VIFE next byte is manufacturer specific |
| 174      | 1    | 83      | VIFE L3                                 |
| 175      | 1    | xx      | VIFE status                             |
| 176-179  | 4    | xxxxxxx | Voltage L3 - N                          |
| 180      | 1    | 04      | DIF size, 32 bit integer                |
| 181      | 1    | FD      | VIF extension of VIF-codes              |
| 182      | 1    | C8      | VIFE for units V with resolution 0,1V   |
| 183      | 1    | FF      | VIFE next byte is manufacturer specific |
| 184      | 1    | 85      | VIFE L1 - L2                            |
| 185      | 1    | xx      | VIFE status                             |
| 186-189  | 4    | xxxxxxx | Voltage L1 - L2                         |
| 190      | 1    | 04      | DIF size, 32 bit integer                |
| 191      | 1    | FD      | VIF extension of VIF-codes              |
| 192      | 1    | C8      | VIFE for units V with resolution 0,1V   |
| 193      | 1    | FF      | VIFE next byte is manufacturer specific |
| 194      | 1    | 86      | VIFE L2 - L3                            |
| 195      | 1    | xx      | VIFE status                             |
| 196-199  | 4    | xxxxxxx | Voltage L3 - L2                         |
| 200      | 1    | 04      | DIF size, 32 bit integer                |
| 201      | 1    | FD      | VIF extension of VIF-codes              |
| 202      | 1    | C8      | VIFE for units V with resolution 0,1V   |
| 203      | 1    | FF      | VIFE next byte is manufacturer specific |
| 204      | 1    | 87      | VIFE L1 - L3                            |
| 205      | 1    | xx      | VIFE status                             |
| 206-209  | 4    | xxxxxxx | Voltage L1 - L3                         |
| 210      | 1    | 04      | DIF size, 32 bit integer                |
| 211      | 1    | FD      | VIF extension of VIF-codes              |
| 212      | 1    | DA      | VIFE for units A with resolution 0,01A  |
| 213      | 1    | FF      | VIFE next byte is manufacturer specific |
| 214      | 1    | 81      | VIFE L1                                 |
| 215      | 1    | xx      | VIFE status                             |
| 216-219  | 4    | xxxxxxx | Current L1                              |
| 220      | 1    | 04      | DIF size, 32 bit integer                |
| 221      | 1    | FD      | VIF extension of VIF-codes              |

| Byte No. | Size | Value   | Description                                       |
|----------|------|---------|---|
| 222      | 1    | DA      | VIFE for units A with resolution 0,01A            |
| 223      | 1    | FF      | VIFE next byte is manufacturer specific           |
| 224      | 1    | 82      | VIFE L2   |
| 225      | 1    | xx      | VIFE status                                       |
| 226-229  | 4    | xxxxxxx | Current L2  |
| 230      | 1    | 04      | DIF size, 32 bit integer                          |
| 231      | 1    | FD      | VIF extension of VIF-codes                        |
| 232      | 1    | DA      | VIFE for units A with resolution 0,01A            |
| 233      | 1    | FF      | VIFE next byte is manufacturer specific           |
| 234      | 1    | 83      | VIFE L3   |
| 235      | 1    | xx      | VIFE status                                       |
| 236-239  | 4    | xxxxxxx | Current L3  |
| 240      | 1    | 04      | DIF size, 32 bit integer                          |
| 241      | 1    | FD      | VIF extension of VIF-codes                        |
| 242      | 1    | DA      | VIFE for units A with resolution 0,01A            |
| 243      | 1    | FF      | VIFE next byte is manufacturer specific           |
| 244      | 1    | 84      | VIFE N  |
| 245      | 1    | xx      | VIFE status                                       |
| 246-249  | 4    | xxxxxxx | Current N   |
| 250      | 1    | 0A      | DIF size, 4 digit BCD                             |
| 251      | 1    | FF      | VIF next byte is manufacturer specific            |
| 252      | 1    | E9      | VIFE Frequency with resolution 0.01Hz             |
| 253      | 1    | xx      | VIFE status                                       |
| 254-255  | 2    | xxxx    | Frequency   |
| 256      | 1    | 1F      | DIF more records will follow in next telegram     |
| 257      | 1    | xx      | CS checksum, calculated from C field to last data |
| 258      | 1    | 16      | Stop character                                    |

### 10.3.3 Example of 3rd telegram (all values are hexadecimal)

| Byte No. | Size | Value   | Description  |
|----------|------|---------|--|
| 1        | 1    | 68      | Start character                                    |
| 2        | 1    | F4      | L-field, calculated from C field to last user data |
| 3        | 1    | F4      | L-field, repeated                                  |
| 4        | 1    | 68      | Start character                                    |
| 5        | 1    | 08      | C-field, RSP_UD                                    |
| 6        | 1    | xx      | A-field, address                                   |
| 7        | 1    | 72      | CI-field, variable data respond, LSB first         |
| 8-11     | 4    | xxxxxxx | Identification Number, 8 BCD digits                |
| 12-13    | 2    | 4204    | Manufacturer: ABB                                  |
| 14       | 1    | 02      | Version  |
| 15       | 1    | 02      | Medium, 02 = Electricity                           |

| Byte No. | Size | Value       | Description   |
|----------|------|-------------|---|
| 16       | 1    | xx          | Number of accesses                                  |
| 17       | 1    | xx          | Status  |
| 18-19    | 2    | 0000        | Signature (0000 = no encryption)                    |
| 20       | 1    | 0E          | DIF size, 12 digit BCD                              |
| 21       | 1    | FF          | VIF next byte is manufacturer specific              |
| 22       | 1    | EC          | VIFE Power outage time                              |
| 23       | 1    | xx          | VIFE status   |
| 24-29    | 6    | xxxxxxxxxxx | Power outage time (sec, min, hour, days, LSB first) |
| 30       | 1    | 02          | DIF size, 16 bit integer                            |
| 31       | 1    | FF          | VIF next byte is manufacturer specific              |
| 32       | 1    | E0          | VIFE power factor with resolution 0,001             |
| 33       | 1    | xx          | VIFE status   |
| 34-35    | 2    | xxxx        | Power factor, Total                                 |
| 36       | 1    | 02          | DIF size, 16 bit integer                            |
| 37       | 1    | FF          | VIF next byte is manufacturer specific              |
| 38       | 1    | E0          | VIFE power factor with resolution 0,001             |
| 39       | 1    | FF          | VIFE next byte is manufacturer specific             |
| 40       | 1    | 81          | VIFE L1   |
| 41       | 1    | xx          | VIFE status   |
| 42-43    | 2    | xxxx        | Power factor, L1                                    |
| 44       | 1    | 02          | DIF size, 16 bit integer                            |
| 45       | 1    | FF          | VIF next byte is manufacturer specific              |
| 46       | 1    | E0          | VIFE power factor with resolution 0,001             |
| 47       | 1    | FF          | VIFE next byte is manufacturer specific             |
| 48       | 1    | 82          | VIFE L2   |
| 49       | 1    | xx          | VIFE status   |
| 50-51    | 2    | xxxx        | Power factor, L2                                    |
| 52       | 1    | 02          | DIF size, 16 bit integer                            |
| 53       | 1    | FF          | VIF next byte is manufacturer specific              |
| 54       | 1    | E0          | VIFE power factor with resolution 0,001             |
| 55       | 1    | FF          | VIFE next byte is manufacturer specific             |
| 56       | 1    | 83          | VIFE L3   |
| 57       | 1    | xx          | VIFE status   |
| 58-59    | 2    | xxxx        | Power factor, L3                                    |
| 60       | 1    | 02          | DIF size, 16 bit integer                            |
| 61       | 1    | FF          | VIF next byte is manufacturer specific              |
| 62       | 1    | D2          | VIFE phase angle power with resolution 0.1          |
| 63       | 1    | xx          | VIFE status   |
| 64-65    | 2    | xxxx        | Phase angle power, Total                            |
| 66       | 1    | 02          | DIF size, 16 bit integer                            |
| 67       | 1    | FF          | VIF next byte is manufacturer specific              |

| Byte No. | Size | Value | Description                                  |
|----------|------|-------|--|
| 68       | 1    | D2    | VIFE phase angle power with resolution 0.1   |
| 69       | 1    | FF    | VIFE next byte is manufacturer specific      |
| 70       | 1    | 81    | VIFE L1                                      |
| 71       | 1    | xx    | VIFE status                                  |
| 72-73    | 2    | xxxx  | Phase angle power, L1                        |
| 74       | 1    | 02    | DIF size, 16 bit integer                     |
| 75       | 1    | FF    | VIF next byte is manufacturer specific       |
| 76       | 1    | D2    | VIFE phase angle power with resolution 0.1   |
| 77       | 1    | FF    | VIFE next byte is manufacturer specific      |
| 78       | 1    | 82    | VIFE L2                                      |
| 79       | 1    | xx    | VIFE status                                  |
| 80-81    | 2    | xxxx  | Phase angle power, L2                        |
| 82       | 1    | 02    | DIF size, 16 bit integer                     |
| 83       | 1    | FF    | VIF next byte is manufacturer specific       |
| 84       | 1    | D2    | VIFE phase angle power with resolution 0.1   |
| 85       | 1    | FF    | VIFE next byte is manufacturer specific      |
| 86       | 1    | 83    | VIFE L3                                      |
| 87       | 1    | xx    | VIFE status                                  |
| 88-89    | 2    | xxxx  | Phase angle power, L3                        |
| 90       | 1    | 02    | DIF size, 16 bit integer                     |
| 91       | 1    | FF    | VIF next byte is manufacturer specific       |
| 92       | 1    | C2    | VIFE phase angle voltage with resolution 0.1 |
| 93       | 1    | FF    | VIFE next byte is manufacturer specific      |
| 94       | 1    | 81    | VIFE L1                                      |
| 95       | 1    | xx    | VIFE status                                  |
| 96-97    | 2    | xxxx  | Phase angle voltage, L1                      |
| 98       | 1    | 02    | DIF size, 16 bit integer                     |
| 99       | 1    | FF    | VIF next byte is manufacturer specific       |
| 100      | 1    | C2    | VIFE phase angle voltage with resolution 0.1 |
| 101      | 1    | FF    | VIFE next byte is manufacturer specific      |
| 102      | 1    | 82    | VIFE L2                                      |
| 103      | 1    | xx    | VIFE status                                  |
| 104-105  | 2    | xxxx  | Phase angle voltage, L2                      |
| 106      | 1    | 02    | DIF size, 16 bit integer                     |
| 107      | 1    | FF    | VIF next byte is manufacturer specific       |
| 108      | 1    | C2    | VIFE phase angle voltage with resolution 0.1 |
| 109      | 1    | FF    | VIFE next byte is manufacturer specific      |
| 110      | 1    | 83    | VIFE L3                                      |
| 111      | 1    | xx    | VIFE status                                  |
| 112-113  | 2    | xxxx  | Phase angle voltage, L3                      |
| 114      | 1    | 02    | DIF size, 16 bit integer                     |

| Byte No. | Size | Value        | Description                                   |
|----------|------|--------------|---|
| 115      | 1    | FF           | VIF next byte is manufacturer specific        |
| 116      | 1    | CA           | VIFE phase angle current with resolution 0.1  |
| 117      | 1    | FA           | VIFE next byte is manufacturer specific       |
| 118      | 1    | 81           | VIFE L1                                       |
| 119      | 1    | xx           | VIFE status                                   |
| 120-121  | 2    | xxxx         | Phase angle current, L1                       |
| 122      | 1    | 02           | DIF size, 16 bit integer                      |
| 123      | 1    | FF           | VIF next byte is manufacturer specific        |
| 124      | 1    | CA           | VIFE phase angle current with resolution 0.1  |
| 125      | 1    | FF           | VIFE next byte is manufacturer specific       |
| 126      | 1    | 82           | VIFE L2                                       |
| 127      | 1    | xx           | VIFE status                                   |
| 128-129  | 2    | xxxx         | Phase angle current, L2                       |
| 130      | 1    | 02           | DIF size, 16 bit integer                      |
| 131      | 1    | FF           | VIF next byte is manufacturer specific        |
| 132      | 1    | CA           | VIFE phase angle current with resolution 0.1  |
| 133      | 1    | FF           | VIFE next byte is manufacturer specific       |
| 134      | 1    | 83           | VIFE L3                                       |
| 135      | 1    | xx           | VIFE status                                   |
| 136-137  | 2    | xxxx         | Phase angle current, L3                       |
| 138      | 1    | 8E           | DIF size, 12 digit BCD                        |
| 139      | 1    | 80           | DIFE,   |
| 140      | 1    | 40           | DIFE, unit 2                                  |
| 141      | 1    | 84           | VIF for units kvarh with resolution 0,01kvarh |
| 142      | 1    | xx           | VIFE status                                   |
| 143-148  | 6    | xxxxxxxxxxxx | Reactive imported energy, Total               |
| 149      | 1    | 8E           | DIF size, 12 digit BCD                        |
| 150      | 1    | 90           | DIFE, tariff 1                                |
| 151      | 1    | 40           | DIFE, unit 2                                  |
| 152      | 1    | 84           | VIF for units kvarh with resolution 0,01kvarh |
| 153      | 1    | xx           | VIFE status                                   |
| 154-159  | 6    | xxxxxxxxxxxx | Reactive imported energy, Tariff 1            |
| 160      | 1    | 8E           | DIF size, 12 digit BCD                        |
| 161      | 1    | A0           | DIFE, tariff 2                                |
| 162      | 1    | 40           | DIFE, unit 2                                  |
| 163      | 1    | 84           | VIF for units kvarh with resolution 0,01kvarh |
| 164      | 1    | xx           | VIFE status                                   |
| 165-170  | 6    | xxxxxxxxxxxx | Reactive imported energy, Tariff 2            |
| 171      | 1    | 8E           | DIF size, 12 digit BCD                        |
| 172      | 1    | B0           | DIFE, tariff 3                                |
| 173      | 1    | 40           | DIFE, unit 2                                  |

| Byte No. | Size | Value        | Description                                       |
|----------|------|--------------|---|
| 174      | 1    | 84           | VIF for units kvarh with resolution 0,01kvarh     |
| 175      | 1    | xx           | VIFE status                                       |
| 176-181  | 6    | xxxxxxxxxxxx | Reactive imported energy, Tariff 3                |
| 182      | 1    | 8E           | DIF size, 12 digit BCD                            |
| 183      | 1    | 80           | DIFE,   |
| 184      | 1    | 50           | DIFE, tariff 4, unit 2                            |
| 185      | 1    | 84           | VIF for units kvarh with resolution 0,01kvarh     |
| 186      | 1    | xx           | VIFE status                                       |
| 187-192  | 6    | xxxxxxxxxxxx | Reactive imported energy, Tariff 4                |
| 193      | 1    | 8E           | DIF size, 12 digit BCD                            |
| 194      | 1    | C0           | DIFE, unit bit 0                                  |
| 195      | 1    | 40           | DIFE, unit bit 1, unit bit0-1-> unit 3            |
| 196      | 1    | 84           | VIF for units kvarh with resolution 0,01kvarh     |
| 197      | 1    | xx           | VIFE status                                       |
| 198-203  | 6    | xxxxxxxxxxxx | Reactive exported energy, Total                   |
| 204      | 1    | 8E           | DIF size, 12 digit BCD                            |
| 205      | 1    | D0           | DIFE, tariff 1, unit bit 0                        |
| 206      | 1    | 40           | DIFE, unit bit 1, unit bit 0-1-> unit 3           |
| 207      | 1    | 84           | VIF for units kvarh with resolution 0,01kvarh     |
| 208      | 1    | xx           | VIFE status                                       |
| 209-214  | 6    | xxxxxxxxxxxx | Reactive exported energy, Tariff 1                |
| 215      | 1    | 8E           | DIF size, 12 digit BCD                            |
| 216      | 1    | E0           | DIFE, tariff 2, unit bit 0                        |
| 217      | 1    | 40           | DIFE, unit bit 1, unit bit 0-1-> unit 3           |
| 218      | 1    | 84           | VIF for units kvarh with resolution 0,01kvarh     |
| 219      | 1    | xx           | VIFE status                                       |
| 220-225  | 6    | xxxxxxxxxxxx | Reactive exported energy, Tariff 2                |
| 226      | 1    | 8E           | DIF size, 12 digit BCD                            |
| 227      | 1    | F0           | DIFE, tariff 3, unit bit 0                        |
| 228      | 1    | 40           | DIFE, unit bit 1, unit bit 0-1-> unit 3           |
| 229      | 1    | 84           | VIF for units kvarh with resolution 0,01kvarh     |
| 230      | 1    | xx           | VIFE status                                       |
| 231-236  | 6    | xxxxxxxxxxxx | Reactive exported energy, Tariff 3                |
| 237      | 1    | 8E           | DIF size, 12 digit BCD                            |
| 238      | 1    | C0           | DIFE, unit bit 0                                  |
| 239      | 1    | 50           | DIFE, tariff 4, unit bit 1, unit bit 0-1-> unit 3 |
| 240      | 1    | 84           | VIF for units kvarh with resolution 0,01kvarh     |
| 241      | 1    | xx           | VIFE status                                       |
| 242-247  | 6    | xxxxxxxxxxxx | Reactive exported energy, Tariff 4                |
| 248      | 1    | 01           | DIF size, 8 bit integer                           |
| 249      | 1    | FF           | VIF next byte is manufacturer specific            |



| Byte No. | Size | Value | Description                                       |
|----------|------|-------|---|
| 250      | 1    | AD    | VIFE number of elements                           |
| 251      | 1    | xx    | VIFE status                                       |
| 252      | 1    | xx    | Number of elements                                |
| 253      | 1    | 1F    | DIF, more records will follow in next telegram    |
| 254      | 1    | xx    | CS checksum, calculated from C field to last data |
| 255      | 1    | 16    | Stop character                                    |

**10.3.4 Example of the 4th telegram (all values are hexadecimal)**

| Byte No. | Size | Value   | Description  |
|----------|------|---------|--|
| 1        | 1    | 68      | Start character                                    |
| 2        | 1    | AE      | L-field, calculated from C field to last user data |
| 3        | 1    | AE      | L-field, repeated                                  |
| 4        | 1    | 68      | Start character                                    |
| 5        | 1    | 08      | C-field, RSP_UD                                    |
| 6        | 1    | xx      | A-field, address                                   |
| 7        | 1    | 72      | CI-field, variable data respond, LSB first         |
| 8-11     | 4    | xxxxxxx | Identification Number, 8 BCD digits                |
| 12-13    | 2    | 4204    | Manufacturer: ABB                                  |
| 14       | 1    | 02      | Version  |
| 15       | 1    | 02      | Medium, 02 = Electricity                           |
| 16       | 1    | xx      | Number of accesses                                 |
| 17       | 1    | xx      | Status   |
| 18-19    | 2    | 0000    | Signature (0000 = no encryption)                   |
| 20       | 1    | 01      | DIF size, 8 bit integer                            |
| 21       | 1    | FF      | VIF next byte is manufacturer specific             |
| 22       | 1    | 97      | VIFE current quadrant                              |
| 23       | 1    | xx      | VIFE status  |
| 24       | 1    | xx      | Current quadrant, total                            |
| 25       | 1    | 01      | DIF size, 8 bit integer                            |
| 26       | 1    | FF      | VIF next byte is manufacturer specific             |
| 27       | 1    | 97      | VIFE current quadrant                              |
| 28       | 1    | FF      | VIF next byte is manufacturer specific             |
| 29       | 1    | 81      | VIFE L1  |
| 30       | 1    | xx      | VIFE status  |
| 31       | 1    | xx      | Current quadrant, L1                               |
| 32       | 1    | 01      | DIF size, 8 bit integer                            |
| 33       | 1    | FF      | VIF next byte is manufacturer specific             |
| 34       | 1    | 97      | VIFE current quadrant                              |
| 35       | 1    | FF      | VIF next byte is manufacturer specific             |
| 36       | 1    | 82      | VIFE L2  |
| 37       | 1    | xx      | VIFE status  |

| Byte No. | Size | Value | Description                            |
|----------|------|-------|--|
| 38       | 1    | xx    | Current quadrant, L2                   |
| 39       | 1    | 01    | DIF size, 8 bit integer                |
| 40       | 1    | FF    | VIF next byte is manufacturer specific |
| 41       | 1    | 97    | VIFE current quadrant                  |
| 42       | 1    | FF    | VIF next byte is manufacturer specific |
| 43       | 1    | 83    | VIFE L3                                |
| 44       | 1    | xx    | VIFE status                            |
| 45       | 1    | xx    | Current quadrant, L3                   |
| 46       | 1    | 81    | DIF size, 8 bit integer                |
| 47       | 1    | 40    | DIFE (Unit = 1)                        |
| 48       | 1    | FD    | VIF extension of VIF-codes             |
| 49       | 1    | 9A    | VIFE digital output                    |
| 50       | 1    | xx    | VIFE status                            |
| 51       | 1    | xx    | Output 1, current state                |
| 52       | 1    | 81    | DIF size, 8 bit integer                |
| 53       | 1    | 80    | DIFE,                                  |
| 54       | 1    | 40    | DIFE (Unit = 2)                        |
| 55       | 1    | FD    | VIF extension of VIF-codes             |
| 56       | 1    | 9A    | VIFE digital output                    |
| 57       | 1    | xx    | VIFE status                            |
| 58       | 1    | xx    | Output 2, current state                |
| 59       | 1    | 81    | DIF size, 8 bit integer                |
| 60       | 1    | C0    | DIFE (Unit = 1)                        |
| 61       | 1    | 40    | DIFE (Unit = 2)                        |
| 62       | 1    | FD    | VIF extension of VIF-codes             |
| 63       | 1    | 9A    | VIFE digital output                    |
| 64       | 1    | xx    | VIFE status                            |
| 65       | 1    | xx    | Output 3, current state                |
| 66       | 1    | 81    | DIF size, 8 bit integer                |
| 67       | 1    | 80    | DIFE,                                  |
| 68       | 1    | 80    | DIFE,                                  |
| 69       | 1    | 40    | DIFE (Unit = 4)                        |
| 70       | 1    | FD    | VIF extension of VIF-codes             |
| 71       | 1    | 9A    | VIFE digital output                    |
| 72       | 1    | xx    | VIFE status                            |
| 73       | 1    | xx    | Output 4, current state                |
| 74       | 1    | 81    | DIF size, 8 bit integer                |
| 75       | 1    | 40    | DIFE (Unit = 1)                        |
| 76       | 1    | FD    | VIF extension of VIF-codes             |
| 77       | 1    | 9B    | VIFE digital input                     |
| 78       | 1    | xx    | VIFE status                            |

| Byte No. | Size | Value | Description   |
|----------|------|-------|---|
| 79       | 1    | xx    | Input 1 current state                                 |
| 80       | 1    | 81    | DIF size, 8 bit integer                               |
| 81       | 1    | 80    | DIFE,   |
| 82       | 1    | 40    | DIFE (Unit = 2)                                       |
| 83       | 1    | FD    | VIF extension of VIF-codes                            |
| 84       | 1    | 9B    | VIFE digital input                                    |
| 85       | 1    | xx    | VIFE status   |
| 86       | 1    | xx    | Input 2 current state                                 |
| 87       | 1    | 81    | DIF size, 8 bit integer                               |
| 88       | 1    | C0    | DIFE (Unit = 1)                                       |
| 89       | 1    | 40    | DIFE (Unit = 2)                                       |
| 90       | 1    | FD    | VIF extension of VIF-codes                            |
| 91       | 1    | 9B    | VIFE digital input                                    |
| 92       | 1    | xx    | VIFE status   |
| 93       | 1    | xx    | Input 3 current state                                 |
| 94       | 1    | 81    | DIF size, 8 bit integer                               |
| 95       | 1    | 80    | DIFE,   |
| 96       | 1    | 80    | DIFE,   |
| 97       | 1    | 40    | DIFE (Unit = 4)                                       |
| 98       | 1    | FD    | VIF extension of VIF-codes                            |
| 99       | 1    | 9B    | VIFE digital input                                    |
| 100      | 1    | xx    | VIFE status   |
| 101      | 1    | xx    | Input 4 current state                                 |
| 102      | 1    | C1    | DIF size, 8 bit integer, storage number 1             |
| 103      | 1    | 40    | DIFE (Unit = 1)                                       |
| 104      | 1    | FD    | VIF extension of VIF-codes                            |
| 105      | 1    | 9B    | VIFE digital input                                    |
| 106      | 1    | xx    | VIFE status   |
| 107      | 1    | xx    | Input 1, stored state (1 if current state has been 1) |
| 108      | 1    | C1    | DIF size, 8 bit integer, storage number 1             |
| 109      | 1    | 80    | DIFE,   |
| 110      | 1    | 40    | DIFE (Unit = 2)                                       |
| 111      | 1    | FD    | VIF extension of VIF-codes                            |
| 112      | 1    | 9B    | VIFE digital input                                    |
| 113      | 1    | xx    | VIFE status   |
| 114      | 1    | xx    | Input 2, stored state (1 if current state has been 1) |
| 115      | 1    | C1    | DIF size, 8 bit integer, storage number 1             |
| 116      | 1    | C0    | DIFE (Unit = 1)                                       |
| 117      | 1    | 40    | DIFE (Unit = 2)                                       |
| 118      | 1    | FD    | VIF extension of VIF-codes                            |
| 119      | 1    | 9B    | VIFE digital input                                    |

| Byte No. | Size | Value        | Description   |
|----------|------|--------------|---|
| 120      | 1    | xx           | VIFE status   |
| 121      | 1    | xx           | Input 3, stored state (1 if current state has been 1) |
| 122      | 1    | C1           | DIF size, 8 bit integer, storage number 1             |
| 123      | 1    | 80           | DIFE,   |
| 124      | 1    | 80           | DIFE,   |
| 125      | 1    | 40           | DIFE (Unit = 4)                                       |
| 126      | 1    | FD           | VIF extension of VIF-codes                            |
| 127      | 1    | 9B           | VIFE digital input                                    |
| 128      | 1    | xx           | VIFE status   |
| 129      | 1    | xx           | Input 4, stored state (1 if current state has been 1) |
| 130      | 1    | 8E           | DIF size, 12 digit BCD                                |
| 131      | 1    | 40           | DIFE (Unit = 1)                                       |
| 132      | 1    | FD           | VIF extension of VIF-codes                            |
| 133      | 1    | E1           | VIFE cumulating counter                               |
| 134      | 1    | xx           | VIFE status   |
| 135-140  | 6    | xxxxxxxxxxxx | Counter 1 (input 1)                                   |
| 141      | 1    | 8E           | DIF size, 12 digit BCD                                |
| 142      | 1    | 80           | DIFE,   |
| 143      | 1    | 40           | DIFE (Unit = 2)                                       |
| 144      | 1    | FD           | VIF extension of VIF-codes                            |
| 145      | 1    | E1           | VIFE cumulating counter                               |
| 146      | 1    | xx           | VIFE status   |
| 147-152  | 6    | xxxxxxxxxxxx | Counter 2 (input 2)                                   |
| 153      | 1    | 8E           | DIF size, 12 digit BCD                                |
| 154      | 1    | C0           | DIFE (Unit = 1)                                       |
| 155      | 1    | 40           | DIFE (Unit = 2)                                       |
| 156      | 1    | FD           | VIF extension of VIF-codes                            |
| 157      | 1    | E1           | VIFE cumulating counter                               |
| 158      | 1    | xx           | VIFE status   |
| 159-164  | 6    | xxxxxxxxxxxx | Counter 3 (input 3)                                   |
| 165      | 1    | 8E           | DIF size, 12 digit BCD                                |
| 166      | 1    | 80           | DIFE,   |
| 167      | 1    | 80           | DIFE,   |
| 168      | 1    | 40           | DIFE (Unit = 4)                                       |
| 169      | 1    | FD           | VIF extension of VIF-codes                            |
| 170      | 1    | E1           | VIFE cumulating counter                               |
| 171      | 1    | xx           | VIFE status   |
| 172-177  | 6    | xxxxxxxxxxxx | Counter 4 (input 4)                                   |
| 178      | 1    | 1F           | DIF, more records will follow in next telegram        |
| 179      | 1    | xx           | CS checksum, calculated from C field to last data     |
| 180      | 1    | 16           | Stop character  |

**10.3.5 Example of the 5th telegram (all values are hexadecimal)**

| Byte No. | Size | Value       | Description  |
|----------|------|-------------|--|
| 1        | 1    | 68          | Start character                                    |
| 2        | 1    | A4          | L-field, calculated from C field to last user data |
| 3        | 1    | A4          | L-field, repeated                                  |
| 4        | 1    | 68          | Start character                                    |
| 5        | 1    | 08          | C-field, RSP_UD                                    |
| 6        | 1    | xx          | A-field, address                                   |
| 7        | 1    | 72          | CI-field, variable data respond, LSB first         |
| 8-11     | 4    | xxxxxxx     | Identification Number, 8 BCD digits                |
| 12-13    | 2    | 4204        | Manufacturer: ABB                                  |
| 14       | 1    | 02          | Version  |
| 15       | 1    | 02          | Medium, 02 = Electricity                           |
| 16       | 1    | xx          | Number of accesses                                 |
| 17       | 1    | xx          | Status   |
| 18-19    | 2    | 0000        | Signature (0000 = no encryption)                   |
| 20       | 1    | 0E          | DIF size, 12 digit BCD                             |
| 21       | 1    | 84          | VIF for units kWh with resolution 0,01kWh          |
| 22       | 1    | FF          | VIFE next byte is manufacturer specific            |
| 23       | 1    | F2          | VIFE resettable energy                             |
| 24       | 1    | xx          | VIFE status  |
| 25-30    | 6    | xxxxxxxxxxx | Resettable active imported energy, Total           |
| 31       | 1    | 8E          | DIF size, 12 digit BCD                             |
| 32       | 1    | 40          | DIFE (Unit = 1)                                    |
| 33       | 1    | 84          | VIF for units kWh with resolution 0,01kWh          |
| 34       | 1    | FF          | VIFE next byte is manufacturer specific            |
| 35       | 1    | F2          | VIFE resettable energy                             |
| 36       | 1    | xx          | VIFE status  |
| 37-42    | 6    | xxxxxxxxxxx | Resettable active exported energy, Total           |
| 43       | 1    | 8E          | DIF size, 12 digit BCD                             |
| 44       | 1    | 80          | DIFE   |
| 45       | 1    | 40          | DIFE (Unit = 2)                                    |
| 46       | 1    | 84          | VIF for units kvarh with resolution 0,01kvarh      |
| 47       | 1    | FF          | VIFE next byte is manufacturer specific            |
| 48       | 1    | F2          | VIFE resettable energy                             |
| 49       | 1    | xx          | VIFE status  |
| 50-55    | 6    | xxxxxxxxxxx | Resettable reactive imported energy, Total         |
| 56       | 1    | 8E          | DIF size, 12 digit BCD                             |
| 57       | 1    | C0          | DIFE (Unit = 1)                                    |
| 58       | 1    | 40          | DIFE (Unit = 2)                                    |
| 59       | 1    | 84          | VIF for units kvar with resolution 0,01kvarh       |
| 60       | 1    | FF          | VIFE next byte is manufacturer specific            |

| Byte No. | Size | Value        | Description                                       |
|----------|------|--------------|---|
| 61       | 1    | F2           | VIFE resettable energy                            |
| 62       | 1    | xx           | VIFE status                                       |
| 63-68    | 6    | xxxxxxxxxxxx | Resettable reactive exported energy, Total        |
| 69       | 1    | 04           | DIF size, 32 bit integer                          |
| 70       | 1    | FF           | VIFE next byte is manufacturer specific           |
| 71       | 1    | F1           | VIFE reset counter                                |
| 72       | 1    | xx           | VIFE status                                       |
| 73-76    | 4    | xxxxxxx      | Reset counter for active imported energy, Total   |
| 77       | 1    | 84           | DIF size, 32 bit integer                          |
| 78       | 1    | 40           | DIFE (Unit = 1)                                   |
| 79       | 1    | FF           | VIFE next byte is manufacturer specific           |
| 80       | 1    | F1           | VIFE reset counter                                |
| 81       | 1    | xx           | VIFE status                                       |
| 82-85    | 4    | xxxxxxx      | Reset counter for active exported energy, Total   |
| 86       | 1    | 84           | DIF size, 32 bit integer                          |
| 87       | 1    | 80           | DIFE  |
| 88       | 1    | 40           | DIFE (Unit = 2)                                   |
| 89       | 1    | FF           | VIFE next byte is manufacturer specific           |
| 90       | 1    | F1           | VIFE reset counter                                |
| 91       | 1    | xx           | VIFE status                                       |
| 92-95    | 4    | xxxxxxx      | Reset counter for reactive imported energy, Total |
| 96       | 1    | 84           | DIF size, 32 bit integer                          |
| 97       | 1    | C0           | DIFE (Unit = 1)                                   |
| 98       | 1    | 40           | DIFE (Unit = 2)                                   |
| 99       | 1    | FF           | VIFE next byte is manufacturer specific           |
| 100      | 1    | F1           | VIFE reset counter                                |
| 101      | 1    | xx           | VIFE status                                       |
| 102-105  | 4    | xxxxxxx      | Reset counter for reactive exported energy, Total |
| 106      | 1    | 0E           | DIF size, 12 digit BCD                            |
| 107      | 1    | FF           | VIFE next byte is manufacturer specific           |
| 108      | 1    | F9           | VIF extension of manufacturer specific VIFE's     |
| 109      | 1    | C4           | Energy in CO2 with resolution 0,001 kg            |
| 110      | 1    | xx           | VIFE status                                       |
| 111-116  | 6    | xxxxxxxxxxxx | CO2 for active imported energy, Total             |
| 117      | 1    | 0E           | DIF size, 12 digit BCD                            |
| 118      | 1    | FF           | VIFE next byte is manufacturer specific           |
| 119      | 1    | F9           | VIF extension of manufacturer specific VIFE's     |
| 120      | 1    | C9           | Energy in Currency with resolution 0,01 currency  |
| 121      | 1    | xx           | VIFE status                                       |
| 122-127  | 6    | xxxxxxxxxxxx | Currency for active imported energy, Total        |
| 128      | 1    | 04           | DIF size, 32 bit integer                          |

| Byte No. | Size | Value       | Description                                       |
|----------|------|-------------|---|
| 129      | 1    | FF          | VIFE next byte is manufacturer specific           |
| 130      | 1    | A4          | CO2 conversion factor in g/kWh                    |
| 131      | 1    | xx          | VIFE status                                       |
| 132-133  | 4    | xxxxxxx     | CO2 conversion factor for active energy           |
| 134      | 1    | 04          | DIF size, 32 bit integer                          |
| 135      | 1    | FF          | VIFE next byte is manufacturer specific           |
| 136      | 1    | A5          | Currency conversion factor in 0,001 currency/kWh  |
| 137      | 1    | xx          | VIFE status                                       |
| 138-143  | 4    | xxxxxxx     | Currency conversion factor for active energy      |
| 144      | 1    | 8E          | DIF size, 12 digit BCD                            |
| 145      | 1    | 80          | DIFE  |
| 146      | 1    | 80          | DIFE  |
| 147      | 1    | 40          | DIFE, Unit 4                                      |
| 148      | 1    | 84          | VIF for unit kVAh with resolution 0,01kVAh        |
| 149      | 1    | xx          | VIFE status                                       |
| 150-155  | 6    | xxxxxxxxxxx | Apparent imported energy, Total                   |
| 156      | 1    | 8E          | DIF size, 12 digit BCD                            |
| 157      | 1    | C0          | DIFE, Unit bit 0                                  |
| 158      | 1    | 80          | DIFE, Unit bit 1                                  |
| 159      | 1    | 40          | DIFE, Unit bit 2, Unit bit 0-2 -> Unit 5          |
| 160      | 1    | 84          | VIF for unit kVAh with resolution 0,01kVAh        |
| 161      | 1    | xx          | VIFE status                                       |
| 162-167  | 6    | xxxxxxxxxxx | Apparent exported energy, Total                   |
| 168      | 1    | 1F          | DIF, more records will follow in next telegram    |
| 169      | 1    | xx          | CS checksum, calculated from C field to last data |
| 170      | 1    | 16          | Stop character                                    |

### 10.3.6 Example of the 6th telegram (all values are hexadecimal)

| Byte No. | Size | Value   | Description  |
|----------|------|---------|--|
| 1        | 1    | 68      | Start character                                    |
| 2        | 1    | F7      | L-field, calculated from C field to last user data |
| 3        | 1    | F7      | L-field, repeated                                  |
| 4        | 1    | 68      | Start character                                    |
| 5        | 1    | 08      | C-field, RSP_UD                                    |
| 6        | 1    | xx      | A-field, address                                   |
| 7        | 1    | 72      | CI-field, variable data respond, LSB first         |
| 8-11     | 4    | xxxxxxx | Identification Number, 8 BCD digits                |
| 12-13    | 2    | 4204    | Manufacturer: ABB                                  |
| 14       | 1    | 02      | Version  |
| 15       | 1    | 02      | Medium, 02 = Electricity                           |
| 16       | 1    | xx      | Number of accesses                                 |

| Byte No. | Size | Value       | Description                                    |
|----------|------|-------------|--|
| 17       | 1    | xx          | Status   |
| 18-19    | 2    | 0000        | Signature (0000 = no encryption)               |
| 20       | 1    | 0E          | DIF size, 12 digit BCD                         |
| 21       | 1    | 84          | VIF for units kWh with resolution 0,01kWh      |
| 22       | 1    | FF          | VIFE next byte is manufacturer specific        |
| 23       | 1    | 81          | VIFE L1  |
| 24       | 1    | xx          | VIFE status                                    |
| 25-30    | 6    | xxxxxxxxxxx | Active imported energy, L1                     |
| 31       | 1    | 0E          | DIF size, 12 digit BCD                         |
| 32       | 1    | 84          | VIF for units kWh with resolution 0,01kWh      |
| 33       | 1    | FF          | VIFE next byte is manufacturer specific        |
| 34       | 1    | 82          | VIFE L2  |
| 35       | 1    | xx          | VIFE status                                    |
| 36-41    | 6    | xxxxxxxxxxx | Active imported energy, L2                     |
| 42       | 1    | 0E          | DIF size, 12 digit BCD                         |
| 43       | 1    | 84          | VIF for units kWh with resolution 0,01kWh      |
| 44       | 1    | FF          | VIFE next byte is manufacturer specific        |
| 45       | 1    | 83          | VIFE L3  |
| 46       | 1    | xx          | VIFE status                                    |
| 47-52    | 6    | xxxxxxxxxxx | Active imported energy, L3                     |
| 53       | 1    | 8E          | DIF size, 12 digit BCD                         |
| 54       | 1    | 80          | DIFE   |
| 55       | 1    | 40          | DIFE, Unit 2                                   |
| 56       | 1    | 84          | VIF for units kvarh with resolution 0,01 kvarh |
| 57       | 1    | FF          | VIFE next byte is manufacturer specific        |
| 58       | 1    | 81          | VIFE L1  |
| 59       | 1    | xx          | VIFE status                                    |
| 60-65    | 6    | xxxxxxxxxxx | Reactive imported energy, L1                   |
| 66       | 1    | 8E          | DIF size, 12 digit BCD                         |
| 67       | 1    | 80          | DIFE   |
| 68       | 1    | 40          | DIFE, Unit 2                                   |
| 69       | 1    | 84          | VIF for units kvarh with resolution 0,01 kvarh |
| 70       | 1    | FF          | VIFE next byte is manufacturer specific        |
| 71       | 1    | 82          | VIFE L2  |
| 72       | 1    | xx          | VIFE status                                    |
| 73-78    | 6    | xxxxxxxxxxx | Reactive imported energy, L2                   |
| 79       | 1    | 8E          | DIF size, 12 digit BCD                         |
| 80       | 1    | 80          | DIFE   |
| 81       | 1    | 40          | DIFE, Unit 2                                   |
| 82       | 1    | 84          | VIF for units kvarh with resolution 0,01 kvarh |
| 83       | 1    | FF          | VIFE next byte is manufacturer specific        |



| Byte No. | Size | Value        | Description                                |
|----------|------|--------------|--|
| 84       | 1    | 83           | VIFE L3                                    |
| 85       | 1    | xx           | VIFE status                                |
| 86-91    | 6    | xxxxxxxxxxxx | Reactive imported energy, L3               |
| 92       | 1    | 8E           | DIF size, 12 digit BCD                     |
| 93       | 1    | 80           | DIFE                                       |
| 94       | 1    | 80           | DIFE                                       |
| 95       | 1    | 40           | DIFE, Unit 4                               |
| 96       | 1    | 84           | VIF for unit kVAh with resolution 0,01kVAh |
| 97       | 1    | FF           | VIFE next byte is manufacturer specific    |
| 98       | 1    | 81           | VIFE L1                                    |
| 99       | 1    | xx           | VIFE status                                |
| 100-105  | 6    | xxxxxxxxxxxx | Apparent imported energy, L1               |
| 106      | 1    | 8E           | DIF size, 12 digit BCD                     |
| 107      | 1    | 80           | DIFE                                       |
| 108      | 1    | 80           | DIFE                                       |
| 109      | 1    | 40           | DIFE, Unit 4                               |
| 110      | 1    | 84           | VIF for unit kVAh with resolution 0,01kVAh |
| 111      | 1    | FF           | VIFE next byte is manufacturer specific    |
| 112      | 1    | 82           | VIFE L2                                    |
| 113      | 1    | xx           | VIFE status                                |
| 114-119  | 6    | xxxxxxxxxxxx | Apparent imported energy, L2               |
| 120      | 1    | 8E           | DIF size, 12 digit BCD                     |
| 121      | 1    | 80           | DIFE                                       |
| 122      | 1    | 80           | DIFE                                       |
| 123      | 1    | 40           | DIFE, Unit 4                               |
| 124      | 1    | 84           | VIF for unit kVAh with resolution 0,01kVAh |
| 125      | 1    | FF           | VIFE next byte is manufacturer specific    |
| 126      | 1    | 83           | VIFE L3                                    |
| 127      | 1    | xx           | VIFE status                                |
| 128-133  | 6    | xxxxxxxxxxxx | Apparent imported energy, L3               |
| 134      | 1    | 8E           | DIF size, 12 digit BCD                     |
| 135      | 1    | 40           | DIFE, Unit 1                               |
| 136      | 1    | 84           | VIF for units kWh with resolution 0,01kWh  |
| 137      | 1    | FF           | VIFE next byte is manufacturer specific    |
| 138      | 1    | 81           | VIFE L1                                    |
| 139      | 1    | xx           | VIFE status                                |
| 140-145  | 6    | xxxxxxxxxxxx | Active exported energy, L1                 |
| 146      | 1    | 8E           | DIF size, 12 digit BCD                     |
| 147      | 1    | 40           | DIFE, Unit 1                               |
| 148      | 1    | 84           | VIF for units kWh with resolution 0,01kWh  |
| 149      | 1    | FF           | VIFE next byte is manufacturer specific    |

| Byte No. | Size | Value        | Description                                    |
|----------|------|--------------|--|
| 150      | 1    | 82           | VIFE L2  |
| 151      | 1    | xx           | VIFE status                                    |
| 152-157  | 6    | xxxxxxxxxxxx | Active exported energy, L2                     |
| 158      | 1    | 8E           | DIF size, 12 digit BCD                         |
| 159      | 1    | 40           | DIFE, Unit 1                                   |
| 160      | 1    | 84           | VIF for units kWh with resolution 0,01kWh      |
| 161      | 1    | FF           | VIFE next byte is manufacturer specific        |
| 162      | 1    | 83           | VIFE L3  |
| 163      | 1    | xx           | VIFE status                                    |
| 164-169  | 6    | xxxxxxxxxxxx | Active exported energy, L3                     |
| 170      | 1    | 8E           | DIF size, 12 digit BCD                         |
| 171      | 1    | C0           | DIFE, Unit bit 0                               |
| 172      | 1    | 40           | DIFE, Unit bit 1, unit bit0-1-> unit 3         |
| 173      | 1    | 84           | VIF for units kvarh with resolution 0,01 kvarh |
| 174      | 1    | FF           | VIFE next byte is manufacturer specific        |
| 175      | 1    | 81           | VIFE L1  |
| 176      | 1    | xx           | VIFE status                                    |
| 177-182  | 6    | xxxxxxxxxxxx | Reactive exported energy, L1                   |
| 183      | 1    | 8E           | DIF size, 12 digit BCD                         |
| 184      | 1    | C0           | DIFE, Unit bit 0                               |
| 185      | 1    | 40           | DIFE, Unit bit 1, unit bit0-1-> unit 3         |
| 186      | 1    | 84           | VIF for units kvarh with resolution 0,01 kvarh |
| 187      | 1    | FF           | VIFE next byte is manufacturer specific        |
| 188      | 1    | 82           | VIFE L2  |
| 189      | 1    | xx           | VIFE status                                    |
| 190-195  | 6    | xxxxxxxxxxxx | Reactive exported energy, L2                   |
| 196      | 1    | 8E           | DIF size, 12 digit BCD                         |
| 197      | 1    | C0           | DIFE, Unit bit 0                               |
| 198      | 1    | 40           | DIFE, Unit bit 1, unit bit0-1-> unit 3         |
| 199      | 1    | 84           | VIF for units kvarh with resolution 0,01 kvarh |
| 200      | 1    | FF           | VIFE next byte is manufacturer specific        |
| 201      | 1    | 83           | VIFE L3  |
| 202      | 1    | xx           | VIFE status                                    |
| 203-208  | 6    | xxxxxxxxxxxx | Reactive exported energy, L3                   |
| 209      | 1    | 8E           | DIF size, 12 digit BCD                         |
| 210      | 1    | C0           | DIFE, Unit bit 0                               |
| 211      | 1    | 80           | DIFE, Unit bit 1                               |
| 212      | 1    | 40           | DIFE, Unit bit 2, unit bit0-2-> unit 5         |
| 213      | 1    | 84           | VIF for unit kVAh with resolution 0,01kVAh     |
| 214      | 1    | FF           | VIFE next byte is manufacturer specific        |
| 215      | 1    | 81           | VIFE L1  |

| Byte No. | Size | Value       | Description                                       |
|----------|------|-------------|---|
| 216      | 1    | xx          | VIFE status                                       |
| 217-222  | 6    | xxxxxxxxxxx | Apparent exported energy, L1                      |
| 223      | 1    | 8E          | DIF size, 12 digit BCD                            |
| 224      | 1    | C0          | DIFE, Unit bit 0                                  |
| 225      | 1    | 80          | DIFE, Unit bit 1                                  |
| 226      | 1    | 40          | DIFE, Unit bit 2, unit bit0-2-> unit 5            |
| 227      | 1    | 84          | VIF for unit kVAh with resolution 0,01kVAh        |
| 228      | 1    | FF          | VIFE next byte is manufacturer specific           |
| 229      | 1    | 82          | VIFE L2   |
| 230      | 1    | xx          | VIFE status                                       |
| 231-236  | 6    | xxxxxxxxxxx | Apparent exported energy, L2                      |
| 237      | 1    | 8E          | DIF size, 12 digit BCD                            |
| 238      | 1    | C0          | DIFE, Unit bit 0                                  |
| 239      | 1    | 80          | DIFE, Unit bit 1                                  |
| 240      | 1    | 40          | DIFE, Unit bit 2, unit bit0-2-> unit 5            |
| 241      | 1    | 84          | VIF for unit kVAh with resolution 0,01kVAh        |
| 242      | 1    | FF          | VIFE next byte is manufacturer specific           |
| 243      | 1    | 83          | VIFE L3   |
| 244      | 1    | xx          | VIFE status                                       |
| 245-250  | 6    | xxxxxxxxxxx | Apparent exported energy, L3                      |
| 251      | 1    | 1F          | DIF, more records will follow in next telegram    |
| 252      | 1    | xx          | CS checksum, calculated from C field to last data |
| 253      | 1    | 16          | Stop character                                    |

### 10.3.7 Example of the 7th telegram (all values are hexadecimal)

| Byte No. | Size | Value   | Description  |
|----------|------|---------|--|
| 1        | 1    | 68      | Start character                                    |
| 2        | 1    | B6      | L-field, calculated from C field to last user data |
| 3        | 1    | B6      | L-field, repeated                                  |
| 4        | 1    | 68      | Start character                                    |
| 5        | 1    | 08      | C-field, RSP_UD                                    |
| 6        | 1    | xx      | A-field, address                                   |
| 7        | 1    | 72      | CI-field, variable data respond, LSB first         |
| 8-11     | 4    | xxxxxxx | Identification Number, 8 BCD digits                |
| 12-13    | 2    | 4204    | Manufacturer: ABB                                  |
| 14       | 1    | 02      | Version  |
| 15       | 1    | 02      | Medium, 02 = Electricity                           |
| 16       | 1    | xx      | Number of accesses                                 |
| 17       | 1    | xx      | Status   |
| 18-19    | 2    | 0000    | Signature (0000 = no encryption)                   |
| 20       | 1    | 8E      | DIF size, 12 digit BCD                             |

| Byte No. | Size | Value       | Description                                  |
|----------|------|-------------|--|
| 21       | 1    | 80          | DIFE   |
| 22       | 1    | C0          | DIFE, Unit 2                                 |
| 23       | 1    | 40          | DIFE, Unit 4                                 |
| 24       | 1    | 84          | VIF for unit kWh with resolution 0,01kWh     |
| 25       | 1    | xx          | VIFE status                                  |
| 26-31    | 6    | xxxxxxxxxxx | Active net energy, Total                     |
| 32       | 1    | 8E          | DIF size, 12 digit BCD                       |
| 33       | 1    | 80          | DIFE   |
| 34       | 1    | C0          | DIFE, Unit 2                                 |
| 35       | 1    | 40          | DIFE, Unit 4                                 |
| 36       | 1    | 84          | VIF for unit kWh with resolution 0,01kWh     |
| 37       | 1    | FF          | VIFE next byte is manufacturer specific      |
| 38       | 1    | 81          | VIFE L1                                      |
| 39       | 1    | xx          | VIFE status                                  |
| 40-45    | 6    | xxxxxxxxxxx | Active net energy, L1                        |
| 46       | 1    | 8E          | DIF size, 12 digit BCD                       |
| 47       | 1    | 80          | DIFE   |
| 48       | 1    | C0          | DIFE, Unit 2                                 |
| 49       | 1    | 40          | DIFE, Unit 4                                 |
| 50       | 1    | 84          | VIF for unit kWh with resolution 0,01kWh     |
| 51       | 1    | FF          | VIFE next byte is manufacturer specific      |
| 52       | 1    | 82          | VIFE L2                                      |
| 53       | 1    | xx          | VIFE status                                  |
| 54-59    | 6    | xxxxxxxxxxx | Active net energy, L2                        |
| 60       | 1    | 8E          | DIF size, 12 digit BCD                       |
| 61       | 1    | 80          | DIFE   |
| 62       | 1    | C0          | DIFE, Unit 2                                 |
| 63       | 1    | 40          | DIFE, Unit 4                                 |
| 64       | 1    | 84          | VIF for unit kWh with resolution 0,01kWh     |
| 65       | 1    | FF          | VIFE next byte is manufacturer specific      |
| 66       | 1    | 83          | VIFE L3                                      |
| 67       | 1    | xx          | VIFE status                                  |
| 68-73    | 6    | xxxxxxxxxxx | Active net energy, L3                        |
| 74       | 1    | 8E          | DIF size, 12 digit BCD                       |
| 75       | 1    | C0          | DIFE, Unit 1                                 |
| 76       | 1    | C0          | DIFE, Unit 2                                 |
| 77       | 1    | 40          | DIFE, Unit 4                                 |
| 78       | 1    | 84          | VIF for unit kvarh with resolution 0,01kvarh |
| 79       | 1    | xx          | VIFE status                                  |
| 80-85    | 6    | xxxxxxxxxxx | Reactive net energy, Total                   |
| 86       | 1    | 8E          | DIF size, 12 digit BCD                       |

| Byte No. | Size | Value       | Description                                  |
|----------|------|-------------|--|
| 87       | 1    | C0          | DIFE, Unit 1                                 |
| 88       | 1    | C0          | DIFE, Unit 2                                 |
| 89       | 1    | 40          | DIFE, Unit 4                                 |
| 90       | 1    | 84          | VIF for unit kvarh with resolution 0,01kvarh |
| 91       | 1    | FF          | VIFE next byte is manufacturer specific      |
| 92       | 1    | 81          | VIFE L1                                      |
| 93       | 1    | xx          | VIFE status                                  |
| 94-99    | 6    | xxxxxxxxxxx | Reactive net energy, L1                      |
| 100      | 1    | 8E          | DIF size, 12 digit BCD                       |
| 101      | 1    | C0          | DIFE, Unit 1                                 |
| 102      | 1    | C0          | DIFE, Unit 2                                 |
| 103      | 1    | 40          | DIFE, Unit 4                                 |
| 104      | 1    | 84          | VIF for unit kvarh with resolution 0,01kvarh |
| 105      | 1    | FF          | VIFE next byte is manufacturer specific      |
| 106      | 1    | 82          | VIFE L2                                      |
| 107      | 1    | xx          | VIFE status                                  |
| 108-113  | 6    | xxxxxxxxxxx | Reactive net energy, L2                      |
| 114      | 1    | 8E          | DIF size, 12 digit BCD                       |
| 115      | 1    | C0          | DIFE, Unit 1                                 |
| 116      | 1    | C0          | DIFE, Unit 2                                 |
| 117      | 1    | 40          | DIFE, Unit 4                                 |
| 118      | 1    | 84          | VIF for unit kvarh with resolution 0,01kvarh |
| 119      | 1    | FF          | VIFE next byte is manufacturer specific      |
| 120      | 1    | 83          | VIFE L3                                      |
| 121      | 1    | xx          | VIFE status                                  |
| 122-127  | 6    | xxxxxxxxxxx | Reactive net energy, L3                      |
| 128      | 1    | 8E          | DIF size, 12 digit BCD                       |
| 129      | 1    | 80          | DIFE   |
| 130      | 1    | 80          | DIFE   |
| 131      | 1    | 80          | DIFE   |
| 132      | 1    | 40          | DIFE, Unit 8                                 |
| 133      | 1    | 84          | VIF for unit kVAh with resolution 0,01kVAh   |
| 134      | 1    | xx          | VIFE status                                  |
| 135-140  | 6    | xxxxxxxxxxx | Apparent net energy, Total                   |
| 141      | 1    | 8E          | DIF size, 12 digit BCD                       |
| 142      | 1    | 80          | DIFE   |
| 143      | 1    | 80          | DIFE   |
| 144      | 1    | 80          | DIFE   |
| 145      | 1    | 40          | DIFE, Unit 8                                 |
| 146      | 1    | 84          | VIF for unit kVAh with resolution 0,01kVAh   |
| 147      | 1    | FF          | VIFE next byte is manufacturer specific      |

| Byte No. | Size | Value        | Description                                       |
|----------|------|--------------|---|
| 148      | 1    | 81           | VIFE L1   |
| 149      | 1    | xx           | VIFE status                                       |
| 150-155  | 6    | xxxxxxxxxxxx | Apparent net energy, L1                           |
| 156      | 1    | 8E           | DIF size, 12 digit BCD                            |
| 157      | 1    | 80           | DIFE  |
| 158      | 1    | 80           | DIFE  |
| 159      | 1    | 80           | DIFE  |
| 160      | 1    | 40           | DIFE, Unit 8                                      |
| 161      | 1    | 84           | VIF for unit kVAh with resolution 0,01kVAh        |
| 162      | 1    | FF           | VIFE next byte is manufacturer specific           |
| 163      | 1    | 82           | VIFE L2   |
| 164      | 1    | xx           | VIFE status                                       |
| 165-170  | 6    | xxxxxxxxxxxx | Apparent net energy, L2                           |
| 171      | 1    | 8E           | DIF size, 12 digit BCD                            |
| 172      | 1    | 80           | DIFE  |
| 173      | 1    | 80           | DIFE  |
| 174      | 1    | 80           | DIFE  |
| 175      | 1    | 40           | DIFE, Unit 8                                      |
| 176      | 1    | 84           | VIF for unit kVAh with resolution 0,01kVAh        |
| 177      | 1    | FF           | VIFE next byte is manufacturer specific           |
| 178      | 1    | 83           | VIFE L3   |
| 179      | 1    | xx           | VIFE status                                       |
| 180-185  | 6    | xxxxxxxxxxxx | Apparent net energy, L3                           |
| 186      | 1    | 1F           | DIF, more records will follow in next telegram    |
| 187      | 1    | xx           | CS checksum, calculated from C field to last data |
| 188      | 1    | 16           | Stop character                                    |

### 10.3.8 Example of the 8th telegram (all values are hexadecimal)

This example telegram contains the most recent snapshot of previous values.

| Byte No. | Size | Value   | Description  |
|----------|------|---------|--|
| 1        | 1    | 68      | Start character                                    |
| 2        | 1    | DE      | L-field, calculated from C field to last user data |
| 3        | 1    | DE      | L-field, repeated                                  |
| 4        | 1    | 68      | Start character                                    |
| 5        | 1    | 08      | C-field, RSP_UD                                    |
| 6        | 1    | xx      | A-field, address                                   |
| 7        | 1    | 72      | CI-field, variable data respond, LSB first         |
| 8-11     | 4    | xxxxxxx | Identification Number, 8 BCD digits                |
| 12-13    | 2    | 4204    | Manufacturer: ABB                                  |
| 14       | 1    | 02      | Version  |
| 15       | 1    | 02      | Medium, 02 = Electricity                           |

| Byte No. | Size | Value       | Description                                   |
|----------|------|-------------|---|
| 16       | 1    | xx          | Number of accesses                            |
| 17       | 1    | xx          | Status  |
| 18-19    | 2    | 0000        | Signature (0000 = no encryption)              |
| 20       | 1    | CE          | DIF size, 12 digit BCD, storage number bit 0  |
| 21       | 1    | 00          | DIFE, storage number bit 1-4                  |
| 22       | 1    | ED          | VIF for time/date point                       |
| 23       | 1    | E8          | VIFE indicating end of period                 |
| 24       | 1    | xx          | VIFE status                                   |
| 25-30    | 6    | xxxxxxxxxxx | Time and date (sec,min,hour,day,month,year)   |
| 31       | 1    | 4E          | DIF size, 12 digit BCD, storage number bit 0  |
| 32       | 1    | 84          | VIF for units kWh with resolution 0,01kWh     |
| 33       | 1    | xx          | VIFE status                                   |
| 34-39    | 6    | xxxxxxxxxxx | Active imported energy, Total                 |
| 40       | 1    | CE          | DIF size, 12 digit BCD, storage number bit 0  |
| 41       | 1    | 40          | DIFE, Unit 1                                  |
| 42       | 1    | 84          | VIF for units kWh with resolution 0,01kWh     |
| 43       | 1    | xx          | VIFE status                                   |
| 44-49    | 6    | xxxxxxxxxxx | Active exported energy, Total                 |
| 50       | 1    | CE          | DIF size, 12 digit BCD, storage number bit 0  |
| 51       | 1    | 80          | DIFE,   |
| 52       | 1    | 40          | DIFE, unit 2                                  |
| 53       | 1    | 84          | VIF for units kvarh with resolution 0,01kvarh |
| 54       | 1    | xx          | VIFE status                                   |
| 55-60    | 6    | xxxxxxxxxxx | Reactive imported energy, Total               |
| 61       | 1    | CE          | DIF size, 12 digit BCD, storage number bit 0  |
| 62       | 1    | C0          | DIFE, unit 1                                  |
| 63       | 1    | 40          | DIFE, unit 2                                  |
| 64       | 1    | 84          | VIF for units kvarh with resolution 0,01kvarh |
| 65       | 1    | xx          | VIFE status                                   |
| 66-71    | 6    | xxxxxxxxxxx | Reactive exported energy, Total               |
| 72       | 1    | 4E          | DIF size, 12 digit BCD, storage number bit 0  |
| 73       | 1    | 84          | VIF for units kWh with resolution 0,01kWh     |
| 74       | 1    | FF          | VIFE next byte is manufacturer specific       |
| 75       | 1    | 81          | VIFE L1                                       |
| 76       | 1    | xx          | VIFE status                                   |
| 77-82    | 6    | xxxxxxxxxxx | Active imported energy, L1                    |
| 83       | 1    | 4E          | DIF size, 12 digit BCD, storage number bit 0  |
| 84       | 1    | 84          | VIF for units kWh with resolution 0,01kWh     |
| 85       | 1    | FF          | VIFE next byte is manufacturer specific       |
| 86       | 1    | 82          | VIFE L2                                       |
| 87       | 1    | xx          | VIFE status                                   |

| Byte No. | Size | Value       | Description                                  |
|----------|------|-------------|--|
| 88-93    | 6    | xxxxxxxxxxx | Active imported energy, L2                   |
| 94       | 1    | 4E          | DIF size, 12 digit BCD, storage number bit 0 |
| 95       | 1    | 84          | VIF for units kWh with resolution 0,01kWh    |
| 96       | 1    | FF          | VIFE next byte is manufacturer specific      |
| 97       | 1    | 83          | VIFE L3                                      |
| 98       | 1    | xx          | VIFE status                                  |
| 99-104   | 6    | xxxxxxxxxxx | Active imported energy, L3                   |
| 105      | 1    | CE          | DIF size, 12 digit BCD, storage number bit 0 |
| 106      | 1    | 40          | DIFE, Unit 1                                 |
| 107      | 1    | 84          | VIF for units kWh with resolution 0,01kWh    |
| 108      | 1    | FF          | VIFE next byte is manufacturer specific      |
| 109      | 1    | 81          | VIFE L1                                      |
| 110      | 1    | xx          | VIFE status                                  |
| 111-116  | 6    | xxxxxxxxxxx | Active exported energy, L1                   |
| 117      | 1    | CE          | DIF size, 12 digit BCD, storage number bit 0 |
| 118      | 1    | 40          | DIFE, Unit 1                                 |
| 119      | 1    | 84          | VIF for units kWh with resolution 0,01kWh    |
| 120      | 1    | FF          | VIFE next byte is manufacturer specific      |
| 121      | 1    | 82          | VIFE L2                                      |
| 122      | 1    | xx          | VIFE status                                  |
| 123-128  | 6    | xxxxxxxxxxx | Active exported energy, L2                   |
| 129      | 1    | CE          | DIF size, 12 digit BCD, storage number bit 0 |
| 130      | 1    | 40          | DIFE, Unit 1                                 |
| 131      | 1    | 84          | VIF for units kWh with resolution 0,01kWh    |
| 132      | 1    | FF          | VIFE next byte is manufacturer specific      |
| 133      | 1    | 83          | VIFE L3                                      |
| 134      | 1    | xx          | VIFE status                                  |
| 135-140  | 6    | xxxxxxxxxxx | Active exported energy, L3                   |
| 141      | 1    | CE          | DIF size, 12 digit BCD, storage number bit 0 |
| 142      | 1    | 10          | DIFE, tariff 1, storage number bit 1-4       |
| 143      | 1    | 84          | VIF for units kWh with resolution 0,01kWh    |
| 144      | 1    | xx          | VIFE status                                  |
| 145-150  | 6    | xxxxxxxxxxx | Active imported energy, tariff 1             |
| 151      | 1    | CE          | DIF size, 12 digit BCD, storage number bit 0 |
| 152      | 1    | 20          | DIFE, tariff 2, storage number bit 1-4       |
| 153      | 1    | 84          | VIF for units kWh with resolution 0,01kWh    |
| 154      | 1    | xx          | VIFE status                                  |
| 155-160  | 6    | xxxxxxxxxxx | Active imported energy, tariff 2             |
| 161      | 1    | CE          | DIF size, 12 digit BCD, storage number bit 0 |
| 162      | 1    | 30          | DIFE, tariff 3, storage number bit 1-4       |
| 163      | 1    | 84          | VIF for units kWh with resolution 0,01kWh    |



| Byte No. | Size | Value       | Description   |
|----------|------|-------------|---|
| 164      | 1    | xx          | VIFE status   |
| 165-170  | 6    | xxxxxxxxxxx | Active imported energy, tariff 3                          |
| 171      | 1    | CE          | DIF size, 12 digit BCD, storage number bit 0              |
| 172      | 1    | 80          | DIFE, tariff bits 0-1, storage number bit 1-4             |
| 173      | 1    | 10          | DIFE, tariff bits 2-3, tariff 4                           |
| 174      | 1    | 84          | VIF for units kWh with resolution 0,01kWh                 |
| 175      | 1    | xx          | VIFE status   |
| 176-181  | 6    | xxxxxxxxxxx | Active imported energy, tariff 4                          |
| 182      | 1    | CE          | DIF size, 12 digit BCD, storage number bit 0              |
| 183      | 1    | 90          | DIFE, tariff 1, storage number bit 1-4, unit bit 0        |
| 184      | 1    | 40          | DIFE, unit bit 1  |
| 185      | 1    | 84          | VIF for units kvarh with resolution 0,01kvarh             |
| 186      | 1    | xx          | VIFE status   |
| 187-192  | 6    | xxxxxxxxxxx | Reactive imported energy, tariff 1                        |
| 193      | 1    | CE          | DIF size, 12 digit BCD, storage number bit 0              |
| 194      | 1    | A0          | DIFE, tariff 2, storage number bit 1-4, unit bit 0        |
| 195      | 1    | 40          | DIFE, unit bit 1  |
| 196      | 1    | 84          | VIF for units kvarh with resolution 0,01kvarh             |
| 197      | 1    | xx          | VIFE status   |
| 198-203  | 6    | xxxxxxxxxxx | Reactive imported energy, tariff 2                        |
| 204      | 1    | CE          | DIF size, 12 digit BCD, storage number bit 0              |
| 205      | 1    | B0          | DIFE, tariff 3, storage number bit 1-4, unit bit 0        |
| 206      | 1    | 40          | DIFE, unit bit 1  |
| 207      | 1    | 84          | VIF for units kvarh with resolution 0,01kvarh             |
| 208      | 1    | xx          | VIFE status   |
| 209-214  | 6    | xxxxxxxxxxx | Reactive imported energy, tariff 3                        |
| 215      | 1    | CE          | DIF size, 12 digit BCD, storage number bit 0              |
| 216      | 1    | 80          | DIFE, tariff bits 0-1, storage number bit 1-4, unit bit 0 |
| 217      | 1    | 50          | DIFE, tariff 4, unit bit 1                                |
| 218      | 1    | 84          | VIF for units kvarh with resolution 0,01kvarh             |
| 219      | 1    | xx          | VIFE status   |
| 220-225  | 6    | xxxxxxxxxxx | Reactive imported energy, tariff 4                        |
| 226      | 1    | 1F          | DIF, more records will follow in next telegram            |
| 227      | 1    | xx          | CS checksum, calculated from C field to last data         |
| 228      | 1    | 16          | Stop character  |

### 10.3.9 Example of the 9th telegram (all values are hexadecimal)

This example telegram contains the most recent snapshot of previous values, continued from telegram 8. Second most recent snapshot would be sent out in 10th and 11th telegram, and so on.

## Communication with M-Bus

| Byte No. | Size | Value       | Description  |
|----------|------|-------------|--|
| 1        | 1    | 68          | Start character                                    |
| 2        | 1    | 4B          | L-field, calculated from C field to last user data |
| 3        | 1    | 4B          | L-field, repeated                                  |
| 4        | 1    | 68          | Start character                                    |
| 5        | 1    | 08          | C-field, RSP_UD                                    |
| 6        | 1    | xx          | A-field, address                                   |
| 7        | 1    | 72          | CI-field, variable data respond, LSB first         |
| 8-11     | 4    | xxxxxxx     | Identification Number, 8 BCD digits                |
| 12-13    | 2    | 4204        | Manufacturer: ABB                                  |
| 14       | 1    | 02          | Version  |
| 15       | 1    | 02          | Medium, 02 = Electricity                           |
| 16       | 1    | xx          | Number of accesses                                 |
| 17       | 1    | xx          | Status   |
| 18-19    | 2    | 0000        | Signature (0000 = no encryption)                   |
| 20       | 1    | CE          | DIF size, 12 digit BCD, storage number bit 0       |
| 21       | 1    | 00          | DIFE, storage number bit 1-4                       |
| 22       | 1    | ED          | VIF for time/date point                            |
| 23       | 1    | E8          | VIFE indicating end of period                      |
| 24       | 1    | xx          | VIFE status  |
| 25-30    | 6    | xxxxxxxxxxx | Time and date (sec,min,hour,day,month,year)        |
| 31       | 1    | CE          | DIF size, 12 digit BCD, storage number bit 0       |
| 32       | 1    | 40          | DIFE, storage number bit 1-4, unit bit 0           |
| 33       | 1    | FD          | VIF FD -> next VIFE specifies type of value        |
| 34       | 1    | 61          | Cumulation counter                                 |
| 35       | 1    | xx          | VIFE status  |
| 36-41    | 6    | xxxxxxxxxxx | Number of pulses registered on input 1             |
| 42       | 1    | CE          | DIF size, 12 digit BCD, storage number bit 0       |
| 43       | 1    | 80          | DIFE, storage number bit 1-4, unit bit 0           |
| 44       | 1    | 40          | DIFE, unit bit 1                                   |
| 45       | 1    | FD          | VIF FD -> next VIFE specifies type of value        |
| 46       | 1    | 61          | Cumulation counter                                 |
| 47       | 1    | xx          | VIFE status  |
| 48-53    | 6    | xxxxxxxxxxx | Number of pulses registered on input 2             |
| 54       | 1    | CE          | DIF size, 12 digit BCD, storage number bit 0       |
| 55       | 1    | C0          | DIFE, storage number bit 1-4, unit bit 0           |
| 56       | 1    | 40          | DIFE, unit bit 1                                   |
| 57       | 1    | FD          | VIF FD -> next VIFE specifies type of value        |
| 58       | 1    | 61          | Cumulation counter                                 |
| 59       | 1    | xx          | VIFE status  |
| 60-65    | 6    | xxxxxxxxxxx | Number of pulses registered on input 3             |
| 66       | 1    | CE          | DIF size, 12 digit BCD, storage number bit 0       |

| Byte No. | Size | Value       | Description                                       |
|----------|------|-------------|---|
| 67       | 1    | 80          | DIFE, storage number bit 1-4, unit bit 0          |
| 68       | 1    | 80          | DIFE, unit bit 1                                  |
| 69       | 1    | 40          | DIFE, unit bit 2                                  |
| 70       | 1    | FD          | VIF FD -> next VIFE specifies type of value       |
| 71       | 1    | 61          | Cumulation counter                                |
| 72       | 1    | xx          | VIFE status                                       |
| 73-78    | 6    | xxxxxxxxxxx | Number of pulses registered on input 4            |
| 79       | 1    | 0F          | DIF indicating that this is the last telegram     |
| 80       | 1    | xx          | CS checksum, calculated from C field to last data |
| 81       | 1    | 16          | Stop character                                    |

## 10.4 Special Readout of Meter Data

### Introduction

Some data in the meter can only be read by first sending a SND\_UD followed by a REQ\_UD2.



**Note** – An NKE should always be sent before sending any of the commands described below. If the meter is in the middle of another special data readout process it will not respond correctly to the command.

After reading the first telegram, it is possible to continue reading by sending repeated REQ\_UD2 commands

If the data item that has been read is normal and without any specific status associated with it, no status-VIFE or 0 will be sent out. If the status is “data error” or “no data available”, the standard M-Bus status coding will be sent out (18 hex or 15 hex).

### Readable data

The data that can be read in this way is:

- Load profile
- Demand
- Previous values
- Logs
- Harmonics

### Date, date/time format

In some cases data specifying date or date/time is contained in the read request command.

The format for date used in the commands is M-Bus data type G:

|  |                   |
|--|-------------------|
| Day in bits 0-4  | Valid values 1-31 |
| Months in bits 8-11                                    | Valid values 1-12 |
| Year in bits 5-7 and 12-15 (bits 5-7 are the LSB bits) | Valid values 1-99 |

The format for date/time is 6 bytes BCD or M-Bus data type F. M-Bus data type F consists of

|   |                   |
|---|-------------------|
| Minutes in bits 0-5                     | Valid values 0-59 |
| Hours in bits 8-12                      | Valid values 0-23 |
| Day in bits 16-20                       | Valid values 1-31 |
| Months in bits 24-27                    | Valid values 1-12 |
| Year in bits 21-23 and 28-31 (MSB bits) | Valid values 0-99 |

If a date or date/time is specified in the command, the meter sends out data for that period. If no data is stored in the meter for the specified period, the meter will

send out data from the nearest date backward in time. Therefore it is recommended that the system should check the date sent in the telegram to verify that it is the requested date. If no data is stored in the meter for the specified date, or for any date backward in time, the telegram will contain no load profile data (only the interval length).

### 10.4.1 Readout of Load Profile Data

#### Read request for a specified date and quantity

A read request for a specified date and quantity is performed by sending the following SND\_UD to the meter followed by a REQ\_UD2 (all values are hexadecimal).

| Byte No. | Size | Value | Description  |
|----------|------|-------|--|
| 1        | 1    | 68    | Start character  |
| 2        | 1    | 0A    | L-field, calculated from C field to last user data   |
| 3        | 1    | 0A    | L-field, repeated  |
| 4        | 1    | 68    | Start character  |
| 5        | 1    | 53/73 | C-field, SND_UD  |
| 6        | 1    | xx    | A-field, address   |
| 7        | 1    | 51    | CI-field, data send, LSB first   |
| 8        | 1    | 02    | DIF size, 2 byte integer   |
| 9        | 1    | EC    | VIF time point, date, M-Bus data type G  |
| 10       | 1    | FF    | VIFE next byte is manufacturer specific  |
| 11       | 1    | F9    | VIFE extension of manufacturer specific VIFE's, next VIFE specifies actual meaning.  |
| 12       | 1    | xx    | VIFE specifies data requested:<br>10: Active import energy register values at end of interval<br>12: Reactive import energy register values at end of interval<br>14: Input 1 register values at end of interval<br>16: Input 2 register values at end of interval<br>1C: Active export energy register values at end of interval<br>1E: Reactive export energy register values at end of interval<br>20: Apparent import energy register values at end of interval<br>22: Apparent export energy register values at end of interval<br>24: Input 3 register values at end of interval<br>26: Input 4 register values at end of interval<br>28: Current average values per interval<br>29: Voltage average values per interval<br>2A: THD voltage average values per interval<br>2B: THD current average values per interval<br>2C: Power factor average values per interval |
| 13-14    | 2    | xxxx  | Date (M-Bus data type G, LSB byte sent first)  |
| 15       | 1    | xx    | CS checksum, calculated from C field to last data  |
| 16       | 1    | 16    | Stop character   |

### Read request for a specified date and channel number

A read request for a specified date and channel number is performed by sending the following SND\_UD to the meter followed by a REQ\_UD2 (all values are hexadecimal).

| Byte No. | Size | Value | Description   |
|----------|------|-------|---|
| 1        | 1    | 68    | Start character   |
| 2        | 1    | 0D    | L-field, calculated from C field to last user data                                  |
| 3        | 1    | 0D    | L-field, repeated   |
| 4        | 1    | 68    | Start character   |
| 5        | 1    | 53/73 | C-field, SND_UD   |
| 6        | 1    | xx    | A-field, address  |
| 7        | 1    | 51    | CI-field, data send, LSB first  |
| 8        | 1    | 02    | DIF size, 2 byte integer  |
| 9        | 1    | EC    | VIF time point, date, M-Bus data type G   |
| 10       | 1    | FF    | VIFE next byte is manufacturer specific   |
| 11       | 1    | F9    | VIFE extension of manufacturer specific VIFE's, next VIFE specifies actual meaning. |
| 12       | 1    | B8    | VIFE specifying readout based on channel number                                     |
| 13       | 1    | FF    | VIFE next byte is manufacturer specific   |
| 14       | 1    | xx    | VIFE specifying data channel number   |
| 15-16    | 2    | xxxx  | Date (M-Bus data type G, LSB byte sent first)                                       |
| 17       | 1    | xx    | CS checksum, calculated from C field to last data                                   |
| 18       | 1    | 16    | Stop character  |

### Read request for a specified date, time and quantity

A read request for a specified date, time and quantity is performed by sending the following SND\_UD to the meter followed by a REQ\_UD2 (all values are hexadecimal).

| Byte No. | Size | Value | Description  |
|----------|------|-------|--|
| 1        | 1    | 68    | Start character                                    |
| 2        | 1    | 0E    | L-field, calculated from C field to last user data |
| 3        | 1    | 0E    | L-field, repeated                                  |
| 4        | 1    | 68    | Start character                                    |
| 5        | 1    | 53/73 | C-field, SND_UD                                    |
| 6        | 1    | xx    | A-field, address                                   |
| 7        | 1    | 51    | CI-field, data send, LSB first                     |
| 8        | 1    | 0E    | DIF size, 12 digit BCD data                        |
| 9        | 1    | ED    | VIF time point, date, M-Bus data type G            |
| 10       | 1    | FF    | VIFE next byte is manufacturer specific            |

| Byte No. | Size | Value       | Description  |
|----------|------|-------------|--|
| 11       | 1    | F9          | VIFE extension of manufacturer specific VIFE's, next VIFE specifies actual meaning.  |
| 12       | 1    | xx          | VIFE specifies data requested:<br>10: Active import energy register values at end of interval<br>12: Reactive import energy register values at end of interval<br>14: Input 1 register values at end of interval<br>16: Input 2 register values at end of interval<br>1C: Active export energy register values at end of interval<br>1E: Reactive export energy register values at end of interval<br>20: Apparent import energy register values at end of interval<br>22: Apparent export energy register values at end of interval<br>24: Input 3 register values at end of interval<br>26: Input 4 register values at end of interval<br>28: Current average values per interval<br>29: Voltage average values per interval<br>2A: THD voltage average values per interval<br>2B: THD current average values per interval<br>2C: Power factor average values per interval |
| 13-18    | 6    | xxxxxxxxxxx | Time/date (sec:min:hour / day-month-year)  |
| 19       | 1    | xx          | CS checksum, calculated from C field to last data  |
| 20       | 1    | 16          | Stop character   |

**Read request for a specified date, time and channel number**

A read request for a specified date, time and channel number is performed by sending the following SND\_UD to the meter followed by a REQ\_UD2 (all values are hexadecimal).

| Byte No. | Size | Value       | Description   |
|----------|------|-------------|---|
| 1        | 1    | 68          | Start character   |
| 2        | 1    | 11          | L-field, calculated from C field to last user data                                  |
| 3        | 1    | 11          | L-field, repeated   |
| 4        | 1    | 68          | Start character   |
| 5        | 1    | 53/73       | C-field, SND_UD   |
| 6        | 1    | xx          | A-field, address  |
| 7        | 1    | 51          | CI-field, data send, LSB first  |
| 8        | 1    | 0E          | DIF size, 12 digit BCD data   |
| 9        | 1    | ED          | VIF time point, date, M-Bus data type G   |
| 10       | 1    | FF          | VIFE next byte is manufacturer specific   |
| 11       | 1    | F9          | VIFE extension of manufacturer specific VIFE's, next VIFE specifies actual meaning. |
| 12       | 1    | B8          | VIFE specifying readout based on channel number.                                    |
| 13       | 1    | FF          | VIFE next byte is manufacturer specific.  |
| 14       | 1    | F8          | VIFE extension of manufacturer specific VIFE's, next VIFE contains number.          |
| 15       | 1    | xx          | VIFE specifies data channel number (1-8).   |
| 16-21    | 6    | xxxxxxxxxxx | Time/date (sec:min:hour / day-month-year)   |

| Byte No. | Size | Value | Description                                       |
|----------|------|-------|---|
| 22       | 1    | xx    | CS checksum, calculated from C field to last data |
| 23       | 1    | 16    | Stop character                                    |

### Read request for specified date, time, quantity and phase number

A read request for a load profile, quantities with phase no. specified is performed by sending the following SND\_UD to the meter followed by a REQ\_UD2 (all values are hexadecimal).

| Byte No. | Size | Value       | Description  |
|----------|------|-------------|--|
| 1        | 1    | 68          | Start character  |
| 2        | 1    | 10          | L-field, calculated from C field to last user data   |
| 3        | 1    | 10          | L-field, repeated  |
| 4        | 1    | 68          | Start character  |
| 5        | 1    | 53/73       | C-field, SND_UD  |
| 6        | 1    | xx          | A-field, address   |
| 7        | 1    | 51          | CI-field, data send, LSB first   |
| 8        | 1    | 0E          | DIF size, 12 digit BCD data  |
| 9        | 1    | ED          | VIF time point, date and time  |
| 10       | 1    | FF          | VIFE specifying next byte is manufacturer specific   |
| 11       | 1    | F9          | VIFE extension of manufacturer specific VIFE's, next VIFE specifies actual meaning.  |
| 12       | 1    | xx          | VIFE specifies data requested:<br>10: Active import energy register values at end of interval<br>12: Reactive import energy register values at end of interval<br>14: Input 1 register values at end of interval<br>16: Input 2 register values at end of interval<br>1C: Active export energy register values at end of interval<br>1E: Reactive export energy register values at end of interval<br>20: Apparent import energy register values at end of interval<br>22: Apparent export energy register values at end of interval<br>24: Input 3 register values at end of interval<br>26: Input 4 register values at end of interval<br>28: Current average values per interval<br>29: Voltage average values per interval<br>2A: THD voltage average values per interval<br>2B: THD current average values per interval<br>2C: Power factor average values per interval |
| 13       | 1    | FF          | VIFE next byte is manufacturer specific  |
| 14       | 1    | xx          | VIFE specifying phase number (L1,L2,L3,L1-L2,L2-L3,L1-L3 or N)   |
| 15-20    | 6    | xxxxxxxxxxx | Time/date (sec:min:hour / day-month-year)  |
| 21       | 1    | xx          | CS checksum, calculated from C field to last data  |
| 22       | 1    | 16          | Stop character   |



**Read request for load profile with channel number specified**

A read request for a load profile with channel no. specified as input is performed by sending the following SND\_UD to the meter followed by a REQ\_UD2 (all values are hexadecimal). Sending no date or date/time will result in that the meter start by sending out the most recent data.

| Byte No. | Size | Value | Description   |
|----------|------|-------|---|
| 1        | 1    | 68    | Start character   |
| 2        | 1    | 0A    | L-field, calculated from C field to last user data                                  |
| 3        | 1    | 0A    | L-field, repeated   |
| 4        | 1    | 68    | Start character   |
| 5        | 1    | 53/73 | C-field, SND_UD   |
| 6        | 1    | xx    | A-field, address  |
| 7        | 1    | 51    | CI-field, data send, LSB first  |
| 8        | 1    | 00    | DIF size, no data   |
| 9        | 1    | FF    | VIF next byte is manufacturer specific  |
| 10       | 1    | F9    | VIFE extension of manufacturer specific VIFE's, next VIFE specifies actual meaning. |
| 11       | 1    | B8    | VIFE specifying reading based upon the channel number                               |
| 12       | 1    | FF    | VIFE next byte is manufacturer specific   |
| 13       | 1    | F8    | VIFE next byte is manufacturer specific, used for numbering                         |
| 14       | 1    | xx    | VIFE specifies channel number (1-8)   |
| 15       | 1    | xx    | CS checksum, calculated from C field to last data                                   |
| 16       | 1    | 16    | Stop character  |

**Comments**

The data is sent out with a number of profile values in each telegram.

The first data item sent out in each telegram is the interval length.

After that the date/time for the end of the interval followed by the data value for that interval is sent out

All load profile energy values and input counters are read as register values, that is snapshots of the register at the end of the interval. All other load profile values, for example voltages, currents, power factors, THD's are read as interval average values.

All load profile values have storage number 1 to indicate that it is stored historical data.

**Status information**

The manufacturer specific coding of the status information is used to indicate the following:

- Date/time was changed during the interval
- Data overflow in interval
- Intervals are too long or too short
- Power outage occurred during the interval

If one or several of these status events occur during an interval, the extra VIFE's FF FE 0x are sent out, where x is a bit 4-0 and have the following meaning if set:

|       |   |
|-------|---|
| Bit 4 | Date/time was changed during the interval |
| Bit 3 | Data overflow in interval                 |
| Bit 2 | Power outage occurred during interval     |
| Bit 1 | Short interval                            |
| Bit 0 | Long interval                             |

---

**10.4.1.1 Examples of Readouts of Load Profile Data**

**Introduction**

In the following are a number of practical examples of load profile readouts. All data is hexadecimal and comments are preceded by a semicolon.

**Readout of two telegrams of active energy import load profile register values**

Sending NKE:

10 40 fe 3e 16

Reading acknowledge:

e5

Sending read request for active energy import with date and time of 20:th of june 2014, 15:00:00

68 0e 0e 68 73 fe 51 0e ed ff f9 10 00 00 15 20 06 14 14 16

Reading acknowledge

e5

Sending Request User Data 2:

10 7b fe 79 16

Reading telegram 1:

68 e6 e6 68 08 00 72 34 12 00 00 42 04 20 02 63 00 00 00;Header Information

01 fd a5 00 3c ;Interval length = 60 minutes

4e ed eb 00 00 00 15 20 06 14 ;Date and time at end of the interval (14-06-20 / 15:00:00)

4e 83 00 02 97 07 92 00 00 ;Total active import energy 92079,702 kWh, status 0

4e ed eb 00 00 00 14 20 06 14 ;Date / time 14-06-20 / 14:00:00

4e 83 00 92 86 07 92 00 00 ;Total active import energy 92078,692 kWh, status 0

4e ed eb 00 00 00 13 20 06 14 ;Date / time 14-06-20 / 13:00:00

4e 83 00 12 56 05 92 00 00 ;Total active import energy 92055,612 kWh

4e ed eb 00 00 00 12 20 06 14 ;Date / time 14-06-20 / 12:00:00

4e 83 00 57 00 01 92 00 00 ;Total active import energy 92010,057 kWh

4e ed eb 00 00 00 11 20 06 14 ;Date / time 14-06-20 / 11:00:00

4e 8300 47 71 98 91 00 00 ;Total active import energy 91987,147 kWh

4e ed eb 00 00 00 10 20 06 14 ;Date / time 14-06-20 / 10:00:00

4e 83 00 82 34 92 91 00 00 ;Total active import energy 91923,482 kWh

4e ed eb 00 00 00 09 20 06 14 ;Date / time 14-06-20 / 09:00:00

4e 83 00 17 94 88 91 00 00 ;Total active import energy 91889,417 kWh

4e ed eb 00 00 00 08 20 06 14 ;Date / time 14-06-20 / 08:00:00

4e 83 00 07 45 84 91 00 00 ;Total active import energy 91844,507 kWh

4e ed eb 00 00 00 07 20 06 14 ;Date / time 14-06-20 / 07:00:00  
4e 83 00 12 02 82 91 00 00 ;Total active import energy 91820,212 kWh  
4e ed eb 00 00 00 06 20 06 14 ;Date / time 14-06-20 / 06:00:00  
4e 83 00 72 61 77 91 00 00 ;Total active import energy 91776,172 kWh  
4e ed eb 00 00 00 05 20 06 14 ;Date / time 14-06-20 / 05:00:00  
4e 83 00 12 79 74 91 00 00 ;Total active import energy 91747,912 kWh  
1f ;Dif 1f, there are more data to read out  
73 16 ; Checksum and stop byte

Sending Request User Data 2:

10 5b fe 59 16

Reading telegram 2:

68 e6 e6 68 08 00 72 34 12 00 00 42 04 20 02 64 00 00 00 ;Header Information  
01 fd a5 00 3c ;Interval length = 60 minutes  
4e ed eb 00 00 00 04 20 06 14 Date / time at end of the interval (14-06-20 /  
15:00:00)  
4e 83 00 07 90 70 91 00 00 ;Total active import energy 91709,007 kWh, status 0  
4e ed eb 00 00 00 03 20 06 14 ;Date / time 14-06-20 / 03:00:00  
4e 83 00 92 13 60 91 00 00 ;Total active import energy 91601,392 kWh  
4e ed eb 00 00 00 02 20 06 14 ;Date / time 14-06-20 / 02:00:00  
4e 83 00 07 09 48 91 00 00 ;Total active import energy 91480,907 kWh  
4e ed eb 00 00 00 01 20 06 14 ;Date / time 14-06-20 / 01:00:00  
4e 83 00 97 28 37 91 00 00 ;Total active import energy 91372,897 kWh  
4e ed eb 00 00 00 00 20 06 14 ;Date / time 14-06-20 / 00:00:00  
4e 83 00 57 40 29 91 00 00 ;Total active import energy 91294,057 kWh  
4e ed eb 00 00 00 23 19 06 14 ;Date / time 14-06-19 / 23:00:00  
4e 83 00 97 78 16 91 00 00 ;Total active import energy 91167,897 kWh  
4e ed eb 00 00 00 22 19 06 14 ;Date / time 14-06-19 / 22:00:00  
4e 83 00 97 80 07 91 00 00 ;Total active import energy 91078,097 kWh  
4e ed eb 00 00 00 21 19 06 14 ;Date / time 14-06-19 / 21:00:00  
4e 83 00 02 56 98 90 00 00 ;Total active import energy 90985,602 kWh  
4e ed eb 00 00 00 20 19 06 14 ;Date / time 14-06-19 / 20:00:00  
4e 83 00 32 54 89 90 00 00 ;Total active import energy 90895,432 kWh  
4e ed eb 00 00 00 19 19 06 14 ;Date / time 14-06-19 / 19:00:00  
4e 83 00 82 04 75 90 00 00 ;Total active import energy 90750,482 kWh  
4e ed eb 00 00 00 18 19 06 14 ;Date / time 14-06-19 / 18:00:00  
4e 83 00 02 71 66 90 00 00 ;Total active import energy 90667,102 kWh  
1f ;Dif 1f, there are more data to read out  
a3 16 ; Checksum and stop byte

### 10.4.2 Readout of Demand Data

**Read request**

A read request is performed by sending the following SND\_UD to the meter followed by a REQ\_UD2 (all values are hexadecimal).

| Byte No. | Size | Value | Description  |
|----------|------|-------|--|
| 1        | 1    | 68    | Start character  |
| 2        | 1    | 0A    | L-field, calculated from C field to last user data                                 |
| 3        | 1    | 0A    | L-field, repeated  |
| 4        | 1    | 68    | Start character  |
| 5        | 1    | 53/73 | C-field, SND_UD  |
| 6        | 1    | xx    | A-field, address   |
| 7        | 1    | 51    | CI-field, data send, LSB first   |
| 8        | 1    | 02    | DIF size, 2 byte integer   |
| 9        | 1    | EC    | VIF time point, date, M-Bus data type G  |
| 10       | 1    | FF    | VIF next byte is manufacturer specific   |
| 11       | 1    | F9    | VIF extension of manufacturer specific VIFE's, next VIFE specifies actual meaning. |
| 12       | 1    | 18    | VIFE specifies maximum demand  |
| 13-14    | 2    | xxxx  | Date (M-Bus data type G, LSB byte sent first)                                      |
| 15       | 1    | xx    | CS checksum, calculated from C field to last data                                  |
| 16       | 1    | 16    | Stop character   |

**Comments**

The demand data stored for a measured period is sent out in one or more telegrams depending on the number of channels that are used. The data that is sent out is interval and subinterval length, demand values for all channels and a date/time stamp for the end of the measured period. Each demand value is also followed by the date/time stamp for the end of the interval in which the minimum/maximum occurred.

The date/time information is sent out in format 6 byte BCD in order second, minute, hour, day, month and year.

The data for the currently pending period will be sent out with storage number set to 0, the most recent stored historical values will have storage number 1, the next set of historical values will have storage number 2 etc.

If data have not been generated for a quantity the demand value is set to 0 and status “data not available” (15 hex) and the date/time is set to 00-01-01 / 00:00:00. This is the case for the currently pending period before any demand have been stored, that is while the very first interval in a measurement period is pending. It will also happen if a particular tariff has not been active in a measurement period.

### 10.4.2.1 Examples of Readouts of Demand Data

---

#### Introduction

In the following is a number of commented practical examples of demand data. All data is in hexadecimal format. Comments are preceded by a semicolon.

Minimum values have the function field in the DIF set to 10 hex and maximum values 01 hex.

---

#### Readout of demand data

System sends read request command for demand with date 14-08-17:

68 0A 0A 68 73 FE 51 02 EC FF F9 18 D1 18 A9 16

Meter sends out acknowledge:

E5

System sends out request UD2:

10 7B FE 79 16

Meter sends out data telegram 1:

68 CE CE 68 08 00 72 34 12 00 00 42 04 20 02 B2 00 00 00 ;Data header

01 FD A5 00 0F ;Interval length 15 minutes

01 FF AB 00 01 ;Subinterval length 1 minute

14 A9 FF F9 D1 00 66 33 00 00 ;Current demand (storage number 0) for 1:st maximum total active power import, VIF A9 -> data in W with 2 decimals. Data = 00003366 hex = 131.58 W

0E ED EB 00 00 15 00 16 08 14 ;Date/time stamp for maximum given above: 16:th of august 2014, 00:15:00 (hour:minute:second)

14 A9 FF F9 D2 00 6A 02 00 00 ;Current demand (storage number 0) for 2:nd maximum total active power import, VIF A9 -> data in W with 2 decimals. Data = 0000026A hex = 6.18 W

0E ED EB 00 00 30 00 16 08 14 ;Date/time stamp for maximum given above: 16:th of august 2014, 00:30:00 (hour:minute:second)

14 A9 FF F9 D3 15 00 00 00 00 ;Current demand (storage number 0) for 3:rd maximum total active power import, status 15 hex -> no data available (data set to 0 when not available)

0E ED EB 00 00 00 00 01 01 00 ;Date/time stamp for maximum given above: Set to 1:st of january 2000, 00:00:00 when data not available

24 A9 FF F9 D9 00 8C 01 00 00 ;Current demand (storage number 0) for 1:st minimum total active power import, VIF A9 -> data in W with 2 decimals. Data = 0000018C hex = 3.96 W

0E ED EB 00 00 28 00 16 08 14 ;Date/time stamp for minimum given above: 16:th of august 2014, 00:28:00 (hour:minute:second)

94 80 40 A9 FF F9 D9 00 70 08 00 00 ;Current demand (storage number 0) for 1:st maximum sliding total reactive power import, VIF A9 -> data in var with 2 decimals. Data = 00000870 hex = 21.60 var

0E ED EB 00 00 42 00 16 08 14 ;Date/time stamp for maximum given above: 16:th of august 2014, 00:42:00

94 80 40 A9 FF F9 DA 00 80 07 00 00 ;Current demand (storage number 0) for 2:nd maximum sliding total reactive power import, Data = 00000780 hex = 19.20 var

0E ED EB 00 00 41 00 16 08 14 ;Date/time stamp for maximum given above: 16:th of august 2014, 00:41:00

94 80 40 A9 FF F9 DB 00 78 06 00 00;Current demand (storage number 0) for 3:rd maximum sliding total reactive power import, Data = 00000678 hex = 16.56 var

0E ED EB 00 00 40 00 16 08 14 ;Date/time stamp for maximum given above: 16:th of august 2014, 00:40:00

A4 80 40 A9 FF F9 D1 00 00 00 00 00 ;Current demand (storage number 0) for 1:st minimum total reactive power import, Data = 0 var

0E ED EB 00 00 15 00 16 08 14 ;Date/time stamp for minimum given above: 16:th of august 2014, 00:15:00

0E ED EB FF F0 00 04 42 00 16 08 14 ;Date/time stamp for end of measurement period. Will always be current date and time for the currently pending period, in this case 16:th of august 2014, 00:42:04

1F ;Dif 1F -> More data exists

13 16 ;Checksum and stop byte

System sends out request UD2:

10 5B FE 59 16

Meter sends out data telegram 2:

68 C6 C6 68 08 00 72 34 12 00 00 42 04 20 02 B3 00 00 00 ;Data header

01 FD A5 00 0F ;Interval length 15 minutes

01 FF AB 00 01 ;Subinterval length 1 minute

94 80 80 40 A9 FF F9 D1 00 34 35 00 00 ;Current demand (storage number 0) for 1:st maximum total apparent power import, VIF A9 -> data in VA with 2 decimals. Data = 00003534 hex = 136.20 VA

0E ED EB 00 00 15 00 16 08 14 ;Date/time stamp for maximum given above: 16:th of august 2014, 00:15:00

14 A9 FF 81 FF F9 D1 00 40 11 00 00 ;Current demand (storage number 0) for 1:st maximum L1 active power import, VIF A9 -> data in VA with 2 decimals. Data = 1140hex = 44.16 W

0E ED EB 00 00 15 00 16 08 14 ;Date/time stamp for maximum given above: 16:th of august 2014, 00:15:00

14 FD C8 FF 81 FF F9 D1 00 97 07 00 00 ;Current demand (storage number 0) for 1:st maximum L1-N voltage, VIF C8 -> data in V with 1 decimal. Data = 797hex = 194.3 V

0E ED EB 00 00 30 00 16 08 14 ;Date/time stamp for maximum given above: 16:th of august 2014, 00:30:00

12 FF EE FF 81 FF F8 80 FF F9 D1 00 0D 00 ;Current demand (storage number 0) for 1:st maximum L1-N voltage THD (given in % with 1 decimal). Data = Dhex = 1.3 %

0E ED EB 00 00 15 00 16 08 14 ;Date/time stamp for maximum given above: 16:th of august 2014, 00:15:00

14 FD D9 FF 81 FF F9 D9 00 F1 00 00 00 ;Current demand (storage number 0) for 1:st maximum sliding L1 current. VIFE D9 -> data in A with 3decimals. Data = F1hex = 0.241 A

0E ED EB 00 00 15 00 16 08 14 ;Date/time stamp for maximum given above: 16:th of august 2014, 00:15:00

12 FF ED FF 81 FF F8 80 FF F9 D1 00 7E 00 ;Current demand (storage number 0) for 1:st maximum L1 current THD (given in % with 1 decimal). Data = 7Ehex = 12.6 %

0E ED EB 00 00 15 00 16 08 14 ;Date/time stamp for maximum given above: 16:th of august 2014, 00:15:00

94 10 A9 FF F9 D1 00 66 33 00 00 ;Current demand (storage number 0) for 1:st maximum active T1 power. VIFE A9 -> data in W with 2 decimals. Data = 3366hex = 131.58 W

0E ED EB 00 00 15 00 16 08 14 ;Date/time stamp for maximum given above: 16:th of august 2014, 00:15:00

0E ED EB FF F0 00 05 42 00 16 08 14 ;Date/time stamp for end of measurement period. Will always be current date and time for the currently pending period, in this case 16:th of august 2014, 00:42:05



1F ;Dif 1F -> More data exists

A5 16 ;Checksum and stop byte

System sends out request UD2:

10 7B FE 79 16

Meter sends out data telegram 3:

68 54 54 68 08 00 72 34 12 00 00 42 04 20 02 B4 00 00 00 ;Data header

01 FD A5 00 0F ;Interval length 15 minutes

01 FF AB 00 01 ;Subinterval length 1 minute

94 20 A9 FF F9 D1 00 00 00 00 00 ;Current demand (storage number 0) for 1:st maximum active T2 power. VIFE A9 -> data in W with 2 decimals. Data = 0 W

0E ED EB 00 00 15 00 16 08 14 ;Date/time stamp for maximum given above: 16:th of august 2014, 00:15:00

9E 40 FD E1 A2 FF F9 D9 00 24 05 00 00 00 00 ;Current demand (storage number 0) for 1:st maximum input 1 counter sliding demand. Data = 524hex = 524 pulses per hour

0E ED EB 00 00 34 00 16 08 14 ;Date/time stamp for maximum given above: 16:th of august 2014, 00:34:00

0E ED EB FF F0 00 06 42 00 16 08 14 ;Date/time stamp for end of measurement period. Will always be current date and time for the currently pending period, in this case 16:th of august 2014, 00:42:06

1F ;Dif 1F -> More data exists

9F 16 ;Checksum and stop byte

System sends out request UD2:

10 5B FE 59 16

Meter sends out data telegram 4:

68 CE CE 68 08 00 72 34 12 00 00 42 04 20 02 B5 00 00 00 ;Data header

01 FD A5 00 0F ;Interval length 15 minutes

01 FF AB 00 01 ;Subinterval length 1 minute

54 A9 FF F9 D1 00 2C 3D 00 00 ;Demand with storage number 1 for 1:st maximum total active power import, VIF A9 -> data in W with 2 decimals. Data = 3D2C hex = 156.60 W

4E ED EB 00 00 45 23 15 08 14 ;Date/time stamp for maximum given above: 15:th of august 2014, 23:45:00

The rest of the data in telegram 4-6 (followed below) will contain the same quantities as telegram 1-3 but with the storage number 1

54 A9 FF F9 D2 00 3A 23 00 00

4E ED EB 00 00 00 14 15 08 14

54 A9 FF F9 D3 00 1C 17 00 00

4E ED EB 00 00 15 14 15 08 14

64 A9 FF F9 D9 00 B2 14 00 00

4E ED EB 00 00 46 13 15 08 14

D4 80 40 A9 FF F9 D9 00 BE 17 00 00

4E ED EB 00 00 54 13 15 08 14

D4 80 40 A9 FF F9 DA 00 70 17 00 00

4E ED EB 00 00 55 13 15 08 14

D4 80 40 A9 FF F9 DB 00 34 17 00 00

4E ED EB 00 00 53 13 15 08 14

E4 80 40 A9 FF F9 D1 00 00 00 00 00

4E ED EB 00 00 45 23 15 08 14

4E ED EB FF F0 15 00 00 00 16 08 14

1F

E5 16

System sends out request UD2:

10 7B FE 79 16

Meter sends out data telegram 5:

68 C6 C6 68 08 00 72 34 12 00 00 42 04 20 02 B6 00 00 00

01 FD A5 00 0F

01 FF AB 00 01

D4 80 80 40 A9 FF F9 D1 00 B8 3E 00 00

4E ED EB 00 00 45 23 15 08 14

54 A9 FF 81 FF F9 D1 00 88 14 00 00

4E ED EB 00 00 45 23 15 08 14

54 FD C8 FF 81 FF F9 D1 00 6B 08 00 00

4E ED EB 00 00 00 14 15 08 14

52 FF EE FF 81 FF F8 80 FF F9 D1 00 0E 00

4E ED EB 00 00 45 23 15 08 14  
 54 FD D9 FF 81 FF F9 D9 00 19 01 00 00  
 4E ED EB 00 00 45 23 15 08 14  
 52 FF ED FF 81 FF F8 80 FF F9 D1 00 97 00  
 4E ED EB 00 00 45 23 15 08 14  
 D4 10 A9 FF F9 D1 00 2C 3D 00 00  
 4E ED EB 00 00 45 23 15 08 14  
 4E ED EB FF F0 15 00 00 00 16 08 14  
 1F  
 C5 16

System sends out request UD2:

10 5B FE 59 16

Meter sends out data telegram 6:

68 54 54 68 08 00 72 34 12 00 00 42 04 20 02 B7 00 00 00  
 01 FD A5 00 0F  
 01 FF AB 00 01  
 D4 20 A9 FF F9 D1 00 3A 23 00 00  
 4E ED EB 00 00 00 14 15 08 14  
 DE 40 FD E1 A2 FF F9 D9 00 44 02 00 00 00 00  
 4E ED EB 00 00 46 13 15 08 14  
 4E ED EB FF F0 00 00 00 00 16 08 14  
 0F ;Dif 0F -> No more data exists  
 26 16

### 10.4.3 Readout of Previous Values

#### Read request

A read request is performed by sending the following SND\_UD to the meter (all values are hexadecimal) followed by a REQ\_UD2

| Byte No. | Size | Value | Description  |
|----------|------|-------|--|
| 1        | 1    | 68    | Start character                                    |
| 2        | 1    | 0A    | L-field, calculated from C field to last user data |
| 3        | 1    | 0A    | L-field, repeated                                  |
| 4        | 1    | 68    | Start character                                    |
| 5        | 1    | 53/73 | C-field, SND_UD                                    |
| 6        | 1    | xx    | A-field, address                                   |

| Byte No. | Size | Value | Description   |
|----------|------|-------|---|
| 7        | 1    | 51    | CI-field, data send, LSB first  |
| 8        | 1    | 02    | DIF size, 2 byte integer  |
| 9        | 1    | EC    | VIF time point, date, M-Bus data type G   |
| 10       | 1    | FF    | VIF next byte is manufacturer specific  |
| 11       | 1    | F9    | VIF extension of manufacturer specific VIFEs, next VIFE specifies actual meaning. |
| 12       | 1    | 19    | VIFE specifies Previous values  |
| 13-14    | 2    | xxxx  | Date (M-Bus data type G, LSB byte sent first)                                     |
| 15       | 1    | xx    | CS checksum, calculated from C field to last data                                 |
| 16       | 1    | 16    | Stop character  |

### Comments

Previous values data for all channels that is stored at the end of a period is sent out in one or more telegrams depending on the number of channels that are used. The most recent values are sent out first having storage number 1, then the second most recently stored values with storage number 2 and so on until all stored previous values have been read. Beside the previous register values a date/time stamp for the end of the period is sent out in the telegram. The date/time information is sent out in format 6 byte BCD in order second, minute, hour, day, month and year.



**Note** – Previous values are also sent out in a normal readout sequence. This sequence takes it start after the default telegrams that contain current values of energy registers, instrumentation values, etc...

---

### 10.4.3.1 Examples of Readouts of Previous Values

---

#### Readout of previous values data

Sending initialize command

10 40 fe 3e 16

Reading acknowledge

e5

System sends read request command for demand with date 11-01-08

68 0a 0a 68 73 fe 51 02 ec ff f9 19 68 11 3a 16 ; Date 8th January, year 11

Reading acknowledge

e5

System sending Request User Data 2:

10 7b fe 79 16

Meter sends out data telegram 1:

68 e3 e3 68 08 00 72 00 00 00 00 42 04 10 02 01 2a 00 00; Data header

ce 00 ed eb 00 00 00 00 08 01 11; Date/Time stamp for previous values, here 08-01-11 / 00:00:00 (day-month-year / sec:min:hour)

ce 00 84 00 39 58 17 00 00 00; Daily value for total import active energy, here 1758.39 kwh

ce 40 84 00 35 18 27 01 00 00; Daily value for total export active energy, here 12718.35 kwh

ce 80 40 84 00 23 75 02 00 00 00; Daily value for total import reactive energy, here 275.23 kvarh

ce c0 40 84 00 35 02 00 00 00 00; Daily value for total export reactive energy, here 2.35 kvarh

ce 00 84 ff 81 00 27 83 75 07 00 00; Daily value for active energy import L1, here 77583.27 kwh

ce 00 84 ff 82 00 23 75 02 00 00 00; Daily value for active energy import L2, here 275.23 kwh

ce 00 84 ff 83 00 35 02 00 00 00 00; Daily value for active energy import L3, here 2.35 kwh

ce 40 84 ff 81 00 39 58 17 00 00 00; Daily value for active energy export L1, here 1758.39 kwh

ce 40 84 ff 82 00 35 18 27 01 00 00; Daily value for active energy export L2, here 12718.35 kwh

ce 40 84 ff 83 00 27 83 75 07 00 00; Daily value for active energy export L3, here 77583.27 kwh

ce 10 84 00 00 00 00 00 00 00; Daily value for tariff 1 active energy, here 0.0 kwh

ce 20 84 00 00 00 00 00 00 00; Daily value for tariff 2 active energy, here 0.0 kwh

ce b0 00 84 00 00 00 00 00 00 00; Daily value for tariff 3 active energy, here 0.0 kwh

ce 80 10 84 00 00 00 00 00 00 00; Daily value for tariff 4 active energy, here 0.0 kwh

ce 90 40 84 00 00 00 00 00 00 00; Daily value for tariff 1 reactive energy, here 0.0 kvarh

ce a0 40 84 00 00 00 00 00 00 00; Daily value for tariff 2 reactive energy, here 0.0 kvarh

ce b0 40 84 00 00 00 00 00 00 00; Daily value for tariff 3 reactive energy, here 0.0 kvarh

ce 80 50 84 00 00 00 00 00 00 00; Daily value for tariff 4 reactive energy, here 0.0 kvarh

1f; Dif 1F-> more daily values exist

6e 16; Checksum and stop byte

System sending Request User Data 2:

10 5b fe 59 16

Meter sends out data telegram 2:

68 4b 4b 68 08 00 72 00 00 00 00 42 04 10 02 02 2a 00 00; Data header

ce 00 ed eb 00 00 00 00 08 01 11; Date/Time stamp for previous values, here 08-01-11 / 00:00:00 (day-month-year / sec:min:hour)

ce 40 fd e1 00 00 00 00 00 00 00; Daily value for input 1 counter, here 0 pulses

ce 80 40 fd e1 00 00 00 00 00 00 00; Daily value for input 1 counter, here 0 pulses

ce c0 40 fd e1 00 00 00 00 00 00 00; Daily value for input 1 counter, here 0 pulses

ce 80 80 40 fd e1 00 00 00 00 00 00 00; Daily value for input 1 counter, here 0 pulses

0f; Dif 0F-> no more daily values exist

cd 16 ; Checksum and stop byte

**Readout of previous values data**

System sends read request command for previous values with date 1:st of july 06:

68 0A 0A 68 73 FE 51 02 EC FF F9 19 C1 07 89 16

Meter sends out acknowledge:

E5

System sends out request UD2:

10 7B FE 79 16

Meter sends out data telegram:

68 85 85 68 08 00 72 44 47 24 00 42 04 02 02 09 00 00 00 ;Data header

The date/time stamp and the monthly values have storage number 1, that is, it is the 1:st (most recent in time) set of monthly values read out

CE 00 ED 6B 00 00 00 01 07 06 ;Date/time stamp for previous values, here 01-07-06 / 00:00:00 (day-month-year / sec:min:hour)

CE 00 04 35 08 00 00 00 00 ;Monthly value for total active energy, 8.35 kWh

CE 10 04 62 02 00 00 00 00 ;Monthly value for tariff 1 active energy, 2.62 kWh

CE 20 04 27 02 00 00 00 00 ;Monthly value for tariff 2 active energy, 2.27 kWh

CE 30 04 79 00 00 00 00 00 ;Monthly value for tariff 3 active energy, 0.79 kWh

CE 80 10 04 65 02 00 00 00 ;Monthly value for tariff 4 active energy, 2.65 kWh

CE 80 40 04 04 02 00 00 00 ;Monthly value for total reactive energy, 2.04 kvarh

CE 90 40 04 64 00 00 00 00 ;Monthly value for tariff 1 reactive energy, 0.64 kWh

CE B0 40 04 19 00 00 00 00 ;Monthly value for tariff 3 reactive energy, 0.19 kWh

CE 80 50 04 65 00 00 00 00 ;Monthly value for tariff 4 reactive energy, 0.65 kWh

CE 40 FD 61 00 00 00 00 00 ;Monthly value for input 1 counter, 0 pulses

CE 80 40 FD 61 00 00 00 00 00 ;Monthly value for input 2 counter, 0 pulses

1F ;Dif 1F -> more monthly values exist

62 16 ;Checksum and stop byte

System sends out request UD2:

10 5B FE 59 16

Meter sends out data telegram:

```

68 8F 8F 68 08 00 72 44 47 24 00 42 04 02 02 0A 00 00 00
8E 01 ED 6B 00 00 00 01 06 06 ;Date/time stamp for previous values, 01-06-
06 / 00:00:00 (day-month-year / sec:min:hour)
8E 01 04 17 05 00 00 00 00 8E 11 04 55 01 00 00 00 00 8E 21 04 27
02 00 00 00 00 8E 31 04 31 00 00 00 00 00 8E 81 10 04 04 01 00 00
00 00 8E 81 40 04 26 01 00 00 00 00 8E 91 40 04 38 00 00 00 00 00
8E A1 40 04 55 00 00 00 00 8E B1 40 04 07 00 00 00 00 8E 81
50 04 25 00 00 00 00 00 8E 41 FD 61 00 00 00 00 00 8E 81 40 FD
61 00 00 00 00 00 00 0F E9 16
    
```

---

### 10.4.4 Readout of Event Log Data

**Read request**

Each one of the existing logs can be read by sending the following SND\_UD to the meter followed by a REQ\_UD2 (all values are hexadecimal).

| Byte No. | Size | Value       | Description   |
|----------|------|-------------|---|
| 1        | 1    | 68          | Start character   |
| 2        | 1    | 12          | L-field, calculated from C field to last user data  |
| 3        | 1    | 12          | L-field, repeated   |
| 4        | 1    | 68          | Start character   |
| 5        | 1    | 53/73       | C-field, SND_UD   |
| 6        | 1    | xx          | A-field, address  |
| 7        | 1    | 51          | CI-field, data send, LSB first  |
| 8        | 1    | 8E or EC    | DIF size, 6 byte BCD, storage number bit 0 is 0 or 1  |
| 9        | 1    | 8x or Cx    | DIFE storage number bits 1-4, unit bit 6 is 0 or 1  |
| 10       | 1    | 8x          | DIFE storage number bits 5-8  |
| 11       | 1    | 8x          | DIFE storage number bits 9-12   |
| 12       | 1    | 0x          | DIFE storage number bits 13-16  |
| 13       | 2    | ED          | VIF time/date   |
| 14       | 1    | FF          | VIF next byte is manufacturer specific  |
| 15       | 1    | F9          | VIF extension of manufacturer specific VIFE's, next VIFE specifies actual meaning.                        |
| 16       | 1    | 1A          | VIFE Specification for different Logs:<br>System Log = 0x2e<br>Net Quality Log = 0x30<br>Event Log = 0x32 |
| 17-22    | 6    | xxxxxxxxxxx | Time/date (sec:min:hour / day-month-year)   |
| 23       | 1    | xx          | CS checksum, calculated from C field to last data   |
| 24       | 1    | 16          | Stop character  |

**Event Offset**

The meter supports offset values 0 and -1 for reading the System, Event, Net Quality logs. If the offset mentioned is 0 then meter will read the log in the for-



ward direction. If the offset value mentioned is -1 then it will read the data in the backward direction from the given date.

---

### Data

The data will be sent out with 5 events in each telegram. If less than 5 events is stored in the meter for the specified date/time and offset all data in the telegram after the last stored event will have status byte marked as "no data available" (15 hex).

The data sent out for each event is:

- Event type (1 byte binary coded).
  - Date/time stamp for start of the event (6 byte bcd in order sec:min:hour/day:month:year)
  - Duration of the event (in seconds)
-

### 10.4.4.1 Example of readout of log data

---

#### Readout of Net Quality Log with date and time specified as input

Send Nke.

10 40 fe 3e 16

Meter Responds with E5

E5

Read request net quality log with Offset -1.

68 12 12 68 73 fe 51 ce c0 80 80 00 ed ff f9 30 01 02 03 22 12 11 b0 16;Read net quality log with offset value -1. Date and Time spciefied as input, 22-12-2011 01:02:03

Meter Responds with E5.

E5.

Send Req UD2.

10 7B FE 79 16.

Meter responds with long frame data for net quality Log:

68 88 88 68 08 00 72 00 00 00 00 42 04 20 02 16 2a 00 00 ; Header Information

02 ff f9 b5 00 e1 07;Event Type net quality Log

0e ed b9 00 21 47 23 06 01 10 ;Date and Time 10.01.06 23:47:21

04 a0 00 dd 03 00 00 ;Duration

02 ff f9 b5 00 de 07 ;Event Type net quality Log

0e ed b9 00 21 47 23 06 01 10 ;Date and Time 10.02.06 23:47:21

04 a0 00 dd 03 00 00 ;Duration

02 ff f9 b5 00 f0 03 ;Event Type net quality Log

0e ed b9 00 11 47 23 06 01 10 ;Date and time 10.02.06 23:47:11

04 a0 00 e7 03 00 00 ;Duration

02 ff f9 b5 00 e8 03

0e ed b9 00 11 47 23 06 01 10

04 a0 00 e7 03 00 00

02 ff f9 b5 00 e2 07

0e ed b9 00 11 47 23 06 01 10

04 a0 e7 03 00 00

1f 70 16;1F indicates there are more frames to follow.

**Readout of 2 telegrams of event log data with offset -1**

System sends event log read request command (date/time 11/12-14 02:03:04),  
offset -1

68 0F 0F 68 73 FE 51 CE 40 ED FF F9 32 04 03 02 11 12 14 27 16

Meter sends out acknowledge:

E5

System sends out request UD2:

10 7B FE 79 16

Meter sends out data telegram:

68 88 88 68 08 00 72 34 12 00 00 42 04 20 02 01 20 00 00 ;Data header

02 FF F9 B7 00 EC 03 ;VIF, VIFE's meaning event type, data contains 03EChex =  
1004 meaning Negative power element 1

0E ED B9 00 53 39 12 22 09 14 14 ;Time/date 53:39:12 / 22-09-14 (sec:min:hour  
/ day-month-year)

04 A0 00 01 00 00 00 ;Duration 1 seconds

02 FF F9 B7 00 EF 03 ;VIF, VIFE's meaning event type, data contains 03EFhex =  
1007 meaning Negative total power

0E ED B9 00 53 39 12 22 09 14 ;Time/date 53:39:22 / 22-09-14 (sec:min:hour /  
day-month-year)

04 A0 00 01 00 00 00 ; Duration 1 seconds

02 FF F9 B7 00 ED 03 ; VIF, VIFE's meaning event type, data contains 03EDhex  
= 1005 meaning Negative power element 2

0E ED B9 00 53 39 12 22 09 14 14 ;Time/date 53:39:12 / 22-09-14 (sec:min:hour  
/ day-month-year)

04 A0 00 C4 00 00 00 ;Duration C4hex = 196 seconds

02 FF F9 B7 00 ED 07 ; VIF, VIFE's meaning event type, data contains 07EDhex  
= 2029 meaning Alarm 17

0E ED B9 00 17 23 10 22 09 14 ;Time/date 17:23:10 / 22-09-14 (sec:min:hour /  
day-month-year)

04 A0 00 4A 00 00 00 ;Duration 4Ahex = 74 seconds

02 FF F9 B7 00 EC 07 ; VIF, VIFE's meaning event type, data contains 07EChex  
= 2028 meaning Alarm 16

0E ED B9 00 29 22 10 22 09 14 ;Time/date 29:22:10 / 22-09-14 (sec:min:hour /  
day-month-year)

04 A0 00 16 00 00 00 ;Duration 16hex = 22 seconds

1F ;Dif 1F -> More events exist in next telegram

E9 16 ;Checksum and stop byte

System sends out request UD2:

10 7B FE 79 16

Meter sends out data telegram:

68 88 88 68 08 00 72 34 12 00 00 42 04 20 02 02 20 00 00 ;Data header

02 FF F9 B7 00 EC 07 ; VIF, VIFE's meaning event type, data contains 07EChex = 2028 meaning Alarm 16

0E ED B9 00 46 19 10 22 09 14 ;Time/date 46:19:10 / 22-09-14 (sec:min:hour / day-month-year)

04 A0 00 1B 00 00 00 ;Duration 1Bhex = 27 seconds

02 FF F9 B7 00 F2 03 ; VIF, VIFE's meaning event type, data contains 03F2hex = 1010 meaning Date not set

0E ED B9 15 00 00 00 00 00 00 ;Status byte 15hex -> Time/date not available

04 A0 15 00 00 00 00 ;Status byte 15hex -> Duration not available

02 FF F9 B7 00 F3 03 ; VIF, VIFE's meaning event type, data contains 03F3hex = 1010 meaning Time not set

0E ED B9 15 00 00 00 00 00 00 ;Status byte 15hex -> Time/date not available

04 A0 15 00 00 00 00 ;Status byte 15hex -> Duration not available

;No more events exists. However, the meter sends out 5 events in each telegram and fills out the telegram with 2 events where the event, time/date and duration have status byte set to not available (15hex)

02 FF F9 B7 15 00 00

0E ED B9 15 00 00 00 00 00 00

04 A0 15 00 00 00 00

02 FF F9 B7 15 00 00

0E ED B9 15 00 00 00 00 00 00

04 A0 15 00 00 00 00

0F ;Dif 0F -> No more events exist

E9 16 ;Checksum and stop byte

---

### 10.4.5 Readout of Current Harmonics

**Read request**

A read request for current harmonics is performed by sending the following SND\_UD to the meter followed by a REQ\_UD2 (all values are hexadecimal).

| Byte No. | Size | Value | Description   |
|----------|------|-------|---|
| 1        | 1    | 68    | Start character   |
| 2        | 1    | 07    | L-field, calculated from C field to last user data                                |
| 3        | 1    | 07    | L-field, repeated   |
| 4        | 1    | 68    | Start character   |
| 5        | 1    | 53/73 | C-field, SND_UD   |
| 6        | 1    | xx    | A-field, address  |
| 7        | 1    | 51    | CI-field, data send, LSB first  |
| 8        | 1    | 00    | DIF size, no data   |
| 9        | 1    | FF    | VIF next byte is manufacturer specific  |
| 10       | 1    | F9    | VIF extension of manufacturer specific VIFE's, next VIFE specifies actual meaning |
| 11       | 1    | 1B    | VIFE specifies current harmonics  |
| 12       | 1    | xx    | CS checksum, calculated from C field to last data                                 |
| 13       | 2    | 16    | Stop character  |

**Read request for a specific phase**

A read request for a specific phase is performed by sending the following SND\_UD to the meter followed by a REQ\_UD2 (all values are hexadecimal).

| Byte No. | Size | Value | Description   |
|----------|------|-------|---|
| 1        | 1    | 68    | Start character   |
| 2        | 1    | 08    | L-field, calculated from C field to last user data                                |
| 3        | 1    | 08    | L-field, repeated   |
| 4        | 1    | 68    | Start character   |
| 5        | 1    | 53/73 | C-field, SND_UD   |
| 6        | 1    | xx    | A-field, address  |
| 7        | 1    | 51    | CI-field, data send, LSB first  |
| 8        | 1    | 01    | DIF size, 8 bit integer   |
| 9        | 1    | FF    | VIF next byte is manufacturer specific  |
| 10       | 1    | F9    | VIF extension of manufacturer specific VIFE's, next VIFE specifies actual meaning |
| 11       | 1    | 1B    | VIFE specifies current harmonics  |
| 12       | 1    | xx    | Phase number 1-3, 4 for the neutral   |
| 13       | 1    | xx    | CS checksum, calculated from C field to last data                                 |
| 14       | 1    | 16    | Stop character  |

### About the data sent out

The meter will send out harmonic data for one phase in each telegram, which means 4 telegrams in a 3-element meter (for the 3 phase currents and the neutral), 2 telegrams in a 2-element meter (for the phase 1 and 3 currents) and 1 telegram in a single phase meter.

Data sent out will be the total harmonic distortion and the harmonics with numbers 2-16. Note that the total harmonic distortion is calculated from the harmonics measured and is thus not the true total harmonic distortion, which would require all harmonics (up to infinite frequency) to be measured.



**Note** – Data may temporarily be marked "not available" if there are disturbances on the net (for example due to short voltage dips) making the frequency measurement invalid. Also directly after startup all harmonics will be marked "not available" as they haven't been measured yet. As the harmonics are measured sequentially one at a time they will be available one by one.

---

### 10.4.5.1 Examples of Readouts of Current Harmonics Data

#### Comments

In the following are 2 examples of readouts of current harmonics data. The second example, which is in telegram format, is commented. The comments are preceded by semicolon. The data in both telegrams is hexadecimal.

---

#### Example 1

The readout telegram for a phase contains the following data:

| Byte No. | Size | Value   | Description  |
|----------|------|---------|--|
| 1        | 1    | 68      | Start character                                    |
| 2        | 1    | C0      | L-field, calculated from C field to last user data |
| 3        | 1    | C0      | L-field, repeated                                  |
| 4        | 1    | 68      | Start character                                    |
| 5        | 1    | 08      | C-field, RSP_UD                                    |
| 6        | 1    | xx      | A-field, address                                   |
| 7        | 1    | 72      | CI-field, data send, LSB first                     |
| 8-11     | 4    | xxxxxxx | Meter serial number, 8 BCD digits                  |
| 12-13    | 2    | 4204    | Manufacturer: ABB                                  |
| 14       | 1    | xx      | Protocol version                                   |
| 15       | 1    | 02      | Medium, 02=electricity                             |
| 16       | 1    | xx      | Access number                                      |
| 17       | 1    | xx      | Status   |
| 18-19    | 1    | 0000    | Signature (0000=no encryption)                     |
| 20       | 1    | 02      | DIF size, 2 byte integer                           |
| 21       | 1    | FF      | VIF next byte is manufacturer specific             |
| 22       | 1    | ED      | VIFE current harmonics                             |
| 23       | 1    | FF      | VIFE next byte is manufacturer specific            |

| Byte No. | Size | Value | Description  |
|----------|------|-------|--|
| 24       | 1    | 8x    | VIFE phase x   |
| 25       | 1    | FF    | VIFE next byte is manufacturer specific                                    |
| 26       | 1    | F8    | Extension of manufacturer specific VIFE's, next VIFE(s) used for numbering |
| 27       | 1    | 80    | VIFE with number 0 signifies total harmonics                               |
| 28       | 1    | xx    | VIFE containing status   |
| 29-30    | 2    | xxxx  | Total harmonics in percent with 1 decimal                                  |
| 31       | 1    | 02    | DIF size, 2 byte integer   |
| 32       | 1    | FF    | VIF next byte is manufacturer specific                                     |
| 33       | 1    | ED    | VIFE current harmonics   |
| 34       | 1    | FF    | VIFE next byte is manufacturer specific                                    |
| 35       | 1    | 8x    | VIFE phase x   |
| 36       | 1    | FF    | VIFE next byte is manufacturer specific                                    |
| 36       | 1    | F8    | Extension of manufacturer specific VIFE's, next VIFE(s) used for numbering |
| 38       | 1    | 82    | VIFE signifies harmonic number 2   |
| 39       | 1    | xx    | VIFE containing status   |
| 40-41    | 2    | xxxx  | 2:nd harmonic in percent with 1 decimal                                    |
| 42       | 1    | 02    | DIF size, 2 byte integer   |
| 43       | 1    | FF    | VIF next byte is manufacturer specific                                     |
| 44       | 1    | ED    | VIFE current harmonics   |
| 45       | 1    | FF    | VIF next byte is manufacturer specific                                     |
| 46       | 1    | 8x    | VIFE phase x   |
| 47       | 1    | FF    | VIF next byte is manufacturer specific                                     |
| 48       | 1    | F8    | Extension of manufacturer specific VIFE's, next VIFE(s) used for numbering |
| 49       | 1    | 83    | VIFE signifies harmonic number 3   |
| 50       | 1    | xx    | VIFE containing status   |
| 51-52    | 2    | xxxx  | 3:rd harmonic in percent with 1 decimal                                    |
| 53       | 1    | 02    | DIF size, 2 byte integer   |
| 54       | 1    | FF    | VIF next byte is manufacturer specific                                     |
| 55       | 1    | ED    | VIFE current harmonics   |
| 56       | 1    | FF    | VIF next byte is manufacturer specific                                     |
| 57       | 1    | 8x    | VIFE phase x   |
| 58       | 1    | FF    | VIF next byte is manufacturer specific                                     |
| 59       | 1    | F8    | Extension of manufacturer specific VIFE's, next VIFE(s) used for numbering |
| 60       | 1    | 84    | VIFE signifies harmonic number 4   |
| 61       | 1    | xx    | VIFE containing status   |
| 62-63    | 2    | xxxx  | 4:th harmonic in percent with 1 decimal                                    |
| 64       | 1    | 02    | DIF size, 2 byte integer   |
| 65       | 1    | FF    | VIF next byte is manufacturer specific                                     |

| Byte No. | Size | Value | Description  |
|----------|------|-------|--|
| 66       | 1    | ED    | VIFE current harmonics   |
| 67       | 1    | FF    | VIF next byte is manufacturer specific                                     |
| 68       | 1    | 8x    | VIFE phase x   |
| 69       | 1    | FF    | VIF next byte is manufacturer specific                                     |
| 70       | 1    | F8    | Extension of manufacturer specific VIFE's, next VIFE(s) used for numbering |
| 71       | 1    | 85    | VIFE signifies harmonic number 5   |
| 72       | 1    | xx    | VIFE containing status   |
| 73-74    | 2    | xxxx  | 5:th harmonic in percent with 1 decimal                                    |
| 75       | 1    | 02    | DIF size, 2 byte integer   |
| 76       | 1    | FF    | VIF next byte is manufacturer specific                                     |
| 77       | 1    | ED    | VIFE current harmonics   |
| 78       | 1    | FF    | VIF next byte is manufacturer specific                                     |
| 79       | 1    | 8x    | VIFE phase x   |
| 80       | 1    | FF    | VIF next byte is manufacturer specific                                     |
| 81       | 1    | F8    | Extension of manufacturer specific VIFE's, next VIFE(s) used for numbering |
| 82       | 1    | 86    | VIFE signifies harmonic number 6   |
| 83       | 1    | xx    | VIFE containing status   |
| 84-85    | 2    | xxxx  | 6:th harmonic in percent with 1 decimal                                    |
| 86       | 1    | 02    | DIF size, 2 byte integer   |
| 87       | 1    | FF    | VIF next byte is manufacturer specific                                     |
| 88       | 1    | ED    | VIFE current harmonics   |
| 89       | 1    | FF    | VIF next byte is manufacturer specific                                     |
| 90       | 1    | 8x    | VIFE phase x   |
| 91       | 1    | FF    | VIF next byte is manufacturer specific                                     |
| 92       | 1    | F8    | Extension of manufacturer specific VIFE's, next VIFE(s) used for numbering |
| 93       | 1    | 87    | VIFE signifies harmonic number 7   |
| 94       | 1    | xx    | VIFE containing status   |
| 95-96    | 2    | xxxx  | 7:th harmonic in percent with 1 decimal                                    |
| 97       | 1    | 02    | DIF size, 2 byte integer   |
| 98       | 1    | FF    | VIF next byte is manufacturer specific                                     |
| 99       | 1    | ED    | VIFE current harmonics   |
| 100      | 1    | FF    | VIF next byte is manufacturer specific                                     |
| 101      | 1    | 8x    | VIFE phase x   |
| 102      | 1    | FF    | VIF next byte is manufacturer specific                                     |
| 103      | 1    | F8    | Extension of manufacturer specific VIFE's, next VIFE(s) used for numbering |
| 104      | 1    | 88    | VIFE signifies harmonic number 8   |
| 105      | 1    | xx    | VIFE containing status   |
| 106-107  | 2    | xxxx  | 8:th harmonic in percent with 1 decimal                                    |



| Byte No. | Size | Value | Description  |
|----------|------|-------|--|
| 108      | 1    | 02    | DIF size, 2 byte integer   |
| 109      | 1    | FF    | VIF next byte is manufacturer specific                                     |
| 110      | 1    | ED    | VIFE current harmonics   |
| 111      | 1    | FF    | VIF next byte is manufacturer specific                                     |
| 112      | 1    | 8x    | VIFE phase x   |
| 113      | 1    | FF    | VIF next byte is manufacturer specific                                     |
| 114      | 1    | F8    | Extension of manufacturer specific VIFE's, next VIFE(s) used for numbering |
| 115      | 1    | 89    | VIFE signifies harmonic number 9   |
| 116      | 1    | xx    | VIFE containing status   |
| 117-118  | 2    | xxxx  | 9:th harmonic in percent with 1 decimal                                    |
| 119      | 1    | 02    | DIF size, 2 byte integer   |
| 120      | 1    | FF    | VIF next byte is manufacturer specific                                     |
| 121      | 1    | ED    | VIFE current harmonics   |
| 122      | 1    | FF    | VIF next byte is manufacturer specific                                     |
| 123      | 1    | 8x    | VIFE phase x   |
| 124      | 1    | FF    | VIF next byte is manufacturer specific                                     |
| 125      | 1    | F8    | Extension of manufacturer specific VIFE's, next VIFE(s) used for numbering |
| 126      | 1    | 8A    | VIFE signifies harmonic number 10  |
| 127      | 1    | xx    | VIFE containing status   |
| 128-129  | 2    | xxxx  | 10:th harmonic in percent with 1 decimal                                   |
| 130      | 1    | 02    | DIF size, 2 byte integer   |
| 131      | 1    | FF    | VIF next byte is manufacturer specific                                     |
| 132      | 1    | ED    | VIFE current harmonics   |
| 133      | 1    | FF    | VIF next byte is manufacturer specific                                     |
| 134      | 1    | 8x    | VIFE phase x   |
| 135      | 1    | FF    | VIF next byte is manufacturer specific                                     |
| 136      | 1    | F8    | Extension of manufacturer specific VIFE's, next VIFE(s) used for numbering |
| 137      | 1    | 8B    | VIFE signifies harmonic number 11  |
| 138      | 1    | xx    | VIFE containing status   |
| 139-140  | 2    | xxxx  | 11:th harmonic in percent with 1 decimal                                   |
| 141      | 1    | 02    | DIF size, 2 byte integer   |
| 142      | 1    | FF    | VIF next byte is manufacturer specific                                     |
| 143      | 1    | ED    | VIFE current harmonics   |
| 144      | 1    | FF    | VIF next byte is manufacturer specific                                     |
| 145      | 1    | 8x    | VIFE phase x   |
| 146      | 1    | FF    | VIF next byte is manufacturer specific                                     |
| 147      | 1    | F8    | Extension of manufacturer specific VIFE's, next VIFE(s) used for numbering |
| 148      | 1    | 8C    | VIFE signifies harmonic number 12  |

| Byte No. | Size | Value | Description  |
|----------|------|-------|--|
| 149      | 1    | xx    | VIFE containing status   |
| 150-151  | 2    | xxxx  | 12:th harmonic in percent with 1 decimal                                   |
| 152      | 1    | 02    | DIF size, 2 byte integer   |
| 153      | 1    | FF    | VIF next byte is manufacturer specific                                     |
| 154      | 1    | ED    | VIFE current harmonics   |
| 155      | 1    | FF    | VIF next byte is manufacturer specific                                     |
| 156      | 1    | 8x    | VIFE phase x   |
| 157      | 1    | FF    | VIF next byte is manufacturer specific                                     |
| 158      | 1    | F8    | Extension of manufacturer specific VIFE's, next VIFE(s) used for numbering |
| 159      | 1    | 8D    | VIFE signifies harmonic number 13  |
| 160      | 1    | xx    | VIFE containing status   |
| 161-162  | 2    | xxxx  | 13:th harmonic in percent with 1 decimal                                   |
| 163      | 1    | 02    | DIF size, 2 byte integer   |
| 164      | 1    | FF    | VIF next byte is manufacturer specific                                     |
| 165      | 1    | ED    | VIFE current harmonics   |
| 166      | 1    | FF    | VIF next byte is manufacturer specific                                     |
| 167      | 1    | 8x    | VIFE phase x   |
| 168      | 1    | FF    | VIF next byte is manufacturer specific                                     |
| 169      | 1    | F8    | Extension of manufacturer specific VIFE's, next VIFE(s) used for numbering |
| 170      | 1    | 8E    | VIFE signifies harmonic number 14  |
| 171      | 1    | xx    | VIFE containing status   |
| 172-173  | 2    | xxxx  | 14:th harmonic in percent with 1 decimal                                   |
| 174      | 1    | 02    | DIF size, 2 byte integer   |
| 175      | 1    | FF    | VIF next byte is manufacturer specific                                     |
| 176      | 1    | ED    | VIFE current harmonics   |
| 177      | 1    | FF    | VIF next byte is manufacturer specific                                     |
| 178      | 1    | 8x    | VIFE phase x   |
| 179      | 1    | FF    | VIF next byte is manufacturer specific                                     |
| 180      | 1    | F8    | Extension of manufacturer specific VIFE's, next VIFE(s) used for numbering |
| 181      | 1    | 8F    | VIFE signifies harmonic number 15  |
| 182      | 1    | xx    | VIFE containing status   |
| 183-184  | 2    | xxxx  | 15:th harmonic in percent with 1 decimal                                   |
| 185      | 1    | 02    | DIF size, 2 byte integer   |
| 186      | 1    | FF    | VIF next byte is manufacturer specific                                     |
| 187      | 1    | ED    | VIFE current harmonics   |
| 188      | 1    | FF    | VIF next byte is manufacturer specific                                     |
| 189      | 1    | 8x    | VIFE phase x   |
| 190      | 1    | FF    | VIF next byte is manufacturer specific                                     |

| Byte No. | Size | Value | Description  |
|----------|------|-------|--|
| 191      | 1    | F8    | Extension of manufacturer specific VIFE's, next VIFE(s) used for numbering |
| 192      | 1    | 90    | VIFE signifies harmonic number 16  |
| 193      | 1    | xx    | VIFE containing status   |
| 194-195  | 2    | xxxx  | 16:th harmonic in percent with 1 decimal                                   |
| 196      | 1    | xx    | End DIF, 1F if more data telegrams will follow, 0F last telegram           |
| 197      | 1    | xx    | CS checksum, calculated from C field to last data                          |
| 198      | 1    | 16    | Stop character   |

### Example 2, readout of current harmonic data starting from phase 2

System sends current harmonic data read request command

68 08 08 68 73 FE 51 01 FF F9 1B 02 D8 16

Meter sends out acknowledge:

E5

System sends out request UD2:

10 7B FE 79 16

Meter sends out data telegram:

68 C0 C0 68 08 02 72 34 12 00 00 42 04 20 02 1C 00 00 00 ;Data header

02 FF ED FF 82 FF F8 80 00 2A 01 ;Total current harmonic distortion for phase 2 = 29.8 %

02 FF ED FF 82 FF F8 82 00 18 00 ;2:nd current harmonic distortion for phase 2 = 2.4 %

02 FF ED FF 82 FF F8 83 00 4D 00 ;3:rd current harmonic distortion for phase 2 = 7.7 %

02 FF ED FF 82 FF F8 84 00 48 00 ;4:th current harmonic distortion for phase 2 = 7.2 %

02 FF ED FF 82 FF F8 85 00 2F 00 ;5:th current harmonic distortion for phase 2 = 4.7 %

02 FF ED FF 82 FF F8 86 00 18 00 ;6:th current harmonic distortion for phase 2 = 2.4 %

02 FF ED FF 82 FF F8 87 00 79 00 ;7:th current harmonic distortion for phase 2 = 12.1 %

02 FF ED FF 82 FF F8 88 00 57 00 ;8:th current harmonic distortion for phase 2 = 8.7 %

02 FF ED FF 82 FF F8 89 00 58 00 ;9:th current harmonic distortion for phase 2 = 8.8 %

02 FF ED FF 82 FF F8 8A 00 1C 00 ;10:th current harmonic distortion for phase 2 = 2.8 %

02 FF ED FF 82 FF F8 8B 00 1A 00 ;11:th current harmonic distortion for phase 2 = 2.6 %

02 FF ED FF 82 FF F8 8C 00 86 00 ;12:th current harmonic distortion for phase 2 = 13.4 %

02 FF ED FF 82 FF F8 8D 00 1C 00 ;13:th current harmonic distortion for phase 2 = 2.8 %

02 FF ED FF 82 FF F8 8E 00 36 00 ;14:th current harmonic distortion for phase 2 = 5.4 %

02 FF ED FF 82 FF F8 8F 00 49 00 ;15:th current harmonic distorsion for phase  
2 = 7.3 %

02 FF ED FF 82 FF F8 90 00 7F 00 ;16:th current harmonic distorsion for phase  
2 = 12.7%

1F ; Dif 1F -> More harmonic data exist

69 16 ;Checksum an stopbyte

System sends out request UD2:

10 7B FE 79 16

Meter sends out data current harmonic data for phase 3:

68 C0 C0 68 08 02 72 34 12 00 00 42 04 20 02 1D 00 00 00

02 FF ED FF 83 FF F8 80 00 49 01

02 FF ED FF 83 FF F8 82 00 1B 00

02 FF ED FF 83 FF F8 83 00 8F 00

02 FF ED FF 83 FF F8 84 00 26 00

02 FF ED FF 83 FF F8 85 00 2E 00

02 FF ED FF 83 FF F8 86 00 18 00

02 FF ED FF 83 FF F8 87 00 8A 00

02 FF ED FF 83 FF F8 88 00 53 00

02 FF ED FF 83 FF F8 89 00 56 00

02 FF ED FF 83 FF F8 8A 00 24 00

02 FF ED FF 83 FF F8 8B 00 21 00

02 FF ED FF 83 FF F8 8C 00 89 00

02 FF ED FF 83 FF F8 8D 00 22 00

02 FF ED FF 83 FF F8 8E 00 31 00

02 FF ED FF 83 FF F8 8F 00 4D 00

02 FF ED FF 83 FF F8 90 00 8A 00

1F

E8 16

System sends out request UD2:

10 7B FE 79 16

Meter sends out data current harmonic data for the neutral current:

68 C0 C0 68 08 02 72 34 12 00 00 42 04 20 02 1E 00 00 00

02 FF ED FF 84 FF F8 80 00 31 01

02 FF ED FF 84 FF F8 82 00 18 00

02 FF ED FF 84 FF F8 83 00 90 00

02 FF ED FF 84 FF F8 84 00 12 00

02 FF ED FF 84 FF F8 85 00 63 00

02 FF ED FF 84 FF F8 86 00 31 00

02 FF ED FF 84 FF F8 87 00 0E 00  
 02 FF ED FF 84 FF F8 88 00 56 00  
 02 FF ED FF 84 FF F8 89 00 57 00  
 02 FF ED FF 84 FF F8 8A 00 1B 00  
 02 FF ED FF 84 FF F8 8B 00 18 00  
 02 FF ED FF 84 FF F8 8C 00 85 00  
 02 FF ED FF 84 FF F8 8D 00 1C 00  
 02 FF ED FF 84 FF F8 8E 00 35 00  
 02 FF ED FF 84 FF F8 8F 00 49 00  
 02 FF ED FF 84 FF F8 90 00 7F 00  
 0F ;Dif 0F, no more telegrams  
 6A 16

---

### 10.4.6 Readout of Voltage Harmonics

---

**Read request**

A read request for voltage harmonics is performed by sending the following SND\_UD to the meter followed by a REQ\_UD2 (all values are hexadecimal).

| Byte No. | Size | Value | Description   |
|----------|------|-------|---|
| 1        | 1    | 68    | Start character   |
| 2        | 1    | 07    | L-field, calculated from C field to last user data                                |
| 3        | 1    | 07    | L-field, repeated   |
| 4        | 1    | 68    | Start character   |
| 5        | 1    | 53/73 | C-field, SND_UD   |
| 6        | 1    | xx    | A-field, address  |
| 7        | 1    | 51    | CI-field, data send, LSB first  |
| 8        | 1    | 00    | DIF size, no data   |
| 9        | 1    | FF    | VIF next byte is manufacturer specific  |
| 10       | 1    | F9    | VIF extension of manufacturer specific VIFE's, next VIFE specifies actual meaning |
| 11       | 1    | 2D    | VIFE specifies voltage harmonics  |
| 12       | 1    | xx    | CS checksum, calculated from C field to last data                                 |
| 13       | 2    | 16    | Stop character  |

---

**Read request for a specific phase**

A read request for a specific phase is performed by sending the following SND\_UD to the meter followed by a REQ\_UD2 (all values are hexadecimal).

| Byte No. | Size | Value | Description     |
|----------|------|-------|-----------------|
| 1        | 1    | 68    | Start character |

| Byte No. | Size | Value | Description  |
|----------|------|-------|--|
| 2        | 1    | 08    | L-field, calculated from C field to last user data   |
| 3        | 1    | 08    | L-field, repeated  |
| 4        | 1    | 68    | Start character  |
| 5        | 1    | 53/73 | C-field, SND_UD  |
| 6        | 1    | xx    | A-field, address   |
| 7        | 1    | 51    | CI-field, data send, LSB first   |
| 8        | 1    | 01    | DIF size, 8 bit integer  |
| 9        | 1    | FF    | VIF next byte is manufacturer specific   |
| 10       | 1    | F9    | VIF extension of manufacturer specific VIFE's, next VIFE specifies actual meaning  |
| 11       | 1    | 2D    | VIFE specifies voltage harmonics   |
| 12       | 1    | xx    | Phase number 1-3, 5-7 where 1-3 is used for the three phase to neutral voltages and 5-7 is for the phase to phase voltages L1-L2, L3-L2, L1-L3 |
| 13       | 1    | xx    | CS checksum, calculated from C field to last data  |
| 14       | 1    | 16    | Stop character   |

**About the data sent out**

The meter will send out harmonic data for one phase in each telegram, which means 6 telegrams in a 3-element meter, 3 telegrams in a 2-element meter and 1 telegram in a single phase meter.

Data sent out will be the total harmonic distortion and the harmonics with numbers 2-16. Note that the total harmonic distortion is calculated from the harmonics measured and is thus not the true total harmonic distortion, which would require all harmonics (up to infinite frequency) to be measured.

**10.4.6.1 Examples of readout of voltage harmonics data**

**Example 1**

The readout telegram for voltage phase harmonic contains the following data:

| Byte No. | Size | Value   | Description  |
|----------|------|---------|--|
| 1        | 1    | 68      | Start character                                    |
| 2        | 1    | C0      | L-field, calculated from C field to last user data |
| 3        | 1    | C0      | L-field, repeated                                  |
| 4        | 1    | 68      | Start character                                    |
| 5        | 1    | 08      | C-field, RSP_UD                                    |
| 6        | 1    | xx      | A-field, address                                   |
| 7        | 1    | 72      | CI-field, data send, LSB first                     |
| 8-11     | 4    | xxxxxxx | identification number, 8 BCD digits                |
| 12-13    | 2    | 4204    | Manufacturer: ABB                                  |
| 14       | 1    | xx      | Protocol version                                   |
| 15       | 1    | 02      | Medium, 02=electricity                             |
| 16       | 1    | xx      | Access number                                      |

| Byte No. | Size | Value | Description  |
|----------|------|-------|--|
| 17       | 1    | xx    | Status   |
| 18-19    | 1    | 0000  | Signature (0000=no encryption)   |
| 20       | 1    | 02    | DIF size, 2 byte integer   |
| 21       | 1    | FF    | VIF next byte is manufacturer specific                                     |
| 22       | 1    | EE    | VIFE voltage harmonics   |
| 23       | 1    | FF    | VIF next byte is manufacturer specific                                     |
| 24       | 1    | 8x    | VIFE phase x   |
| 25       | 1    | FF    | VIF next byte is manufacturer specific                                     |
| 26       | 1    | F8    | Extension of manufacturer specific VIFE's, next VIFE(s) used for numbering |
| 27       | 1    | 80    | VIFE with number 0 signifies total harmonics                               |
| 28       | 1    | xx    | VIFE containing status   |
| 29-30    | 2    | xxxx  | Total harmonics in percent with 1 decimal                                  |
| 31       | 1    | 02    | DIF size, 2 byte integer   |
| 32       | 1    | FF    | VIF next byte is manufacturer specific                                     |
| 33       | 1    | EE    | VIFE voltage harmonics   |
| 34       | 1    | FF    | VIF next byte is manufacturer specific                                     |
| 35       | 1    | 8x    | VIFE phase x   |
| 36       | 1    | FF    | VIF next byte is manufacturer specific                                     |
| 37       | 1    | F8    | Extension of manufacturer specific VIFE's, next VIFE(s) used for numbering |
| 38       | 1    | 82    | VIFE signifies harmonic number 2   |
| 39       | 1    | xx    | VIFE containing status   |
| 40-41    | 2    | xxxx  | 2:nd harmonic in percent with 1 decimal                                    |
| 42       | 1    | 02    | DIF size, 2 byte integer   |
| 43       | 1    | FF    | VIF next byte is manufacturer specific                                     |
| 44       | 1    | EE    | VIFE voltage harmonics   |
| 45       | 1    | FF    | VIF next byte is manufacturer specific                                     |
| 46       | 1    | 8x    | VIFE phase x   |
| 47       | 1    | FF    | VIF next byte is manufacturer specific                                     |
| 48       | 1    | F8    | Extension of manufacturer specific VIFE's, next VIFE(s) used for numbering |
| 49       | 1    | 83    | VIFE signifies harmonic number 3   |
| 50       | 1    | xx    | VIFE containing status   |
| 51-52    | 2    | xxxx  | 3:rd harmonic in percent with 1 decimal                                    |
| 53       | 1    | 02    | DIF size, 2 byte integer   |
| 54       | 1    | FF    | VIF next byte is manufacturer specific                                     |
| 55       | 1    | EE    | VIFE voltage harmonics   |
| 56       | 1    | FF    | VIF next byte is manufacturer specific                                     |
| 57       | 1    | 8x    | VIFE phase x   |
| 58       | 1    | FF    | VIF next byte is manufacturer specific                                     |



| Byte No. | Size | Value | Description  |
|----------|------|-------|--|
| 59       | 1    | F8    | Extension of manufacturer specific VIFE's, next VIFE(s) used for numbering |
| 60       | 1    | 84    | VIFE signifies harmonic number 4   |
| 61       | 1    | xx    | VIFE containing status   |
| 62-63    | 2    | xxxx  | 4:th harmonic in percent with 1 decimal                                    |
| 64       | 1    | 02    | DIF size, 2 byte integer   |
| 65       | 1    | FF    | VIF next byte is manufacturer specific                                     |
| 66       | 1    | EE    | VIFE voltage harmonics   |
| 67       | 1    | FF    | VIF next byte is manufacturer specific                                     |
| 68       | 1    | 8x    | VIFE phase x   |
| 69       | 1    | FF    | VIF next byte is manufacturer specific                                     |
| 70       | 1    | F8    | Extension of manufacturer specific VIFE's, next VIFE(s) used for numbering |
| 71       | 1    | 85    | VIFE signifies harmonic number 5   |
| 72       | 1    | xx    | VIFE containing status   |
| 73-74    | 2    | xxxx  | 5:th harmonic in percent with 1 decimal                                    |
| 75       | 1    | 02    | DIF size, 2 byte integer   |
| 76       | 1    | FF    | VIF next byte is manufacturer specific                                     |
| 77       | 1    | EE    | VIFE voltage harmonics   |
| 78       | 1    | FF    | VIF next byte is manufacturer specific                                     |
| 79       | 1    | 8x    | VIFE phase x   |
| 80       | 1    | FF    | VIF next byte is manufacturer specific                                     |
| 81       | 1    | F8    | Extension of manufacturer specific VIFE's, next VIFE(s) used for numbering |
| 82       | 1    | 86    | VIFE signifies harmonic number 6   |
| 83       | 1    | xx    | VIFE containing status   |
| 84-85    | 2    | xxxx  | 6:th harmonic in percent with 1 decimal                                    |
| 86       | 1    | 02    | DIF size, 2 byte integer   |
| 87       | 1    | FF    | VIF next byte is manufacturer specific                                     |
| 88       | 1    | EE    | VIFE voltage harmonics   |
| 89       | 1    | FF    | VIF next byte is manufacturer specific                                     |
| 90       | 1    | 8x    | VIFE phase x   |
| 91       | 1    | FF    | VIF next byte is manufacturer specific                                     |
| 92       | 1    | F8    | Extension of manufacturer specific VIFE's, next VIFE(s) used for numbering |
| 93       | 1    | 87    | VIFE signifies harmonic number 7   |
| 94       | 1    | xx    | VIFE containing status   |
| 95-96    | 2    | xxxx  | 7:th harmonic in percent with 1 decimal                                    |
| 97       | 1    | 02    | DIF size, 2 byte integer   |
| 98       | 1    | FF    | VIF next byte is manufacturer specific                                     |
| 99       | 1    | EE    | VIFE voltage harmonics   |
| 100      | 1    | FF    | VIF next byte is manufacturer specific                                     |

| Byte No. | Size | Value | Description  |
|----------|------|-------|--|
| 101      | 1    | 8x    | VIFE phase x   |
| 102      | 1    | FF    | VIF next byte is manufacturer specific                                     |
| 103      | 1    | F8    | Extension of manufacturer specific VIFE's, next VIFE(s) used for numbering |
| 104      | 1    | 88    | VIFE signifies harmonic number 8   |
| 105      | 1    | xx    | VIFE containing status   |
| 106-107  | 2    | xxxx  | 8:th harmonic in percent with 1 decimal                                    |
| 108      | 1    | 02    | DIF size, 2 byte integer   |
| 109      | 1    | FF    | VIF next byte is manufacturer specific                                     |
| 110      | 1    | EE    | VIFE voltage harmonics   |
| 111      | 1    | ff    | VIF next byte is manufacturer specific                                     |
| 112      | 1    | 8x    | VIFE phase x   |
| 113      | 1    | FF    | VIF next byte is manufacturer specific                                     |
| 114      | 1    | F8    | Extension of manufacturer specific VIFE's, next VIFE(s) used for numbering |
| 115      | 1    | 89    | VIFE signifies harmonic number 9   |
| 116      | 1    | xx    | VIFE containing status   |
| 117-118  | 2    | xxxx  | 9:th harmonic in percent with 1 decimal                                    |
| 119      | 1    | 02    | DIF size, 2 byte integer   |
| 120      | 1    | FF    | VIF next byte is manufacturer specific                                     |
| 121      | 1    | EE    | VIFE voltage harmonics   |
| 122      | 1    | ff    | VIF next byte is manufacturer specific                                     |
| 123      | 1    | 8x    | VIFE phase x   |
| 124      | 1    | FF    | VIF next byte is manufacturer specific                                     |
| 125      | 1    | F8    | Extension of manufacturer specific VIFE's, next VIFE(s) used for numbering |
| 126      | 1    | 8A    | VIFE signifies harmonic number 10  |
| 127      | 1    | xx    | VIFE containing status   |
| 128-129  | 2    | xxxx  | 10:th harmonic in percent with 1 decimal                                   |
| 130      | 1    | 02    | DIF size, 2 byte integer   |
| 131      | 1    | FF    | VIF next byte is manufacturer specific                                     |
| 132      | 1    | EE    | VIFE voltage harmonics   |
| 133      | 1    | ff    | VIF next byte is manufacturer specific                                     |
| 134      | 1    | 8x    | VIFE phase x   |
| 135      | 1    | FF    | VIF next byte is manufacturer specific                                     |
| 136      | 1    | F8    | Extension of manufacturer specific VIFE's, next VIFE(s) used for numbering |
| 137      | 1    | 8B    | VIFE signifies harmonic number 11  |
| 138      | 1    | xx    | VIFE containing status   |
| 139-140  | 2    | xxxx  | 11:th harmonic in percent with 1 decimal                                   |
| 141      | 1    | 02    | DIF size, 2 byte integer   |
| 142      | 1    | FF    | VIF next byte is manufacturer specific                                     |

| Byte No. | Size | Value | Description  |
|----------|------|-------|--|
| 143      | 1    | EE    | VIFE voltage harmonics   |
| 144      | 1    | ff    | VIF next byte is manufacturer specific                                     |
| 145      | 1    | 8x    | VIFE phase x   |
| 146      | 1    | FF    | VIF next byte is manufacturer specific                                     |
| 147      | 1    | F8    | Extension of manufacturer specific VIFE's, next VIFE(s) used for numbering |
| 148      | 1    | 8C    | VIFE signifies harmonic number 12  |
| 149      | 1    | xx    | VIFE containing status   |
| 150-151  | 2    | xxxx  | 12:th harmonic in percent with 1 decimal                                   |
| 152      | 1    | 02    | DIF size, 2 byte integer   |
| 153      | 1    | FF    | VIF next byte is manufacturer specific                                     |
| 154      | 1    | EE    | VIFE voltage harmonics   |
| 155      | 1    | ff    | VIF next byte is manufacturer specific                                     |
| 156      | 1    | 8x    | VIFE phase x   |
| 157      | 1    | FF    | VIF next byte is manufacturer specific                                     |
| 158      | 1    | F8    | Extension of manufacturer specific VIFE's, next VIFE(s) used for numbering |
| 159      | 1    | 8D    | VIFE signifies harmonic number 13  |
| 160      | 1    | xx    | VIFE containing status   |
| 161-162  | 2    | xxxx  | 13:th harmonic in percent with 1 decimal                                   |
| 163      | 1    | 02    | DIF size, 2 byte integer   |
| 164      | 1    | FF    | VIF next byte is manufacturer specific                                     |
| 165      | 1    | EE    | VIFE voltage harmonics   |
| 166      | 1    | ff    | VIF next byte is manufacturer specific                                     |
| 167      | 1    | 8x    | VIFE phase x   |
| 168      | 1    | FF    | VIF next byte is manufacturer specific                                     |
| 169      | 1    | F8    | Extension of manufacturer specific VIFE's, next VIFE(s) used for numbering |
| 170      | 1    | 8E    | VIFE signifies harmonic number 14  |
| 171      | 1    | xx    | VIFE containing status   |
| 172-173  | 2    | xxxx  | 14:th harmonic in percent with 1 decimal                                   |
| 174      | 1    | 02    | DIF size, 2 byte integer   |
| 175      | 1    | FF    | VIF next byte is manufacturer specific                                     |
| 176      | 1    | EE    | VIFE voltage harmonics   |
| 177      | 1    | ff    | VIF next byte is manufacturer specific                                     |
| 178      | 1    | 8x    | VIFE phase x   |
| 179      | 1    | FF    | VIF next byte is manufacturer specific                                     |
| 180      | 1    | F8    | Extension of manufacturer specific VIFE's, next VIFE(s) used for numbering |
| 182      | 1    | 8F    | VIFE signifies harmonic number 15  |
| 182      | 1    | xx    | VIFE containing status   |
| 183-184  | 2    | xxxx  | 15:th harmonic in percent with 1 decimal                                   |

| Byte No. | Size | Value | Description  |
|----------|------|-------|--|
| 185      | 1    | 02    | DIF size, 2 byte integer   |
| 186      | 1    | FF    | VIF next byte is manufacturer specific                                     |
| 187      | 1    | EE    | VIFE voltage harmonics   |
| 188      | 1    | FF    | VIF next byte is manufacturer specific                                     |
| 189      | 1    | 8x    | VIFE phase x   |
| 190      | 1    | FF    | VIF next byte is manufacturer specific                                     |
| 191      | 1    | F8    | Extension of manufacturer specific VIFE's, next VIFE(s) used for numbering |
| 192      | 1    | 90    | VIFE signifies harmonic number 16  |
| 193      | 1    | xx    | VIFE containing status   |
| 194-195  | 2    | xxxx  | 16:th harmonic in percent with 1 decimal                                   |
| 196      | 1    | xx    | DIF, 1F if more records will follow in next telegram, 0F if last telegram  |
| 197      | 1    | xx    | CS checksum, calculated from C field to last data                          |
| 198      | 1    | 16    | Stop character   |

**Example 2**

Sending initialize command

10 40 FE 3E 16

Reading acknowledge

E5

System sends voltage harmonic data read request command

68 08 08 68 73 FE 51 00 FF F9 2D 01 E8 16

Meter sends out acknowledge

E5

System sends out request UD2

10 7B FE 79 16

Meter sends out data telegram

6E C0 C0 68 08 00 72 00 00 00 00 42 04 20 02 03 2A 00 00 ;Data header

02 FF EE FF 81 FF F8 80 00 11 01 ;Total voltage harmonic distortion for phase 1 = 27.3%

02 FF EE FF 81 FF F8 82 00 1E 00 ;2nd voltage harmonic distortion for phase 1 = 3.0%

02 FF EE FF 81 FF F8 83 00 03 01 ;3rd voltage harmonic distortion for phase 1 = 25.9%

02 FF EE FF 81 FF F8 84 00 0B 00 ;4th voltage harmonic distortion for phase 1 = 1.1%

02 FF EE FF 81 FF F8 85 00 4D 00 ;5th voltage harmonic distortion for phase 1 = 7.7%

02 FF EE FF 81 FF F8 86 00 03 00 ;6th voltage harmonic distortion for phase 1 = 0.3%

02 FF EE FF 81 FF F8 87 00 08 00 ;7th voltage harmonic distortion for phase 1 = 0.8%

02 FF EE FF 81 FF F8 88 00 01 00 ;8th voltage harmonic distortion for phase 1 = 0.1%

02 FF EE FF 81 FF F8 89 00 12 00 ;9th voltage harmonic distortion for phase 1 = 1.8%

02 FF EE FF 81 FF F8 8A 00 02 00 ;10th voltage harmonic distortion for phase 1 = 0.2%

02 FF EE FF 81 FF F8 8B 00 0E 00 ;11th voltage harmonic distortion for phase 1 = 1.5%

02 FF EE FF 81 FF F8 8C 00 01 00 ;12th voltage harmonic distortion for phase 1 = 0.1%

02 FF EE FF 81 FF F8 8D 00 05 00 ;13th voltage harmonic distortion for phase 1 = 0.5%

02 FF EE FF 81 FF F8 8E 00 00 00 ;14th voltage harmonic distortion for phase 1 = 0.0%

02 FF EE FF 81 FF F8 8F 00 07 00 ;15th voltage harmonic distortion for phase 1 = 0.7%

02 FF EE FF 81 FF F8 90 00 01 00 ;16th voltage harmonic distortion for phase 1 = 0.1%

0F -No more harmonics data exist

D3 16

---

## 10.5 Sending Data to the Meter

### General

This section describes the telegrams that can be sent to an EQ meter. Some of the telegrams contain data, others do not. Data sent in the telegram is sometimes stored in the meter, sometimes used by the meter to perform a certain action. Telegrams that contains no data usually initiates a certain action in the meter.

### Write access level protection

Some of the commands can be protected by a password. There are 3 different levels of write access level protection:

- Open
- Open by password
- Closed

The write access level can be set either via the buttons directly on the meter or via communication using the *set write access level* command.

If the access level is set to *Open*, the meter will always accept the command as long as the the meter is properly addressed and the syntax and checksum are correct.

If the access level is set to *Open by password* the specific command sent to the meter must be preceded by a *send password* command in order for the meter to accept the command.

If the access level is set to *Closed* the meter will not accept any command, but will just return an acknowledge character (E5 hex). To change this access level protection, the access level has to be set to *Open* via the buttons directly on the meter.



**Note** – Commands that are not affected by the write access level protection only require a correct message with correct address, syntax and checksum to be accepted.

### 10.5.1 Set tariff

For meters with tariff control the active tariff is set by sending the following command (all values are hexadecimal). The command is not affected by the write protection level set.

| Byte No. | Size | Value | Description  |
|----------|------|-------|--|
| 1        | 1    | 68    | Start character                                    |
| 2        | 1    | 07    | L-field, calculated from C field to last user data |
| 3        | 1    | 07    | L-field, repeated                                  |
| 4        | 1    | 68    | Start character                                    |
| 5        | 1    | 53/73 | C-field, SND_UD                                    |
| 6        | 1    | xx    | A-field, address                                   |
| 7        | 1    | 51    | CI-field, data send, LSB first                     |
| 8        | 1    | 01    | DIF size, 8 bit integer                            |
| 9        | 1    | FF    | VIF next byte is manufacturer specific             |

| Byte No. | Size | Value | Description                                       |
|----------|------|-------|---|
| 10       | 1    | 13    | VIFE tariff                                       |
| 11       | 1    | xx    | New tariff  |
| 12       | 1    | xx    | CS checksum, calculated from C field to last data |
| 13       | 1    | 16    | Stop character                                    |

### 10.5.2 Set primary address

The primary address is set by sending the following command (all values are hexadecimal). The command is not affected by the write protection level set.

| Byte No. | Size | Value | Description  |
|----------|------|-------|--|
| 1        | 1    | 68    | Start character                                    |
| 2        | 1    | 06    | L-field, calculated from C field to last user data |
| 3        | 1    | 06    | L-field, repeated                                  |
| 4        | 1    | 68    | Start character                                    |
| 5        | 1    | 53/73 | C-field, SND_UD                                    |
| 6        | 1    | xx    | A-field, address                                   |
| 7        | 1    | 51    | CI-field, data send, LSB first                     |
| 8        | 1    | 01    | DIF size, 8 bit integer                            |
| 9        | 1    | 7A    | VIFE Bus Address                                   |
| 10       | 1    | xx    | New primary address                                |
| 11       | 1    | xx    | CS checksum, calculated from C field to last data  |
| 12       | 1    | 16    | Stop character                                     |

### 10.5.3 Change baud rate

The baud rate of the electrical M-Bus interface is set by sending the following command (all values are hexadecimal). The command is not affected by the write protection level set.

After the baud rate has been changed a command must be sent to the meter (any command, for example NKE or REQ\_UD2) that is received correctly by the meter within a certain time (normally 30 seconds) for the meter to keep the new baud rate. Otherwise the meter falls back to use the baud rate that was used before the baud rate change. This functionality is used to prevent changing to a baud rate that doesn't work for some reason.

| Byte No. | Size | Value | Description  |
|----------|------|-------|--|
| 1        | 1    | 68    | Start character                                    |
| 2        | 1    | 03    | L-field, calculated from C field to last user data |
| 3        | 1    | 03    | L-field, repeated                                  |
| 4        | 1    | 68    | Start character                                    |
| 5        | 1    | 53/73 | C-field, SND_UD                                    |
| 6        | 1    | xx    | A-field, address                                   |
| 7        | 1    | Bx    | CI-field, New baud rate (where x=>8..F)            |
| 8        | 1    | xx    | CS checksum, calculated from C field to last data  |



| Byte No. | Size | Value | Description    |
|----------|------|-------|----------------|
| 9        | 1    | 16    | Stop character |

#### 10.5.4 Reset power fail counter

The power fail counter is reset to 0 by sending the following command (all values are hexadecimal). The command is not affected by the write protection level set.

| Byte No. | Size | Value | Description  |
|----------|------|-------|--|
| 1        | 1    | 68    | Start character                                    |
| 2        | 1    | 07    | L-field, calculated from C field to last user data |
| 3        | 1    | 07    | L-field, repeated                                  |
| 4        | 1    | 68    | Start character                                    |
| 5        | 1    | 53/73 | C-field, SND_UD                                    |
| 6        | 1    | xx    | A-field, address                                   |
| 7        | 1    | 51    | CI-field, data send, LSB first                     |
| 8        | 1    | 00    | DIF size, no data                                  |
| 9        | 1    | FF    | VIF next byte is manufacturer specific             |
| 10       | 1    | 98    | VIFE no. of power fails                            |
| 11       | 1    | 07    | VIFE clear   |
| 12       | 1    | xx    | CS checksum, calculated from C field to last data  |
| 13       | 1    | 16    | Stop character                                     |

#### 10.5.5 Set Current transformer (CT) ratio - primary current

The current transformer ratio (CT) primary current is set by sending the following command (all values are hexadecimal). The command is affected by the write protection level set.

| Byte No. | Size | Value   | Description  |
|----------|------|---------|--|
| 1        | 1    | 68      | Start character                                    |
| 2        | 1    | 0a      | L-field, calculated from C field to last user data |
| 3        | 1    | 0a      | L-field, repeated                                  |
| 4        | 1    | 68      | Start character                                    |
| 5        | 1    | 53/73   | C-field, SND_UD                                    |
| 6        | 1    | xx      | A-field, address                                   |
| 7        | 1    | 51      | CI-field, data send, LSB first                     |
| 8        | 1    | 04      | DIF size, 32 bit integer                           |
| 9        | 1    | FF      | VIF next byte is manufacturer specific             |
| 10       | 1    | 20      | VIFE CT ratio primary current                      |
| 11-14    | 4    | xxxxxxx | New CT ratio primary current                       |
| 15       | 1    | xx      | CS checksum, calculated from C field to last data  |
| 16       | 1    | 16      | Stop character                                     |

### 10.5.6 Set voltage transformer (VT) ratio - primary voltage

The voltage transformer ratio (VT) primary voltage is set by sending the following command (all values are hexadecimal). The command is affected by the write protection level set.

| Byte No. | Size | Value   | Description  |
|----------|------|---------|--|
| 1        | 1    | 68      | Start character                                    |
| 2        | 1    | 0a      | L-field, calculated from C field to last user data |
| 3        | 1    | 0a      | L-field, repeated                                  |
| 4        | 1    | 68      | Start character                                    |
| 5        | 1    | 53/73   | C-field, SND_UD                                    |
| 6        | 1    | xx      | A-field, address                                   |
| 7        | 1    | 51      | CI-field, data send, LSB first                     |
| 8        | 1    | 04      | DIF size, 32 bit integer                           |
| 9        | 1    | FF      | VIF next byte is manufacturer specific             |
| 10       | 1    | 21      | VIFE VT ratio primary voltage                      |
| 11-14    | 4    | xxxxxxx | New VT ratio primary voltage                       |
| 15       | 1    | xx      | CS checksum, calculated from C field to last data  |
| 16       | 1    | 16      | Stop character                                     |

### 10.5.7 Set current transformer (CT) ratio - secondary current

The current transformer ratio (CT) secondary current is set by sending the following command (all values are hexadecimal). The command is affected by the write protection level set.

| Byte No. | Size | Value   | Description  |
|----------|------|---------|--|
| 1        | 1    | 68      | Start character                                    |
| 2        | 1    | 0a      | L-field, calculated from C field to last user data |
| 3        | 1    | 0a      | L-field, repeated                                  |
| 4        | 1    | 68      | Start character                                    |
| 5        | 1    | 53/73   | C-field, SND_UD                                    |
| 6        | 1    | xx      | A-field, address                                   |
| 7        | 1    | 51      | CI-field, data send, LSB first                     |
| 8        | 1    | 04      | DIF size, 32 bit integer                           |
| 9        | 1    | FF      | VIF next byte is manufacturer specific             |
| 10       | 1    | 22      | VIFE CT ratio secondary current                    |
| 11-14    | 4    | xxxxxxx | New CT ratio secondary current                     |
| 15       | 1    | xx      | CS checksum, calculated from C field to last data  |
| 16       | 1    | 16      | Stop character                                     |

### 10.5.8 Set voltage transformer (VT) ratio - secondary voltage

The voltage transformer ratio (VT) secondary voltage is set by sending the following command (all values are hexadecimal). The command is affected by the write protection level set.

| Byte No. | Size | Value       | Description  |
|----------|------|-------------|--|
| 1        | 1    | 68          | Start character                                    |
| 2        | 1    | 0A          | L-field, calculated from C field to last user data |
| 3        | 1    | 0A          | L-field, repeated                                  |
| 4        | 1    | 68          | Start character                                    |
| 5        | 1    | 53/73       | C-field, SND_UD                                    |
| 6        | 1    | xx          | A-field, address                                   |
| 7        | 1    | 51          | CI-field, data send, LSB first                     |
| 8        | 1    | 04          | DIF size, 32 bit integer                           |
| 9        | 1    | FF          | VIF next byte is manufacturer specific             |
| 10       | 1    | 23          | VIFE VT ratio secondary voltage                    |
| 11-14    | 4    | xx xx xx xx | New VT ratio secondary voltage                     |
| 15       | 1    | xx          | CS checksum, calculated from C field to last data  |
| 16       | 1    | 16          | Stop character                                     |

### 10.5.9 Select status information

To change the way the status information is sent out the following command is sent (all values are hexadecimal). The command is not affected by the write protection level set.

| Byte No. | Size | Value | Description  |
|----------|------|-------|--|
| 1        | 1    | 68    | Start character                                    |
| 2        | 1    | 07    | L-field, calculated from C field to last user data |
| 3        | 1    | 07    | L-field, repeated                                  |
| 4        | 1    | 68    | Start character                                    |
| 5        | 1    | 53/73 | C-field, SND_UD                                    |
| 6        | 1    | xx    | A-field, address                                   |
| 7        | 1    | 51    | CI-field, data send, LSB first                     |
| 8        | 1    | 01    | DIF size, 8 bit integer                            |
| 9        | 1    | FF    | VIF next byte is manufacturer specific             |
| 10       | 1    | 15    | VIFE status of values (status byte on the values)  |
| 11       | 1    | xx    | 0=never, 1=status if not OK=always                 |
| 12       | 1    | xx    | CS checksum, calculated from C field to last data  |
| 13       | 1    | 16    | Stop character                                     |

### 10.5.10 Reset of stored state for input 1

Reset of stored state for input 1 is performed by sending the following command (all values are hexadecimal). The command is not affected by the write protection level set.

| Byte No. | Size | Value | Description  |
|----------|------|-------|--|
| 1        | 1    | 68    | Start character                                    |
| 2        | 1    | 08    | L-field, calculated from C field to last user data |
| 3        | 1    | 08    | L-field, repeated                                  |
| 4        | 1    | 68    | Start character                                    |
| 5        | 1    | 53/73 | C-field, SND_UD                                    |
| 6        | 1    | xx    | A-field, address                                   |
| 7        | 1    | 51    | CI-field, data send, LSB first                     |
| 8        | 1    | C0    | DIF size, no data, storage number 1                |
| 9        | 1    | 40    | DIFE unit=1  |
| 10       | 1    | FD    | VIF extension of VIF codes                         |
| 11       | 1    | 9B    | VIFE digital input                                 |
| 12       | 1    | 07    | VIFE clear   |
| 13       | 1    | xx    | CS checksum, calculated from C field to last data  |
| 14       | 1    | 16    | Stop character                                     |

### 10.5.11 Reset of stored state for input 2

Reset of stored state for input 2 is performed by sending the following command (all values are hexadecimal). The command is not affected by the write protection level set.

| Byte No. | Size | Value | Description  |
|----------|------|-------|--|
| 1        | 1    | 68    | Start character                                    |
| 2        | 1    | 09    | L-field, calculated from C field to last user data |
| 3        | 1    | 09    | L-field, repeated                                  |
| 4        | 1    | 68    | Start character                                    |
| 5        | 1    | 53/73 | C-field, SND_UD                                    |
| 6        | 1    | xx    | A-field, address                                   |
| 7        | 1    | 51    | CI-field, data send, LSB first                     |
| 8        | 1    | C0    | DIF size, no data, storage number 1                |
| 9        | 1    | 80    | DIFE unit=0  |
| 10       | 1    | 40    | DIFE unit=2  |
| 11       | 1    | FD    | VIF extension of VIF codes                         |
| 12       | 1    | 9B    | VIFE digital input                                 |
| 13       | 1    | 07    | VIFE clear   |
| 14       | 1    | xx    | CS checksum, calculated from C field to last data  |
| 15       | 1    | 16    | Stop character                                     |

### 10.5.12 Reset of stored state for input 3

Reset of stored state for input 3 is performed by sending the following command (all values are hexadecimal). The command is not affected by the write protection level set.

| Byte No. | Size | Value | Description  |
|----------|------|-------|--|
| 1        | 1    | 68    | Start character                                    |
| 2        | 1    | 09    | L-field, calculated from C field to last user data |
| 3        | 1    | 09    | L-field, repeated                                  |
| 4        | 1    | 68    | Start character                                    |
| 5        | 1    | 53/73 | C-field, SND_UD                                    |
| 6        | 1    | xx    | A-field, address                                   |
| 7        | 1    | 51    | CI-field, data send, LSB first                     |
| 8        | 1    | C0    | DIF size, no data, storage number 1                |
| 9        | 1    | C0    | DIFE unit=1  |
| 10       | 1    | 40    | DIFE unit=2  |
| 11       | 1    | FD    | VIF extension of VIF codes                         |
| 12       | 1    | 9B    | VIFE digital input                                 |
| 13       | 1    | 07    | VIFE clear   |
| 14       | 1    | xx    | CS checksum, calculated from C field to last data  |
| 15       | 1    | 16    | Stop character                                     |

### 10.5.13 Reset of stored state for input 4

Reset of stored state for input 4 is performed by sending the following command (all values are hexadecimal). The command is not affected by the write protection level set.

| Byte No. | Size | Value | Description  |
|----------|------|-------|--|
| 1        | 1    | 68    | Start character                                    |
| 2        | 1    | 0A    | L-field, calculated from C field to last user data |
| 3        | 1    | 0A    | L-field, repeated                                  |
| 4        | 1    | 68    | Start character                                    |
| 5        | 1    | 53/73 | C-field, SND_UD                                    |
| 6        | 1    | xx    | A-field, address                                   |
| 7        | 1    | 51    | CI-field, data send, LSB first                     |
| 8        | 1    | C0    | DIF size, no data, storage number 1                |
| 9        | 1    | 80    | DIFE unit=0  |
| 10       | 1    | 80    | DIFE unit=0  |
| 11       | 1    | 40    | DIFE unit=4  |
| 12       | 1    | FD    | VIF extension of VIF codes                         |
| 13       | 1    | 9B    | VIFE digital input                                 |
| 14       | 1    | 07    | VIFE clear   |
| 15       | 1    | xx    | CS checksum, calculated from C field to last data  |
| 16       | 1    | 16    | Stop character                                     |

### 10.5.14 Reset of input counter 1

Reset of input counter 1 is performed by sending the following command (all values are hexadecimal). The command is not affected by the write protection level set.

| Byte No. | Size | Value | Description  |
|----------|------|-------|--|
| 1        | 1    | 68    | Start character                                    |
| 2        | 1    | 08    | L-field, calculated from C field to last user data |
| 3        | 1    | 08    | L-field, repeated                                  |
| 4        | 1    | 68    | Start character                                    |
| 5        | 1    | 53/73 | C-field, SND_UD                                    |
| 6        | 1    | xx    | A-field, address                                   |
| 7        | 1    | 51    | CI-field, data send, LSB first                     |
| 8        | 1    | C0    | DIF size, no data                                  |
| 9        | 1    | 40    | DIFE unit=1  |
| 10       | 1    | FD    | VIF extension of VIF codes                         |
| 11       | 1    | 9B    | VIFE cumulating counters                           |
| 12       | 1    | 07    | VIFE clear   |
| 13       | 1    | xx    | CS checksum, calculated from C field to last data  |
| 14       | 1    | 16    | Stop character                                     |

### 10.5.15 Reset of input counter 2

Reset of input counter 2 is performed by sending the following command (all values are hexadecimal). The command is not affected by the write protection level set.

| Byte No. | Size | Value | Description  |
|----------|------|-------|--|
| 1        | 1    | 68    | Start character                                    |
| 2        | 1    | 09    | L-field, calculated from C field to last user data |
| 3        | 1    | 09    | L-field, repeated                                  |
| 4        | 1    | 68    | Start character                                    |
| 5        | 1    | 53/73 | C-field, SND_UD                                    |
| 6        | 1    | xx    | A-field, address                                   |
| 7        | 1    | 51    | CI-field, data send, LSB first                     |
| 8        | 1    | 80    | DIF size, no data                                  |
| 9        | 1    | 80    | DIFE unit=0  |
| 10       | 1    | 40    | DIFE unit=2  |
| 11       | 1    | FD    | VIF extension of VIF codes                         |
| 12       | 1    | E1    | VIFE cumulating counters                           |
| 13       | 1    | 07    | VIFE clear   |
| 14       | 1    | xx    | CS checksum, calculated from C field to last data  |
| 15       | 1    | 16    | Stop character                                     |

### 10.5.16 Reset of input counter 3

Reset of input counter 3 is performed by sending the following command (all values are hexadecimal). The command is not affected by the write protection level set.

| Byte No. | Size | Value | Description  |
|----------|------|-------|--|
| 1        | 1    | 68    | Start character                                    |
| 2        | 1    | 09    | L-field, calculated from C field to last user data |
| 3        | 1    | 09    | L-field, repeated                                  |
| 4        | 1    | 68    | Start character                                    |
| 5        | 1    | 53/73 | C-field, SND_UD                                    |
| 6        | 1    | xx    | A-field, address                                   |
| 7        | 1    | 51    | CI-field, data send, LSB first                     |
| 8        | 1    | 80    | DIF size, no data                                  |
| 9        | 1    | C0    | DIFE unit=1  |
| 10       | 1    | 40    | DIFE unit=2  |
| 11       | 1    | FD    | VIF extension of VIF codes                         |
| 12       | 1    | E1    | VIFE cumulating counters                           |
| 13       | 1    | 07    | VIFE clear   |
| 14       | 1    | xx    | CS checksum, calculated from C field to last data  |
| 15       | 1    | 16    | Stop character                                     |

### 10.5.17 Reset of input counter 4

Reset of input counter 4 is performed by sending the following command (all values are hexadecimal). The command is not affected by the write protection level set.

| Byte No. | Size | Value | Description  |
|----------|------|-------|--|
| 1        | 1    | 68    | Start character                                    |
| 2        | 1    | 0A    | L-field, calculated from C field to last user data |
| 3        | 1    | 0A    | L-field, repeated                                  |
| 4        | 1    | 68    | Start character                                    |
| 5        | 1    | 53/73 | C-field, SND_UD                                    |
| 6        | 1    | xx    | A-field, address                                   |
| 7        | 1    | 51    | CI-field, data send, LSB first                     |
| 8        | 1    | 80    | DIF size, no data                                  |
| 9        | 1    | 80    | DIFE unit=0  |
| 10       | 1    | 80    | DIFE unit=0  |
| 11       | 1    | 40    | DIFE unit=4  |
| 12       | 1    | FD    | VIF extension of VIF codes                         |
| 13       | 1    | E1    | VIFE cumulating counters                           |
| 14       | 1    | 07    | VIFE clear   |
| 15       | 1    | xx    | CS checksum, calculated from C field to last data  |
| 16       | 1    | 16    | Stop character                                     |

### 10.5.18 Set output 1

Setting the state of output 1 is performed by sending the following command (all values are hexadecimal). The command is not affected by the write protection level set.

| Byte No. | Size | Value | Description  |
|----------|------|-------|--|
| 1        | 1    | 68    | Start character                                    |
| 2        | 1    | 08    | L-field, calculated from C field to last user data |
| 3        | 1    | 08    | L-field, repeated                                  |
| 4        | 1    | 68    | Start character                                    |
| 5        | 1    | 53/73 | C-field, SND_UD                                    |
| 6        | 1    | xx    | A-field, address                                   |
| 7        | 1    | 51    | CI-field, data send, LSB first                     |
| 8        | 1    | 81    | DIF size, 8 bit integer                            |
| 9        | 1    | 40    | DIFE unit=1  |
| 10       | 1    | FD    | VIF extension of VIF codes                         |
| 11       | 1    | 1A    | VIFE digital output                                |
| 12       | 1    | xx    | output 1, new state                                |
| 13       | 1    | xx    | CS checksum, calculated from C field to last data  |
| 14       | 1    | 16    | Stop character                                     |

### 10.5.19 Set output 2

Setting the state of output 2 is performed by sending the following command (all values are hexadecimal). The command is not affected by the write protection level set.

| Byte No. | Size | Value | Description  |
|----------|------|-------|--|
| 1        | 1    | 68    | Start character                                    |
| 2        | 1    | 09    | L-field, calculated from C field to last user data |
| 3        | 1    | 09    | L-field, repeated                                  |
| 4        | 1    | 68    | Start character                                    |
| 5        | 1    | 53/73 | C-field, SND_UD                                    |
| 6        | 1    | xx    | A-field, address                                   |
| 7        | 1    | 51    | CI-field, data send, LSB first                     |
| 8        | 1    | 81    | DIF size, 8 bit integer                            |
| 9        | 1    | 80    | DIFE unit=0  |
| 10       | 1    | 40    | DIFE unit=2  |
| 11       | 1    | FD    | VIF extension of VIF codes                         |
| 12       | 1    | 1A    | VIFE digital output                                |
| 13       | 1    | xx    | output 2, new state                                |
| 14       | 1    | xx    | CS checksum, calculated from C field to last data  |
| 15       | 1    | 16    | Stop character                                     |



### 10.5.20 Set output 3

Setting the state of output 3 is performed by sending the following command (all values are hexadecimal). The command is not affected by the write protection level set.

| Byte No. | Size | Value | Description  |
|----------|------|-------|--|
| 1        | 1    | 68    | Start character                                    |
| 2        | 1    | 09    | L-field, calculated from C field to last user data |
| 3        | 1    | 09    | L-field, repeated                                  |
| 4        | 1    | 68    | Start character                                    |
| 5        | 1    | 53/73 | C-field, SND_UD                                    |
| 6        | 1    | xx    | A-field, address                                   |
| 7        | 1    | 51    | CI-field, data send, LSB first                     |
| 8        | 1    | 81    | DIF size, 8 bit integer                            |
| 9        | 1    | C0    | DIFE unit=1  |
| 10       | 1    | 40    | DIFE unit=2  |
| 11       | 1    | FD    | VIF extension of VIF codes                         |
| 12       | 1    | 1A    | VIFE digital output                                |
| 13       | 1    | xx    | output 3, new state                                |
| 14       | 1    | xx    | CS checksum, calculated from C field to last data  |
| 15       | 1    | 16    | Stop character                                     |

### 10.5.21 Set output 4

Setting the state of output 4 is performed by sending the following command (all values are hexadecimal). The command is not affected by the write protection level set.

| Byte No. | Size | Value | Description  |
|----------|------|-------|--|
| 1        | 1    | 68    | Start character                                    |
| 2        | 1    | 0A    | L-field, calculated from C field to last user data |
| 3        | 1    | 0A    | L-field, repeated                                  |
| 4        | 1    | 68    | Start character                                    |
| 5        | 1    | 53/73 | C-field, SND_UD                                    |
| 6        | 1    | xx    | A-field, address                                   |
| 7        | 1    | 51    | CI-field, data send, LSB first                     |
| 8        | 1    | 81    | DIF size, 8 bit integer                            |
| 9        | 1    | 80    | DIFE unit=0  |
| 10       | 1    | 80    | DIFE unit=0  |
| 11       | 1    | 40    | DIFE unit=4  |
| 12       | 1    | FD    | VIF extension of VIF codes                         |
| 13       | 1    | 1A    | VIFE digital output                                |
| 14       | 1    | xx    | output 4, new state                                |
| 15       | 1    | xx    | CS checksum, calculated from C field to last data  |
| 16       | 1    | 16    | Stop character                                     |

### 10.5.22 Reset power outage time

Reset of power outage time is performed by sending the following command (all values are hexadecimal). The command is not affected by the write protection level set.

| Byte No. | Size | Value | Description  |
|----------|------|-------|--|
| 1        | 1    | 68    | Start character                                    |
| 2        | 1    | 07    | L-field, calculated from C field to last user data |
| 3        | 1    | 07    | L-field, repeated                                  |
| 4        | 1    | 68    | Start character                                    |
| 5        | 1    | 53/73 | C-field, SND_UD                                    |
| 6        | 1    | xx    | A-field, address                                   |
| 7        | 1    | 51    | CI-field, data send, LSB first                     |
| 8        | 1    | 00    | DIF size, no data                                  |
| 9        | 1    | FF    | VIF next byte is manufacturer specific             |
| 10       | 1    | EC    | VIFE power outage time                             |
| 11       | 1    | 07    | VIFE clear   |
| 12       | 1    | xx    | CS checksum, calculated from C field to last data  |
| 13       | 1    | 16    | Stop character                                     |

### 10.5.23 Send password

Password is sent with the following command (all values are hexadecimal).

| Byte No. | Size | Value            | Description  |
|----------|------|------------------|--|
| 1        | 1    | 68               | Start character                                    |
| 2        | 1    | 0E               | L-field, calculated from C field to last user data |
| 3        | 1    | 0E               | L-field, repeated                                  |
| 4        | 1    | 68               | Start character                                    |
| 5        | 1    | 53/73            | C-field, SND_UD                                    |
| 6        | 1    | Xx               | A-field, address                                   |
| 7        | 1    | 51               | CI-field, data send, LSB first                     |
| 8        | 1    | 07               | DIF size, 8 byte integer                           |
| 9        | 1    | FD               | VIF extension of VIF codes                         |
| 10       | 1    | 16               | VIFE password                                      |
| 11-18    | 8    | xxxxxxxxxxxxxxxx | Password   |
| 19       | 1    | xx               | CS checksum, calculated from C field to last data  |
| 20       | 1    | 16               | Stop character                                     |

### 10.5.24 Set password

Password is set by sending the following command (all values are hexadecimal).



**Note** – If the meter is password protected the old password must be sent before a new can be set.

| Byte No. | Size | Value           | Description  |
|----------|------|-----------------|--|
| 1        | 1    | 68              | Start character                                    |
| 2        | 1    | 0F              | L-field, calculated from C field to last user data |
| 3        | 1    | 0F              | L-field, repeated                                  |
| 4        | 1    | 68              | Start character                                    |
| 5        | 1    | 53/73           | C-field, SND_UD                                    |
| 6        | 1    | xx              | A-field, address                                   |
| 7        | 1    | 51              | CI-field, data send, LSB first                     |
| 8        | 1    | 07              | DIF size, 8 byte integer                           |
| 9        | 1    | FD              | VIF extension of VIF codes                         |
| 10       | 1    | 96              | VIFE password                                      |
| 11       | 1    | 00              | VIFE write (replace)                               |
| 12-19    | 8    | xxxxxxxxxxxxxxx | Password   |
| 20       | 1    | xx              | CS checksum, calculated from C field to last data  |
| 21       | 1    | 16              | Stop character                                     |

10.5.25 Set date and time

Date and time is set by sending the following command (all values are hexadecimal). The command is affected by the write protection level set.



**Note** – Before sending the command an NKE should be sent. If the meter is in the middle of a special data readout process it will not respond to the set date and time command.

| Byte No. | Size | Value       | Description  |
|----------|------|-------------|--|
| 1        | 1    | 68          | Start character                                    |
| 2        | 1    | 0B          | L-field, calculated from C field to last user data |
| 3        | 1    | 0B          | L-field, repeated                                  |
| 4        | 1    | 68          | Start character                                    |
| 5        | 1    | 53/73       | C-field, SND_UD                                    |
| 6        | 1    | xx          | A-field, address                                   |
| 7        | 1    | 51          | CI-field, data send, LSB first                     |
| 8        | 1    | 0E          | DIF size, 12 digit BCD                             |
| 9        | 1    | 6D          | VIF time/date                                      |
| 10-15    | 6    | xxxxxxxxxxx | Time and date (sec, min, hour, day, month, year)   |
| 16       | 1    | xx          | CS checksum, calculated from C field to last data  |
| 17       | 1    | 16          | Stop character                                     |

### 10.5.26 Set date

The date is set by sending the following command (all values are hexadecimal). The command is affected by the write protection level set.

| Byte No. | Size | Value | Description   |
|----------|------|-------|---|
| 1        | 1    | 68    | Start character   |
| 2        | 1    | 07    | L-field, calculated from C field to last user data        |
| 3        | 1    | 07    | L-field, repeated   |
| 4        | 1    | 68    | Start character   |
| 5        | 1    | 53/73 | C-field, SND_UD   |
| 6        | 1    | xx    | A-field, address  |
| 7        | 1    | 51    | CI-field, data send, LSB first                            |
| 8        | 1    | 02    | DIF size, 16 bit integer                                  |
| 9        | 1    | 6C    | VIF date  |
| 10-11    | 1    | xxxx  | Date (day,month,year coded accorded to M-Bus data type G) |
| 12       | 1    | xx    | CS checksum, calculated from C field to last data         |
| 13       | 1    | 16    | Stop character  |

### 10.5.27 Reset demand, previous values, load profile and logs

All data for demand, previous values, load profile and logs is cleared by sending the following command (all values are hexadecimal). The command is affected by the write protection level set.

| Byte No. | Size | Value | Description  |
|----------|------|-------|--|
| 1        | 1    | 68    | Start character  |
| 2        | 1    | 08    | L-field, calculated from C field to last user data   |
| 3        | 1    | 08    | L-field, repeated  |
| 4        | 1    | 68    | Start character  |
| 5        | 1    | 53/73 | C-field, SND_UD  |
| 6        | 1    | xx    | A-field, address   |
| 7        | 1    | 51    | CI-field, data send, LSB first   |
| 8        | 1    | 00    | DIF size, no data  |
| 9        | 1    | FF    | VIF next byte is manufacturer specific   |
| 10       | 1    | F9    | VIF extension of manufacturer specific VIFE's, next VIFE specifies actual meaning  |
| 11       | 1    | xx    | VIFE specifies data to be cleared: <ul style="list-style-type: none"> <li>• 82: Demand</li> <li>• 83: Previous values</li> <li>• 84: Load profile</li> <li>• AE: System log</li> <li>• B0: Net quality log</li> <li>• B2: Event log</li> </ul> |
| 12       | 1    | 07    | VIFE clear   |
| 13       | 1    | xx    | CS checksum, calculated from C field to last data  |

| Byte No. | Size | Value | Description    |
|----------|------|-------|----------------|
| 14       | 1    | 16    | Stop character |

### 10.5.28 Reset resettable active energy import

Reset of resettable active energy import is performed by sending the following command (all values are hexadecimal). The command is affected by the write protection level set.

| Byte No. | Size | Value | Description  |
|----------|------|-------|--|
| 1        | 1    | 68    | Start character                                    |
| 2        | 1    | 08    | L-field, calculated from C field to last user data |
| 3        | 1    | 08    | L-field, repeated                                  |
| 4        | 1    | 68    | Start character                                    |
| 5        | 1    | 53/73 | C-field, SND_UD                                    |
| 6        | 1    | xx    | A-field, address                                   |
| 7        | 1    | 51    | CI-field, data send, LSB first                     |
| 8        | 1    | 00    | DIF size, no data                                  |
| 9        | 1    | 84    | VIFE specifying energy                             |
| 10       | 1    | FF    | VIFE next byte is manufacturer specific            |
| 11       | 1    | F2    | Resettable registers                               |
| 12       | 1    | 07    | VIFE clear   |
| 13       | 1    | xx    | CS checksum, calculated from C field to last data  |
| 14       | 1    | 16    | Stop character                                     |

### 10.5.29 Reset resettable active energy export

Reset of resettable active energy export is performed by sending the following command (all values are hexadecimal). The command is affected by the write protection level set.

| Byte No. | Size | Value | Description  |
|----------|------|-------|--|
| 1        | 1    | 68    | Start character                                    |
| 2        | 1    | 09    | L-field, calculated from C field to last user data |
| 3        | 1    | 09    | L-field, repeated                                  |
| 4        | 1    | 68    | Start character                                    |
| 5        | 1    | 53/73 | C-field, SND_UD                                    |
| 6        | 1    | xx    | A-field, address                                   |
| 7        | 1    | 51    | CI-field, data send, LSB first                     |
| 8        | 1    | 80    | DIF size, no data                                  |
| 9        | 1    | 40    | DIFE, unit=1                                       |
| 10       | 1    | 84    | VIFE specifying energy                             |
| 11       | 1    | FF    | VIFE next byte is manufacturer specific            |
| 12       | 1    | F2    | Resettable registers                               |
| 13       | 1    | 07    | VIFE clear   |
| 14       | 1    | xx    | CS checksum, calculated from C field to last data  |

| Byte No. | Size | Value | Description    |
|----------|------|-------|----------------|
| 15       | 1    | 16    | Stop character |

### 10.5.30 Reset resettable reactive energy import

Reset of resettable active energy export is performed by sending the following command (all values are hexadecimal). The command is affected by the write protection level set.

| Byte No. | Size | Value | Description  |
|----------|------|-------|--|
| 1        | 1    | 68    | Start character                                    |
| 2        | 1    | 08    | L-field, calculated from C field to last user data |
| 3        | 1    | 08    | L-field, repeated                                  |
| 4        | 1    | 68    | Start character                                    |
| 5        | 1    | 53/73 | C-field, SND_UD                                    |
| 6        | 1    | xx    | A-field, address                                   |
| 7        | 1    | 51    | CI-field, data send, LSB first                     |
| 8        | 1    | 80    | DIF size, no data                                  |
| 9        | 1    | 80    | DIFE, unit=0                                       |
| 10       | 1    | 40    | DIFE unit=2  |
| 11       | 1    | 84    | VIFE specifying energy                             |
| 12       | 1    | FF    | VIFE next byte is manufacturer specific            |
| 13       | 1    | F2    | Resettable registers                               |
| 14       | 1    | 07    | VIFE clear   |
| 15       | 1    | xx    | CS checksum, calculated from C field to last data  |
| 16       | 1    | 16    | Stop character                                     |

### 10.5.31 Reset resettable reactive energy export

Reset of resettable active energy export is performed by sending the following command (all values are hexadecimal). The command is affected by the write protection level set.

| Byte No. | Size | Value | Description  |
|----------|------|-------|--|
| 1        | 1    | 68    | Start character                                    |
| 2        | 1    | 0A    | L-field, calculated from C field to last user data |
| 3        | 1    | 0A    | L-field, repeated                                  |
| 4        | 1    | 68    | Start character                                    |
| 5        | 1    | 53/73 | C-field, SND_UD                                    |
| 6        | 1    | xx    | A-field, address                                   |
| 7        | 1    | 51    | CI-field, data send, LSB first                     |
| 8        | 1    | 80    | DIF size, no data                                  |
| 9        | 1    | C0    | DIFE, unit=1                                       |
| 10       | 1    | 40    | DIFE unit=3  |
| 11       | 1    | 84    | VIFE specifying energy                             |
| 12       | 1    | FF    | VIFE next byte is manufacturer specific            |

| Byte No. | Size | Value | Description                                       |
|----------|------|-------|---|
| 13       | 1    | F2    | Resettable registers                              |
| 14       | 1    | 07    | VIFE clear  |
| 15       | 1    | xx    | CS checksum, calculated from C field to last data |
| 16       | 1    | 16    | Stop character                                    |

### 10.5.32 Freeze demand

The demand values will be frozen and a new period will be started by sending the following command (all values are hexadecimal). The command is affected by the write protection level set.

| Byte No. | Size | Value | Description   |
|----------|------|-------|---|
| 1        | 1    | 68    | Start character   |
| 2        | 1    | 08    | L-field, calculated from C field to last user data                                |
| 3        | 1    | 08    | L-field, repeated   |
| 4        | 1    | 68    | Start character   |
| 5        | 1    | 53/73 | C-field, SND_UD   |
| 6        | 1    | xx    | A-field, address  |
| 7        | 1    | 51    | CI-field, data send, LSB first  |
| 8        | 1    | 00    | DIF size, no data   |
| 9        | 1    | FF    | VIF next byte is manufacturer specific  |
| 10       | 1    | F9    | VIF extension of manufacturer specific vife's, next vife specifies actual meaning |
| 11       | 1    | 82    | VIFE specifying demand  |
| 12       | 1    | 0B    | VIFE freeze   |
| 13       | 1    | xx    | CS checksum, calculated from C field to last data                                 |
| 14       | 1    | 16    | Stop character  |

### 10.5.33 Set write access level

The write access level is set by sending the following command (all values are hexadecimal). The command is affected by the write protection level set.

| Byte No. | Size | Value | Description   |
|----------|------|-------|---|
| 1        | 1    | 68    | Start character   |
| 2        | 1    | 07    | L-field, calculated from C field to last user data      |
| 3        | 1    | 07    | L-field, repeated                                       |
| 4        | 1    | 68    | Start character   |
| 5        | 1    | 53/73 | C-field, SND_UD   |
| 6        | 1    | xx    | A-field, address  |
| 7        | 1    | 51    | CI-field, data send, LSB first                          |
| 8        | 1    | 01    | DIF size, 8 bit integer                                 |
| 9        | 1    | FF    | VIF next byte is manufacturer specific                  |
| 10       | 1    | 6A    | VIFE write control                                      |
| 11       | 1    | xx    | Write control (1: Closed, 2: Open by password, 3: Open) |

| Byte No. | Size | Value | Description                                       |
|----------|------|-------|---|
| 12       | 1    | xx    | CS checksum, calculated from C field to last data |
| 13       | 1    | 16    | Stop character                                    |

### 10.5.34 Set tariff source

Tariffs can be controlled by inputs, communication or internal clock.

The tariff source is set by sending the following command (all values are hexadecimal). The command is affected by the write protection level set.

| Byte No. | Size | Value | Description   |
|----------|------|-------|---|
| 1        | 1    | 68    | Start character   |
| 2        | 1    | 08    | L-field, calculated from C field to last user data                                |
| 3        | 1    | 08    | L-field, repeated   |
| 4        | 1    | 68    | Start character   |
| 5        | 1    | 53/73 | C-field, SND_UD   |
| 6        | 1    | xx    | A-field, address  |
| 7        | 1    | 51    | CI-field, data send, LSB first  |
| 8        | 1    | 01    | DIF size, 8 bit integer   |
| 9        | 1    | FF    | VIF next byte is manufacturer specific  |
| 10       | 1    | F9    | VIF extension of manufacturer specific VIFE's, next VIFE specifies actual meaning |
| 11       | 1    | 06    | VIFE tariff source  |
| 12       | 1    | xx    | Tariff source (0: Internal clock, 1: Communication command, 2: Inputs)            |
| 13       | 1    | xx    | CS checksum, calculated from C field to last data                                 |
| 14       |      | 16    | Stop character  |

### 10.5.35 Set CO2 conversion factor

The co2 conversion factor is set by sending the following command (all values are hexadecimal). The command is not affected by the write protection level set.

| Byte No. | Size | Value   | Description  |
|----------|------|---------|--|
| 1        | 1    | 68      | Start character                                    |
| 2        | 1    | 0A      | L-field, calculated from C field to last user data |
| 3        | 1    | 0A      | L-field, repeated                                  |
| 4        | 1    | 68      | Start character                                    |
| 5        | 1    | 53/73   | C-field, SND_UD                                    |
| 6        | 1    | xx      | A-field, address                                   |
| 7        | 1    | 51      | CI-field, data send, LSB first                     |
| 8        | 1    | 04      | DIF size, 32 bit integer                           |
| 9        | 1    | FF      | VIF next byte is manufacturer specific             |
| 10       | 1    | 24      | VIFE CO2 conversion factor in g/kWh                |
| 11-14    | 4    | xxxxxxx | CO2 conversion factor                              |



| Byte No. | Size | Value | Description                                       |
|----------|------|-------|---|
| 15       | 1    | xx    | CS checksum, calculated from C field to last data |
| 16       | 1    | 16    | Stop character                                    |

---

### 10.5.36 Set currency conversion factor

The currency conversion factor is set by sending the following command (all values are hexadecimal). The command is not affected by the write protection level set.

| Byte No. | Size | Value   | Description  |
|----------|------|---------|--|
| 1        | 1    | 68      | Start character  |
| 2        | 1    | 0A      | L-field, calculated from C field to last user data         |
| 3        | 1    | 0A      | L-field, repeated  |
| 4        | 1    | 68      | Start character  |
| 5        | 1    | 53/73   | C-field, SND_UD  |
| 6        | 1    | xx      | A-field, address   |
| 7        | 1    | 51      | CI-field, data send, LSB first                             |
| 8        | 1    | 04      | DIF size, 32 bit integer                                   |
| 9        | 1    | FF      | VIF next byte is manufacturer specific                     |
| 10       | 1    | 25      | VIFE currency conversion factor                            |
| 11-14    | 4    | xxxxxxx | Currency conversion factor in currency/kWh with 3 decimals |
| 15       | 1    | xx      | CS checksum, calculated from C field to last data          |
| 16       | 1    | 16      | Stop character   |

---



## Chapter 11: Troubleshooting

---

### Overview

This chapter describes the error codes the warnings and the information that can be received from the meter and hints of what to check to find installation errors.

---

### 11.1 Error, warnings and information codes

#### Error codes

---

| Error code | Description   |
|------------|---|
| E 40       | Audit error log   |
| E 41       | Program CRC error   |
| E 42       | Persistent storage CRC error  |
| E 43       |   |
| E 44       |   |
| E 45       |   |
| E 46       |   |
| E 47       |   |
| E 48       |   |
| E 49       |   |
| E 50       |   |
| E 51       | Zero level for voltage/current signals incorrect (not $V_{ref}/2$ ) |
| E 52       | Temperature sensor error  |

#### Warnings

---

| Warning | Description                                    |
|---------|--|
| W 1000  | U1 missing                                     |
| W 1001  | U2 missing                                     |
| W 1002  | U3 missing                                     |
| W 1003  | Phase connected to neutral                     |
| W 1004  | Negative power element 1                       |
| W 1005  | Negative power element 2                       |
| W 1006  | Negative power element 3                       |
| W 1007  | Negative power total                           |
| W 1008  | Frequency outside of specification             |
| W 1009  | External input signal outside of specification |
| W 1010  | Date not set                                   |
| W 1011  | Time not set                                   |

---

### Information

---

| Information | Description     |
|-------------|-----------------|
| I 2012      | Alarm 1 active  |
| ...         | ...             |
| I 2037      | Alarm 25 active |
| ...         | ...             |
| I 2054      | Pulses merged   |

---

### Error investigation

If the energy consumption is suspected to be wrong it is recommended to check that the voltage, current and power (under the menu Instantaneous Values) have expected values. If the current and power values are low in a transformer connected meter check that the CT ratio is correctly set and that the secondary terminals are not short circuited (which they can be at installation to avoid high secondary voltages before or during installation of the meter).

If the negative power warning are active check that the current direction are correct. In a transformer connected meter check that the current transformer is connected with correct polarity on both the primary and the secondary side and that the voltage connections are correct.

---

