

connector - with TE screw terminals, for harsh applications



Product description	
BALS-Prd.-Nr	3184
EAN	4024941031844
product category (PG)	TE connector Multi-Grip Cable gland
current (A)	63A
number of poles (P99)	4p
number of poles (P)	3P+PE
position of earth contact (H)	9 h
voltage (V)	200 up to 250V

Product description	
frequency (HZ)	50 and 60Hz
protection degree (SA)	IP67
colour code 1 (KF1)	blue RAL 5015
Colour of appliance	Hinged lid blue, Bayonet ring grey, Housing cover grey, Cable gland grey, Collar grey
connection design (AT)	screw terminal as box terminal with Kontex-contact
maximum conductor size (LQ)	16,0 qmm
cable entry (KE)	Cable gland
Height	251mm
Width	110mm
Depth	115mm
material of enclosure (GM)	Polyamide
contact	The contact carrier is made of high temperature resistant material, the contacts are brass nickel plated

Additional technical information	
	For cable diameter from 16 up to max. 36 mm, Screwless housing connection, Multi-Grip cable gland with gasket, integrated cable clamp and additional water evacuation openings

Logistics data	
Weight/pcs	0.71 kg / Piece
Packaging	Bag
Content amount	1 ST

Logistics data	
EAN	4024941031844
Length	115 mm
Width	110 mm
Height	251 mm
Weight	0.711 kg
Volume	3,175.15 ccm
Packaging	Carton
Content amount	5 ST
EAN	4024941952651
Length	325 mm
Width	217 mm
Height	210 mm
Weight	3.756 kg
Volume	13,588.4 ccm

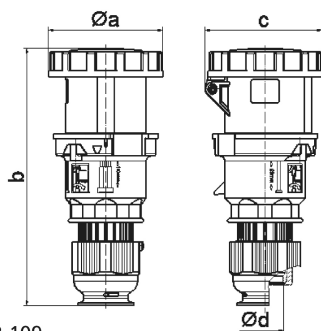

	63	63	63			
Ampere	3	4	5			
Polzahl	3	4	5			
a ø	110,0	110,0	110,0			
b	251,0	251,0	251,0			
c	113,0	113,0	113,0			
d ø	36,0	36,0	36,0			
Leiter mm ² min	6	6	6			
Leiter mm ² max	16	16	16			