

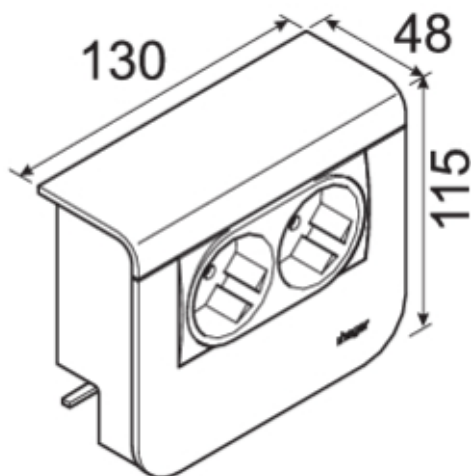

2xKAT.6 FOR SL 55mm ALU

SL20055907D1



Tekniske data

Virkestoff	forskjellige materialer
Halogenfri	1
Tilpasset med	Datauttak
Farge	Aluminium
Arbeidstemperatur	-5 til 65 °C