

C-ES Cable to Vertical Flange Clamp – C12ES (337000)

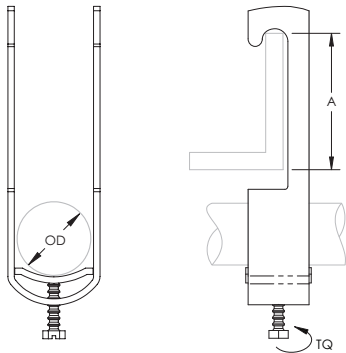

- Supports multiple runs of cable
- Attaches to beam flanges, angle iron, joists and other structural supports



Part Number	C12ES
Article Number	337000
Material	Steel
Finish	Hot-Dip Galvanized
Outer Diameter (OD)	6 – 12 mm
A	43 mm
Torque [TQ]	2 N-m
Standard Packaging Quantity	100 pc
UPC	78285681177
EAN-13	8711893005806

Screw is electrogalvanized on clamps that have an outer diameter of 40 mm or less.

WARNING

nVent products shall be installed and used only as indicated in nVent's product instruction sheets and training materials. Instruction sheets are available at www.erico.com and from your nVent customer service representative. Improper installation, misuse, misapplication or other failure to completely follow nVent's instructions and warnings may cause product malfunction, property damage, serious bodily injury and death and/or void your warranty.

© 2021 nVent All rights reserved

nVent, nVent CADDY, nVent ERICO, nVent ERIFLEX and nVent LENTON are owned by nVent or its global affiliates.

All other trademarks are the property of their respective owners. nVent reserves the right to change specifications without prior notice.

