

# xEffect - Industrial Switchgear Range Residual Current Devices FRCdM











Catalog



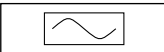

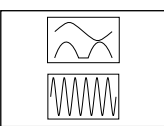

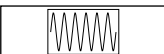
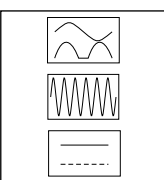
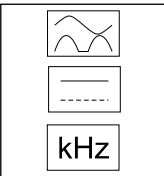
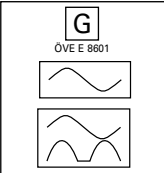
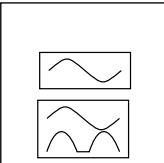
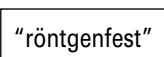



















Powering Business Worldwide

**Residual Current Devices - General Data**

**Short description of the most important RCD types**

Symbol	Description
	Eaton standard. Suitable for outdoor installation (distribution boxes for outdoor installation and building sites) up to -25° C.
	Conditionally surge-current proof (>250 A, 8/20 µs) for general application.
	Type AC: AC current sensitive RCCB
	Type A: AC and pulsating DC current sensitive RCCB, not affected by smooth DC fault currents up to 6 mA
	Type F: AC and pulsating DC current sensitive RCCB, trips also at frequency mixtures (10 Hz, 50 Hz, 1000 Hz), min. 10 ms time-delayed, min. 3 kA surge current proof, higher load capacity with smooth DC fault currents up to 10 mA
	Frequency range up to 20 kHz
	Trips also at frequency mixtures (10 Hz, 50 Hz, 1000 Hz)
	Type B: All-current sensitive RCD switchgear for applications where DC fault currents may occur. Non-selective, non-delayed. Protection against all kinds of fault currents.
	Type B+: All-current sensitive RCD switchgear for applications where DC fault currents may occur. Non-selective, non-delayed. Protection against all kinds of fault currents. Provides enhanced fire safety.
	RCD of type G (min 10 ms time delay) surge current-proof up to 3 kA. For system components where protection against unwanted tripping is needed to avoid personal injury and damage to property. Also for systems involving long lines with high capacitive reactance. Some versions are sensitive to pulsating DC. Some versions are available in all-current sensitive design.
	RCD of type S (selective, min 40 ms time delay) surge current-proof up to 5 kA. Mainly used as main switch, as well as in combination with surge arresters. This is the only RCD suitable for series connection with other types if the rated tripping current of the downstream RCD does not exceed one third of the rated tripping current of the device of type S. Some versions are sensitive to pulsating DC. Some versions are available in all-current sensitive design.
	„X-ray-proof“, for avoiding unwanted tripping caused by x-ray devices.
	„Frequency converter-proof“, for avoiding unwanted tripping caused by frequency converters, speed-controlled drives, etc.

## Kind of residual current and correct use of RCD Types

Kind of current	Current profile	Correct use / application field of RCCB types						Tripping current
		AC	A	F	B	/ B+		
Sinusoidal AC residual current								0.5 to 1.0 $I_{\Delta n}$
Pulsating DC residual current (positive or negative half-wave)		-						0.35 to 1.4 $I_{\Delta n}$
Cut half-wave current		-						Lead angle 90°: 0.25 to 1.4 $I_{\Delta n}$ Lead angle 135°: 0.11 to 1.4 $I_{\Delta n}$
Half-wave with smooth DC current of 6 mA		-						max. 1.4 $I_{\Delta n}$ + 6 mA
Half-wave with smooth DC current of 10 mA		-	-					max. 1.4 $I_{\Delta n}$ + 10 mA
Smooth DC current		-	-	-				0.5 to 2.0 $I_{\Delta n}$

## Tripping time

## Break time and non-actuating time for alternating residual currents (r.m.s. values) for type AC and A RCCB

Classification	$I_{\Delta n}$ mA		$I_{\Delta n}$	$2xI_{\Delta n}$	$5xI_{\Delta n}$	$5 x I_{\Delta n}$ or <b>0.25A</b>	<b>500A</b>
Standard RCD Conditionally surge current-proof 250 A	≤30	Max. tripping time (s)	0.3	0.15		0.04	0.04
Standard RCD Conditionally surge current-proof 250 A	>30	Max. tripping time (s)	0.3	0.15	0.04		0.04
RCCB Type G (Short-time-delay) Surge current-proof 3 kA	30	Min. non actuating time(s) Max. tripping time (s)	0.01 0.3	0.01 0.15		0.01 0.04	0.01 0.04
RCCB Type G (Short-time-delay) Surge current-proof 3 kA	>30	Min. non actuating time(s) Max. tripping time (s)	0.01 0.3	0.01 0.15	0.01 0.04		0.01 0.04
RCCB Type S (Selective) Surge current-proof 5 kA	>30	Min. non actuating time(s) Max. tripping time (s)	0.13 0.5	0.06 0.2	0.05 0.15		0.04 0.15

## Break time for half-wave pulsating residual currents (r.m.s. values) for type A RCCB

Classification	$I_{\Delta n}$ mA		$1.4xI_{\Delta n}$	$2xI_{\Delta n}$	$2.8xI_{\Delta n}$	$4xI_{\Delta n}$	$7 x I_{\Delta n}$	<b>0.35 A</b>	<b>0.5 A</b>	<b>350A</b>
Standard RCD Conditionally surge current-proof 250 A	<30	Max. tripping time (s)		0.3		0.15			0.04	0.04
Standard RCD Conditionally surge current-proof 250 A	30	Max. tripping time (s)	0.3		0.15			0.04		0.04
Standard RCD Conditionally surge current-proof 250 A	>30	Max. tripping time (s)	0.3		0.15		0.04			0.04
RCCB Type G (Short-time-delay) Surge current-proof 3 kA	30	Max. tripping time (s)	0.3		0.15			0.04		0.04
RCCB Type G (Short-time-delay) Surge current-proof 3 kA	>30	Max. tripping time (s)	0.3		0.15		0.04			0.04
RCCB Type S (Selective) Surge current-proof 5 kA	>30	Max. tripping time (s)	0.5		0.2		0.15			0.15

**Tripping Characteristics (IEC/EN 61008)**

**Tripping characteristics, tripping time range and selectivity of instantaneous, surge current-proof „G“ and surge current-proof - selective „S“ residual current devices.**

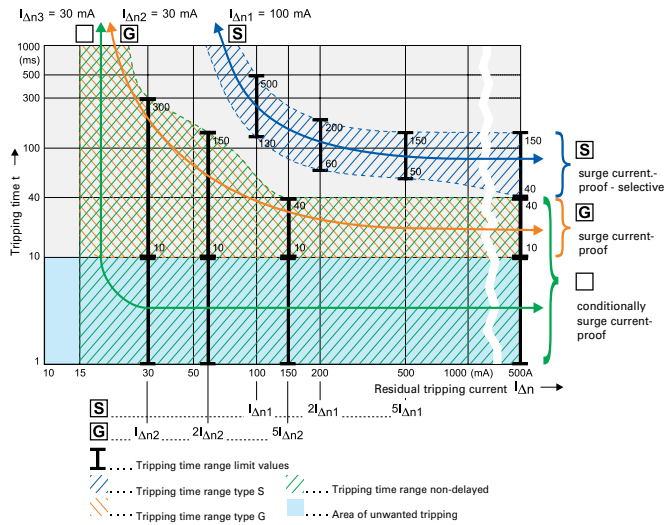

**IEC 60364-4-41** deals with additional protection: The use of RCDs with a rated residual operating current not exceeding 30 mA, is recognized in a.c. systems as additional protection in the event of failure of the provision for basic protection and/or the provision for fault protection or carelessness by users.

**This means when using RCDs for fault current/residual current protection two RCDs must be connected in series.**

**Testing:**

RCDs with tripping time delay (Types -G and -S) may be function tested with conventional testing equipment which must be set according to the instructions for operation of the testing device. Due to reasons inherent in the measuring process, the tripping time determined in this way may be longer than expected in accordance with the specifications of the manufacturer of the measuring instrument.

However, the device is ok if the result of measurement is within the time range specified by the manufacturer of the measuring instrument.

### Hints for the application of our frequency converter-proof RCDs:

Due to the currents flowing off through the filters (designated  $I_F$ ), the sum of currents through the RCD is not exactly zero, which causes unwanted tripping.

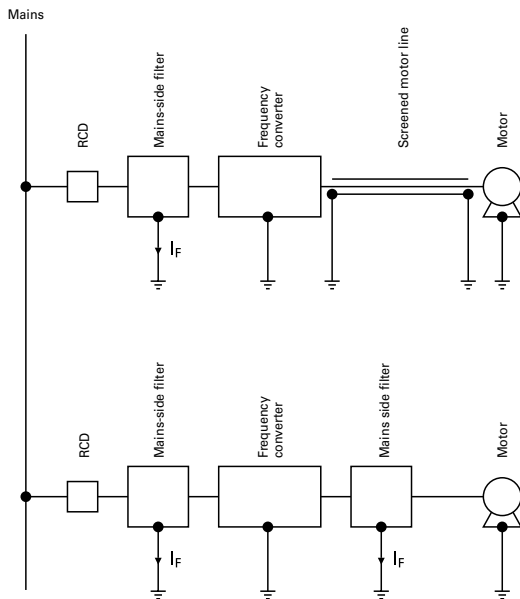

### Tripping characteristic

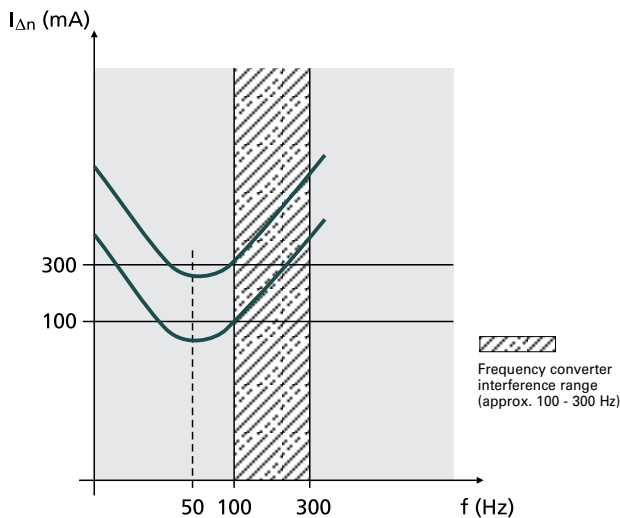

Frequency converters are used in a wide variety of systems and equipment requiring variable speed, such as lifts, escalators, conveyor belts, and large washing machines. Using them for such purposes in circuits with conventional residual current devices causes frequent problems with unwanted tripping.

The technical root cause of this phenomenon is the following: Fast switching operations involving high voltages cause high interference levels which propagate through the lines on the one hand, and in the form of interfering radiation on the other. In order to eliminate this problem, a mains-side filter (also referred to as input filter or EMC-filter) is connected between the RCD and frequency converter. The anti-interference capacitors in the filters produce discharge currents against earth which may cause unwanted tripping of the RCD due to the apparent residual currents. Connecting a filter on the output side between frequency converter and 3-phase AC motor results in the same behaviour.

This sample tripping characteristic of a 100 mA RCD and a 300 mA RCD shows the following: In the frequency range around 50 Hz, the RCDs trip as required (50 - 100 % of the indicated  $I_{\Delta n}$ ). In the range shown hatched in the diagram, i. e. from approx. 100 to 300 Hz, unwanted tripping occurs frequently due to the use of frequency converters. Frequency converter-proof residual current devices are much less sensitive in this frequency range than in the 50 - 60 Hz range, which leads to an enormous increase in the reliability of systems.

**Therefore, we recommend to use RCDs designed for applications with frequency converter!**

These special residual current devices can be recognised by an extension of the type designation („-F“). They meet the requirements of compatibility between RCDs and frequency converters with respect to unwanted tripping.

These are **NOT AC/DC-sensitive** (IEC 62423) RCDs of type B !!!

Our RCDs of type „-F“ are characterised by **SENSITIVITY TO RESIDUAL PULSATING DC** and **SELECTIVITY** or **SHORT-TIME DELAY**



wa\_sg08020\_1



## Description

- Line voltage independent RCCB for fault or additional protection with additional digital features
- System Monitoring: Preventive information / warning before the RCD trips in case of leakage currents
  - Integrated auxiliary contact
  - Local Indication
- New level of accuracy -> reduced unwanted tripping
- Yearly test interval
- Comprehensive range of accessories
- Real contact position indicator
- Fault current tripping indicator
- Automatic re-setting possible
- Transparent designation plate
- Classified for the use in rail rolling stock

$I_n/I_{\Delta n}$ (A)	Type Designation	Article No.	Units per package
---------------------------	---------------------	-------------	----------------------

#### Type G/A

**Surge current-proof 3 kA, sensitive to residual pulsating DC, Type G/A (ÖVE E 8601)** 

wa\_sg08020\_1



##### 4-poles

25/0.03	FRCdM-25/4/003-G/A	168646	1/30
25/0.3	FRCdM-25/4/03-G/A	168647	1/30
40/0.03	FRCdM-40/4/003-G/A	168648	1/30
40/0.3	FRCdM-40/4/03-G/A	168649	1/30
63/0.03	FRCdM-63/4/003-G/A	168650	1/30
63/0.3	FRCdM-63/4/03-G/A	168651	1/30
80/0.03	FRCdM-80/4/003-G/A	168634	1/30
80/0.3	FRCdM-80/4/03-G/A	168635	1/30

#### Type R

**Surge current-proof 3 kA, X-ray application, Type R** 

wa\_sg06820\_1



##### 4-poles

63/0.03	FRCdM-63/4/003-R	168636	1/30
---------	------------------	--------	------

#### Type S/A

**Selective + surge current-proof typ. 5 kA, sensitive to residual pulsating DC, Type S/A** 

wa\_sg07020\_1



##### 4-poles

40/0.3	FRCdM-40/4/03-S/A	168637	1/30
63/0.3	FRCdM-63/4/03-S/A	168638	1/30
80/0.3	FRCdM-80/4/03-S/A	168639	1/30

#### Type U

**Short-time delayed + surge current-proof 3 kA, Type U** 

wa\_sg07620\_1



##### 4-poles

40/0.03	FRCdM-40/4/003-U	168643	1/30
63/0.03	FRCdM-63/4/003-U	168640	1/30

$I_n/I_{\Delta n}$ (A)	Type Designation	Article No.	Units per package
---------------------------	---------------------	-------------	----------------------

**Type U**

**Selective + surge current-proof typ. 5 kA, frequency converter-proof, Type U** 

**4-poles**

40/0.3	FRCdM-40/4/03-U	168644	1/30
63/0.3	FRCdM-63/4/03-U	168641	1/30
80/0.3	FRCdM-80/4/03-U	168642	1/30

wa\_sg07720\_1





## Specifications | Residual Current Devices FRCDM

### Description





- Residual current devices
- Shape compatible with and suitable for standard busbar connection to other devices of the xEffect-series
- Twin-purpose terminal (lift/open-mouthed) above and below
- Busbar positioning optionally above or below
- Free terminal space despite installed busbar
- Universal tripping signal switch, also suitable for FAZ, FRBmM-1N can be mounted subsequently
- Auxiliary switch Z-HK can be mounted subsequently
- Contact position indicator red - green
- Tripping indicator white - blue
- Additional Safety
  - possibility to seal
  - possibility to lock in ON and OFF position
- Delayed types suitable for being used with standard fluorescent tubes with or without electronical ballast (30mA-RCD: 30 units per phase conductor, 100mA-RCD: 90 units per phase conductor).
 

Notes: Depending of the fluorescent lamp ballast manufacturer partly more possible. Symmetrical allocation of the fluorescent lamp ballasts on all phases favourably. Shifting references of the fluorescent lamp ballast manufacturer consider.
- The device functions irrespective of the position of installation
- Tripping is line voltage-independent. Consequently, the RCD is suitable for "fault protection" and "additional protection" within the meaning of the applicable installation rules.
- Mains connection at either side (except applications according to connection diagramm ②)
- The 4-pole device can also be used for 3-pole connection:  
See connection possibilities.
- The 4-pole device can also be used for 2-pole connection:  
See connection possibilities.
- The test key "T" must be pressed every year. The system operator must be informed of this obligation and his responsibility in a way that can be proven. Under special conditions (e.g. damply and/or dusty environments, environments with polluting and/or corroding conditions, environments with large temperature fluctuations, installations with a risk of overvoltages due to switching of equipment and/or atmospheric discharges, portable equipment ...), it's recommended to test in monthly intervals. A test is further needed if red and yellow LED are on together.
- Pressing the test key "T" serves the only purpose of function testing the residual current device (RCD). This test does not make earthing resistance measurement ( $R_E$ ), or proper checking of the earth conductor condition redundant, which must be performed separately.
- **Functioning**
  - The green LED becomes active at 0-30%  $I_{\Delta n}$
  - The yellow LED becomes active at 30-50%  $I_{\Delta n}$
  - The red LED becomes active at >50%  $I_{\Delta n}$
  - Tolerance:  $\pm 5\%$
- Potential-free auxiliary contact (NO contact, in parallel with the yellow LED, up to 0.25 A ohmic load / 240 V~) for external prewarning function. The potential-free auxiliary contact stay ON also when the breaker trips. After switching the breaker ON again, the contact will be reseted. The potential-free auxiliary contact (13, 14) provides only basic insulation from terminals 2, 4, 6, N of the RCCB. Without any additional protective measures (isolation transformer 1:1 according to IEC/EN 60664) the potential-free auxiliary contact (13, 14) may only be supplied from the terminals 2, 4, 6, N. See also connection diagrams ②, ③.
- **Type -A:** Protects against special forms of residual pulsating DC which have not been smoothed.
- **Type -G:** High reliability against unwanted tripping. Suitable for any circuit where personal injury or damage to property may occur in case of unwanted tripping.
- **Type -G/A:** Additionally protects against special forms of residual pulsating DC which have not been smoothed.
- **Type -R:** To avoid unwanted tripping due to X-ray devices.
- **Type -S:** Selective residual current device sensitive to AC, Type -S. Suitable for systems with surge arresters downstream of the RCD.
- **Type -S/A:** Additionally protects against special forms of residual pulsating DC which have not been smoothed.
- **Type -U:** Suitable for speed-controlled drives with frequency converters in household, trade, and industry. Unwanted tripping is avoided thanks to a tripping characteristic designed particularly for frequency converters.

**Local Indication RCCB**

**Statusanzeige LED**

**red / yellow / green**

Permanent light green		Normal operation
Permanent light yellow		The measured residual current is higher than 30% of the nominal tripping value.
Permanent light red		The measured residual current is higher than 50% of the nominal tripping value.
Flashing yellow/red		Check the device with test key. If the LEDs are still flashing check the direction of connection (supply side / load side).

**Remote Indication**

Potential-free auxiliary contact for use in control circuits. The potential-free auxiliary contact (13, 14) provides only basic insulation from terminals 2, 4, 6, N of the RCCB. Without any additional protective measures (isolation transformer 1:1 according to IEC/EN 60664) the potential-free auxiliary contact (13, 14) may only be supplied from the terminals 2, 4, 6, N. See also connection diagrams. 0.25A ohmic load / 240V AC.

**Accessories:**

Auxiliary switch for subsequent installation to the left	Z-HK	248432
Tripping signal contact for subsequent installation to the right	Z-NHK	248434
Automatic restarting device	Z-FW/LP	248296
	Z-FW-LPD	265244
Remote control	Z-FW-MO	284730
Pre-mounted sets	Z-FW-LP/MO	290171
	Z-FW-LPD/MO	290172
Remote testing module	Z-FW/003	248298
	Z-FW/010	248299
	Z-FW/030	248300
Terminal cover 4-poles	Z-RC/AK-4TE	101062

## Technical Data

		FRCdM
<b>Electrical</b>		
Design according to		IEC/EN 61008 Type G and G/A acc. to ÖVE E 8601 IEC 61373, EN 45545-2
Classified according to		
Current test marks as printed onto the device		
Tripping		instantaneous
Type G , R		10 ms delay
Type S		40 ms delay - with selective disconnecting function
Type U (only 30 mA)		10 ms delay
Type U (except 30 mA)		40 ms delay - with selective disconnecting function
Rated voltage	$U_n$	240/415 V AC, 50Hz
Limits operation voltage electronic		50 – 264V AC
Limits operation voltage test circuit 30, 300 mA		196 – 264V AC
Rated tripping current	$I_{\Delta n}$	30, 300 mA
Sensitivity		AC and pulsating DC
Rated insulation voltage	$U_i$	440 V
Rated impulse withstand voltage	$U_{imp}$	4 kV (1.2/50µs)
Rated short circuit capacity	$I_{cn}$	10 kA with back-up fuse
Peak withstand current		
Type G, G/A, R, U (30 mA)		3 kA (8/20 µs) surge current-proof
Type S/A, U (except 30 mA)		typ. 5 kA (8/20 µs) selective + surge current-proof
Rated breaking capacity	$I_m$	
or rated fault breaking capacity	$I_{\Delta m}$	
$I_n = 25-40$ A		500 A
$I_n = 63$ A		630 A
$I_n = 80$ A		800 A
Endurance		
electrical components		≥ 4,000 operating cycles
mechanical components		≥ 20,000 operating cycles
<b>Mechanical</b>		
Frame size		45 mm
Device height		80 mm
Device width		70 mm (4MU)
Mounting		quick fastening with 2 lock-in positions on DIN rail IEC/EN 60715
Degree of protection, built-in		IP40
Degree of protection in moisture-proof enclosure		IP54
Upper and lower terminals		open mouthed/lift terminals
Terminal protection		finger and hand touch safe, DGUV VS3, EN 50274
Terminal capacity		1.5 - 35 mm <sup>2</sup> single wire 2 x 16 mm <sup>2</sup> multi wire
Terminal screw		M5 (with slotted screw acc. to EN ISO 4757-Z2, Pozidriv PZ2)
Terminal torque		2 - 2.4 Nm
Busbar thickness		0.8 - 2 mm
Operation temperature		-25°C to +40°C (for higher values see table on ambient temperature)
Storage- and transport temperature		-35°C to +60°C
Resistance to climatic conditions		acc. to IEC/EN 61008
Contact position indicator		red / green
Tripping indicator		white / blue
<b>Alarm contact (potential-free)</b>		
Rated breaking capacity @ 30 V DC (resistive load)		2 A
Rated breaking capacity @ 240 V AC (resistive load)		0.25 A
Maximum switching power (resistive load)		60 W
Maximum switching voltage DC		220 V
Maximum switching voltage AC		240 V
Maximum switching current		2 A
Minimum switching capacity (reference value)		10 µA, 10 mV DC
Endurance		
Electrical (at 20 cpm) 2 A 30 V DC resistive load)		>10 <sup>5</sup>
Electrical (at 20 cpm) 1 A 30 V DC resistive load)		>5 x 10 <sup>5</sup>
Terminal capacity		0.25 - 1.5 mm <sup>2</sup>

Connection diagram

4-poles

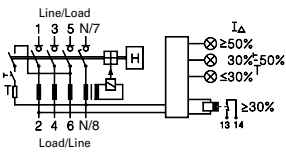

① Without use of auxiliary contact line/load side free selectable

4-poles

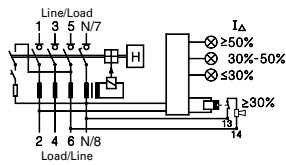

② Signalisation without Isolation Transformer 1:1 (IEC/EN 60664)

4-poles

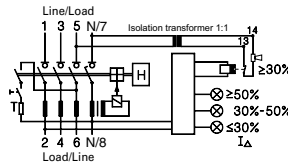

③ Signalisation with Isolation Transformer 1:1 (IEC/EN 60664)

Dimensions (mm)

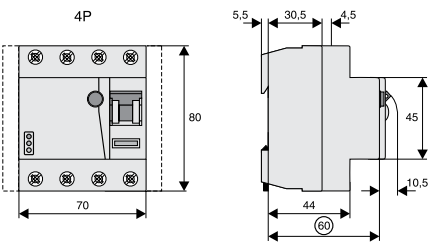

Correct connection

30, 300mA Types:

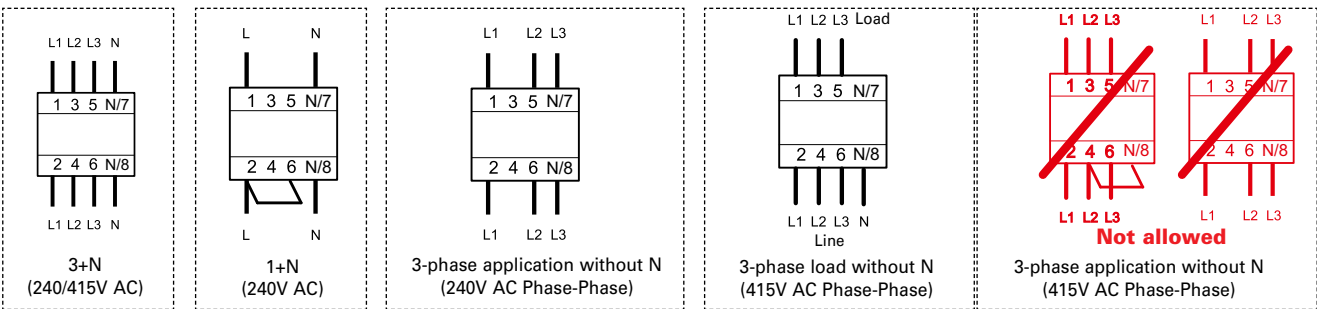

Electronic works within 50-264V AC!

- Disconnect load side of the switch gear, if you make a insulation test of the installation!

Internal Resistance FRCdM

At room temperature (single pole)

In [A]	Z* [mΩ]
25	0.66
40	0.64
63	0.64
80	0.62

\* 50Hz

Power Loss at In FRCdM

(entire unit)

In [A]	P* [W]
25	2.2
40	3.8
63	8.5
80	12.9

\* 50Hz

Impact of ambient temperature on the maximum permanent current allowed (A) FRCdM type A, U and R

Ambient temperature	25A	40A	63A	80A
	4p	4p	4p	4p
40°	25	40	63	80
45°	25	35	55	71
50°	25	30	47	63
55°	23	28	38	54
60°	20	25	30	45
65°	-	-	-	-
70°	-	-	-	-
75°	-	-	-	-

Note: Please make sure that these values are not exceeded and that any upstream thermal overload protection switches off in time.

**Max. back-up fuse FRCDM**

Rating In [A]	Fuses		MCB's (Characteristic B/C)	
	Short Circuit [A]	Overload [A]	Short Circuit [A]	Overload [A]
25	63 gG/gI	25 gG/gI	FAZ-C40	FAZ-C25
40	63 gG/gI	40 gG/gI	FAZ-C40	FAZ-C40
63	63 gG/gI	63 gG/gI	FAZ-C40	FAZ-C40
80	80 gG/gI	80 gG/gI	-	-

**Important:**

In the case that the maximal possible operating current of the electrical installation don't exceed the rated current of the RCD only short circuit protection must be implemented. Overload protection must be implemented in the case if the maximal possible operating current of the electrical installation can exceed the rated current of the RCD.

wa\_sg04320\_1





## Description

- All-current sensitive RCCB for fault or additional protection
- Digital Features to increase the system availability
- System Monitoring: Preventive information / warning before the RCD trips in case of leakage currents
  - Integrated auxiliary contact for remote pre-warning
  - Local Indication through 3 LEDs
- B+ types also meet the requirements of superior fire-protection systems according to VDE 0664-400 (formerly known as VDE V 0664-110)
- 4-pole types can also be used as 2-pole devices for photovoltaic applications
- New level of accuracy -> reduced unwanted tripping
- Yearly test interval
- Comprehensive range of accessories
- Real contact position indicator
- Fault current tripping indicator
- Automatic re-setting possible
- Transparent designation plate
- Classified for the use in rail rolling stock



$I_n/I_{\Delta n}$ (A)	Operating frequency (Hz)	Type Designation	Article No.	Units per package
---------------------------	-----------------------------	---------------------	-------------	----------------------

#### Type G/B

**Surge current-proof 3 kA, AC-DC sensitive, Type G/B (ÖVE E 8601)**   

wa\_sg10420\_1



##### 2-Pole (4MU)

25/0.03	50	FRCdM-25/2/003-G/B	300638	1/30
25/0.3	50/60	FRCdM-25/2/03-G/B	302638	1/30
40/0.03	50	FRCdM-40/2/003-G/B	300639	1/30
40/0.3	50/60	FRCdM-40/2/03-G/B	302639	1/30
63/0.03	50	FRCdM-63/2/003-G/B	300640	1/30
63/0.3	50/60	FRCdM-63/2/03-G/B	302640	1/30



wa\_sg05320\_1



##### 4-poles

25/0.03	50	FRCdM-25/4/003-G/B	167892	1/30
25/0.3	50/60	FRCdM-25/4/03-G/B	167896	1/30
40/0.03	50	FRCdM-40/4/003-G/B	167893	1/30
40/0.3	50/60	FRCdM-40/4/03-G/B	167897	1/30
63/0.03	50	FRCdM-63/4/003-G/B	167894	1/30
63/0.3	50/60	FRCdM-63/4/03-G/B	167898	1/30

#### Type S/B

**Selective + surge current-proof 5 kA, Type S/B**   

wa\_sg11620\_1



##### 2-Pole (4MU)

25/0.3	50	FRCdM-25/2/03-S/B	302635	1/30
40/0.3	50	FRCdM-40/2/03-S/B	302636	1/30
63/0.3	50	FRCdM-63/2/03-S/B	302637	1/30

wa\_sg05920\_1



##### 4-poles

25/0.3	50	FRCdM-25/4/03-S/B	167900	1/30
40/0.3	50	FRCdM-40/4/03-S/B	167901	1/30
63/0.3	50	FRCdM-63/4/03-S/B	167902	1/30

#### Type G/Bfq

**Surge current-proof 3 kA, AC-DC sensitive, Type G/Bfq (ÖVE E 8601)**   

wa\_sg09220\_1





##### 4-poles

25/0.03	50	FRCdM-25/4/003-G/Bfq	179530	1/30
25/0.03	50	FRCdM-25/4/003-G/Bfq-400	306415	1/30
25/0.3	50/60	FRCdM-25/4/03-G/Bfq	167904	1/30
40/0.03	50	FRCdM-40/4/003-G/Bfq	179531	1/30
40/0.03	50	FRCdM-40/4/003-G/Bfq-400	306418	1/30
40/0.3	50/60	FRCdM-40/4/03-G/Bfq	167905	1/30
63/0.03	50	FRCdM-63/4/003-G/Bfq	179532	1/30
63/0.03	50	FRCdM-63/4/003-G/Bfq-400	306421	1/30
63/0.3	50/60	FRCdM-63/4/03-G/Bfq	167906	1/30

$I_n/I_{\Delta n}$ (A)	Operating frequency (Hz)	Type Designation	Article No.	Units per package
---------------------------	-----------------------------	---------------------	-------------	----------------------

**Type S/Bfq**

**Selective + surge current-proof 5 kA, Type S/Bfq**   

**4-poles**

wa\_sg06520\_1



25/0.3	50	FRCdM-25/4/03-S/Bfq	167908	1/30
40/0.3	50	FRCdM-40/4/03-S/Bfq	167909	1/30
63/0.3	50	FRCdM-63/4/03-S/Bfq	167910	1/30

**Type G/B+**

**Surge current-proof 3 kA, Type G/B+ (ÖVE E 8601)**   kHz



**4-poles**

wa\_sg04420\_1



25/0.03	50	FRCdM-25/4/003-G/B+	167880	1/30
25/0.03	50	FRCdM-25/4/003-G/B+-400	306422	1/30
25/0.3	50/60	FRCdM-25/4/03-G/B+	167884	1/30
40/0.03	50	FRCdM-40/4/003-G/B+	167881	1/30
40/0.03	50	FRCdM-40/4/003-G/B+-400	306423	1/30
40/0.3	50/60	FRCdM-40/4/03-G/B+	167885	1/30
63/0.03	50	FRCdM-63/4/003-G/B+	167882	1/30
63/0.03	50	FRCdM-63/4/003-G/B+-400	306424	1/30
63/0.3	50/60	FRCdM-63/4/03-G/B+	167886	1/30

**Type S/B+**

**Selective + surge current-proof 5 kA, Type S/B+**   kHz

wa\_sg05020\_1





**4-poles**

25/0.3	50	FRCdM-25/4/03-S/B+	167888	1/30
40/0.3	50	FRCdM-40/4/03-S/B+	167889	1/30
63/0.3	50	FRCdM-63/4/03-S/B+	167890	1/30

$I_n/I_{\Delta n}$ (A)	Operating frequency (Hz)	Type Designation	Article No.	Units per package
---------------------------	-----------------------------	---------------------	-------------	----------------------

### Type G/B

Surge current-proof 3 kA, AC-DC sensitive, Type G/B (ÖVE E 8601)   

wa\_sg09720\_1



#### 4-poles

25/0.03	60	FRCdM-25/4/003-G/B/60Hz	180418	1/30
40/0.03	60	FRCdM-40/4/003-G/B/60Hz	180421	1/30
63/0.03	60	FRCdM-63/4/003-G/B/60Hz	180424	1/30

### Type G/Bfq

Surge current-proof 3 kA, AC-DC sensitive, Type G/Bfq (ÖVE E 8601)   

wa\_sg09920\_1



#### 4-poles

25/0.03	60	FRCdM-25/4/003-G/Bfq/60Hz	180420	1/30
40/0.03	60	FRCdM-40/4/003-G/Bfq/60Hz	180423	1/30
63/0.03	60	FRCdM-63/4/003-G/Bfq/60Hz	180426	1/30

### Type G/B+

Surge current-proof 3 kA, Type G/B+ (ÖVE E 8601)   kHz

wa\_sg04720\_1



#### 4-poles





25/0.03	60	FRCdM-25/4/003-G/B+/60Hz	180419	1/30
25/0.3	50/60	FRCdM-25/4/03-G/B+	167884	1/30
40/0.03	60	FRCdM-40/4/003-G/B+/60Hz	180422	1/30
40/0.3	50/60	FRCdM-40/4/03-G/B+	167885	1/30
63/0.03	60	FRCdM-63/4/003-G/B+/60Hz	180425	1/30
63/0.3	50/60	FRCdM-63/4/03-G/B+	167886	1/30

## Specifications | Residual Current Devices FRCDM - digital, Type B, Bfq and B+

### Description

- Residual current devices, all-current sensitive
- Shape compatible with and suitable for standard busbar connection to other devices of the xEffect- and xPole-series
- Twin-purpose terminal (lift/open-mouthed) above and below
- Busbar positioning optionally above or below
- Free terminal space despite installed busbar
- Universal tripping signal switch, also suitable for FAZ, FRBmM-1N can be mounted subsequently
- Auxiliary switch Z-HK can be mounted subsequently
- Contact position indicator red - green
- Tripping indicator white - blue
- Additional Safety
  - possibility to seal
  - possibility to lock in ON and OFF position
- Delayed types (G, S) suitable for being used with standard fluorescent tubes with or without electronical ballast (30mA-RCD: 30 units per phase conductor).  
Notes: Depending of the fluorescent lamp ballast manufacturer partly more possible. Symmetrical allocation of the fluorescent lamp ballasts on all phases favourably. Shifting references of the fluorescent lamp ballast manufacturer consider.
- The device functions irrespective of the position of installation
- The RCD is suitable for "fault protection" and "additional protection" within the meaning of the applicable installation rules.
- The 4-pole device can also be used for 2- or 3-pole connection:  
See connection possibilities.
- The test key "T" must be pressed every year. The system operator must be informed of this obligation and his responsibility in a way that can be proven. Under special conditions (e.g. damply and/or dusty environments, environments with polluting and/or corroding conditions, environments with large temperature fluctuations, installations with a risk of overvoltages due to switching of equipment and/or atmospheric discharges, portable equipment ...), it's recommended to test in monthly intervals. A test is further needed if red and yellow LED are flashing alternately.
- Pressing the test key "T" serves the only purpose of function testing the residual current device (RCD). This test does not make earthing resistance measurement ( $R_E$ ), or proper checking of the earth conductor condition redundant, which must be performed separately.
- **Functioning**
  - The green LED becomes active at 0-30%  $I_{\Delta n}$
  - The yellow LED becomes active at 30-50%  $I_{\Delta n}$
  - The red LED becomes active at >50%  $I_{\Delta n}$
  - Tolerance:  $\pm 5\%$
- Potential-free auxiliary contact for use in control circuits, insulated from main circuit of the switch gear according to IEC/EN60664 (0.25A ohmic load / 240V AC) in parallel with the yellow LED, for external prewarning function. The potential-free auxiliary contact stays ON also when the breaker trips. After switching the breaker ON again the contact will be reseted. The potential-free contact (13, 14) provides only basic insulation from load side terminals of the RCCB. Without any additional protective measures (isolation transformer 1:1 according to IEC/EN 60664) the potential-free auxiliary contact (13, 14) may only be supplied from the load side terminals. See also connection diagrams.
- **Type -G/B and G/B+:** High reliability against unwanted tripping. Suitable for any circuit where personal injury or damage to property may occur in case of unwanted tripping. Protection against all types of fault currents.
- **Type -S/B and S/B+:** Selective residual current device. Protection against all types of fault currents.
- **Type -S/Bfq:** Suitable for speed-controlled drives with frequency converters inhousehold, trade, and industry. Unwanted tripping is avoided thanks to a tripping characteristic designed particularly for frequency converters. Protection against all types of fault currents.

**Local Indication RCCB**

Statusanzeige LED		red / yellow / green
Permanent light green		Normal operation
Permanent light yellow		The measured residual current is higher than 30% of the nominal tripping value.
Permanent light red		The measured residual current is higher than 50% of the nominal tripping value.
Flashing yellow/red		Check the device with test key. If the LEDs are still flashing check the direction of connection (supply side / load side).

**Remote Indication**

Potential-free auxiliary contact for use in control circuits. The potential-free auxiliary contact (13, 14) provides only basic insulation from load side terminals (2, 4, 6, N) of the RCCB. Without any additional protective measures (isolation transformer 1:1 according to IEC/EN 60664) the potential-free auxiliary contact (13, 14) may only be supplied from the load side terminals (2, 4, 6, N). See also connection diagrams ②, ③. 0.25A ohmic load / 240V AC.

**Accessories:**

Auxiliary switch for subsequent installation to the left	Z-HK	248432
Tripping signal contact for subsequent installation to the right	Z-NHK	248434
Automatic restarting device	Z-FW/LP	248296
	Z-FW-LPD	265244
Remote control	Z-FW-MO	284730
Pre-mounted sets	Z-FW-LP/MO	290171
	Z-FW-LPD/MO	290172
Remote testing module	Z-FW/001	248297
	Z-FW/003	248298
	Z-FW/010	248299
	Z-FW/030	248300
	Z-FW/050	248301
Terminal cover 4-poles	Z-RC/AK-4TE	101062

**Technical Data**

		FRCdM Type B, Bfq and B+
<b>Electrical</b>		
Design according to		Types B and Bfq acc. to IEC/EN 61008, IEC/EN 62423 Types B+ acc. to VDE 0664-400, formerly known as VDE V 0664-110 Type G/B, G/Bfq and G/B+ additional acc. to ÖVE E 8601 IEC 61373, EN 45545-2
Classified according to		
Current test marks as printed onto the device		
Tripping		
Type G		10 ms delay @ 50 Hz
Type S		40 ms delay @ 50 Hz - with selective disconnecting function
Rated voltage	$U_n$	240/415 V AC 50 Hz and/or 60 Hz – see individual article for operating frequency
Limits operation voltage electronic		50 – 456V AC
Limits operation voltage test circuit		
30 mA		196 - 264V AC
30 mA -400		353 - 456V AC
300 mA		196 - 456V AC
Rated tripping current	$I_{\Delta n}$	30, 300 mA
Sensitivity		All types of current
Rated insulation voltage	$U_i$	440 V
Rated impulse withstand voltage	$U_{imp}$	4 kV (1.2/50µs)
Rated short circuit capacity	$I_{cn}$	10 kA with back-up fuse
Peak withstand current		
Type G/B, G/B+ and G/Bfq		3 kA (8/20 µs) surge current-proof
Type S/B, S/B+ and S/Bfq		typ. 5 kA (8/20 µs) selective + surge current-proof
Rated breaking capacity or rated fault breaking capacity	$I_m$ $I_{\Delta m}$	
$I_n = 25-40$ A		500 A
$I_n = 63$ A		630 A
Endurance		
electrical components		≥ 4,000 operating cycles
mechanical components		≥ 20,000 operating cycles
<b>Mechanical</b>		
Frame size		45 mm
Device height		80 mm
Device width		70 mm (4MU)
Mounting		quick fastening with 2 lock-in positions on DIN rail IEC/EN 60715
Degree of protection, built-in		IP40
Degree of protection in moisture-proof enclosure		IP54
Upper and lower terminals		open mouthed/lift terminals
Terminal protection		finger and hand touch safe, DGUV VS3, EN 50274
Terminal capacity		1.5 - 35 mm <sup>2</sup> single wire 2 x 16 mm <sup>2</sup> multi wire
Terminal screw		M5 (with slotted screw acc. to EN ISO 4757-Z2, Pozidriv PZ2)
Terminal torque		2 - 2.4 Nm
Busbar thickness		0.8 - 2 mm
Operation temperature		-25°C to +40°C (for higher values see table on ambient temperature)
Storage- and transport temperature		-35°C to +60°C
Resistance to climatic conditions		25-55°C/90-95% relative humidity acc. to IEC 60068-2
Contact position indicator		red / green
Tripping indicator		white / blue
<b>Alarm contact (potential-free)</b>		
Rated breaking capacity @ 30 V DC (resistive load)		2 A
Rated breaking capacity @ 240 V AC (resistive load)		0.25 A
Maximum switching power (resistive load)		60 W
Maximum switching voltage DC		220 V
Maximum switching voltage AC		240 V
Maximum switching current		2 A
Minimum switching capacity (reference value)		10 µA, 10 mV DC
Endurance		
Electrical (at 20 cpm) 2 A 30 V DC resistive load)		>10 <sup>5</sup>
Electrical (at 20 cpm) 1 A 30 V DC resistive load)		>5 x 10 <sup>5</sup>
Terminal capacity		0.25 - 1.5 mm <sup>2</sup>



### Connection diagram

4-poles (2-Pole)

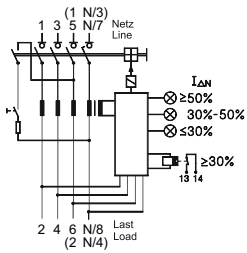

① Basic diagram

4-poles (2-Pole)

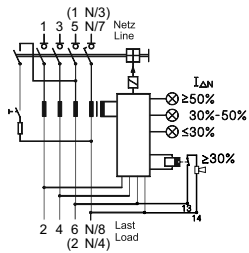

② Signalisation without Isolation  
Transformer 1:1 (IEC/EN 60664)

4-poles (2-Pole)

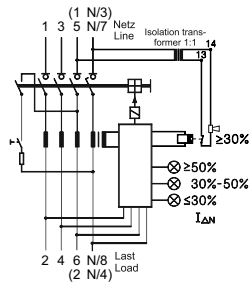

③ Signalisation with Isolation  
Transformer 1:1 (IEC/EN 60664)

### Dimensions (mm)

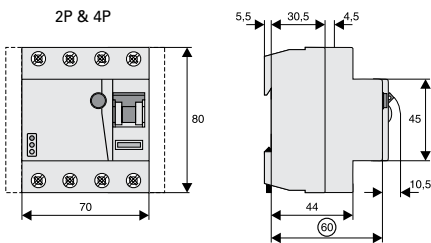

**Correct connection**

2-pole  
30, 300mA Types:

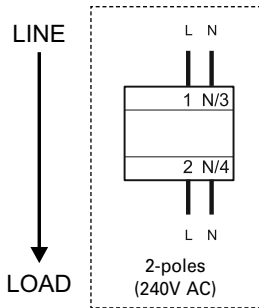

4-pole  
30mA -400 Types:

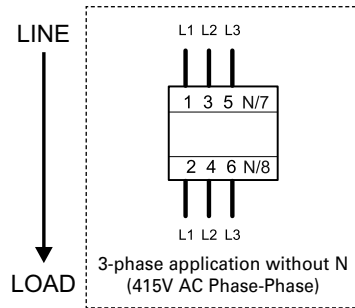

4-pole  
30mA Types:

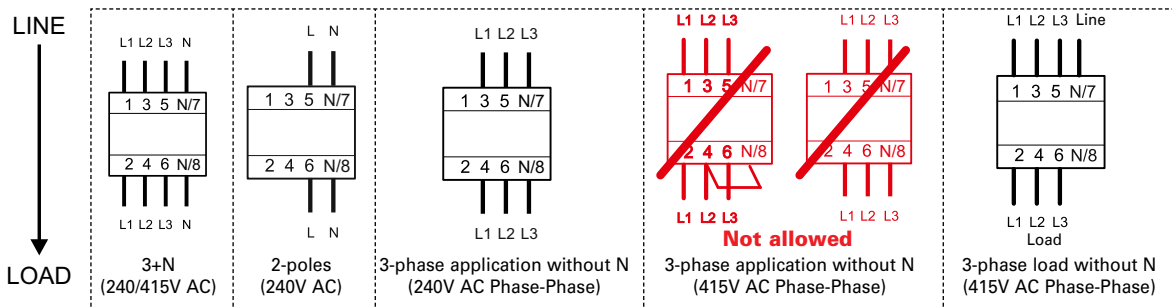

300mA Types:

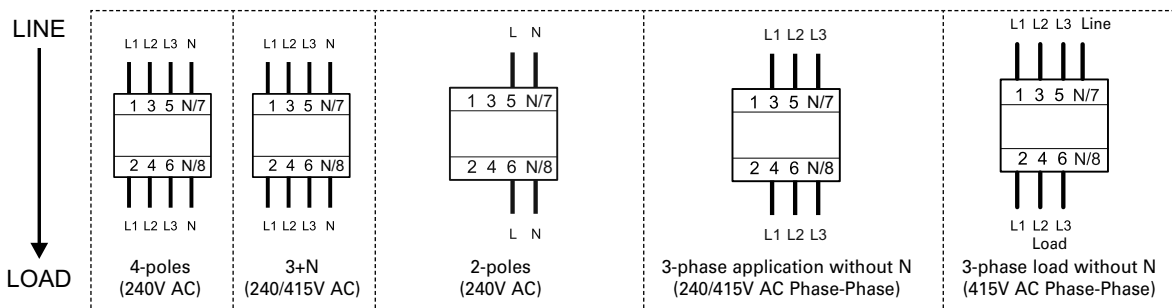

- Disconnect load side of the switch gear, if you make a insulation test of the installation!
- Please take care of supply side and load side!

#### Tripping current frequency response FRCdM Type B, Bfq and B+

**Type B 30mA**

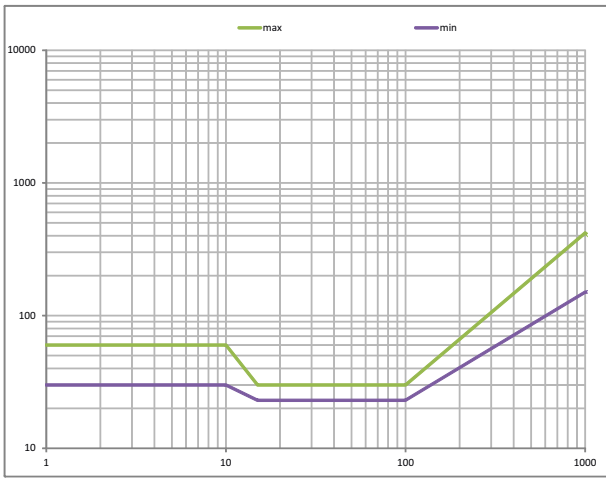

**Type B 300mA**

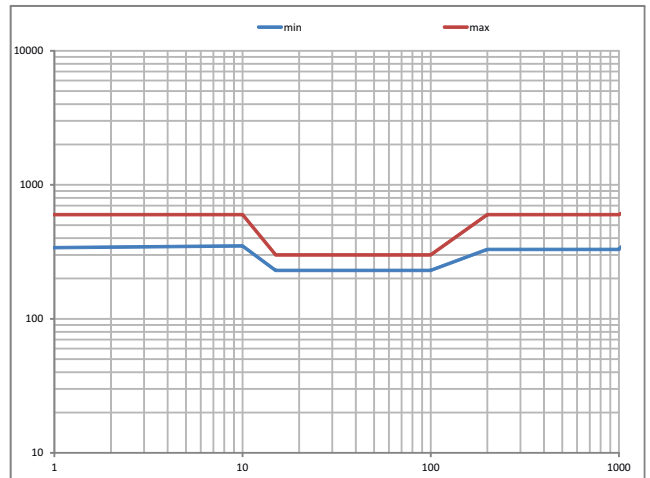

**Type B+ 30mA**

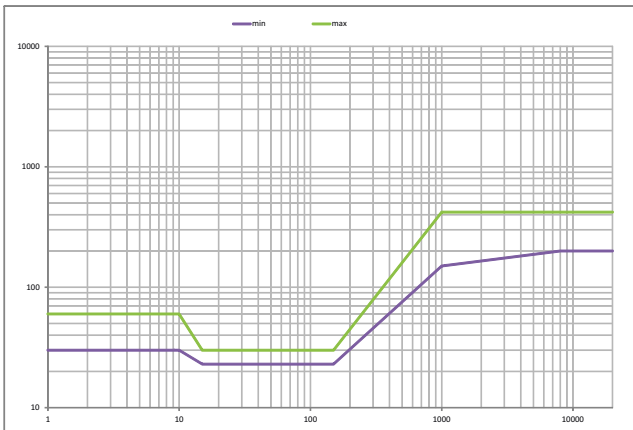

**Type B+ 300mA**

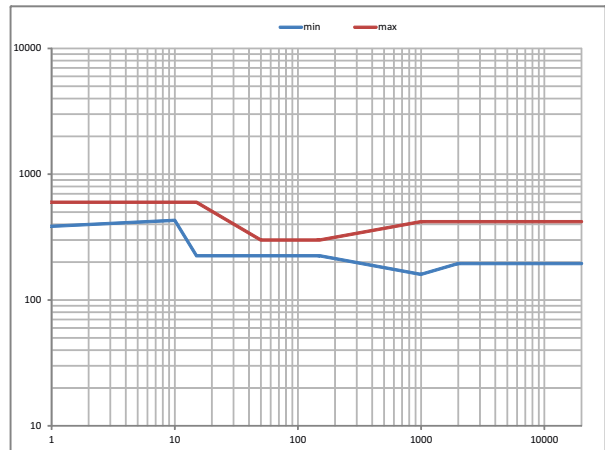

**Type Bfq 30mA**

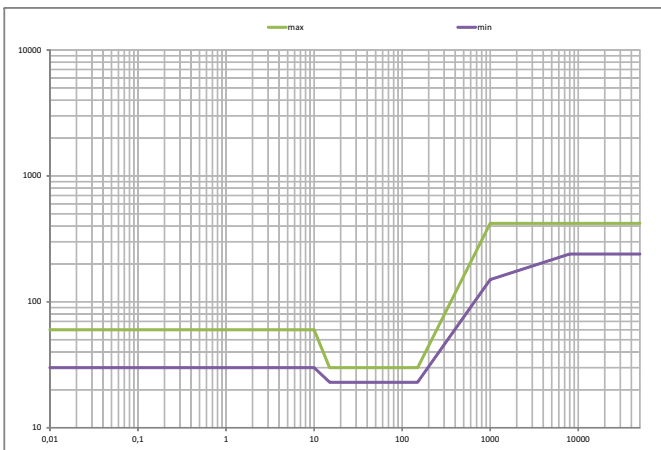

**Type Bfq 300mA**

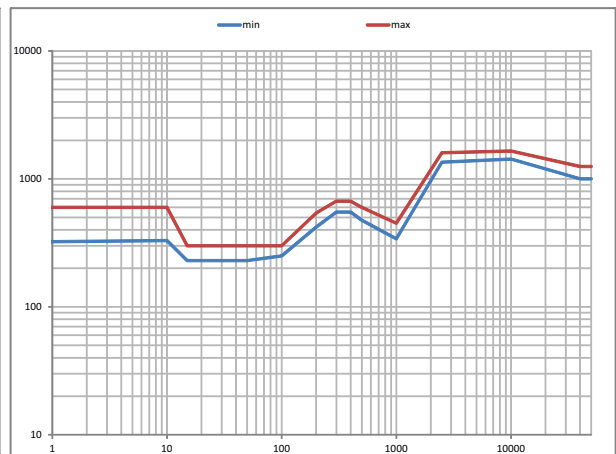

**Power Loss at  $I_n$  FRCdM**

(entire unit)

In [A]	P* [W]	
	2p	4p
25	3.1	4.6
40	4.1	6.2
63	6.7	10

\* 50Hz

**Impact of ambient temperature on the maximum permanent current allowed (A) FRCdM Type B, Bfq and B+**

Ambient temperature	25A	40A	63A
	2p & 4p	2p & 4p	2p & 4p
40°	25	40	63
45°	25	40	56
50°	25	40	50
55°	25	35	45
60°	25	30	40
65°	-	-	-
70°	-	-	-
75°	-	-	-

Note: Please make sure that these values are not exceeded and that any upstream thermal overload protection switches off in time.

**Max. back-up fuse FRCdM Type B**

Rating In [A]	Fuses		MCB's (Characteristic B/C)	
	Short Circuit [A]	Overload [A]	Short Circuit [A]	Overload [A]
25	63 gG/gI	25 gG/gI	FAZ-C40	FAZ-C25
40	63 gG/gI	40 gG/gI	FAZ-C40	FAZ-C40
63	63 gG/gI	63 gG/gI	FAZ-C40	FAZ-C40

Important:

In the case that the maximal possible operating current of the electrical installation don't exceed the rated current of the RCD only short circuit protection must be implemented. Overload protection must be implemented in the case if the maximal possible operating current of the electrical installation can exceed the rated current of the RCD.

Eaton's electrical business is a global leader with deep regional application expertise in power distribution and circuit protection; power quality, backup power and energy storage; control and automation; life safety and security; structural solutions; and harsh and hazardous environment solutions. Through end-to-end services, channel and an integrated digital platform & insights Eaton is powering what matters across industries and around the world, helping customers solve their most critical electrical power management challenges.

For more information, visit [Eaton.com](https://www.eaton.com).



**Eaton Industries (Austria) GmbH**  
Scheydgasse 42  
1210 Vienna  
Austria

**Eaton**  
EMEA Headquarters  
Route de la Longeraie 7  
1110 Morges, Switzerland

© 2021 Eaton  
All Rights Reserved  
Printed in Austria  
Publication No. CA001017EN  
Article number 302001-MK  
April 2021  
Graphics: SRA, Schrems

Changes to the products, to the information contained in this document, and to prices are reserved; as are errors and omissions. Only order confirmations and technical documentation by Eaton is binding. Photos and pictures also do not warrant a specific layout or functionality. Their use in whatever form is subject to prior approval by Eaton. The same applies to trademarks (especially Eaton, Moeller, and Cutler-Hammer). The Terms and Conditions of Eaton apply, as referenced on Eaton Internet pages and Eaton order confirmations.

Eaton is a registered trademark.

All other trademarks are property of their respective owners.

Follow us on social media to get the latest product and support information.

