

# Isolerstoffkapslinger type: MNX PCM PCM 100

130 x 80 x 60 mm (44,5 mm indre) klart lokk  
PCM 100/60 T - 2535500

## Tekniskinformasjon:

Slagfast polykarbonat.  
Med klare og grå lokk.  
Metriske nippelutslag.

IP 67, halogenfri, polykarbonat,  
-40°C – +120°C  
max. 80°C kontinuerlig

PCM.../...T = klart lokk  
PCM.../...G = grått lokk  
(begge m/50 mm underdel)



## Tilleggsutstyr:

Type EL.nr.

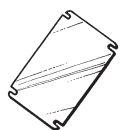

MIV 100

2536110

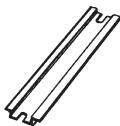

MIV 5

2536120

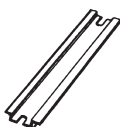

MIV 10

2536121

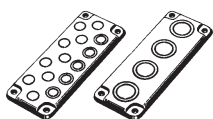

FPA 100/130

2535546

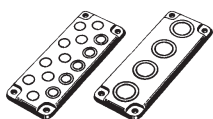

HFP 130

2535551

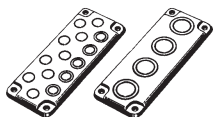

TH A

2535553

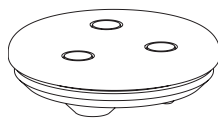

FP 22046

2535554



SS 14550L

2535555

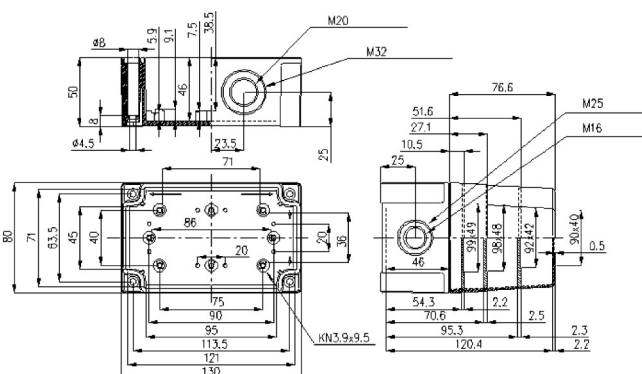

Egenskaper	Klassifisering
<ul style="list-style-type: none"> <li>- Tetthetsgrad</li> <li>- Totalisolert</li> <li>- Standard farge</li> <li>- Kapslingsmateriale</li> <li>Underdel</li> <li>Lokk</li> <li>Lokkskruer</li> <li>Pakning</li> </ul>	<p>IP-67 (IEC-529)</p> <p><input type="checkbox"/></p> <p>Lys grå (RAL-7035)</p> <p>Glassfiberarmert polykarbonat</p> <p>Polykarbonat</p> <p>Polyamid</p> <p>Polyuretan/EPDM</p>
<p><b>Polykarbonatets egenskaper:</b></p> <ul style="list-style-type: none"> <li>- Temperaturbestandighet: <ul style="list-style-type: none"> <li>- Max temperatur, kortvarig</li> <li>- Max temperatur, kontinuerlig</li> </ul> </li> <li>- Slagfasthet</li> <li>- Brennbarhet</li> <li>- Brannklasse</li> <li>- Avgasser</li> <li>- Kjemiske egenskaper</li> </ul>	<p>-40°C til +120°C</p> <p>-40°C til +80°C</p> <p>Meget høy (ved +23°C DIN 53453 ISO/R179 50 kJ/m<sup>2</sup> for underdel)</p> <p>Selvslukkende</p> <p>UL94-5V (UL 746 C 5)</p> <p>Halogenfri</p> <p>Meget god (be om egen oversikt)</p>