

Isolerstoffkapslinger type: EK EKM

Underdel: (HxBxD) 380x190x100
EKMB - 2536206

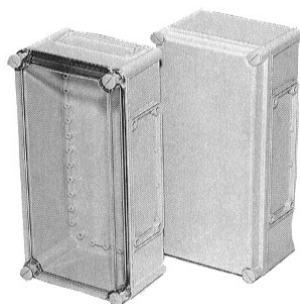

Tekniskinformasjon:

Slagfast polykarbonat med klare og grå lokk.

IP 67, halogenfri, polykarbonat,
-40°C - +120°C
max. 80°C kontinuerlig

Tilleggsutstyr:

Type

EL.nr.

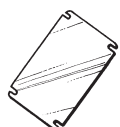

EKMVT

2536443

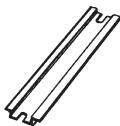

EKV 12

2536454

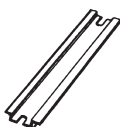

EKV 22

2536455



EKMZR

2536371



MB 10215

2536380



MB 10546

2536381

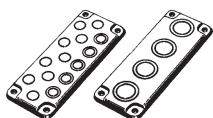

MB 10593

2536385

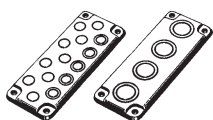

MB 10594

2536386

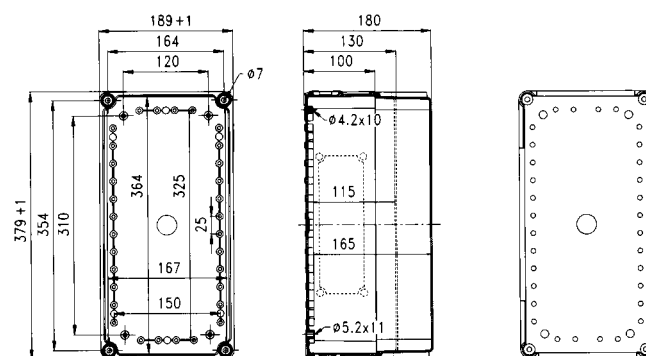

Egenskaper	Klassifisering
<ul style="list-style-type: none"> - Tetthetsgrad - Totalisolert - Standard farge - Kapslingsmateriale 	IP-67 (IEC 529) <input type="checkbox"/> Lys grå (RAL 7035)
Underdel Lokk Lokkskruer Pakning	Glassfiberarmert polykarbonat Polykarbonat Polyamid Polyuretan/EPDM
Polykarbonatets egenskaper: <ul style="list-style-type: none"> - Temperaturbestandighet: - Max temperatur, kortvarig - Max temperatur, kontinuerlig - Slagfasthet 	-40°C til +120°C Max +80°C Meget høy (ved +23°C DIN 53453 ISO/R179 50 kJ/m ² for underdel)
<ul style="list-style-type: none"> - Brennbarhet - Brannklasse - Avgasser - Kjemiske egenskaper 	Selvslukkende UL 94-5V Halogenfri Meget god (be om egen oversikt)