

**EU**  
**xComfort CIZE-02/01**

Assembly instructions  
Montageanweisung  
Instructions de montage  
Montážní návod  
Montážní návod  
Montagevejledning  
Instrucciones de montaje  
Szerezési utasítás  
Istruzioni di montaggio  
Montasje anvisning  
Montage instructie  
Instruções de montagem  
Instrukcja montażu  
Montageanvisning  
Asennusohjeet  
Montaj talimatı  
Instruțiuni de montaj  
Инструкция по монтажу  
οδηγία συναρμολόγησης  
安装说明书  
تعليمات التركيب



Danger  
Lebensgefahr  
Danger de mort  
Nebezpečí  
Nebezpečenstvo  
Fare  
Peligro  
Életveszély  
Pericolo di morte  
Fare  
Levensgevaar  
Perigo  
Niebezpieczeństwo  
Varning  
Vaara  
Hayati Tehlike  
Pericol  
Опасность  
κίνδυνος θανάτου  
危險  
خطر على الحياة



Installation by electricians only  
Montage nur durch Elektrofachkräfte  
Montage uniquement par un électricien  
Montáž pouze osobami s elektrotechnickou kvalifikací  
Montáž iba osobami s elektrotechnickou kvalifikáciou  
Må kun installeres af en aut. el-installatør  
Debe ser instalado por un profesional eléctrico  
Csak szakképzett személy szerelheti  
Montaggio esclusivamente ad opera di personale specializzato  
Må monteres av autorisert installatør Gr.L  
Montage alleen door elektromonteurs  
Deve ser instalado por um profissional  
Montaż tylko przez uprawnionych instalatorów  
Får endast utföras av behörig elektriker  
Asennus vain sähköasentajan toimesta  
Sadece uzman kişiler monte edebilir  
Instalare numai de către electricieni  
Монтаж может производить только электрик  
Εγκατάσταση μόνο από ηλεκτρολόγους  
仅允许合格电气技师进行安装  
التركيب فقط من قبل عمال كهرباء اختصاصيين



**CIZE-02/01**

**CMMZ-00/12**

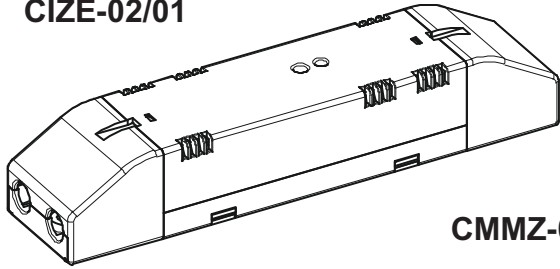

	Min. Version 1.46
	Min. Version 3.6B

**CMMZ-00/13**

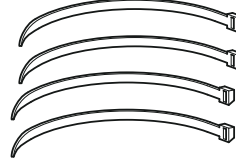

**IP20**

**868,3 MHz**

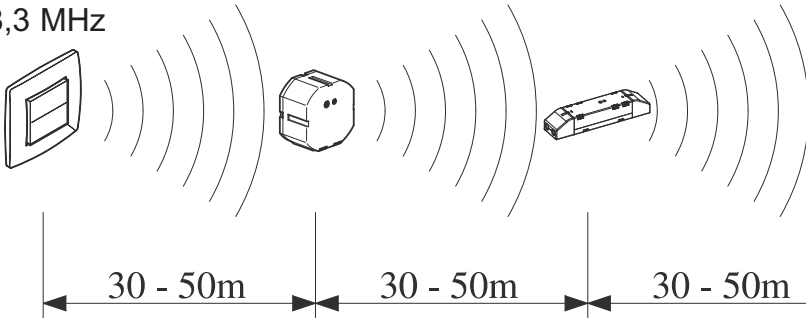

	T=-25°C - +70°C
	T=-5°C - +45°C

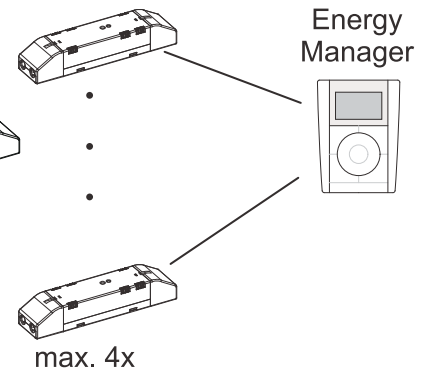
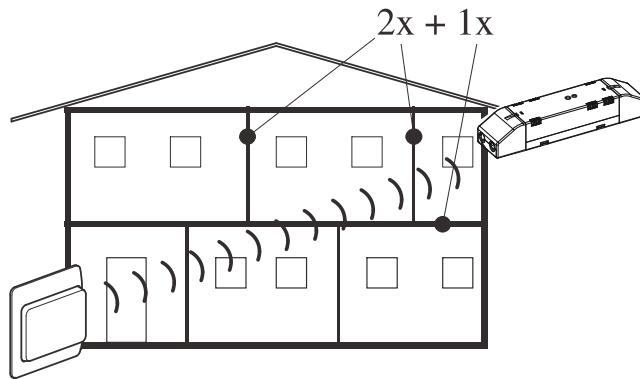
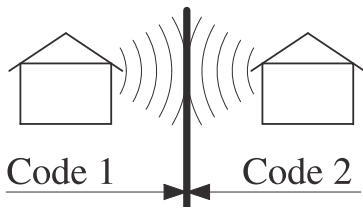

	~ 60-90%	~ 80-95%	~ 20-60%	~ 0-10%	~ 70-90%

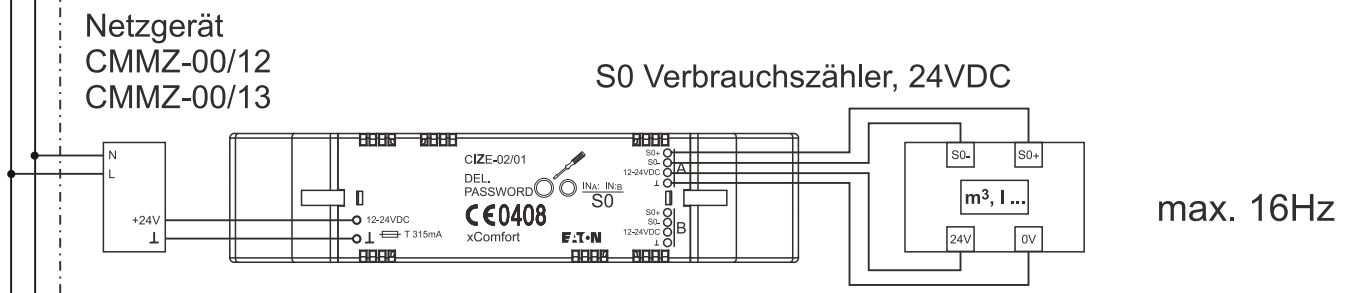
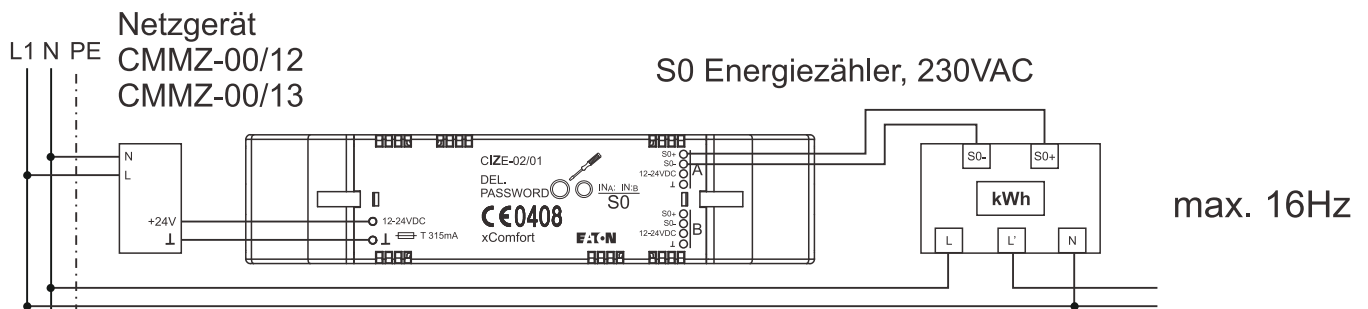
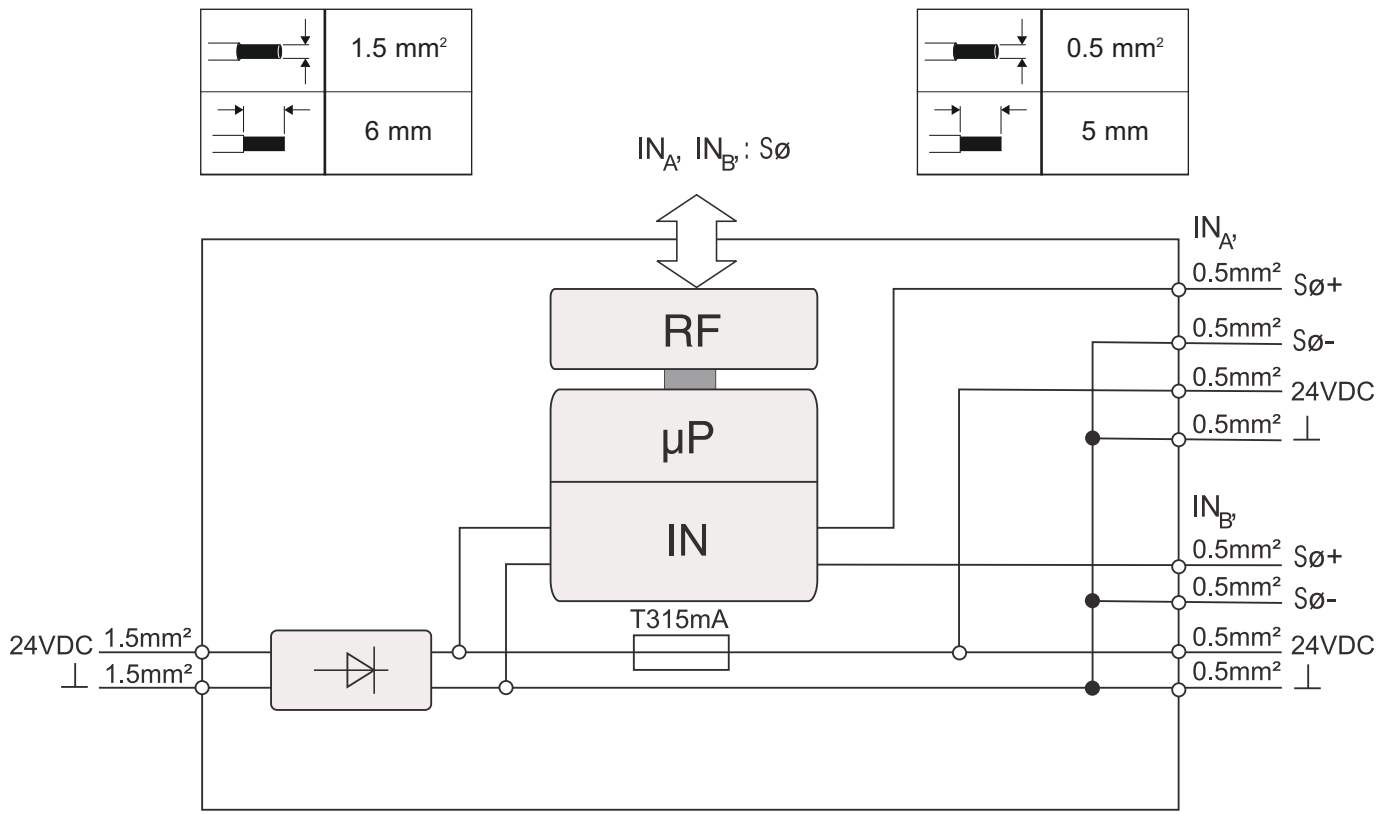



# Declaration of Conformity

We, EATON Industries (Austria) GmbH  
3943 Schrems, Eugenia 1  
Austria

declare that product (family)

## Eaton - Impulse Counter Input 2-fold,

### CIZE-...

(the declaration of conformity applies to all listed types within our actual product catalog)

provided that it is installed, maintained and used in the application intended for, with respect to the relevant manufacturers instructions, installation standards and "good engineering practices"

complies with the provisions of Council directive(s):

EMC Directive 2004/108/EC

Radio and Telecommunications Terminal Equipment 99/05/EC

RoHS Directive 2011/65/EU

based on compliance with European standard(s):

EN301489-3 V1.6.1, EN300220-2 V2.4.1, EN50491-5-1/10, EN50491-5-2/10, EN60950-1/06 + A11/09 + A11/10 + A12/11 + A2/13, EN62479/10



01.12.2014

tested by:  
TÜV Austria Services GmbH, Notified Body **CE 0408**  
1230 Vienna, Deutschstrasse 10, Austria

*Heinz Ursprunger*

Heinz Ursprunger  
Director Product Line  
& Marketing Management

*Friedrich Schröder*

Friedrich Schröder  
Director Quality  
& EHS

Affixing date of CE mark: 2008

Doc.Id.: CIZE-...

## RF- SYSTEM

### BASIC - MODE - CARD

	CTAA-01/01		CSAU-01/01		CTAA-02/01
	CBEU-02/01				CJAU-01/01
	CBEU-02/02		CDAU-01/01		CRCA-00/01
	M1 M2 M3 M4				CHSZ-00/01

