

EU
xComfort CKOZ-00/14

Assembly instructions
Montageanweisung
Instructions de montage
Montážní návod
Montážní návod
Montagevejledning
Instrucciones de montaje
Szerelési utasítás
Istruzioni di montaggio
Montasje anvisning
Montage instructie
Instruções de montagem
Instrukcja montazu
Montageanvisning
Asennusohjeet
Montaj talimatı
Instruțiuni de montaj
Инструкция по монтажу
οδηγία συναρμολόγησης
安装说明书
تعليمات التركيب



Danger
Lebensgefahr
Danger de mort
Nebezpečí
Nebezpečenstvo
Fare
Peligro
Életveszély
Pericolo di morte
Fare
Levensgevaar
Perigo
Niebezpieczeństwo
Varning
Vaara
Hayati Tehlike
Pericol
Опасность
κίνδυνος θανάτου
危險
خطر على الحياة



Installation by electricians only
Montage nur durch Elektrofachkräfte
Montage uniquement par un électricien
Montáž pouze osobami s elektrotechnickou kvalifikací
Montáž iba osobami s elektrotechnickou kvalifikáciou
Må kun installeres af en aut. el-installatør
Debe ser instalado por un profesional eléctrico
Csak szakképzett személy szerelheti
Montaggio esclusivamente ad opera di personale specializzato
Må monteres av autorisert installatør Gr.L
Montage alleen door elektromonteurs
Deve ser instalado por um profissional
Montaż tylko przez uprawnionych instalatorów
Får endast utföras av behörig elektriker
Asennus vain sähköasentajan toimesta
Sadece uzman kisiler monte edebilir
Instalare numai de catre electricieni
Монтаж может производить только электрик
Εγκατάσταση μόνο από ηλεκτρολόγους
仅允许合格电气技师进行安装
التركيب فقط من قبل عمال كهرباء اختصاصيين



CKOZ-00/14

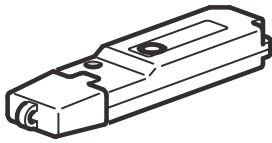

MRF
EATON Min. Version 2.11



	T=-25°C - +70°C
	T=-5°C - +45°C

IP20

868,3 MHz

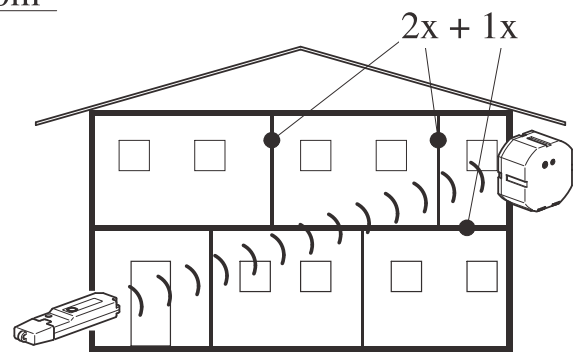
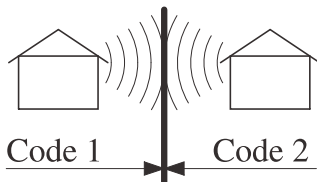
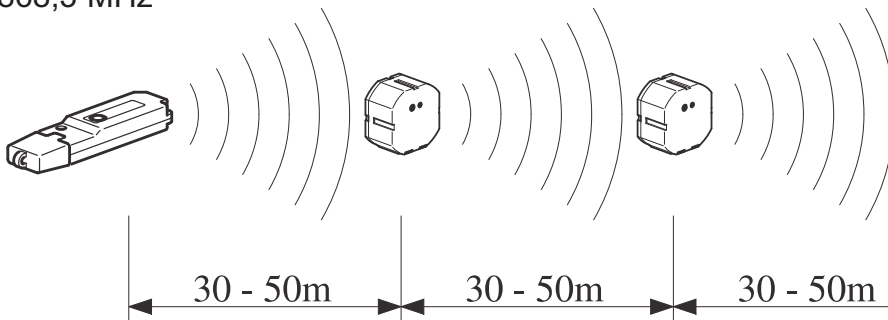

	~ 60-90%	~ 80-95%	~ 20-60%	~ 0-10%	~ 70-90%

1

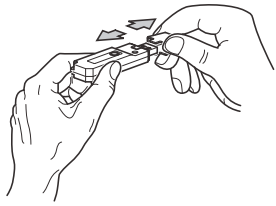

2



3

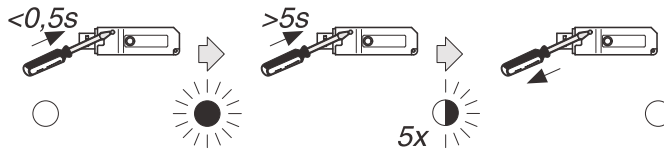
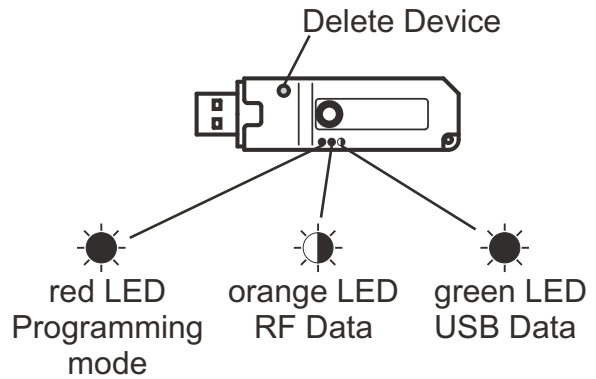

Declaration of Conformity

We, EATON Industries (Austria) GmbH
3943 Schrems, Eugenia 1
Austria

declare that product (family)

**Eaton - Communication Stick,
CKOZ-00/14**

(the declaration of conformity applies to all listed types within our actual product catalog)

provided that it is installed, maintained and used in the application intended for, with respect to the relevant manufacturers instructions, installation standards and "good engineering practices"

complies with the provisions of Council directive(s):

EMC Directive 2004/108/EC

Radio and Telecommunications Terminal Equipment 99/05/EC

RoHS Directive 2011/65/EU

based on compliance with European standard(s):

EN301489-3 V1.6.1, EN300220-2 V2.4.1, EN50491-5-1/10, EN50491-5-2/10, EN 62479/10, EN60950-1/06+A11/09+A11/10+A12/11+A2/13

01.12.2014

tested by:
TÜV Austria Services GmbH, Notified Body **CE0408**
1230 Vienna, Deutschstrasse 10, Austria

Heinz Ursprunger
Director Product Line
& Marketing Management

Friedrich Schröder
Director Quality
& EHS

Affixing date of CE mark: 2012
Doc.Id.: CKOZ-00/14