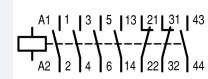
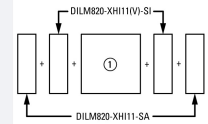

Contactor, I_{th} = I_e: 2450 A, RAW 250: 230 - 250 V 50 - 60 Hz/230 - 350 V DC, AC and DC operation, Screw connection

Part no. DILH2000/22(RAW250)
Catalog No. 272442
Alternate Catalog No. XTCEC20R22B
No.
EL-Nummer (Norway) 4130501

Delivery program

Product range			Contactors
Application			Mains contactors for resistive loads from 1000 A
Subrange			AC -1 contactors greater than 1000 A
Utilization category			AC-1: Non-inductive or slightly inductive loads, resistance furnaces
Connection technique			Screw connection
Rated operational current			
AC-1			
Conventional free air thermal current, 3 pole, 50 - 60 Hz			
Open			
at 40 °C	I _{th} = I _e	A	2450
Conventional free air thermal current, 1 pole			
open	I _{th}	A	5000
Contact sequence			
For use with			DILM820-XHI...
Actuating voltage			RAW 250: 230 - 250 V 50 - 60 Hz/230 - 350 V DC
Voltage AC/DC			AC and DC operation
Auxiliary contacts			
possible variants at auxiliary contact module fitting options			on the side: 2 x DILM820-XHI11(V)-SI; 2 x DILM820-XHI11-SA
Side mounting auxiliary contacts			
Instructions			Interlocked opposing contacts according to IEC/EN 60947-5-1 Appendix L, inside the auxiliary contact module Auxiliary contacts used as mirror contacts according to IEC/EN 60947-4-1 Appendix F (not N/C late open)
Instructions			integrated suppressor circuit in actuating electronics 660 V, 690 V or 1000 V: not directly reversing

Note concerning the product

Classic
 A1/A2 werden wie bisher gewohnt an Spannung gelegt

Direct from the PLC

An die Anschlüsse A3/A4 kann direkt ein 24-V-Ausgang der SPS angeschlossen werden.

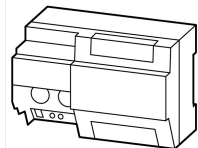

From a low-power actuating device

DILM1600, DILH2000, DILH2200

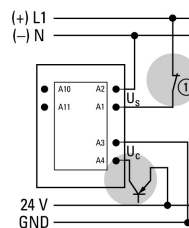
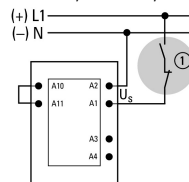

Gering belastbare Befehlsgeber wie Leiterplattenrelais, Befehlsgeräte oder Positionsschalter können direkt an A10/A11 angeschlossen werden.

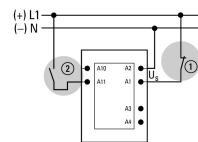
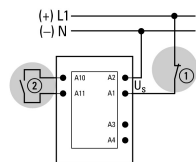

① Stopping in the event of an emergency (emergency switching off)

② max. Cable capacitance 6 nF

Technical data

General

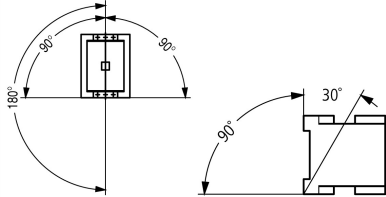
Standards			IEC/EN 60947, VDE 0660, UL, CSA, CCC
Lifespan, mechanical			
AC operated	Operations	$\times 10^6$	5
DC operated	Operations	$\times 10^6$	5
Operating frequency, mechanical			
AC operated	Operations/h		1000
DC operated	Operations/h		1000
Climatic proofing			Damp heat, constant, to IEC 60068-2-78 Damp heat, cyclic, to IEC 60068-2-30
Ambient temperature			
Open		°C	-40 - +60
Storage		°C	- 40 - + 80
Mounting position			
Mechanical shock resistance (IEC/EN 60068-2-27)			
Half-sinusoidal shock, 10 ms			
Main contacts			
N/O contact		g	10
Auxiliary contacts			
N/O contact		g	10
N/C contact		g	8
Degree of Protection			IP00
Altitude		m	Max. 2000
Weight		kg	32
Terminal capacity main cable			
Busbar	Width	mm	100
Main cable connection screw/bolt			M12
Tightening torque		Nm	35
Terminal capacity control circuit cables			
Solid		mm ²	1 x (0.75 - 2.5) 2 x (0.75 - 2.5)
Flexible with ferrule		mm ²	1 x (0.75 - 2.5) 2 x (0.75 - 2.5)
Solid or stranded		AWG	18 - 14
Stripping length		mm	10
Control circuit cable connection screw/bolt			M3.5
Tightening torque		Nm	1.2
Tool			
Main cable			
Width across flats		mm	18
Control circuit cables			
Pozidriv screwdriver		Size	2
Standard screwdriver		mm	0.8 x 5.5/1 x 6

Main conducting paths

Rated impulse withstand voltage	U_{imp}	V AC	8000
Overtoltage category/pollution degree			III/3
Rated insulation voltage	U_i	V AC	1000
Rated operational voltage	U_e	V AC	1000
Safe isolation to EN 61140			
between coil and contacts		V AC	500
between the contacts		V AC	500
Making capacity (p.f. to IEC/EN 60947)		A	9840
Breaking capacity			
220 V 230 V		A	8200
380 V 400 V		A	8200
500 V		A	8200
660 V 690 V		A	8200
1000 V		A	5800
Component lifespan			
			AC1: See → Engineering, characteristic curves

AC

AC-1			
Rated operational current			
Conventional free air thermal current, 3 pole, 50 - 60 Hz			
Open			
at 40 °C	$I_{th} = I_e$	A	2450
at 50 °C	$I_{th} = I_e$	A	2190
at 55 °C	$I_{th} = I_e$	A	2089
at 60 °C	$I_{th} = I_e$	A	2000
Conventional free air thermal current, 1 pole			
Note			at maximum permissible ambient air temperature
open	I_{th}	A	5000

Current heat loss

3 pole, at I_{th} (60°)		W	192
---------------------------	--	---	-----

Magnet systems

Voltage tolerance			
U_S			230 - 250 V 50/60 Hz 230 - 350 V DC
AC operated	Pick-up		$0.7 \times U_{S \min} - 1.15 \times U_{S \max}$
DC operated	Pick-up		$0.7 \times U_{S \min} - 1.15 \times U_{S \max}$
AC operated	Drop-out		$0.2 \times U_{S \max} - 0.6 \times U_{S \min}$
DC operated	Drop-out		$0.2 \times U_{S \max} - 0.6 \times U_{S \min}$
Power consumption of the coil in a cold state and $1.0 \times U_S$			
Note on power consumption			Control transformer with $u_k \leq 7\%$
Pull-in power	Pick-up	VA	1600
Pull-in power	Pick-up	W	1400
Sealing power	Sealing	VA	36.5
Sealing power	Sealing	W	17.3
Duty factor		% DF	100
Changeover time at 100 % U_S (recommended value)			
Main contacts			
Closing delay		ms	70
Opening delay		ms	40
Behaviour in marginal and transitional conditions			
Sealing			
Voltage interruptions			
($0 \dots 0.2 \times U_{c \min}$) ≤ 10 ms			Time is bridged successfully
($0 \dots 0.2 \times U_{c \min}$) > 10 ms			Drop-out of the contactor

Voltage drops			
(0.2 ... 0.6 x U _{C min}) ≤ 12 ms			Time is bridged successfully
(0.2 ... 0.6 x U _{C min}) > 12 ms			Drop-out of the contactor
(0.6 ... 0.7 x U _{C min})			Contactors remains switched on
Excess voltage			
(1.15 ... 1.3 x U _{C max})			Contactors remains switched on
Pick-up phase			
(0 ... 0.7 x U _{C min})			Contactors does not switch on
(0.7 x U _{C min} ... 1.15 x U _{C max})			Contactors switches on with certainty
Admissible transitional contact resistance (of the external control circuit device when actuating A11)	mΩ		≤ 500
PLC signal level (A3 - A4) to IEC/EN 61131-2 (type 2)			
High	V		15
Low	V		5

Electromagnetic compatibility (EMC)

Electromagnetic compatibility			This product is designed for operation in industrial environments (environment A). Its use in residential environments (environment B) may cause radio-frequency interference, requiring additional noise suppression measures.
-------------------------------	--	--	---

Rating data for approved types

Switching capacity			
General use		A	2000
Auxiliary contacts			
Pilot Duty			
AC operated			A600
DC operated			P300
General Use			
AC	V		600
AC	A		15
DC	V		250
DC	A		1
Special Purpose Ratings			
Resistance Air Heating			
480V 60Hz 3phase, 277V 60Hz 1phase		A	2000
600V 60Hz 3phase, 347V 60Hz 1phase		A	2000

Design verification as per IEC/EN 61439

Technical data for design verification			
Rated operational current for specified heat dissipation	I _n	A	2000
Heat dissipation per pole, current-dependent	P _{vid}	W	64
Equipment heat dissipation, current-dependent	P _{vid}	W	0
Static heat dissipation, non-current-dependent	P _{vs}	W	13
Heat dissipation capacity	P _{diss}	W	0
Operating ambient temperature min.		°C	-40
Operating ambient temperature max.		°C	60
IEC/EN 61439 design verification			
10.2 Strength of materials and parts			
10.2.2 Corrosion resistance			Meets the product standard's requirements.
10.2.3.1 Verification of thermal stability of enclosures			Meets the product standard's requirements.
10.2.3.2 Verification of resistance of insulating materials to normal heat			Meets the product standard's requirements.
10.2.3.3 Verification of resistance of insulating materials to abnormal heat and fire due to internal electric effects			Meets the product standard's requirements.
10.2.4 Resistance to ultra-violet (UV) radiation			Meets the product standard's requirements.
10.2.5 Lifting			Does not apply, since the entire switchgear needs to be evaluated.
10.2.6 Mechanical impact			Does not apply, since the entire switchgear needs to be evaluated.
10.2.7 Inscriptions			Meets the product standard's requirements.
10.3 Degree of protection of ASSEMBLIES			Does not apply, since the entire switchgear needs to be evaluated.

10.4 Clearances and creepage distances		Meets the product standard's requirements.
10.5 Protection against electric shock		Does not apply, since the entire switchgear needs to be evaluated.
10.6 Incorporation of switching devices and components		Does not apply, since the entire switchgear needs to be evaluated.
10.7 Internal electrical circuits and connections		Is the panel builder's responsibility.
10.8 Connections for external conductors		Is the panel builder's responsibility.
10.9 Insulation properties		
10.9.2 Power-frequency electric strength		Is the panel builder's responsibility.
10.9.3 Impulse withstand voltage		Is the panel builder's responsibility.
10.9.4 Testing of enclosures made of insulating material		Is the panel builder's responsibility.
10.10 Temperature rise		The panel builder is responsible for the temperature rise calculation. Eaton will provide heat dissipation data for the devices.
10.11 Short-circuit rating		Is the panel builder's responsibility. The specifications for the switchgear must be observed.
10.12 Electromagnetic compatibility		Is the panel builder's responsibility. The specifications for the switchgear must be observed.
10.13 Mechanical function		The device meets the requirements, provided the information in the instruction leaflet (IL) is observed.

Technical data ETIM 7.0

Low-voltage industrial components (EG000017) / Power contactor, AC switching (EC000066)		
Electric engineering, automation, process control engineering / Low-voltage switch technology / Contactor (LV) / Power contactor, AC switching (ecl@ss10.0.1-27-37-10-03 [AAB718015])		
Rated control supply voltage U_s at AC 50HZ	V	230 - 250
Rated control supply voltage U_s at AC 60HZ	V	230 - 250
Rated control supply voltage U_s at DC	V	230 - 250
Voltage type for actuating		AC/DC
Rated operation current I_e at AC-1, 400 V	A	2450
Rated operation current I_e at AC-3, 400 V	A	0
Rated operation power at AC-3, 400 V	kW	0
Rated operation current I_e at AC-4, 400 V	A	0
Rated operation power at AC-4, 400 V	kW	0
Rated operation power NEMA	kW	0
Modular version		No
Number of auxiliary contacts as normally open contact		2
Number of auxiliary contacts as normally closed contact		2
Type of electrical connection of main circuit		Rail connection
Number of normally closed contacts as main contact		0
Number of main contacts as normally open contact		3

Approvals

Product Standards		IEC/EN 60947-4-1; UL 60947-4-1; CSA - C22.2 No. 60947-4-1-14; CE marking
UL File No.		E29096
UL Category Control No.		NLDX
CSA File No.		012528
CSA Class No.		3211-04
North America Certification		UL listed, CSA certified
Specially designed for North America		No

Characteristics

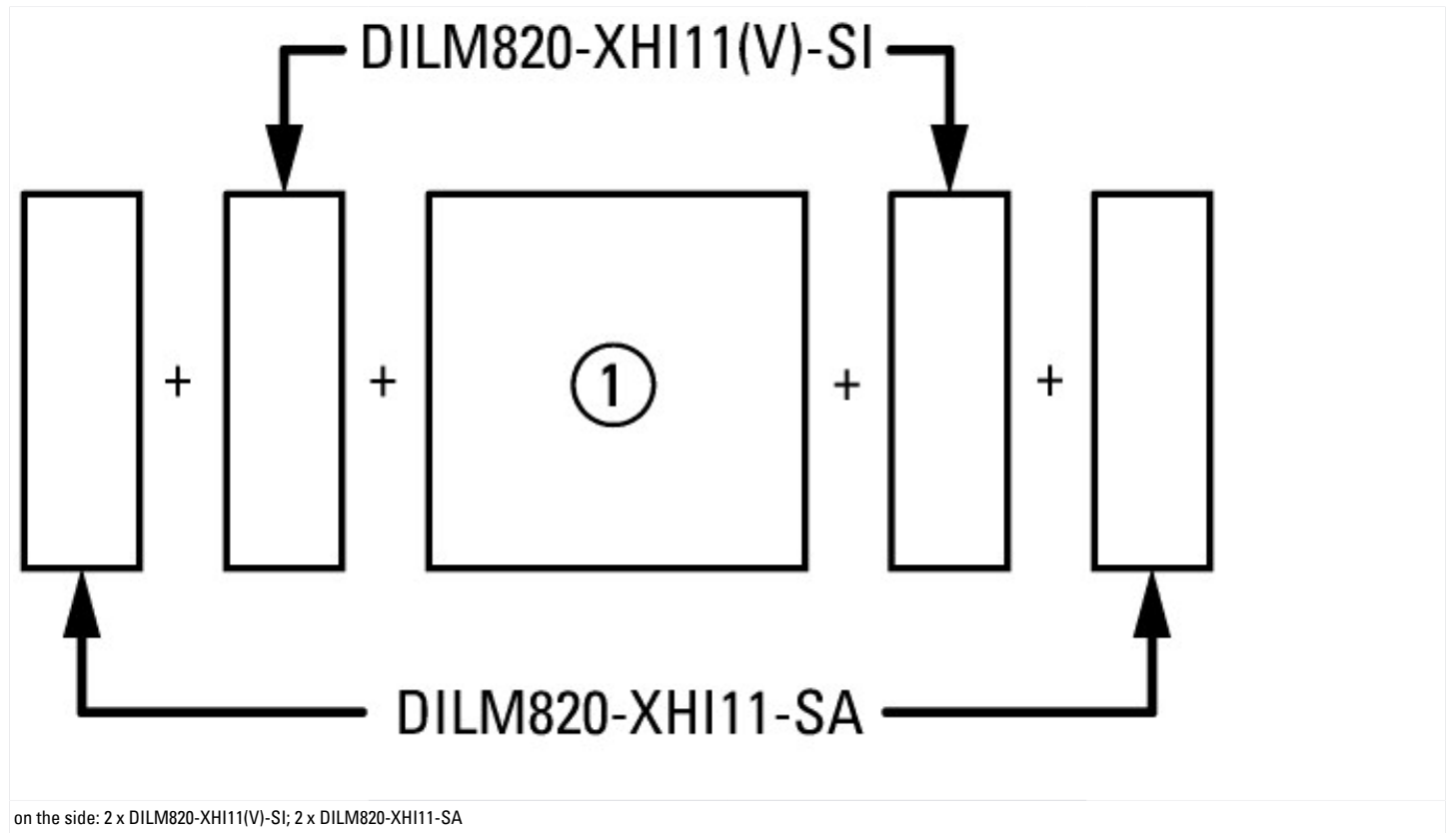

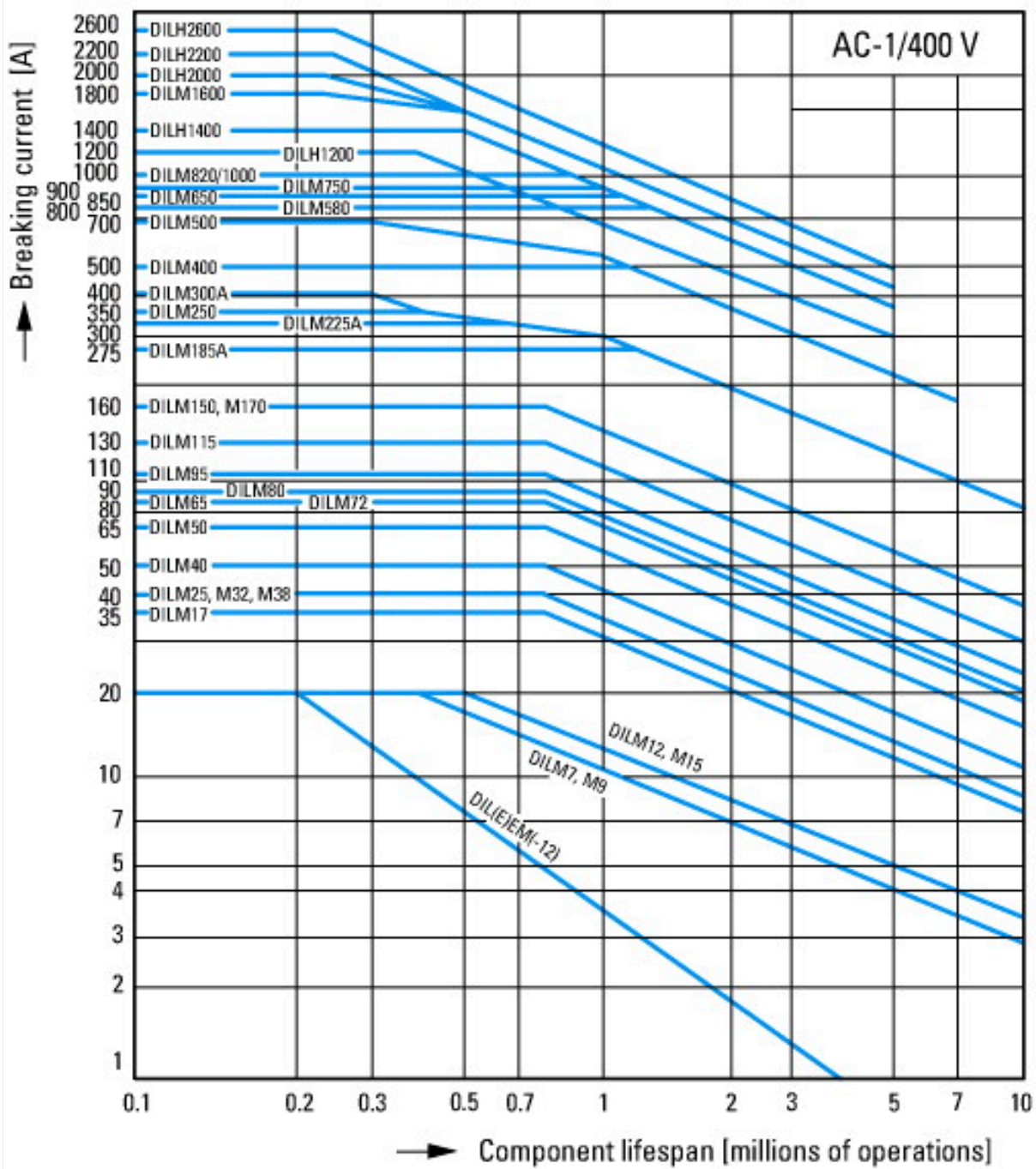

Switching conditions for 3 pole, non-motor loads
 Operating characteristics
 Non inductive and slightly inductive loads
 Electrical characteristics
 Switch on: 1 x rated operational current
 Switch off: 1 x rated operational current
 Utilization category
 100 % AC-1
 Typical examples of application
 Electric heat

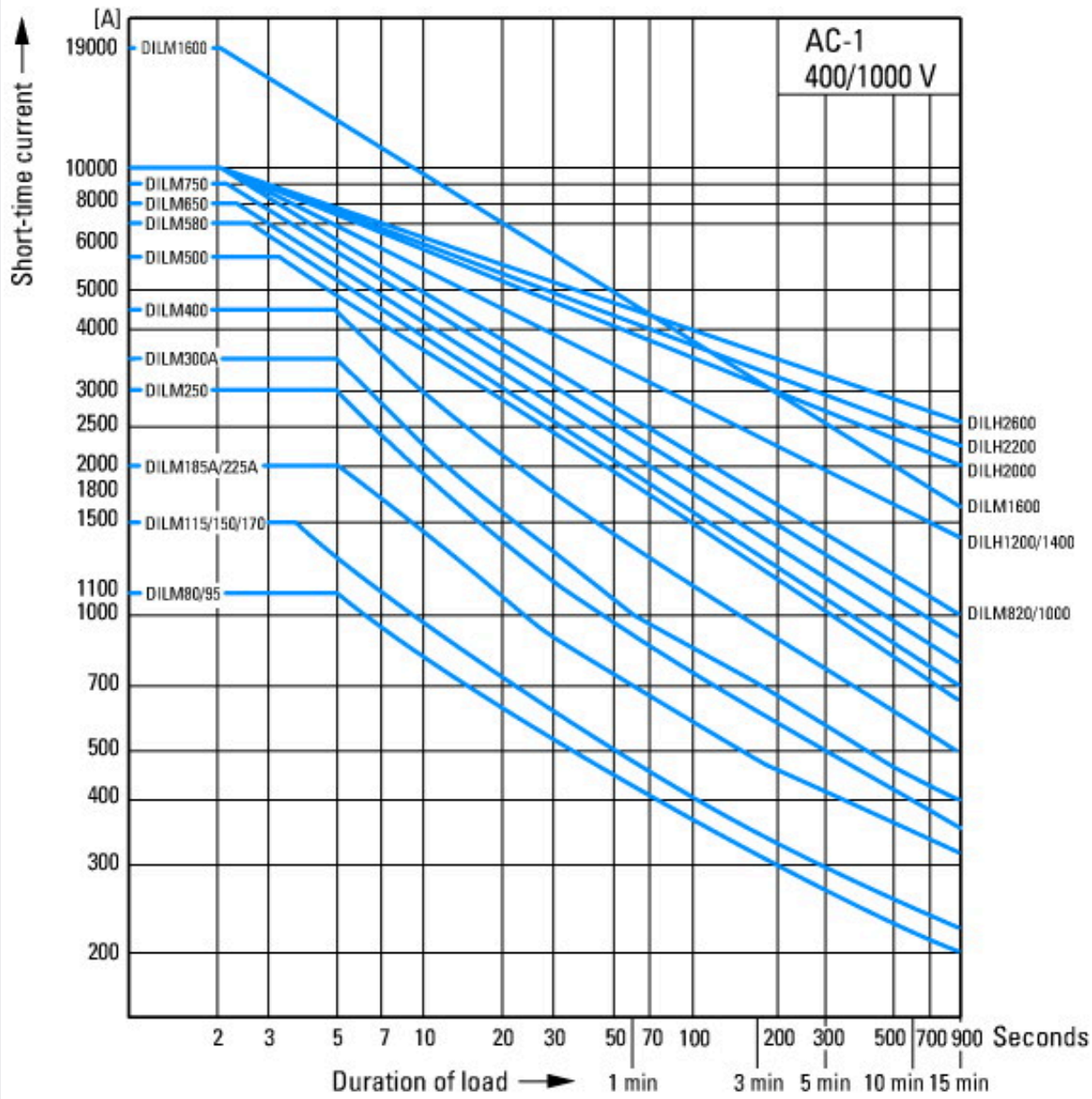

Short-time loading, 3-pole
 Time interval between two loading cycles: 15 minutes

Dimensions

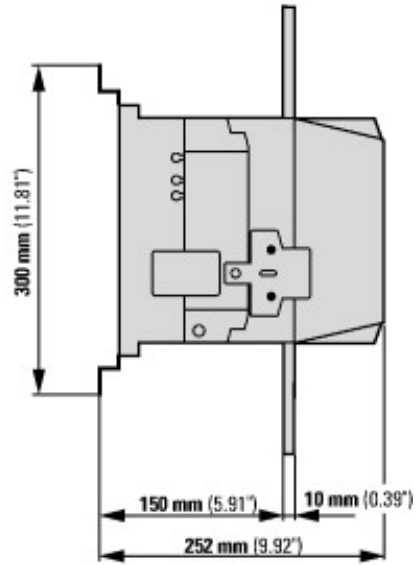
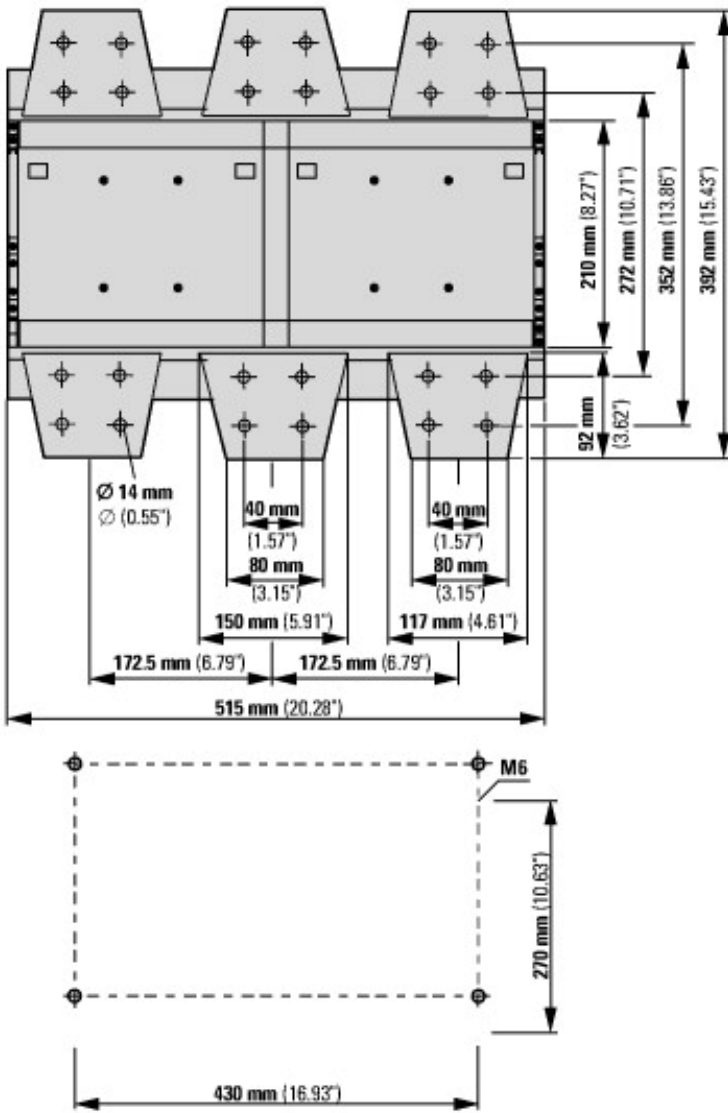

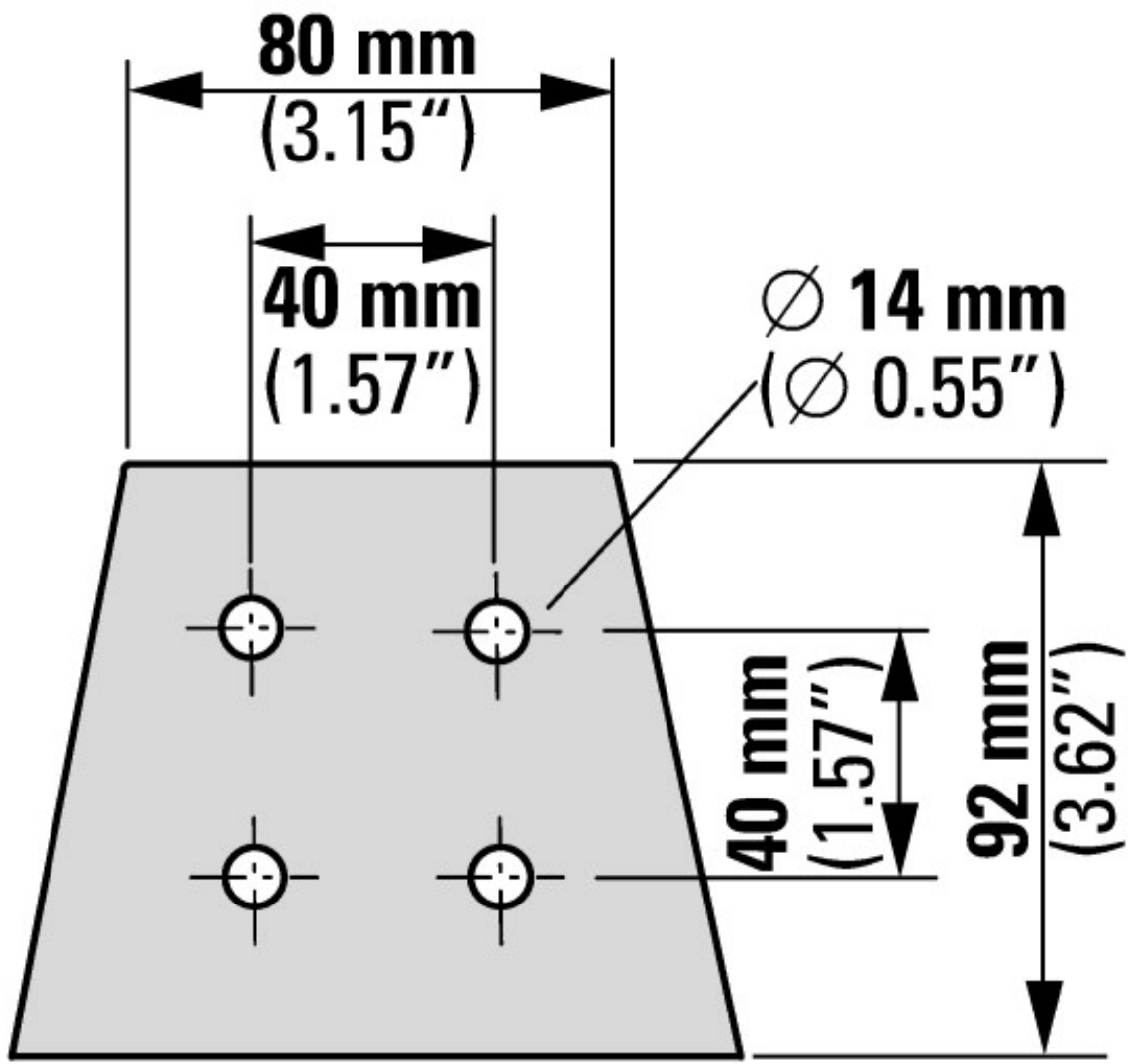

DILM1600
DILH2000, DILH2200