

**Specifications**

Nominal Voltage		12 V
Capacity (25°C)	10HR(10.8V)	75 Ah
	5HR(10.5V)	65Ah
	1HR(9.60V)	46.5Ah
Dimension	Length	562±2mm (22.13inch)
	Width	114±2mm (4.49inch)
	Height	189±2mm (7.44inch)
	Total Height	189±2mm (7.44inch)
Approx. Weight		25kg (55.1lbs) ±4%
Terminal type		M8 threaded post
Internal resistance (Fully charged, 25°C)		Approx. 6mΩ
Capacity affected by temperature (10HR)	40°C	102%
	25°C	100%
	0°C	85%
	-15°C	65%
Self-discharge (25°C)	3 month	Remaining Capacity: 91%
	6 month	Remaining Capacity: 82%
	12 month	Remaining Capacity: 65%
Nominal operating temperature		25°C ± 3°C (77°F ± 5°F)
Operating temperature range	Discharge	-15°C ~ 50°C (5°F ~ 122°F)
	Charge	-10°C ~ 50°C (14°F ~ 122°F)
	Storage	-20°C ~ 50°C (-4°F ~ 122°F)
Float charging voltage(25°C)		13.50 to 13.80V Temperature compensation: -18mV/°C
Cyclic charging voltage(25°C)		14.50 to 14.90V Temperature compensation: -30mV/°C
Maximum charging current		22.5A
Terminal material		M8 threaded post
Maximum discharge current		600A(5 sec.)
Designed floating life(20°C)		12 years

- ◆ Absorbent glass mat technology;
- ◆ Recognized by UL & CE;
- ◆ ABS container.

**Constant Current Discharge Characteristics (A, 25°C)**

F.V/TIME	15min	30min	60min	2h	3h	4h	5h	6h	8h	10h	20h
9.60V	121	73.5	46.5	27.4	19.1	15.7	13.4	11.7	9.18	7.64	4.01
9.90V	118	72.0	45.8	27.2	19.0	15.6	13.3	11.6	9.13	7.62	4.00
10.2V	114	69.8	44.6	27.0	18.9	15.5	13.2	11.6	9.06	7.60	3.99
10.5V	110	68.1	43.8	26.6	18.8	15.4	13.1	11.5	9.00	7.55	3.97
10.8V	104	65.6	42.4	25.9	18.2	14.9	12.7	11.1	8.73	7.50	3.94

**Constant Power Discharge Characteristics (Watt, 25°C)**

F.V/TIME	15min	30min	60min	2h	3h	4h	5h	6h	8h	10h	20h
9.60V	1332	825	530	317	225	184	158	138	109	91.2	48.1
9.90V	1300	808	522	315	224	183	157	138	108	91.0	48.0
10.2V	1252	783	509	313	222	182	156	137	108	90.7	47.9
10.5V	1209	764	499	308	221	181	155	136	107	90.2	47.6
10.8V	1145	736	483	300	214	175	150	132	104	89.6	47.3

Note: The above characteristics data can be obtained within three charge/discharge cycles.

**Dimensions**

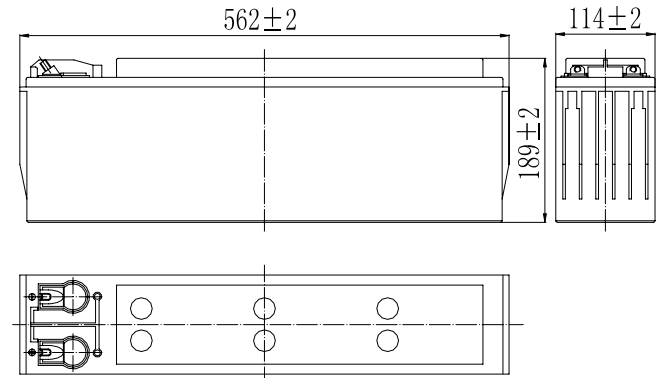

**Terminal**

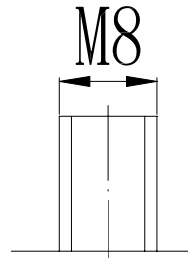

Discharge Characteristics(25°C)

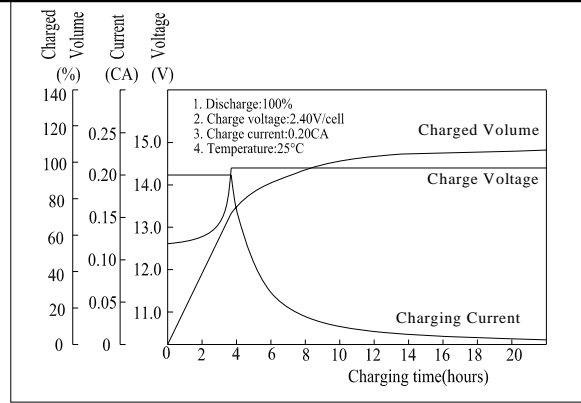
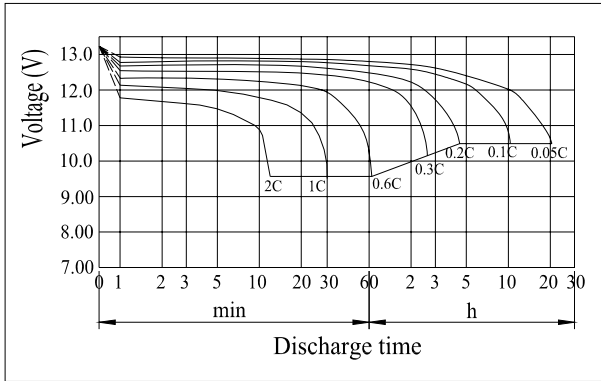

Effect of Temperature on Capacity

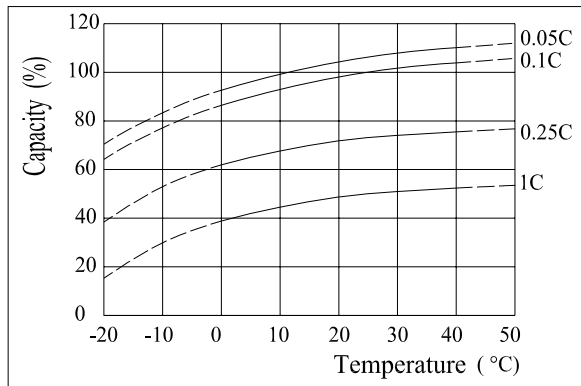

Self-discharge Characteristics

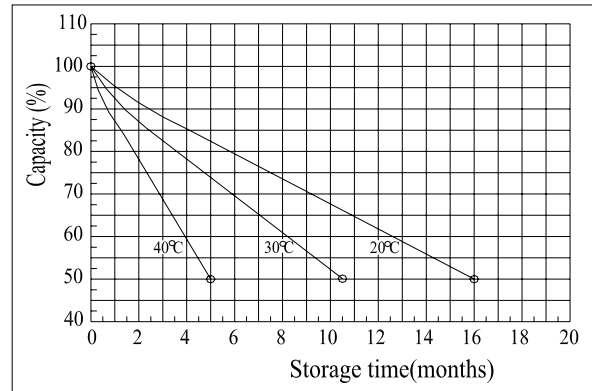

The Relationship for Open Circuit Voltage and Residual Capacity (25°C)

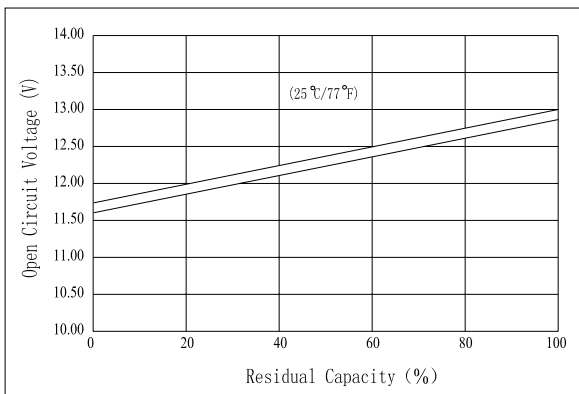

The Relationship for Charging Voltage and Temperature

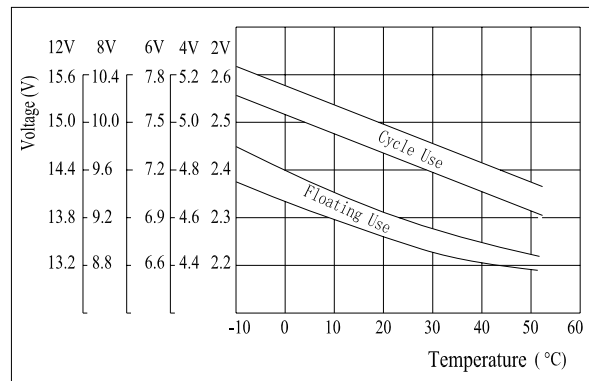

Floating Life on Temperature

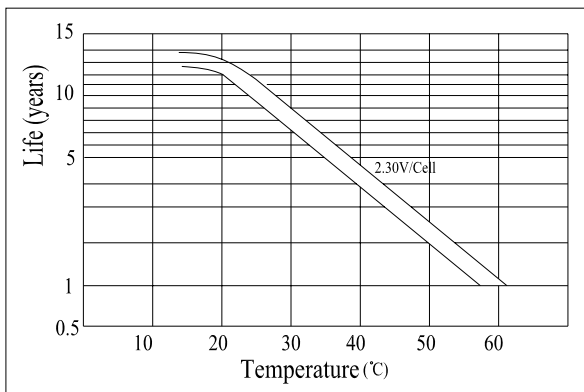

Cycle Life on D.O.D(25°C)

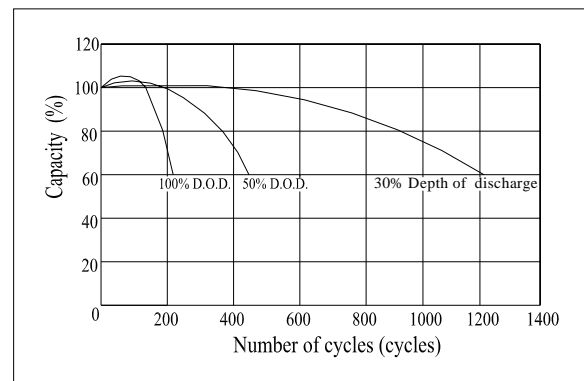

Charging Characteristics(25°C)