

QUICK GUIDE

Installation and commissioning



Wi-Fi
door station

vidoor

Contents

Product data	4
Technical data	6
Preparing for assembly and configuration	7
Registration and logging in	9
Device configuration in CallMe app	10
Calls in the CallMe app	14
Barrier-free communication for system status	15

Introduction

Please read this quick guide thoroughly before installation and commissioning. Before making any changes to the door station, read the relevant sections of the quick guide.



Detailed information on how to install, configure and operate the VIDOORA door station can be found in the installation and operating instructions. Make sure to observe the safety instructions listed there.



Checking the delivery

- Before anything else, please check the packaging and the contents for any visible damage.
- If you notice any damage on the packaging, please document it before opening the packaging.
- Open the packaging carefully, so that you can reuse it for a potential return shipment.
- If parts are missing or if you notice any damage, please contact your retailer immediately.
- Important: Do not attempt to operate the device if parts are missing or damaged.
- If you need to return the device to the retailer (because parts are missing or damaged), please use the original packaging.

Scope of delivery

- VIDOORA Wi-Fi door station
- Installation material
- Quick guide

Product data

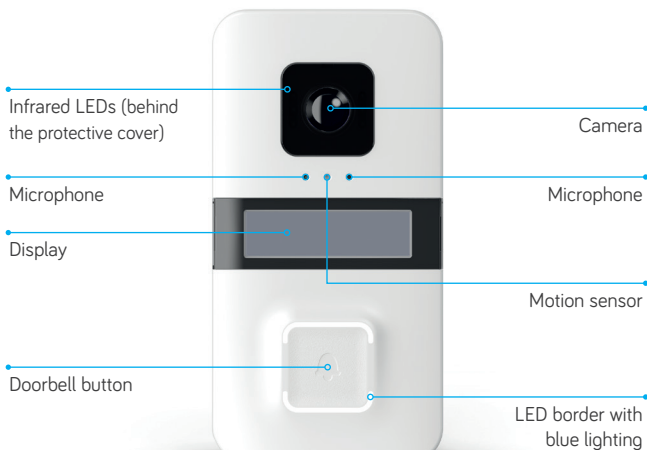

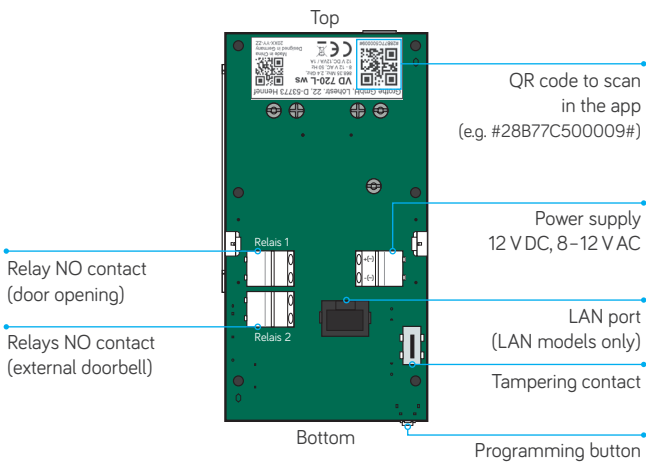
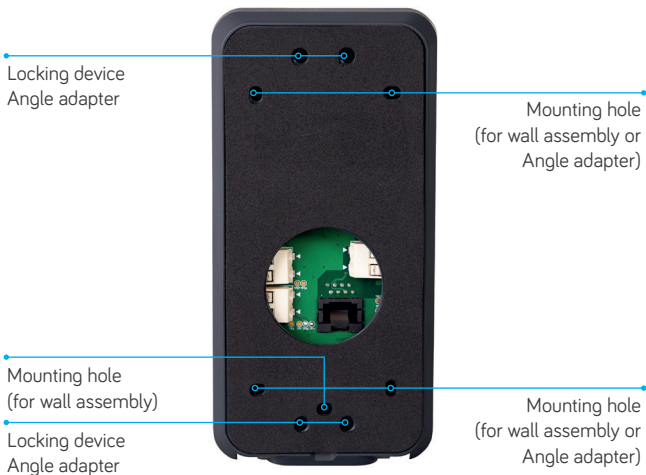

Technical data

Camera resolution	HD 720p; 1280 x 720 px
Compression standard	H.264
Camera perspective	120° (H), 93° (V), 160° (D)
Display size	128 x 32 pixels
Wi-Fi frequency	2,4 GHz
Wi-Fi standard	802.11 b/g/n
Transmission frequency of transmitter MISTRAL / CALIMA	868.35 MHz
Transmitter range MISTRAL / CALIMA	150 m
Max. volume	80 dBA @ 1 m
Number of infrared LEDs (IR LEDs)	6
Range of IR LEDs	3 m
Relay switching capacity	12 V AC/DC, max. 2 A
Temperature range	-20°C to +50°C
Power supply	12 V DC or 8-12 V AC (50 Hz)
Protection class	IP55 (IK07)
Weight	210 g
Dimensions (W x H x D)	80 x 156 x 35 mm

Preparing for assembly and configuration

Positioning

Select a position that enables the camera to capture all visitors at face-height. The perspective of the camera must also be taken into account.

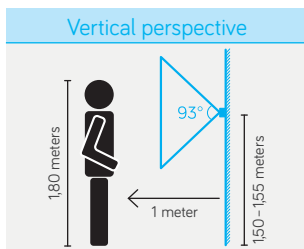
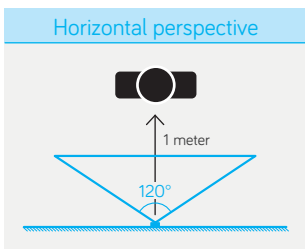

Recommended installation height (bottom edge of the door station, measured from the ground up): 1.50–1.55 meters.

Assembly

Open the housing by removing the screws on the bottom section and carefully folding the housing open. Make sure to fold open the lower part of the front section first.

1. Assemble the lower part of the VIDOORA door station's housing on the wall with the installation material provided.
2. When installing on a flush-mounted box, break out the pre-punched mounting holes in the rear cover using a suitable tool.

Installation

1. While de-energized, connect the wires for the power supply.

Upper terminal connection	~ (+)
Lower terminal connection	~ (-)
DC voltage range	12 V DC
AC voltage range	8-12 V AC (50 Hz)

2. Switch on the power supply via the upstream fuse element.



VIDOORA will switch to configuration mode after switching on for the first time (after approx. 30 seconds, the blue LED border of the doorbell flashes, the display shows "Configuration").

Registration and logging in

1. Download the Urmet CallMe app from the Apple Store (iOS) or Play Store (Android) and create a new user account in the CallMe app.
2. Create a password with the following minimum requirement:
 - At least 6 characters
 - At least 1 uppercase letter
 - At least 1 lowercase letter
 - At least 1 number
 - At least 1 special character
 - The user name cannot be part of the password
3. Activate the user account via the validation link in the e-mail that you have received.
4. Open the app and log in with the newly created user account or with an existing user account. Give the app the following permissions:
 - Access to photos, multimedia content and files on the device
 - Video recording
 - Taking photos and videos
 - Make and manage phone calls

Device configuration in the CallMe app



Make sure to use the end user's account during the configuration! When the door station is ready, it sends all calls to the user account used in the configuration.

Start configuration

1. Make sure the doorbell's border flashes blue and the word "Configuration" is shown on the display of the door station.
2. On the start page of the app, select "Settings" and then the menu item "Installation and maintenance."
3. Select the "7540X" option.
4. To scan the QR code for the door station, tap on "Scan" (the camera opens with a scan window). Scan the QR code on the door station.
5. Make sure the doorbell's border flashes blue and the word "Configuration" is shown on the display. Tap on "Next."

TIP: For a detailed description of the individual steps, please read the installation and operating instructions.



Connecting

1. Connect your smartphone and the door station via Wi-Fi. To do so, exit the app (but do not close it) and go to the Wi-Fi settings on your smartphone. Select the hotspot of the door station (name: call_CFW_xxxx). Enter the password when prompted.

PASSWORD: The last four characters of the name of the door station twice with the separator “-” in between.
Example: “1234-1234”

2. When the Wi-Fi hotspot and smartphone are connected, go back to the CallMe app and tap on “Next”.

Configuration

1. Name the door station. This is the name that will be displayed in the app when a call comes in from the doorbell.
2. Select the connection type “Wireless (predefined)” between the door station and the router.
3. Optional: Specify time periods for automatic deactivation of the Wi-Fi connection, e.g., during the night.
4. Specify “Standard” IP addressing.
5. Specify the video quality for displaying the video image in the app. Please select a value that matches the data volume and internet connection.

Define relevant door station parameters

Name plate	Name of the door station that appears in the display (Two lines, max. 14 characters per line)
Loudspeaker	Volume of the loudspeaker in the door station
DDA function	Display and voice output of the system status (barrier-free communication)
CIP function	When the doorbell rings, an alpha tone sounds at the door station; the visitor receives confirmation that the door call has been made.

Additional relay functions (when pressing the bell button)

Wireless door release relay	The Grothe wireless door release relay (optional) is activated when "Open door" is pressed in the app after accepting the call.
Door relay time	Control time of the door release
Second relay	When the doorbell button is pressed, the door station activates the second relay at the same time as the call to the smartphone, e.g. for an electromechanical doorbell

- To transfer all configured parameters to the door station, complete the settings with “Save” and in the next window with “Next”.
- After the data transfer, VIDOORA restarts and then connects to the specified network. The door station is ready for use with the CallMe app as soon as the name entered appears on the door station display.

Requirements for receiving calls in the CallMe app

- The smartphone is enabled to receive notifications for the CallMe app (can be set in the app).
- The app is open.
- The app is always active in the background (to do so, deactivate apps that optimize battery usage or energy savings of the smartphone, or put apps in sleep mode).
- A good quality internet connection.
- Any virus protection programs on the smartphone are inactive or exceptions have been provided for the CallMe app.
- The provider is not blocking VoIP streams on the smartphone.

Calls in the CallMe app

For information on additional functions of the CallMe app and detailed instructions on the installation steps, please refer to the installation and operating instructions.



Incoming call

Accept call

Show image

Reject call

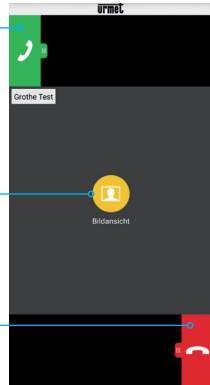

Accepted call

Mute caller

Open gate

Wi-Fi signal quality

Loudspeaker

End call

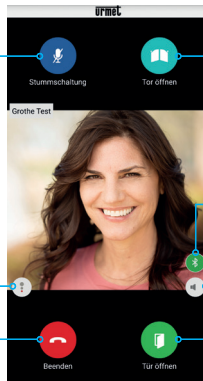

Open door



Barrier-free communication for system status

System status information for people with hearing or visual impairments:

- Easily audible and understandable voice output
- Easily identifiable symbols on the display

	Ringing active	Prompt to speak	Door opens
Indication on the display			
Speech announcement	“Calling now”		“The door is open”

GOOD TO KNOW: The VIDOORA door station fulfils the requirements for barrier-free communication systems according to DIN 18040-1.



The manufacturer is in no way liable for damage caused by improper use of the devices described in these operating instructions.

The manufacturer also reserves the right to change the contents of these instructions without prior notification.

The information provided in these operating instructions was meticulously compiled and checked. Regardless of this, the manufacturer cannot be held liable for the use of these installation and operating instructions. Nor can persons or companies that have been consulted for the preparation and creation of these instructions be held liable.

VIDOORA is a product brand of Grothe GmbH.

Grothe GmbH

Building services engineering from
a single source – From A to Z

Grothe GmbH
Löhestraße 22
D-53773 Hennef
Phone: +49 (0)2242 8890-0
Fax: +49 (0)2242 8890-36
info@grothe.de
www.grothe.de
www.vidoora.de

Service hotline

Phone: +49 (0) 2242 8890-56
Fax: +49 (0) 2242 8890-37
service@grothe.de
www.grothe.de

GROTHE
URMET | GROUP