

CATALOG

# Wiring Accessories

## Impressivo and Jussi



- Full range of functions required in electrical installation
- Easy to install and reliable to use
- For flush and surface mounting

---

**ABB wiring accessories are easy to install and reliable to use.**

**The product range is constantly expanded and existing products are developed, while maintaining their compatibility and availability.**



# Table of contents

|                                  |    |
|----------------------------------|----|
| <b>01. Impressivo</b>            | 04 |
| <b>02. Jussi</b>                 | 36 |
| <b>03. Electronics</b>           | 58 |
| <b>04. Technical information</b> | 72 |



**01**

**Impressivo**

**When style and functionality matter.**



|  |    |
|--|----|
| <b>Flush mounting</b>                  |    |
| Switches and push switches             | 10 |
| Signal lights                          | 15 |
| Socket outlets                         | 15 |
| Tele and data                          | 19 |
| <b>Accessories</b>                     |    |
| IP44 sealing                           | 25 |
| Accessories                            | 25 |
| Cover frames                           | 27 |
| Design frames                          | 28 |
| <b>Surface mounting</b>                |    |
| Switches                               | 31 |
| Socket outlets                         | 32 |
| Surface mounting boxes and accessories | 33 |





---

## For modern-day minimalists

Impressivo is ideal for those who want a life less complicated. It's modernity and simplicity in one and lends itself perfectly to lovers of stylish, no-frill surroundings.

—  
01

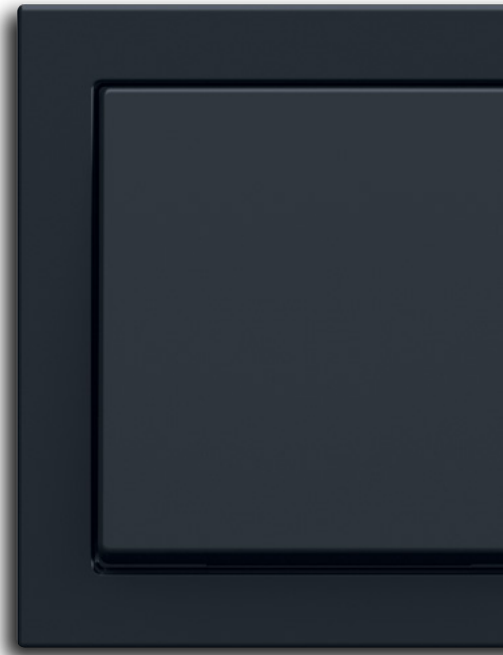

—  
01

**Illustration in original size**

The cover frame measures 85 mm x 85 mm x 16 mm (w x h x d). Material: the rocker and frame are made of thermoplastic (PC), impact- and break-proof, UV-resistant, PVC- and halogen-free

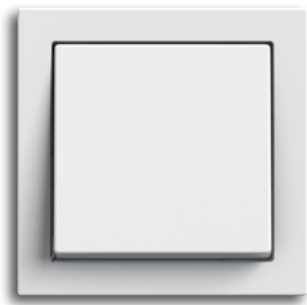

01



---

## Impressivo

Keeping things simple

Impressivo is the choice when you prefer clarity over complexity. Today's fans of straight forward functional aesthetics will be in their element.





- 01 white
- 02 aluminium
- 03 anthracite



—  
02



—  
03

## Impressivo flush mounting

### Switches



#### Flush mounting 1-gang switches, IP21

Switches with screwless terminals and rocker with clip-on fastening. The terminals are for max 2 rigid wires. Flush mounting on a smooth surface IP21.

| Type   | EAN           | Description  | Package |
|--|---------------|--|---------|
| <b>Includes switch insert and rocker</b>     |               |  |         |
| 1066UC-84                                    | 6438199001302 | 1-gang 2-way switch, 16AX/250 V, Impressivo, 2 X-terminals, white                    | 1/10    |
| 1067UC-84                                    | 6438199001333 | 1-gang intermediate switch, 16AX/250 V, Impressivo, 2 X-terminals, white             | 1/10    |
| <b>Modular</b>                               |               |  |         |
| 1066.21                                      | 6418677328626 | 1-gang 2-way switch insert, 16AX/250 V, 2 X-terminals, lamp possibility              | 10/100  |
| 1067.21                                      | 6418677328664 | 1-gang intermediate switch insert, 16AX/250 V, 2 X-terminals, lamp possibility       | 10/100  |
| 10662.00                                     | 6418677328657 | Double pole 1-gang 2-way switch insert, 16AX/250 V, no X-terminals, lamp possibility | 10/100  |
| 1786-84                                      | 6418677328855 | Switch rocker, Impressivo, 1-gang, white   | 1/10    |
| 1786-81                                      | 6418677328879 | Switch rocker, Impressivo, 1-gang, anthracite  | 1/10    |
| 1786-83                                      | 6418677328886 | Switch rocker, Impressivo, 1-gang, aluminum  | 1/10    |
| <b>Design series. Delivery time 3 weeks.</b> |               |  |         |
| 1786-866                                     | 4011395086018 | Switch rocker, 1-gang, steel   | 1/10    |
| 1786-884                                     | 4011395129289 | Switch rocker, 1-gang, white matt  | 1       |
| 1786-885                                     | 4011395129753 | Switch rocker, 1-gang, black matt  | 1       |



#### Flush mounting 1-gang 1-way push switch, IP21

Push switches with screwless terminals and rocker with clip-on fastening. The terminals are for max 2 rigid wires. Flush mounting on a smooth surface IP21.

| Type   | EAN           | Description  | Package |
|--|---------------|--|---------|
| <b>Includes switch insert and rocker</b>     |               |  |         |
| 1466UC-84                                    | 6438199001425 | 1-gang 2-way push switch, 16A/250 V, Impressivo, 1N terminal, white        | 1/10    |
| <b>Modular</b>                               |               |  |         |
| 1461.21                                      | 6418677328817 | 1-gang 1-way push switch insert 16A/250 V, 2 X-terminals, lamp possibility | 10/100  |
| 1786-84                                      | 6418677328855 | Switch rocker, Impressivo, 1-gang, white                                   | 1/10    |
| 1786-81                                      | 6418677328879 | Switch rocker, Impressivo, 1-gang, anthracite                              | 1/10    |
| 1786-83                                      | 6418677328886 | Switch rocker, Impressivo, 1-gang, aluminum                                | 1/10    |
| 1789LI-84                                    | 6418677334498 | Switch rocker, Impressivo, 1-gang, "light" symbol, lens, white             | 1/10    |
| 1789LI-81                                    | 6418677334511 | Switch rocker, Impressivo, 1-gang, "light" symbol, lens, anthracite        | 1/10    |
| 1789LI-83                                    | 6418677334528 | Switch rocker, Impressivo, 1-gang, "light" symbol, lens, aluminum          | 1/10    |
| <b>Design series. Delivery time 3 weeks.</b> |               |  |         |
| 1786-866                                     | 4011395086018 | Switch rocker, 1-gang, steel   | 1/10    |
| 1786-884                                     | 4011395129289 | Switch rocker, 1-gang, white matt  | 1       |
| 1786-885                                     | 4011395129753 | Switch rocker, 1-gang, black matt  | 1       |
| 1789LI-866                                   | 4011395086087 | Switch rocker, 1-gang, "light" symbol, lens, steel                         | 1/10    |
| 1789LI-884                                   | 4011395129418 | Switch rocker, 1-gang, "light" symbol, lens, white matt                    | 1       |
| 1789LI-885                                   | 4011395129821 | Switch rocker, 1-gang, "light" symbol, lens, black matt                    | 1       |



**Flush mounting 2-pole switch, IP21**

Switches with screwless terminals and rocker with clip-on fastening. The terminals are for max 2 rigid wires. Flush mounting on a smooth surface IP21.

| Type   | EAN           | Description  | Package |
|--|---------------|--|---------|
| <b>Includes switch insert and rocker</b>     |               |  |         |
| 1062UC-84                                    | 6438199001180 | 2-pole 1-gang 1-way switch, 16AX/250 V, Impressivo, 2 X-terminals, white | 1/10    |
| <b>Modular</b>                               |               |  |         |
| 1062.21                                      | 6418677328633 | Switch insert, 16AX/250 V, 2-pole, 2 X-terminals, lamp possibility       | 10/100  |
| 1788-81                                      | 6418677328954 | Switch rocker, Impressivo, 1-gang, red lens, "1/0" symbol, anthracite    | 1/10    |
| 1788-83                                      | 6418677328961 | Switch rocker, Impressivo, 1-gang, red lens, "1/0" symbol, aluminum      | 1/10    |
| <b>Design series. Delivery time 3 weeks.</b> |               |  |         |
| 1788-866                                     | 4011395086322 | Switch rocker, 1-gang, red lens, "1/0" symbol, steel                     | 1/10    |
| 1788-884                                     | 4011395129319 | Switch rocker, 1-gang, red lens, "1/0" symbol, white matt                | 1       |
| 1788-885                                     | 4011395129760 | Switch rocker, 1-gang, red lens, "1/0" symbol, black matt                | 1       |



**Lamps for switches**

Lamps for switches and push buttons. Lamps can be installed in 1-gang switch inserts that include the signal-/ search light possibility. Lamps can't be installed in 2- or 3-gang switch inserts.

| Type  | EAN           | Description  | Package |
|-------|---------------|--|---------|
| 8370  | 6410021060701 | Lamp, 230 V/0.4 mA, fluorescent, for 1-gang switches | 10/100  |
| 8372  | 6410021060725 | Lamp, 230 V/2 mA, fluorescent, for 1-gang switches   | 10/100  |
| 8375  | 6410021060756 | Lamp, 24 V/22 mA, incandescent, for 1-gang switches  | 10/100  |
| 8376  | 6410021060763 | Lamp, 12 V/40 mA, incandescent, for 1-gang switches  | 10/100  |
| 8370R | 6438199004860 | Lamp, 250 V/0.4 mA, LED, for 1-gang switches         | 10/100  |
| 8375R | 6438199004877 | Lamp, 5-24 V/0.5-2.5 mA, LED, for 1-gang switches    | 10/100  |



**Flush mounting 2-gang switches, IP21**

Switches with screwless terminals and rocker with clip-on fastening. The terminals are for max 2 rigid wires. Flush mounting on a smooth surface IP21.

| Type   | EAN           | Description   | Package |
|--|---------------|---|---------|
| <b>Includes switch insert and rocker</b>     |               |   |         |
| 1065UC-84                                    | 6438199001241 | 2-gang 1-way switch, 16AX/250 V, Impressivo, 2 X-terminals, white           | 1/10    |
| 10666UC-84                                   | 6438199001272 | 2-gang 2-way switch, 16AX/250 V, Impressivo, no X-terminals, white          | 1/10    |
| <b>Modular</b>                               |               |   |         |
| 1065.20                                      | 6418677328756 | 2-gang 1-way switch insert, 16AX/250 V, 2 X-terminals, no lamp possibility  | 10/100  |
| 10666.00                                     | 6418677328763 | 2-gang 2-way switch insert, 16AX/250 V, no X-terminals, no lamp possibility | 10/100  |
| 1785-84                                      | 6418677329098 | Switch rocker, Impressivo, 2-gang, white                                    | 1/10    |
| 1785-81                                      | 6418677329111 | Switch rocker, Impressivo, 2-gang, anthracite                               | 1/10    |
| 1785-83                                      | 6418677329128 | Switch rocker, Impressivo, 2-gang, aluminum                                 | 1/10    |
| <b>Design series. Delivery time 3 weeks.</b> |               |   |         |
| 1785-866                                     | 4011395086346 | Switch rocker, 2-gang, steel  | 1/10    |
| 1785-884                                     | 4011395129210 | Switch rocker, 2-gang, white matt   | 1       |
| 1785-885                                     | 4011395129685 | Switch rocker, 2-gang, black matt   | 1       |



**Flush mounting 2-pole + 1-way switch, IP21**

The switch has one 1-way switch and one 2-pole 1 switch together. Switches with screwless terminals and rocker with clip-on fastening. The terminals are for max 2 rigid wires. Flush mounting on a smooth surface IP21.

| Type                                     | EAN           | Description  | Package |
|--|---------------|--|---------|
| <b>Includes switch insert and rocker</b> |               |  |         |
| 10621UC-84                               | 6438199001159 | 2-pole 2-gang 1-way switch, Impressivo, no X-terminals, white      | 1/10    |
| 10621UC-81                               | 6438199001135 | 2-pole 2-gang 1-way switch, Impressivo, no X-terminals, anthracite | 1/10    |
| 10621UC-83                               | 6438199001142 | 2-pole 2-gang 1-way switch, Impressivo, no X-terminals, aluminum   | 1/10    |



### 2-gang push switch inserts

2-gang push switches with screwless terminals and rocker with clip-on fastening. The terminals are for max 2 rigid wires. Flush mounting on a smooth surface IP21.

| Type   | EAN           | Description   | Package |
|--|---------------|---|---------|
| <b>Modular</b>                               |               |   |         |
| 2020/4U-101                                  | 6418677304217 | Push switch insert 10A/250V, for up/down control                | 10/100  |
| 1785JA-84                                    | 6418677329135 | Switch rocker, Impressivo, 2-gang, "up/down" symbol, white      | 1/10    |
| 1785JA-81                                    | 6418677329159 | Switch rocker, Impressivo, 2-gang, "up/down" symbol, anthracite | 1/10    |
| 1785JA-83                                    | 6418677329166 | Switch rocker, Impressivo, 2-gang, "up/down" symbol, aluminum   | 1/10    |
| <b>Design series. Delivery time 3 weeks.</b> |               |   |         |
| 1785JA-866                                   | 4011395086681 | Switch rocker, 2-gang, "up/down" symbol, steel                  | 1/10    |
| 1785JA-884                                   | 4011395129173 | Switch rocker, 2-gang, "up/down" symbol, white matt             | 1       |
| 1785JA-885                                   | 4011395129531 | Switch rocker, 2-gang, "up/down" symbol, black matt             | 1       |



### Flush mounting 3-gang 1-way switch, IP21

Switches with screwless terminals and rocker with clip-on fastening. The terminals are for max 2 rigid wires. Flush mounting on a smooth surface IP21.

| Type                                     | EAN           | Description   | Package |
|--|---------------|---|---------|
| <b>Includes switch insert and rocker</b> |               |   |         |
| 10631UC-84                               | 6438199001210 | 3-gang 1-way switch, 16AX/250 V, Impressivo, no X-terminals, white          | 1/10    |
| <b>Modular</b>                           |               |   |         |
| 10631.00                                 | 6418677328794 | 3-gang 1-way switch insert, 16AX/250 V, no X-terminals, no lamp possibility | 10/100  |
| 1783-81                                  | 6418677329234 | Switch rocker, Impressivo, 3-gang, anthracite                               | 1/10    |
| 1783-83                                  | 6418677329241 | Switch rocker, Impressivo, 3-gang, aluminum                                 | 1/10    |



### Flush mounting 1-gang 2-way switch, IP44

Product includes switch insert, rocker, cover frame, screw-mounted rocker frame and seal. Screwless terminals are for max 2 rigid wires. Flush mounting on rough surface IP44.

| Type      | EAN           | Description   | Package |
|-----------|---------------|---|---------|
| 1066UW-84 | 6438199000022 | 1-gang 2-way switch, 16AX/250 V, Impressivo, no X-terminals, IP44 | 1/10    |

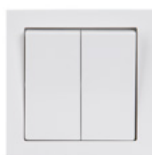

### Flush mounting 2-gang 1-way switch, IP44

Product includes switch insert, rocker, cover frame, screw-mounted rocker frame and seal. Screwless terminals are for max 2 rigid wires. Flush mounting on rough surface IP44.

| Type      | EAN           | Description   | Package |
|-----------|---------------|---|---------|
| 1065UW-84 | 6438199000039 | 2-gang 1-way switch, 16AX/250 V, Impressivo, no X-terminals, IP44 | 1/10    |



### Card switch

Card switch can be used, for example, as a hotel room "main switch". The card switch is operated with a credit card sized card. Delivery includes a 230V lamp.

| Type     | EAN           | Description   | Package |
|----------|---------------|---|---------|
| 8114.1   | 6438199000534 | Card switch insert, 16AX/250 V, 2-pole, no X terminals, lamp included | 10/100  |
| 1792-84  | 6418677329258 | Center plate, Impressivo, for card switch 8114.1, white               | 1/10    |
| 1792-81  | 6418677329272 | Center plate, Impressivo, for card switch 8114.1, anthracite          | 1/10    |
| 1792-83  | 6418677329289 | Center plate, Impressivo, for card switch 8114.1, aluminum            | 1/10    |
| 1792-866 | 4011395086797 | Center plate, for card switch 8114.1, steel                           | 10      |
| 1792-884 | 4011395131664 | Center plate, for card switch 8114.1, white matt                      | 1       |
| 1792-885 | 4011395127285 | Center plate, for card switch 8114.1, black matt                      | 1       |
| 8331     | 6410021060909 | Lamp, 230 V/1.5 mA, fluorescent, for card switch                      | 10/100  |



**Push button panel 4/2-gang, 5-24V ac/dc**

4/2-gang push button panel to control bistable relays or electronic control systems. Load capacity 1A AC/DC. White LED-light with adjustable illumination. Installation on surface or on top of a standard flush mounting box.

| Type       | EAN           | Description                                   | Package |
|------------|---------------|---|---------|
| FAP1204-84 | 6438199002309 | Push button, 4/2-gang, Impressivo, white      | 1/10    |
| FAP1204-81 | 6438199002286 | Push button, 4/2-gang, Impressivo, anthracite | 1/10    |
| FAP1204-83 | 6438199002293 | Push button, 4/2-gang, Impressivo, aluminum   | 1/10    |

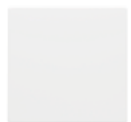

**1-gang rockers, IP21/IP44**

1-gang rockers for all 1-gang switch inserts. Flush- and surface mounting: Protection class IP21, and IP44 with a seal and screw fastening rocker frame.

| Type   | EAN           | Description                                   | Package |
|--|---------------|---|---------|
| 1786-84                                      | 6418677328855 | Switch rocker, Impressivo, 1-gang, white      | 1/10    |
| 1786-81                                      | 6418677328879 | Switch rocker, Impressivo, 1-gang, anthracite | 1/10    |
| 1786-83                                      | 6418677328886 | Switch rocker, Impressivo, 1-gang, aluminum   | 1/10    |
| <b>Design series. Delivery time 3 weeks.</b> |               |   |         |
| 1786-866                                     | 4011395086018 | Switch rocker, 1-gang, steel                  | 1/10    |
| 1786-884                                     | 4011395129289 | Switch rocker, 1-gang, white matt             | 1       |
| 1786-885                                     | 4011395129753 | Switch rocker, 1-gang, black matt             | 1       |



**1-gang rockers with name plate, IP21/IP44**

1-gang rockers for all 1-gang switch inserts. Flush- and surface mounting: Protection class IP21, and IP44 with a seal and screw fastening rocker frame. The rockers have a name plate (59,7 mm x 11,7 mm) with a strip for writing. The delivery includes one blank strip and one strip with the text "MASTER".

| Type   | EAN           | Description  | Package |
|--|---------------|--|---------|
| 1764NLI-84                                   | 6418677328893 | Switch rocker, Impressivo, 1-gang, nameplate, white      | 1/10    |
| 1764NLI-81                                   | 6418677328916 | Switch rocker, Impressivo, 1-gang, nameplate, anthracite | 1/10    |
| 1764NLI-83                                   | 6418677328923 | Switch rocker, Impressivo, 1-gang, nameplate, aluminum   | 1/10    |
| <b>Design series. Delivery time 3 weeks.</b> |               |  |         |
| 1764NLI-866                                  | 4011395086186 | Switch rocker, 1-gang, nameplate, steel                  | 1/10    |
| 1764NLI-884                                  | 4011395131619 | Switch rocker, 1-gang, nameplate, white matt             | 1       |
| 1764NLI-885                                  | 4011395128213 | Switch rocker, 1-gang, nameplate, black matt             | 1       |



**1-gang rockers with red lens, IP21/IP44**

1-gang rockers for all 1-gang switch inserts. Flush- and surface mounting: Protection class IP21, and IP44 with a seal and screw fastening rocker frame. The rockers contain a red lens.

| Type   | EAN           | Description   | Package |
|--|---------------|---|---------|
| 1789-84                                      | 6418677328978 | Switch rocker, Impressivo, 1-gang, red lens, white      | 1/10    |
| 1789-81                                      | 6418677328992 | Switch rocker, Impressivo, 1-gang, red lens, anthracite | 1/10    |
| 1789-83                                      | 6418677329005 | Switch rocker, Impressivo, 1-gang, red lens, aluminum   | 1/10    |
| <b>Design series. Delivery time 3 weeks.</b> |               |   |         |
| 1789-866                                     | 4011395086063 | Switch rocker, 1-gang, red lens, steel                  | 1/10    |
| 1789-884                                     | 4011395129456 | Switch rocker, 1-gang, red lens, white matt             | 1       |
| 1789-885                                     | 4011395129852 | Switch rocker, 1-gang, red lens, black matt             | 1       |



#### 1-gang rockers with transparent lens and "light" symbol, IP21/IP44

1-gang rockers for all 1-gang switch inserts. Flush- and surface mounting: Protection class IP21, and IP44 with a seal and screw fastening rocker frame. The rocker contains transparent lens and "Light" symbol.

| Type   | EAN           | Description   | Package |
|--|---------------|---|---------|
| 1789LI-84                                    | 6418677334498 | Switch rocker, Impressivo, 1-gang, "light" symbol, lens, white      | 1/10    |
| 1789LI-81                                    | 6418677334511 | Switch rocker, Impressivo, 1-gang, "light" symbol, lens, anthracite | 1/10    |
| 1789LI-83                                    | 6418677334528 | Switch rocker, Impressivo, 1-gang, "light" symbol, lens, aluminum   | 1/10    |
| <b>Design series. Delivery time 3 weeks.</b> |               |   |         |
| 1789LI-866                                   | 4011395086087 | Switch rocker, 1-gang, "light" symbol, lens, steel                  | 1/10    |
| 1789LI-884                                   | 4011395129418 | Switch rocker, 1-gang, "light" symbol, lens, white matt             | 1       |
| 1789LI-885                                   | 4011395129821 | Switch rocker, 1-gang, "light" symbol, lens, black matt             | 1       |



#### 1-gang rockers with transparent lens and "key" symbol, IP21/IP44

1-gang rockers for all 1-gang switch inserts. Flush- and surface mounting: Protection class IP21, and IP44 with a seal and screw fastening rocker frame. The rocker contains transparent lens and "key" symbol.

| Type   | EAN           | Description   | Package |
|--|---------------|---|---------|
| 1789TR-84                                    | 6418677329012 | Switch rocker, Impressivo, 1-gang, "key" symbol, lens, white      | 1/10    |
| 1789TR-81                                    | 6418677329036 | Switch rocker, Impressivo, 1-gang, "key" symbol, lens, anthracite | 1/10    |
| 1789TR-83                                    | 6418677329043 | Switch rocker, Impressivo, 1-gang, "key" symbol, lens, aluminum   | 1/10    |
| <b>Design series. Delivery time 3 weeks.</b> |               |   |         |
| 1789TR-866                                   | 4011395086131 | Switch rocker, 1-gang, "key" symbol, lens, steel                  | 1/10    |
| 1789TR-884                                   | 4011395129432 | Switch rocker, 1-gang, "key" symbol, lens, white matt             | 1       |
| 1789TR-885                                   | 4011395129838 | Switch rocker, 1-gang, "key" symbol, lens, black matt             | 1       |



#### 1-gang rockers with transparent lens and "bell" symbol, IP21/IP44

1-gang rockers for all 1-gang switch inserts. Flush- and surface mounting: Protection class IP21, and IP44 with a seal and screw fastening rocker frame. The rocker contains transparent lens and "bell" symbol.

| Type   | EAN           | Description  | Package |
|--|---------------|--|---------|
| 1789KL-84                                    | 6418677329050 | Switch rocker, Impressivo, 1-gang, "bell" symbol, lens, white      | 1/10    |
| 1789KL-81                                    | 6418677329074 | Switch rocker, Impressivo, 1-gang, "bell" symbol, lens, anthracite | 1/10    |
| 1789KL-83                                    | 6418677329081 | Switch rocker, Impressivo, 1-gang, "bell" symbol, lens, aluminum   | 1/10    |
| <b>Design series. Delivery time 3 weeks.</b> |               |  |         |
| 1789KL-866                                   | 4011395086117 | Switch rocker, 1-gang, "bell" symbol, lens, steel                  | 1/10    |
| 1789KI-884                                   | 4011395129357 | Switch rocker, 1-gang, "bell" symbol, lens, white matt             | 1       |
| 1789KI-885                                   | 4011395129791 | Switch rocker, 1-gang, "bell" symbol, lens, black matt             | 1       |



#### Seal for switches, IP44

Seal for 85 mm cover frame. Switches and push switches are IP21 when installed on a rough surface with a seal. Protection class is IP44 when using screw-mounted rocker frame with a seal.

| Type | EAN           | Description                      | Package |
|------|---------------|----------------------------------|---------|
| 2463 | 6418677328176 | Seal for 85 mm cover frame, IP44 | 20/200  |



#### Screw-mounted rocker frames, IP44

Screw-mounted rocker frames are used with the seals 2463 or 2464 to reach IP44 protection class on switches and push switches. Furthermore, it can be used to connect the switch frame to the insert for improved security.

| Type | EAN           | Description   | Package |
|------|---------------|---|---------|
| 2474 | 6418677328190 | Supporting frame for 1/3-gang rocker, screw fastening | 20/200  |
| 2475 | 6418677328206 | Supporting frame for 2-gang rocker, screw fastening   | 20/200  |



**Claws**

Claws for 1-gang socket outlets, Euro socket outlets, switches and push switches. Not suitable for 2-gang Impressivo socket outlet inserts. Inserts with claws are also available.

| Type | EAN           | Description                           | Package |
|------|---------------|---------------------------------------|---------|
| ASE1 | 6410021660932 | Claws for socket outlets and switches | 10/100  |

Signal lights



**Signal light inserts**

LED signal light inserts for 230V supply. Center plates V-81, V-83 and V-84 fit to the inserts. There are screw terminals for max 2,5 mm<sup>2</sup> wires. Not extendable.

| Type           | EAN           | Description  | Package |
|----------------|---------------|--|---------|
| <b>Modular</b> |               |  |         |
| 2661.09        | 6418677334399 | Signal light insert, Led 230 V/25 mA white         | 1/10    |
| 2661.02        | 6418677334382 | Signal light insert, Led 230 V/25 mA red           | 1/10    |
| V-84           | 6418677330100 | Center plate, Signal light, Impressivo, white      | 1/10    |
| V-81           | 6418677330834 | Center plate, Signal light, Impressivo, anthracite | 1/10    |
| V-83           | 6418677330841 | Center plate, Signal light, Impressivo, aluminum   | 1/10    |

**Lamps for switches**

Lamps for switches. Lamps can be installed in 1-gang switch inserts that include the signal-/search light possibility. Lamps can't be installed to 2- or 3-gang switch inserts.



| Type  | EAN           | Description  | Package |
|-------|---------------|--|---------|
| 8370  | 6410021060701 | Lamp, 230 V/0.4 mA, fluorescent, for 1-gang switches | 10/100  |
| 8372  | 6410021060725 | Lamp, 230 V/2 mA, fluorescent, for 1-gang switches   | 10/100  |
| 8375  | 6410021060756 | Lamp, 24 V/22 mA, incandescent, for 1-gang switches  | 10/100  |
| 8376  | 6410021060763 | Lamp, 12 V/40 mA, incandescent, for 1-gang switches  | 10/100  |
| 8331  | 6410021060909 | Lamp, 230 V/1.5 mA, fluorescent, for card switch     | 10/100  |
| 8370R | 6438199004860 | Lamp, 250 V/0.4 mA, LED, for 1-gang switches         | 10/100  |
| 8375R | 6438199004877 | Lamp, 5-24 V/0.5-2.5 mA, LED, for 1-gang switches    | 10/100  |

Socket outlets



**3-gang Euro socket outlets, flush mounting IP21**

Product includes euro socket outlet insert and center plate. The socket outlet insert has shutters and screwless N and L terminals for max 4 wires and 2 screwless X-terminals for max 2 wires. The terminals are for rigid wires.

| Type   | EAN           | Description   | Package |
|--|---------------|---|---------|
| 303UC-84                                     | 6438199001593 | Euro socket outlet, Impressivo, 3-gang, shuttered, screwless terminals, branching terminals, white      | 1/10    |
| 303UC-81                                     | 6438199001579 | Euro socket outlet, Impressivo, 3-gang, shuttered, screwless terminals, branching terminals, anthracite | 1/10    |
| 303UC-83                                     | 6438199001586 | Euro socket outlet, Impressivo, 3-gang, shuttered, screwless terminals, branching terminals, aluminum   | 1/10    |
| <b>Design series. Delivery time 3 weeks.</b> |               |   |         |
| 303UC-866                                    | 6438199004617 | Euro socket outlet, 3-gang, shuttered, screwless terminals, branching terminals, painted steel          | 1/10    |
| 303UC-884                                    | 6438199004624 | Euro socket outlet, 3-gang, shuttered, screwless terminals, branching terminals, white matt             | 1/10    |
| 303UC-885                                    | 6438199004631 | Euro socket outlet, 3-gang, shuttered, screwless terminals, branching terminals, black matt             | 1/10    |



### 2-gang Schuko socket outlets, flush mounting, with cover plate, IP21

Product includes Schuko socket outlet insert and cover plate. The socket outlet insert has shutters and screwless terminals for max 4 rigid wires.

| Type   | EAN           | Description  | Package |
|--|---------------|--|---------|
| 302EUJ-84                                    | 6438199000336 | Socket outlet, Impressivo, Schuko, 2-gang, shuttered, screwless terminals, branching terminals, white      | 1/10    |
| 302EUJ-81                                    | 6438199000343 | Socket outlet, Impressivo, Schuko, 2-gang, shuttered, screwless terminals, branching terminals, anthracite | 1/10    |
| 302EUJ-83                                    | 6438199001531 | Socket outlet, Impressivo, Schuko, 2-gang, shuttered, screwless terminals, branching terminals, aluminum   | 1/10    |
| <b>Design series. Delivery time 3 weeks.</b> |               |  |         |
| 302EUJ-866                                   | 6438199004648 | Socket outlet, Schuko, 2-gang, shuttered, screwless terminals, branching terminals, painted steel          | 1/10    |
| 302EUJ-884                                   | 6438199004655 | Socket outlet, Schuko, 2-gang, shuttered, screwless terminals, branching terminals, white matt             | 1/10    |
| 302EUJ-885                                   | 6438199004662 | Socket outlet, Schuko, 2-gang, shuttered, screwless terminals, branching terminals, black matt             | 1/10    |



### 2-gang Schuko socket outlets, flush mounting in special 1,5 x box, IP21

Product includes Schuko socket outlet insert and cover plate. There are screwless terminals for each contact of the socket outlet for max 4 rigid wires. No X-terminals. The socket outlet insert has shutters. Flush mounting on a smooth surface IP21. Very flat construction. Installation in special 1,5X mounting box.

| Type        | EAN           | Description  | Package |
|-------------|---------------|--|---------|
| 302EUJT-84  | 6438199003665 | Socket outlet, Schuko, 2-gang, shuttered, screwless terminals, branching terminals, flat, white      | 1/10    |
| 302EUJT-81  | 6438199003641 | Socket outlet, Schuko, 2-gang, shuttered, screwless terminals, branching terminals, flat, anthracite | 1/10    |
| 302EUJT-83  | 6438199003658 | Socket outlet, Schuko, 2-gang, shuttered, screwless terminals, branching terminals, flat, aluminum   | 1/10    |
| 302EUJT-885 | 6438199005348 | Socket outlet, Schuko, 2-gang, shuttered, screwless terminals, branching terminals, flat, matt black | 1/10    |



### 2-gang Schuko socket outlets, flush mounting, IP21

Product includes Schuko socket outlet insert and center plate. The socket outlet insert has shutters and screwless terminals for max 4 rigid wires.

| Type      | EAN           | Description   | Package |
|-----------|---------------|---|---------|
| 302EUC-84 | 6438199001524 | Schuko socket outlet, Impressivo, 2-gang, shuttered, screwless terminals, branching terminals, white      | 1/10    |
| 302EUC-81 | 6438199001500 | Schuko socket outlet, Impressivo, 2-gang, shuttered, screwless terminals, branching terminals, anthracite | 1/10    |
| 302EUC-83 | 6438199001517 | Schuko socket outlet, Impressivo, 2-gang, shuttered, screwless terminals, branching terminals, aluminum   | 1/10    |



### 2-gang Schuko outlets with special colour, IP21

Product includes Schuko socket outlet insert and center plate. The socket outlet insert has shutters and screwless terminals for max 4 rigid wires. These socket outlets can be used, for instance, in hospitals and offices, when there is a need to limit socket outlet use to certain applications. Flush mounting: On a smooth surface IP21, on a rough surface with a seal IP21. Surface mounting: IP21.

| Type      | EAN           | Description   | Package |
|-----------|---------------|---|---------|
| 302EUC-02 | 6438199004686 | Schuko socket outlet, Impressivo, 2-gang, shuttered, screwless terminals, branching terminals, red    | 1/10    |
| 302EUC-03 | 6438199004693 | Schuko socket outlet, Impressivo, 2-gang, shuttered, screwless terminals, branching terminals, orange | 1/10    |
| 302EUC-05 | 6438199004709 | Schuko socket outlet, Impressivo, 2-gang, shuttered, screwless terminals, branching terminals, green  | 1/10    |
| 302EUC-06 | 6438199004716 | Schuko socket outlet, Impressivo, 2-gang, shuttered, screwless terminals, branching terminals, blue   | 1/10    |





**Flush mounting 2-gang Schuko socket outlets with lid IP21**

Product includes Schuko socket outlet insert, center plate with lid. The socket outlet insert has shutters and screwless terminals. The terminals are for max 2 rigid wires. Flush mounting on slide surface IP21 and with seal 2464 on rough surface IP44. The seal 2464 is not included in delivery.

| Type       | EAN           | Description  | Package |
|------------|---------------|--|---------|
| 302EUCK-84 | 6438199004792 | Schuko socket outlet, Impressivo, 2-gang with lid, shuttered, screwless terminals, branching terminals, white      | 1/10    |
| 302EUCK-81 | 6438199004778 | Schuko socket outlet, Impressivo, 2-gang with lid, shuttered, screwless terminals, branching terminals, anthracite | 1/10    |
| 302EUCK-83 | 6438199004785 | Schuko socket outlet, Impressivo, 2-gang with lid, shuttered, screwless terminals, branching terminals, aluminium  | 1/10    |



**Non-earthed flush mounting 2-gang socket outlets IP21, with cover plate**

Product includes socket outlet insert, center plate and cover frame. The socket outlet insert has shutters and screwless terminals for max 4 rigid wires. Claws can be fitted to socket outlet afterwards.

| Type     | EAN           | Description   | Package |
|----------|---------------|---|---------|
| 302UJ-84 | 6438199001562 | Socket outlet, Impressivo, not earthed, 2-gang, shuttered, screwless terminals, branching terminals, white      | 1/10    |
| 302UJ-81 | 6438199001548 | Socket outlet, Impressivo, not earthed, 2-gang, shuttered, screwless terminals, branching terminals, anthracite | 1/10    |
| 302UJ-83 | 6438199001555 | Socket outlet, Impressivo, not earthed, 2-gang, shuttered, screwless terminals, branching terminals, aluminum   | 1/10    |



**Flush mounting 2-gang Schuko socket outlets IP21 with cover plate**

Product includes Schuko socket outlet insert, center plate and cover frame. The socket outlet has shutters and screwless terminals for max 2 rigid wires.

| Type      | EAN           | Description   | Package |
|-----------|---------------|---|---------|
| 20EUIJ-84 | 6438199000572 | Socket outlet, Impressivo, Schuko, 1-gang, shuttered, screwless terminals, white      | 1/10    |
| 20EUIJ-81 | 6438199001487 | Socket outlet, Impressivo, Schuko, 1-gang, shuttered, screwless terminals, anthracite | 1/10    |
| 20EUIJ-83 | 6438199001494 | Socket outlet, Impressivo, Schuko, 1-gang, shuttered, screwless terminals, aluminum   | 1/10    |



**1-gang Schuko socket outlets, flush mounting, IP21**

Product includes Schuko socket outlet insert and center plate. The socket outlet has shutters and screwless terminals for max 2 rigid wires.

| Type     | EAN           | Description   | Package |
|----------|---------------|---|---------|
| 20EUC-84 | 6438199000510 | Socket outlet, Impressivo, Schuko, 1-gang, shuttered, screwless terminals, white      | 1/10    |
| 20EUC-81 | 6438199001449 | Socket outlet, Impressivo, Schuko, 1-gang, shuttered, screwless terminals, anthracite | 1/10    |
| 20EUC-83 | 6438199001456 | Socket outlet, Impressivo, Schuko, 1-gang, shuttered, screwless terminals, aluminum   | 1/10    |

**Design series. Delivery time 3 weeks.**

|             |               |  |      |
|-------------|---------------|--|------|
| 20EUCKS-866 | 4011395087534 | Socket outlet schuko, 16A/250V, 1-gang, steel      | 10   |
| 20EUCKS-884 | 4011395129913 | Socket outlet schuko, 16A/250V, 1-gang, white matt | 1/10 |
| 20EUCKS-885 | 4011395130049 | Socket outlet schuko, 16A/250V, 1-gang, black matt | 1/10 |



**Flush mounting 1-gang Schuko socket outlets with lid IP21**

Product includes Schuko socket outlet insert and center plate. The socket outlet has shutters and screwless terminals for max 2 rigid wires.

| Type      | EAN           | Description  | Package |
|-----------|---------------|--|---------|
| 20EUCK-84 | 6438199000527 | Socket outlet, Impressivo, Schuko, 1-gang, screwless terminals, white      | 1/10    |
| 20EUCK-81 | 6438199001463 | Socket outlet, Impressivo, Schuko, 1-gang, screwless terminals, anthracite | 1/10    |
| 20EUCK-83 | 6438199001470 | Socket outlet, Impressivo, Schuko, 1-gang, screwless terminals, aluminum   | 1/10    |



#### 1-gang Schuko socket outlets, flush mounting, with LED light, IP20

Product includes Schuko socket outlet insert and center plate. A white color LED light is integrated into the socket outlet. The light can be controlled separately or it can be connected to the socket terminals. The socket outlet insert has shutters. There are screwless terminals for max 2 rigid wires for each contact of the socket outlet.

| Type   | EAN           | Description  | Package |
|--|---------------|--|---------|
| 20EUCBLI-84                                  | 4011395100769 | Socket outlet, Impressivo, Schuko, 1-gang, shuttered, screwless terminals, LED light, white    | 1/10    |
| 20EUCBLI-83                                  | 4011395100752 | Socket outlet, Impressivo, Schuko, 1-gang, shuttered, screwless terminals, LED light, aluminum | 1/10    |
| <b>Design series. Delivery time 3 weeks.</b> |               |  |         |
| 20EUCBLI-884                                 | 4011395129883 | Socket outlet, Schuko, 1-gang, shuttered, screwless terminals, LED light, matt white           | 1       |
| 20EUCBLI-885                                 | 4011395130025 | Socket outlet, Schuko, 1-gang, shuttered, screwless terminals, LED light, matt black           | 1       |



#### 1-gang Schuko socket outlet with center plate and USB charger, IP20

The socket outlet has an integrated USB charger 5 V/0.7 A with electronic short-circuit and overload protection. Power dissipation 0.1 W. Compatible with USB devices, iPod and iPhone. The Schuko socket outlet is 16 A/250 V. There are screwless terminals for each contact of the socket outlet. The socket outlet has shutters. The terminals are for max 2 rigid wires. No X-terminals.

| Type   | EAN           | Description  | Package |
|--|---------------|--|---------|
| 20EUCBUSB-84                                 | 4011395164570 | 1-gang socket outlet and USB charger, Impressivo white, shuttered Schuko, screwless terminals      | 1       |
| 20EUCBUSB-81                                 | 4011395164549 | 1-gang socket outlet and USB charger, Impressivo anthracite, shuttered Schuko, screwless terminals | 1       |
| 20EUCBUSB-83                                 | 4011395164563 | 1-gang Socket outlet and USB charger, Impressivo aluminum, shuttered Schuko, screwless terminals   | 1       |
| <b>Design series. Delivery time 3 weeks.</b> |               |  |         |
| 20EUCBUSB-884                                | 4011395164617 | Socket outlet, Schuko, 1-g, shuttered, screwless terminals, with USB charger, matt white           | 1       |
| 20EUCBUSB-885                                | 4011395164624 | Socket outlet, Schuko, 1-g, shuttered, screwless terminals, with USB charger, matt black           | 1       |



#### Residual current devices

16 A/250 V IP21, with built-in A-type residual current device (RCD), tripping current 30 mA. Approved for extending a branch circuit, but only regular sockets connected to protected outlet wires are protected. The socket outlet insert has shutters. The products are sold with cover plates. The socket outlet insert has shutters and screwless terminals.

| Type        | EAN           | Description   | Package |
|-------------|---------------|---|---------|
| 3120EUC-84  | 7612271472283 | Socket residual current device with a rated current of 16 A and s rated residual current of 30mA. | 1/10    |
| 3150UC-84.1 | 7612271473808 | Residual current device with a rated current of 16 A and s rated residual current of 30mA.        | 1/10    |



#### 2-gang Schuko socket outlet, Flush mounting, IP44

Product includes Schuko socket outlet insert, center plate with lid, cover frame and seal. The socket outlet insert has shutters and screwless terminals. The terminals are for max 2 rigid wires. Flush mounting on rough surface IP44.

| Type       | EAN           | Description   | Package |
|------------|---------------|---|---------|
| 302EUJW-84 | 6438199000046 | Socket outlet, Impressivo, Schuko, 2-gang, shuttered, screwless terminals, branching terminals, white, IP44 | 1/10    |



#### 1-gang Schuko socket outlet, flush mounting, IP44

Product includes Schuko socket outlet insert, center plate with lid, cover frame and seal. The socket outlet insert has shutters and screwless terminals. The terminals are for max 2 rigid wires. Flush mounting on rough surface IP44.

| Type      | EAN           | Description  | Package |
|-----------|---------------|--|---------|
| 20EUJW-84 | 6438199000015 | Socket outlet, Impressivo, Schuko, 1-gang, shuttered, screwless terminals, white, IP44 | 1/10    |



**Seal for 2-gang socket outlet, IP44**

2-gang socket outlets installed with a seal and a center plate with a hinged lid are IP44. Socket outlet without hinged lid on a rough surface is IP21.

| Type | EAN           | Description                       | Package |
|------|---------------|-----------------------------------|---------|
| 2464 | 6418677328183 | Seal for 100 mm cover frame, IP44 | 20/200  |



**Seal for 1-gang socket outlet, IP44**

1-gang socket outlets installed with a seal and a center plate with a hinged lid are IP44. Socket outlet without hinged lid on a rough surface is IP21.

| Type | EAN           | Description                      | Package |
|------|---------------|----------------------------------|---------|
| 2463 | 6418677328176 | Seal for 85 mm cover frame, IP44 | 20/200  |



**Claws**

Claws for 1-gang socket outlets, Euro socket outlets, switches and push switches. Not suitable for 2-gang Impressivo socket outlet inserts. Inserts with claws are also available.

| Type | EAN           | Description                           | Package |
|------|---------------|---------------------------------------|---------|
| ASE1 | 6410021660932 | Claws for socket outlets and switches | 10/100  |

Tele and data



**RJ45 outlet with sliding dust covers for Impressivo**

Insert for 2 x RJ45 connectors and center plate with dust covers. The connectors CEL30.UX are not compatible with this device, due to its integrated blind covers.

| Type           | EAN           | Description   | Package |
|----------------|---------------|---|---------|
| <b>Modular</b> |               |   |         |
| 1819.01        | 6418677330445 | Supporting frame insert for 2 x RJ45, Keystone              | 10/100  |
| 1819.02        | 6418677330452 | Supporting frame insert for 2 x RJ45, AMP                   | 10/100  |
| 1819.03        | 6418677330469 | Supporting frame insert for 2 x RJ45, Actassi               | 10/100  |
| 1819.04        | 6418677335945 | Supporting frame insert for 2 x RJ45, Systimax              | 10/100  |
| 1819DC-84      | 6438199002835 | Center plate, Impressivo, 2 x RJ45, dust covers, white      | 1/10    |
| 1819DC-81      | 6438199002811 | Center plate, Impressivo, 2 x RJ45, dust covers, anthracite | 1/10    |
| 1819DC-83      | 6438199002828 | Center plate, Impressivo, 2 x RJ45, dust covers, aluminum   | 1/10    |



**RJ45 outlet with sliding dust covers for design-series**

Insert for 2 x RJ45 connectors and center plate with dust covers. The connectors CEL30.UX are not compatible with this device, due to its integrated blind covers.

| Type   | EAN           | Description   | Package |
|--|---------------|---|---------|
| <b>Modular</b>                               |               |   |         |
| 1810.1                                       | 6410072040639 | Supporting frame insert for 2 x RJ45, green, Systimax | 10/100  |
| 1812.1                                       | 6410072040837 | Supporting frame insert for 2 x RJ45, red, Keystone   | 10/100  |
| 1814.1                                       | 6410072040851 | Supporting frame insert for 2 x RJ45, black, AMP      | 10/100  |
| <b>Design series. Delivery time 3 weeks.</b> |               |   |         |
| 1800-866                                     | 4011395087923 | Center plate, 2 x RJ45, dust covers, steel            | 1/10    |
| 1800-884                                     | 4011395127087 | Center plate, 2 x RJ45, dust covers, white matt       | 1       |
| 1800-885                                     | 4011395127346 | Center plate, 2 x RJ45, dust covers, black matt       | 1       |



#### RJ45 outlet including connectors

RJ45 outlet including 2 x Cat6 UTP RJ45 connectors manufactured by 3M and blind cover plates. The dust covers are integrated in the connector. Blind covers included.

| Type       | EAN           | Description   | Package |
|------------|---------------|---|---------|
| FOT6208-84 | 6438199001715 | Tele outlet, Impressivo, 2 x RJ45, Cat6 UTP, white            | 1/10    |
| FOT6208-81 | 6438199001692 | Tele outlet, Impressivo, 2 x black RJ45, Cat6 UTP, anthracite | 1/10    |
| FOT6208-83 | 6438199001708 | Tele outlet, Impressivo, 2 x RJ45, Cat6 UTP, aluminum         | 1/10    |



#### RJ45 connectors

Unshielded (UTP) RJ45 connectors with Keystone fixing and A/B coupling. No special connecting tool is needed. Use with RJ45 insert 1819.01 and center plate 1819-xx. The dust covers are integrated into the connectors. The connector is manufactured by 3M.

| Type     | EAN           | Description                       | Package |
|----------|---------------|-----------------------------------|---------|
| CEL30.U6 | 6418677326486 | Connector, RJ45, Cat6, UTP, white | 10/100  |



#### DKS insert and center plate

DKS-center plate is used to fix many different kind of tele connectors into the mounting box. To be fitted with a suitable DKS adapter 18XXEB.XXX. The product includes center plate and assembly ring.

| Type    | EAN           | Description  | Package |
|---------|---------------|--|---------|
| 1758-84 | 6418677329371 | DKS center plate, Impressivo, DKS-system, white      | 1/10    |
| 1758-81 | 6418677329395 | DKS center plate, Impressivo, DKS-system, anthracite | 1/10    |
| 1758-83 | 6418677329401 | DKS center plate, Impressivo, DKS-system, aluminum   | 1/10    |

#### Design series. Delivery time 3 weeks.

|          |               |  |      |
|----------|---------------|--|------|
| 1758-866 | 4011395087992 | Tele outlet, DKS-system, painted steel | 1/10 |
| 1758-884 | 4011395131596 | Tele outlet, DKS-system, white matt    | 1    |
| 1758-885 | 4011395128718 | Tele outlet, DKS-system, black matt    | 1    |



#### DKS-adapter with VGA connector

Suitable for DKS-center plate 1758-xx. VGA connector is included (15pin D-sub). Cable should be connected by soldering.

| Type       | EAN           | Description   | Package |
|------------|---------------|---|---------|
| 1850EB.VGA | 6418677334375 | Tele outlet for DKS-system with VGA display connector | 1/10    |



#### DKS-adapter with Composite-/S-video connectors

Suitable for DKS-center plate 1758-xx. Composite (BNC) and S-video (Mini DIN) connectors are included. Composite video connectors internal coaxial cable should be terminated by BNC-type connector. S-video internal cable is standard twisted-pair cable with toolless connection.

| Type       | EAN           | Description  | Package |
|------------|---------------|--|---------|
| 1875EB.YCV | 6418677334351 | Tele outlet for DKS-system with Composite-video and S-video connectors | 1/10    |



#### DKS-adapter with Speakon connector

Suitable for DKS-center plate 1758-xx. Speakon 4-pin loudspeaker connector is included. Flat tab terminals.

| Type       | EAN           | Description   | Package |
|------------|---------------|---|---------|
| 1876EB.SPE | 6418677334368 | Tele outlet for DKS-system with Speakon audio connector | 1/10    |



**DKS-adapters**

Different adapters for DKS-system. Suitable for DKS-center plate 1758-xx.

| Type          | EAN           | Description   | Package |
|---------------|---------------|---|---------|
| <b>RJ45</b>   |               |   |         |
| 1867EB        | 4011395182802 | Adapter for DKS-system, 2 x RJ45, Keystone                    | 10/100  |
| 1875EB        | 4011395776902 | Adapter for DKS-system, 2 x RJ45, AMP                         | 10/100  |
| 1872EB        | 4011395540800 | Adapter for DKS-system, 2 x RJ45, Systimax                    | 10/100  |
| <b>Fiber</b>  |               |   |         |
| 1870EB        | 4011395454107 | Adapter for DKS-system, fiber 2 x Simplex ST                  | 10/100  |
| 1874EB        | 4011395734902 | Adapter for DKS-system, fiber 2 x SCD                         | 10/100  |
| <b>Audio</b>  |               |   |         |
| 1853EB        | 4011395181409 | Adapter for DKS-system, XLR audio connector type FP           | 10/100  |
| 1854EB        | 4011395181508 | Adapter for DKS-system, XLR audio connector type MP           | 10/100  |
| 1876EB        | 4011395022566 | Adapter for DKS-system, XLR D-type or Speakon audio connector | 10/100  |
| <b>Others</b> |               |   |         |
| 1850EB        | 6438100605308 | Adapter for DKS-system, D-type 9-pin connector                | 10/100  |
| 1855EB        | 4011395181607 | Adapter for DKS-system, 2 x BNC/TNC, 9,8 mm                   | 10/100  |
| 1857EB        | 6418677329975 | Adapter for DKS-system, 2 x BNC/TNC, 12,9 mm                  | 10/100  |
| 1869EB        | 4011395183007 | Adapter for DKS-system, blank                                 | 10/100  |

**Antenna center plate**

Center plate for common antenna outlet inserts. The terminal "Sat" is closed, but can be knocked out.



| Type   | EAN           | Description                                    | Package |
|--|---------------|--|---------|
| 1743-84                                      | 6418677329418 | Center plate, Impressivo, TV/R/Sat, white      | 1/10    |
| 1743-81                                      | 6418677329432 | Center plate, Impressivo, TV/R/Sat, anthracite | 1/10    |
| 1743-83                                      | 6418677329449 | Center plate, Impressivo, TV/R/Sat, aluminum   | 1/10    |
| <b>Design series. Delivery time 3 weeks.</b> |               |  |         |
| 1743-866                                     | 4011395087893 | Center plate, TV/R/Sat, steel                  | 1/10    |
| 1743-884                                     | 4011395128626 | Center plate, TV/R/Sat, white matt             | 1       |
| 1743-885                                     | 4011395128695 | Center plate, TV/R/Sat, black matt             | 1       |

**USB charger**

For supply and support of two mobile devices via USB-cable. With two USB A-type connectors. With electronic short-circuit and overload protection. Rated voltage: 230 V~/5 V-, 50 Hz - 60 Hz, power dissipation 0.3W. Suitable for: In case one output is used rated current max 1400 mA. In case two output are used rated current max 700 mA.



| Type   | EAN           | Description  | Package |
|--|---------------|--|---------|
| <b>Insert</b>                                |               |  |         |
| 6472U  | 4011395151594 | Tele outlet insert, USB charging station 2 x 0.7 A | 1       |
| <b>Center plate</b>                          |               |  |         |
| 1766-84                                      | 6418677331305 | Center plate, Impressivo, tele outlet, white       | 1/10    |
| 1766-81                                      | 6418677331329 | Center plate, Impressivo, tele outlet, anthracite  | 1/10    |
| 1766-83                                      | 6418677331336 | Center plate, Impressivo, tele outlet, aluminum    | 1/10    |
| <b>Design series. Delivery time 3 weeks.</b> |               |  |         |
| 1766-866                                     | 4011395087848 | Center plate, tele outlet, steel                   | 1/10    |
| 1766-884                                     | 4011395131626 | Center plate, tele outlet, white matt              | 1       |
| 1766-885                                     | 4011395127261 | Center plate, tele outlet, black matt              | 1       |

**Tele outlet USB**

Tele outlet with USB A-type connector. Compatible up to USB 2.0 versions. Internal connections with screw type terminals.

| Type   | EAN           | Description                                       | Package |
|--|---------------|---|---------|
| <b>Insert: Delivery time 3 weeks</b>         |               |   |         |
| 0261/13                                      | 4011395167557 | Tele outlet insert, with USB A-type connector     | 1       |
| <b>Center plate</b>                          |               |   |         |
| 1766-84                                      | 6418677331305 | Center plate, Impressivo, tele outlet, white      | 1/10    |
| 1766-81                                      | 6418677331329 | Center plate, Impressivo, tele outlet, anthracite | 1/10    |
| 1766-83                                      | 6418677331336 | Center plate, Impressivo, tele outlet, aluminum   | 1/10    |
| <b>Design series. Delivery time 3 weeks.</b> |               |   |         |
| 1766-866                                     | 4011395087848 | Center plate, tele outlet, steel                  | 1/10    |
| 1766-884                                     | 4011395131626 | Center plate, tele outlet, white matt             | 1       |
| 1766-885                                     | 4011395127261 | Center plate, tele outlet, black matt             | 1       |

**Tele outlet VGA**

Tele outlet for VGA display with D-sub 15pin connector. Internal connections with screw type terminals.

| Type   | EAN           | Description  | Package |
|--|---------------|--|---------|
| <b>Insert: Delivery time 3 weeks</b>         |               |  |         |
| 0261/23                                      | 4011395167618 | Tele outlet insert, with VGA 15pin D-sub connector | 1       |
| <b>Center plate</b>                          |               |  |         |
| 1766-84                                      | 6418677331305 | Center plate, Impressivo, tele outlet, white       | 1/10    |
| 1766-81                                      | 6418677331329 | Center plate, Impressivo, tele outlet, anthracite  | 1/10    |
| 1766-83                                      | 6418677331336 | Center plate, Impressivo, tele outlet, aluminum    | 1/10    |
| <b>Design series. Delivery time 3 weeks.</b> |               |  |         |
| 1766-866                                     | 4011395087848 | Center plate, tele outlet, steel                   | 1/10    |
| 1766-884                                     | 4011395131626 | Center plate, tele outlet, white matt              | 1       |
| 1766-885                                     | 4011395127261 | Center plate, tele outlet, black matt              | 1       |

**Tele outlet HDMI**

Tele outlet for HDMI display with A-type connector. Internal connections with screw type terminals.

| Type   | EAN           | Description                                       | Package |
|--|---------------|---|---------|
| <b>Insert: Delivery time 3 weeks</b>         |               |   |         |
| 0261/33                                      | 4011395167670 | Tele outlet insert, with HDMI A-type connector    | 1       |
| <b>Center plate</b>                          |               |   |         |
| 1766-84                                      | 6418677331305 | Center plate, Impressivo, tele outlet, white      | 1/10    |
| 1766-81                                      | 6418677331329 | Center plate, Impressivo, tele outlet, anthracite | 1/10    |
| 1766-83                                      | 6418677331336 | Center plate, Impressivo, tele outlet, aluminum   | 1/10    |
| <b>Design series. Delivery time 3 weeks.</b> |               |   |         |
| 1766-866                                     | 4011395087848 | Center plate, tele outlet, steel                  | 1/10    |
| 1766-884                                     | 4011395131626 | Center plate, tele outlet, white matt             | 1       |
| 1766-885                                     | 4011395127261 | Center plate, tele outlet, black matt             | 1       |



**Tele outlet BNC-F**

Tele outlet for 1 or 2 BNC-F type connectors. Mounting hole for a connector is 12 mm. The insert and the connectors are sold separately.

| Type   | EAN           | Description                                       | Package |
|--|---------------|---|---------|
| <b>Insert and connector: Delivery time 3 weeks</b> |               |   |         |
| 0262/13  | 4011395167731 | Tele outlet insert for 2 x BNC-F type connectors  | 1       |
| 0262   | 4011395167748 | Connector, BNC-F type, d = 12 mm                  | 1       |
| <b>Center plate</b>                                |               |   |         |
| 1766-84  | 6418677331305 | Center plate, Impressivo, tele outlet, white      | 1/10    |
| 1766-81  | 6418677331329 | Center plate, Impressivo, tele outlet, anthracite | 1/10    |
| 1766-83  | 6418677331336 | Center plate, Impressivo, tele outlet, aluminum   | 1/10    |
| <b>Design series. Delivery time 3 weeks.</b>       |               |   |         |
| 1766-866   | 4011395087848 | Center plate, tele outlet, steel                  | 1/10    |
| 1766-884   | 4011395131626 | Center plate, tele outlet, white matt             | 1       |
| 1766-885   | 4011395127261 | Center plate, tele outlet, black matt             | 1       |



**Tele outlet RCA**

Tele outlet for 1 or 2 RCA audio/video connectors. The insert and the connectors are sold separately.

| Type  | EAN           | Description                                       | Package |
|---|---------------|---|---------|
| <b>Insert and connectors: Delivery time 3 weeks</b> |               |   |         |
| 0263/13   | 4011395167816 | Tele outlet insert for 2 x RCA connectors         | 1       |
| 0263/04   | 4011395167861 | Connector, RCA white                              | 1       |
| 0263/05   | 4011395167878 | Connector, RCA black                              | 1       |
| 0263/06   | 4011395167885 | Connector, RCA red                                | 1       |
| 0263/07   | 4011395167892 | Connector, RCA yellow                             | 1       |
| <b>Center plate</b>                                 |               |   |         |
| 1766-84   | 6418677331305 | Center plate, Impressivo, tele outlet, white      | 1/10    |
| 1766-81   | 6418677331329 | Center plate, Impressivo, tele outlet, anthracite | 1/10    |
| 1766-83   | 6418677331336 | Center plate, Impressivo, tele outlet, aluminum   | 1/10    |
| <b>Design series. Delivery time 3 weeks.</b>        |               |   |         |
| 1766-866  | 4011395087848 | Center plate, tele outlet, steel                  | 1/10    |
| 1766-884  | 4011395131626 | Center plate, tele outlet, white matt             | 1       |
| 1766-885  | 4011395127261 | Center plate, tele outlet, black matt             | 1       |



**Tele outlet for Mini Jack**

Tele outlet for 1 or 2 Mini Jack connectors. The insert and the connectors are sold separately.

| Type   | EAN           | Description                                       | Package |
|--|---------------|---|---------|
| <b>Insert and connector: Delivery time 3 weeks</b> |               |   |         |
| 0264/13  | 4011395167953 | Tele outlet insert for 2 x Mini Jack connectors   | 1       |
| 0264   | 4011395167960 | Connector, Mini Jack 3,5 mm, stereo               | 1       |
| <b>Center plate</b>                                |               |   |         |
| 1766-84  | 6418677331305 | Center plate, Impressivo, tele outlet, white      | 1/10    |
| 1766-81  | 6418677331329 | Center plate, Impressivo, tele outlet, anthracite | 1/10    |
| 1766-83  | 6418677331336 | Center plate, Impressivo, tele outlet, aluminum   | 1/10    |
| <b>Design series. Delivery time 3 weeks.</b>       |               |   |         |
| 1766-866   | 4011395087848 | Center plate, tele outlet, steel                  | 1/10    |
| 1766-884   | 4011395131626 | Center plate, tele outlet, white matt             | 1       |
| 1766-885   | 4011395127261 | Center plate, tele outlet, black matt             | 1       |

**Speaker outlet, stereo**

There are plug in connectors for speaker wires and screw terminals for max 10 mm<sup>2</sup> internal wires.

| Type   | EAN           | Description                                       | Package |
|--|---------------|---|---------|
| <b>Modular</b>                               |               |   |         |
| 0248.00                                      | 6418677331367 | Tele outlet insert, speaker, stereo               | 1/10    |
| 1766-84                                      | 6418677331305 | Center plate, Impressivo, tele outlet, white      | 1/10    |
| 1766-81                                      | 6418677331329 | Center plate, Impressivo, tele outlet, anthracite | 1/10    |
| 1766-83                                      | 6418677331336 | Center plate, Impressivo, tele outlet, aluminum   | 1/10    |
| <b>Design series. Delivery time 3 weeks.</b> |               |   |         |
| 1766-866                                     | 4011395087848 | Center plate, tele outlet, steel                  | 1/10    |
| 1766-884                                     | 4011395131626 | Center plate, tele outlet, white matt             | 1       |
| 1766-885                                     | 4011395127261 | Center plate, tele outlet, black matt             | 1       |

**Speaker outlet, mono**

There is one red and one black gold plated terminal screw for the speaker wires and screw terminals for max 10 mm<sup>2</sup> internal wires.

| Type           | EAN           | Description  | Package |
|----------------|---------------|--|---------|
| <b>Modular</b> |               |  |         |
| 1819.LSP       | 6418677334337 | Speaker insert, with terminal screws                         | 1/10    |
| 1819-84        | 6418677330476 | Center plate, Impressivo, 2 x RJ45, blind covers, white      | 1/10    |
| 1819-81        | 6418677330490 | Center plate, Impressivo, 2 x RJ45, blind covers, anthracite | 1/10    |
| 1819-83        | 6418677330506 | Center plate, Impressivo, 2 x RJ45, blind covers, aluminum   | 1/10    |

**Center plates for Ø 22,5 mm devices**

Center plates with Ø 22,5 mm openings, equipped with a groove to prevent rotation. Use with 22 mm diameter to fasten different devices.

| Type   | EAN           | Description                                       | Package |
|--|---------------|---|---------|
| 2533-84                                      | 6418677329456 | Tele outlet, Impressivo, 22,5 mm hole, white      | 1/10    |
| 2533-81                                      | 6418677329470 | Tele outlet, Impressivo, 22,5 mm hole, anthracite | 1/10    |
| 2533-83                                      | 6418677329487 | Tele outlet, Impressivo, 22,5 mm hole, aluminum   | 1/10    |
| <b>Design series. Delivery time 3 weeks.</b> |               |   |         |
| 2533-866                                     | 4011395087244 | Tele outlet, 22,5 mm hole, painted steel          | 1/10    |
| 2533-884                                     | 4011395128671 | Tele outlet, 22,5 mm hole, white matt             | 1       |
| 2533-885                                     | 4011395128756 | Tele outlet, 22,5 mm hole, black matt             | 1       |

**Equipotential outlet**

2-gang equipotential outlet. Screw terminals for 1 x 6 mm<sup>2</sup> and 4 x 2,5 mm<sup>2</sup> wires. The product includes insert and center plate.

| Type      | EAN           | Description  | Package |
|-----------|---------------|--|---------|
| 2095UC-84 | 6418677330513 | Equipotential outlet, Impressivo, 2-gang, white      | 10/100  |
| 2095UC-81 | 6418677330537 | Equipotential outlet, Impressivo, 2-gang, anthracite | 10/100  |
| 2095UC-83 | 6418677330544 | Equipotential outlet, Impressivo, 2-gang, aluminum   | 10/100  |

**Equipotential plug**

Suitable for potential equalization and to be used with equipotential outlets. For max. 6 mm<sup>2</sup> wires. The wire is connected by pressing with tool or by soldering.

| Type       | EAN           | Description                     | Package |
|------------|---------------|---------------------------------|---------|
| 0299.00032 | 6410070602921 | Plug for potential compensation | 10/100  |



## Accessories

### IP44 sealing



#### Screw-mounted rocker frames, IP44

Screw-mounted rocker frame is used with the seals 2463 or 2464 to reach IP44 protection class on switches and push switches. Furthermore, it can be used to connect the switch frame to the insert with screws for improved security.

| Type | EAN           | Description   | Package |
|------|---------------|---|---------|
| 2474 | 6418677328190 | Supporting frame for 1/3-gang rocker, screw fastening | 20/200  |
| 2475 | 6418677328206 | Supporting frame for 2-gang rocker, screw fastening   | 20/200  |



#### Seal 85 mm, IP44

1-gang socket outlet inserts installed with the seal and a center plate with hinged lid are IP44. Switches and push buttons installed with the seal and with the screwmounted rocker frames are IP44.

| Type | EAN           | Description                      | Package |
|------|---------------|----------------------------------|---------|
| 2463 | 6418677328176 | Seal for 85 mm cover frame, IP44 | 20/200  |



#### Seal 100 mm, IP44

2-gang socket outlet inserts installed with the seal and a center plate with hinged lids are IP44. Switches, push buttons and 1-gang socket outlets with a hinged lid are also IP44, when using the seal with adaptor 2519-xx. Screw mounted rocker frame must be used to reach IP44 protection class.

| Type | EAN           | Description                       | Package |
|------|---------------|-----------------------------------|---------|
| 2464 | 6418677328183 | Seal for 100 mm cover frame, IP44 | 20/200  |

## Accessories



#### Blind center plate, 85 mm

85 mm blind center plate can be used to cover an empty box. It can be used together with 85 mm flush- and surface mounting frames. Flush mounting: On a smooth surface IP21, on a rough surface IP20 (seal can't be used). When installed on surface with 2456.26 and 172xS85-xx, protection class is IP44.

| Type     | EAN           | Description                                 | Package |
|----------|---------------|---|---------|
| 2538-84  | 6418677330551 | Center plate, Impressivo, blind, white      | 1/10    |
| 2538-81  | 6418677330575 | Center plate, Impressivo, blind, anthracite | 1/10    |
| 2538-83  | 6418677330582 | Center plate, Impressivo, blind, aluminum   | 1/10    |
| 1742-866 | 4011395086742 | Center plate, blind, steel                  | 1/10    |
| 1742-884 | 4011395126936 | Center plate, blind, white matt             | 1       |
| 1742-885 | 4011395127179 | Center plate, blind, black matt             | 1       |



#### Blind center plate, 100 mm

100 mm blind center plate can be used to cover an empty box. Can be used together with 100 mm flush- and surface mounting frames. Flush mounting: On a smooth surface IP21, on a rough surface IP20 (seal can't be used). When installed on surface the protection class is IP44 if wires are installed downwards.

| Type        | EAN           | Description   | Package |
|-------------|---------------|---|---------|
| 2538-100-84 | 6418677332319 | Center plate, Impressivo, 100 mm, blind, white      | 1/10    |
| 2538-100-81 | 6418677332296 | Center plate, Impressivo, 100 mm, blind, anthracite | 1/10    |
| 2538-100-83 | 6418677332302 | Center plate, Impressivo, 100 mm, blind, aluminum   | 1/10    |

**Adapter 85/100 mm, IP21/IP44**

1-gang center plated accessories can be mounted in 100 mm cover frames with the adapter. Final IP class of installation is defined by the accessories.

| Type    | EAN           | Description                                | Package |
|---------|---------------|--|---------|
| 2519-84 | 6418677328213 | Adapter, Impressivo, 85/100 mm, white      | 1/20    |
| 2519-81 | 6418677328237 | Adapter, Impressivo, 85/100 mm, anthracite | 1/20    |
| 2519-83 | 6418677328244 | Adapter, Impressivo, 85/100 mm, aluminum   | 1/20    |

**Labeling plate**

Labeling plate for Jussi and Impressivo cover frames. Size of text area is max 12 x 52 mm.

| Type | EAN           | Description   | Package |
|------|---------------|---|---------|
| 2752 | 6438199000848 | Labeling plate for Jussi and Impressivo cover plates. | 10/100  |

**Lamps for switches**

Lamps for switches and push buttons. Lamps can be installed in 1-gang switch inserts that include the signal-/ search light possibility. Lamps can't be installed in 2- or 3-gang switch inserts.

| Type  | EAN           | Description  | Package |
|-------|---------------|--|---------|
| 8370  | 6410021060701 | Lamp, 230 V/0.4 mA, fluorescent, for 1-gang switches | 10/100  |
| 8372  | 6410021060725 | Lamp, 230 V/2 mA, fluorescent, for 1-gang switches   | 10/100  |
| 8375  | 6410021060756 | Lamp, 24 V/22 mA, incandescent, for 1-gang switches  | 10/100  |
| 8376  | 6410021060763 | Lamp, 12V/40 mA, incandescent, for 1-gang switches   | 10/100  |
| 8331  | 6410021060909 | Lamp, 230 V/1.5 mA, fluorescent, for card switch     | 10/100  |
| 8370R | 6438199004860 | Lamp, 250 V/0.4 mA, LED, for 1-gang switches         | 10/100  |
| 8375R | 6438199004877 | Lamp, 5-24 V/0.5-2.5 mA, LED, for 1-gang switches    | 10/100  |

**Claws**

Claws for socket outlets, switches and push switches.



| Type | EAN           | Description                           | Package |
|------|---------------|---------------------------------------|---------|
| ASE1 | 6410021660932 | Claws for socket outlets and switches | 10/100  |

**Impulse spring**

The impulse spring can be installed into ABB switches. The impulse spring changes the switch operation to push switch. The impulse spring can be installed to 1, 1 + 1 + 1, 5, 6, and 6 + 6 switches. Sales package contains 10 springs. 10 pcs in sales pack.



| Type   | EAN           | Description                             | Package |
|--------|---------------|---|---------|
| PJ4.10 | 6438199004808 | Impulse spring for ABB switches, 10 pcs | 10/100  |

## Impressivo cover frames



### Flush mounting cover frames 85 mm, IP21/IP44

Flush mounting cover frames for 1-gang devices. Suitable for both horizontal and vertical installation. Standard installation is IP21 on smooth surface. When using seal 2463 installation is IP21 on rough surface. Final IP class of installation is defined by the used center plate (IP21/IP44).

| Type              | EAN           | Description  | Package |
|-------------------|---------------|--|---------|
| <b>White</b>      |               |  |         |
| 1721F85-84        | 6418677327773 | Cover frame, Impressivo, 85 mm, 1-gang, white      | 1/10    |
| 1722F85-84        | 6418677327810 | Cover frame, Impressivo, 85 mm, 2-gang, white      | 1/5     |
| 1723F85-84        | 6418677327858 | Cover frame, Impressivo, 85 mm, 3-gang, white      | 1/5     |
| 1724F85-84        | 6418677327896 | Cover frame, Impressivo, 85 mm, 4-gang, white      | 1/5     |
| 1725F85-84        | 6418677327933 | Cover frame, Impressivo, 85 mm, 5-gang, white      | 1/5     |
| <b>Anthracite</b> |               |  |         |
| 1721F85-81        | 6418677327797 | Cover frame, Impressivo, 85 mm, 1-gang, anthracite | 1/10    |
| 1722F85-81        | 6418677327834 | Cover frame, Impressivo, 85 mm, 2-gang, anthracite | 1/5     |
| 1723F85-81        | 6418677327872 | Cover frame, Impressivo, 85 mm, 3-gang, anthracite | 1/5     |
| 1724F85-81        | 6418677327919 | Cover frame, Impressivo, 85 mm, 4-gang, anthracite | 1/5     |
| 1725F85-81        | 6418677327957 | Cover frame, Impressivo, 85 mm, 5-gang, anthracite | 1/5     |
| <b>Aluminum</b>   |               |  |         |
| 1721F85-83        | 6418677327803 | Cover frame, Impressivo, 85 mm, 1-gang, aluminum   | 1/10    |
| 1722F85-83        | 6418677327841 | Cover frame, Impressivo, 85 mm, 2-gang, aluminum   | 1/5     |
| 1723F85-83        | 6418677327889 | Cover frame, Impressivo, 85 mm, 3-gang, aluminum   | 1/5     |
| 1724F85-83        | 6418677327926 | Cover frame, Impressivo, 85 mm, 4-gang, aluminum   | 1/5     |
| 1725F85-83        | 6418677327964 | Cover frame, Impressivo, 85 mm, 5-gang, aluminum   | 1/5     |



### Flush mounting cover frames 100 mm, IP21/IP44

Flush mounting cover frames for 2-gang devices, such as double socket outlets. Also 1-gang devices, such as switches, can be installed using adapter 2519-xx. Suitable for both horizontal and vertical installation. Standard installation is IP21 on smooth surface. When using seal 2463 installation is IP21 on rough surface. Final IP class of installation is defined by the used center plate (IP21/IP44).

| Type              | EAN           | Description   | Package |
|-------------------|---------------|---|---------|
| <b>White</b>      |               |   |         |
| 1721F100-84       | 6418677327971 | Cover frame, Impressivo, 100 mm, 1-gang, white      | 1/10    |
| 1722F100-84       | 6418677328015 | Cover frame, Impressivo, 100 mm, 2-gang, white      | 1/5     |
| 1723F100-84       | 6418677328053 | Cover frame, Impressivo, 100 mm, 3-gang, white      | 1/5     |
| 1724F100-84       | 6418677328091 | Cover frame, Impressivo, 100 mm, 4-gang, white      | 1/5     |
| 1725F100-84       | 6418677328138 | Cover frame, Impressivo, 100 mm, 5-gang, white      | 1/5     |
| <b>Anthracite</b> |               |   |         |
| 1721F100-81       | 6418677327995 | Cover frame, Impressivo, 100 mm, 1-gang, anthracite | 1/10    |
| 1722F100-81       | 6418677328039 | Cover frame, Impressivo, 100 mm, 2-gang, anthracite | 1/5     |
| 1723F100-81       | 6418677328077 | Cover frame, Impressivo, 100 mm, 3-gang, anthracite | 1/5     |
| 1724F100-81       | 6418677328114 | Cover frame, Impressivo, 100 mm, 4-gang, anthracite | 1/5     |
| 1725F100-81       | 6418677328152 | Cover frame, Impressivo, 100 mm, 5-gang, anthracite | 1/5     |
| <b>Aluminum</b>   |               |   |         |
| 1721F100-83       | 6418677328008 | Cover frame, Impressivo, 100 mm, 1-gang, aluminum   | 1/10    |
| 1722F100-83       | 6418677328046 | Cover frame, Impressivo, 100 mm, 2-gang, aluminum   | 1/5     |
| 1723F100-83       | 6418677328084 | Cover frame, Impressivo, 100 mm, 3-gang, aluminum   | 1/5     |
| 1724F100-83       | 6418677328121 | Cover frame, Impressivo, 100 mm, 4-gang, aluminum   | 1/5     |
| 1725F100-83       | 6418677328169 | Cover frame, Impressivo, 100 mm, 5-gang, aluminum   | 1/5     |

## Design frames



### Carat® cover frames

Flush mounting cover frames for 85 mm center plate accessories, such as switches. Suitable for both horizontal and vertical installation. Use at least one screw-mounted rocker frame (2474 or 2475) when fastening carat®-frames.

| Type               | EAN           | Description                                    | Package |
|--------------------|---------------|--|---------|
| <b>Black glass</b> |               |  |         |
| 1721-825           | 4011395088913 | Cover frame, Carat, 1-gang, Black              | 1       |
| 1722-825           | 4011395088920 | Cover frame, Carat, 2-gang, Black              | 1       |
| 1723-825           | 4011395088937 | Cover frame, Carat, 3-gang, Black              | 1       |
| 1724-825           | 4011395088944 | Cover frame, Carat, 4-gang, Black              | 1       |
| <b>White glass</b> |               |  |         |
| 1721-811           | 4011395157015 | Cover frame, Carat, 1-gang, white glass        | 1       |
| 1722-811           | 4011395157022 | Cover frame, Carat, 2-gang, white glass        | 1       |
| 1723-811           | 4011395157039 | Cover frame, Carat, 3-gang, white glass        | 1       |
| 1724-811           | 4011395157046 | Cover frame, Carat, 4-gang, white glass        | 1       |
| <b>Steel</b>       |               |  |         |
| 1721-860           | 6418677330186 | Cover frame, Carat, 1-gang, Steel              | 1       |
| 1722-860           | 6418677330193 | Cover frame, Carat, 2-gang, Steel              | 1       |
| 1723-860           | 6418677330209 | Cover frame, Carat, 3-gang, Steel              | 1       |
| 1724-860           | 6418677330216 | Cover frame, Carat, 4-gang, Steel              | 1       |
| <b>Bronze</b>      |               |  |         |
| 1721-821           | 6418677330223 | Cover frame, Carat, 1-gang, Bronze             | 1       |
| 1722-821           | 6418677330230 | Cover frame, Carat, 2-gang, Bronze             | 1       |
| 1723-821           | 6418677330247 | Cover frame, Carat, 3-gang, Bronze             | 1       |
| 1724-821           | 6418677330254 | Cover frame, Carat, 4-gang, Bronze             | 1       |
| <b>Chrome</b>      |               |  |         |
| 1721-826           | 6418677330339 | Cover frame, Carat, 1-gang, Chrome             | 1       |
| 1722-826           | 6418677330346 | Cover frame, Carat, 2-gang, horizontal, Chrome | 1       |
| 1723-826           | 6418677330360 | Cover frame, Carat, 3-gang, horizontal, Chrome | 1       |
| 1724-826           | 6418677330384 | Cover frame, Carat, 4-gang, horizontal, Chrome | 1       |
| <b>Gold</b>        |               |  |         |
| 1721-823           | 6418677330261 | Cover frame, Carat, 1-gang, Gold               | 1       |
| 1722-823           | 6418677330278 | Cover frame, Carat, 2-gang, horizontal, Gold   | 1       |
| 1723-823           | 6418677330292 | Cover frame, Carat, 3-gang, horizontal, Gold   | 1       |
| 1724-823           | 6418677330315 | Cover frame, Carat, 4-gang, horizontal, Gold   | 1       |



### axcent cover frames, white glass

Flush mounting cover frames for 1-gang center plate accessories, such as switches. Suitable for both horizontal and vertical installation. Material pure glass.

| Type                                      | EAN           | Description                              | Package |
|---|---------------|--|---------|
| <b>White glass. Delivery time 3 weeks</b> |               |  |         |
| 1721-280                                  | 4011395156957 | Cover frame, axcent, 1-gang, white glass | 1       |
| 1722-280                                  | 4011395156964 | Cover frame, axcent, 2-gang, white glass | 1       |
| 1723-280                                  | 4011395156971 | Cover frame, axcent, 3-gang, white glass | 1       |
| 1724-280                                  | 4011395156988 | Cover frame, axcent, 4-gang, white glass | 1       |
| 1725-280                                  | 4011395156995 | Cover frame, axcent, 5-gang, white glass | 1       |

**axcent cover frames, special colors**

Flush mounting cover frames for 1-gang center plate accessories, such as switches. Suitable for both horizontal and vertical installation. Plastic material.

| Type   | EAN           | Description                                | Package |
|--|---------------|--|---------|
| <b>Entrée-grey. Delivery time 3 weeks.</b>   |               |  |         |
| 1721-291                                     | 4011395165072 | Cover frame, axcent, 1-gang, entrée-grey   | 1       |
| 1722-291                                     | 4011395165195 | Cover frame, axcent, 2-gang, entrée-grey   | 1       |
| 1723-291                                     | 4011395165317 | Cover frame, axcent, 3-gang, entrée-grey   | 1       |
| 1724-291                                     | 4011395165423 | Cover frame, axcent, 4-gang, entrée-grey   | 1       |
| 1725-291                                     | 4011395165539 | Cover frame, axcent, 5-gang, entrée-grey   | 1       |
| <b>Château-black. Delivery time 3 weeks.</b> |               |  |         |
| 1721-295                                     | 4011395165096 | Cover frame, axcent, 1-gang, château-black | 1       |
| 1722-295                                     | 4011395165225 | Cover frame, axcent, 2-gang, château-black | 1       |
| 1723-295                                     | 4011395165331 | Cover frame, axcent, 3-gang, château-black | 1       |
| 1724-295                                     | 4011395165447 | Cover frame, axcent, 4-gang, château-black | 1       |
| 1725-295                                     | 4011395165553 | Cover frame, axcent, 5-gang, château-black | 1       |
| <b>Chalet-white. Delivery time 3 weeks.</b>  |               |  |         |
| 1721-296                                     | 4011395165126 | Cover frame, axcent, 1-gang, chalet-white  | 1       |
| 1722-296                                     | 4011395165249 | Cover frame, axcent, 2-gang, chalet-white  | 1       |
| 1723-296                                     | 4011395165355 | Cover frame, axcent, 3-gang, chalet-white  | 1       |
| 1724-296                                     | 4011395165461 | Cover frame, axcent, 4-gang, chalet-white  | 1       |
| 1725-296                                     | 4011395165577 | Cover frame, axcent, 5-gang, chalet-white  | 1       |
| <b>Foyer-red. Delivery time 3 weeks.</b>     |               |  |         |
| 1721-297                                     | 4011395165157 | Cover frame, axcent, 1-gang, foyer-red     | 1       |
| 1722-297                                     | 4011395165263 | Cover frame, axcent, 2-gang, foyer-red     | 1       |
| 1723-297                                     | 4011395165379 | Cover frame, axcent, 3-gang, foyer-red     | 1       |
| 1724-297                                     | 4011395165485 | Cover frame, axcent, 4-gang, foyer-red     | 1       |
| 1725-297                                     | 4011395165591 | Cover frame, axcent, 5-gang, foyer-red     | 1       |
| <b>Maison-beige. Delivery time 3 weeks.</b>  |               |  |         |
| 1721-299                                     | 4011395165171 | Cover frame, axcent, 1-gang, maison-beige  | 1       |
| 1722-299                                     | 4011395165287 | Cover frame, axcent, 2-gang, maison-beige  | 1       |
| 1723-299                                     | 4011395165393 | Cover frame, axcent, 3-gang, maison-beige  | 1       |
| 1724-299                                     | 4011395165515 | Cover frame, axcent, 4-gang, maison-beige  | 1       |
| 1725-299                                     | 4011395165621 | Cover frame, axcent, 5-gang, maison-beige  | 1       |

**accent cover frames, basic colors**

Flush mounting cover frames for 1-gang center plate accessories, such as switches. Suitable for both horizontal and vertical installation. Plastic material.

| Type                                  | EAN           | Description                         | Package |
|---------------------------------------|---------------|-------------------------------------|---------|
| <b>White. Delivery time 3 weeks.</b>  |               |                                     |         |
| 1721-284                              | 4011395113240 | Cover frame, accent, 1-gang, white  | 1       |
| 1722-284                              | 4011395113257 | Cover frame, accent, 2-gang, white  | 1       |
| 1723-284                              | 4011395113264 | Cover frame, accent, 3-gang, white  | 1       |
| 1724-284                              | 4011395113417 | Cover frame, accent, 4-gang, white  | 1       |
| 1725-284                              | 4011395113424 | Cover frame, accent, 5-gang, white  | 1       |
| <b>Black. Delivery time 3 weeks.</b>  |               |                                     |         |
| 1721-281                              | 4011395126363 | Cover frame, accent, 1-gang, black  | 1       |
| 1722-281                              | 4011395126370 | Cover frame, accent, 2-gang, black  | 1       |
| 1723-281                              | 4011395126387 | Cover frame, accent, 3-gang, black  | 1       |
| 1724-281                              | 4011395126394 | Cover frame, accent, 4-gang, black  | 1       |
| 1725-281                              | 4011395126615 | Cover frame, accent, 5-gang, black  | 1       |
| <b>Yellow. Delivery time 3 weeks.</b> |               |                                     |         |
| 1721-285                              | 4011395113271 | Cover frame, accent, 1-gang, yellow | 1       |
| 1722-285                              | 4011395113288 | Cover frame, accent, 2-gang, yellow | 1       |
| 1723-285                              | 4011395113295 | Cover frame, accent, 3-gang, yellow | 1       |
| 1724-285                              | 4011395113431 | Cover frame, accent, 4-gang, yellow | 1       |
| 1725-285                              | 4011395113448 | Cover frame, accent, 5-gang, yellow | 1       |
| <b>Green. Delivery time 3 weeks.</b>  |               |                                     |         |
| 1721-286                              | 4011395113318 | Cover frame, accent, 1-gang, green  | 1       |
| 1722-286                              | 4011395113325 | Cover frame, accent, 2-gang, green  | 1       |
| 1723-286                              | 4011395113332 | Cover frame, accent, 3-gang, green  | 1       |
| 1724-286                              | 4011395113455 | Cover frame, accent, 4-gang, green  | 1       |
| 1725-286                              | 4011395113462 | Cover frame, accent, 5-gang, green  | 1       |
| <b>Red. Delivery time 3 weeks.</b>    |               |                                     |         |
| 1721-287                              | 4011395113349 | Cover frame, accent, 1-gang, red    | 1       |
| 1722-287                              | 4011395113356 | Cover frame, accent, 2-gang, red    | 1       |
| 1723-287                              | 4011395113363 | Cover frame, accent, 3-gang, red    | 1       |
| 1724-287                              | 4011395113479 | Cover frame, accent, 4-gang, red    | 1       |
| 1725-287                              | 4011395113486 | Cover frame, accent, 5-gang, red    | 1       |
| <b>Blue. Delivery time 3 weeks.</b>   |               |                                     |         |
| 1721-288                              | 4011395113370 | Cover frame, accent, 1-gang, blue   | 1       |
| 1722-288                              | 4011395113387 | Cover frame, accent, 2-gang, blue   | 1       |
| 1723-288                              | 4011395113394 | Cover frame, accent, 3-gang, Blue   | 1       |
| 1724-288                              | 4011395113493 | Cover frame, accent, 4-gang, blue   | 1       |
| 1725-288                              | 4011395113516 | Cover frame, accent, 5-gang, blue   | 1       |



**Cover frames**

Flush mounting cover frames for 1-gang center plated accessories, such as switches. Suitable for both horizontal and vertical installation.

| Type                                      | EAN           | Description                            | Package |
|---|---------------|--|---------|
| <b>Steel</b>                              |               |  |         |
| 1721-866K                                 | 4011395088319 | Cover frame, 80 mm, 1-gang, steel      | 1       |
| 1722-866K                                 | 4011395088340 | Cover frame, 80 mm, 2-gang, steel      | 1       |
| 1723-866K                                 | 4011395088371 | Cover frame, 80 mm, 3-gang, steel      | 1       |
| 1724-866K                                 | 4011395088395 | Cover frame, 80 mm, 4-gang, steel      | 1       |
| 1725-866K                                 | 4011395088425 | Cover frame, 80 mm, 5-gang, steel      | 1       |
| <b>White matt. Delivery time 3 weeks.</b> |               |  |         |
| 1721-884K                                 | 4011395128244 | Cover frame, 80 mm, 1-gang, white matt | 1       |
| 1722-884K                                 | 4011395128251 | Cover frame, 80 mm, 2-gang, white matt | 1       |
| 1723-884K                                 | 4011395128268 | Cover frame, 80 mm, 3-gang, white matt | 1       |
| 1724-884K                                 | 4011395128275 | Cover frame, 80 mm, 4-gang, white matt | 1       |
| 1725-884K                                 | 4011395128282 | Cover frame, 80 mm, 5-gang, white matt | 1       |
| <b>Black matt. Delivery time 3 weeks.</b> |               |  |         |
| 1721-885K                                 | 4011395128299 | Cover frame, 80 mm, 1-gang, black matt | 1       |
| 1722-885K                                 | 4011395128312 | Cover frame, 80 mm, 2-gang, black matt | 1       |
| 1723-885K                                 | 4011395128329 | Cover frame, 80 mm, 3-gang, black matt | 1       |
| 1724-885K                                 | 4011395128336 | Cover frame, 80 mm, 4-gang, black matt | 1       |
| 1725-885K                                 | 4011395128343 | Cover frame, 80 mm, 5-gang, black matt | 1       |

**Surface mounting**

Switches



**1-gang switches**

Switch with screwless terminals and lamp possibility. Rocker with clip-on fastening. IP21 when wires are installed downwards.

| Type                       | EAN           | Description   | Package |
|----------------------------|---------------|---|---------|
| <b>1-gang 2-way switch</b> |               |   |         |
| 1066A-84                   | 6438199003221 | 1-gang 2-way switch, 16AX/250 V, Impressivo, 2 X-terminals, white             | 1/10    |
| 1066A-81                   | 6438199003238 | 1-gang 2-way switch, 16AX/250 V, Impressivo, 2 X-terminals, anthracite        | 1/10    |
| 1066A-83                   | 6438199003245 | 1-gang 2-way switch, 16AX/250 V, Impressivo, 2 X-terminals, aluminum          | 1/10    |
| <b>Intermediate switch</b> |               |   |         |
| 1067A-84                   | 6438199003535 | 1-gang intermediate switch, 16AX/250 V, Impressivo, 2 X-terminals, white      | 1/10    |
| 1067A-81                   | 6438199003542 | 1-gang intermediate switch, 16AX/250 V, Impressivo, 2 X-terminals, anthracite | 1/10    |
| 1067A-83                   | 6438199003559 | 1-gang intermediate switch, 16AX/250 V, Impressivo, 2 X-terminals, aluminum   | 1/10    |



**2-gang switches**

Switch with screwless terminals, no lamp possibility. Rocker with clip-on fastening. IP21 when wires are installed downwards.

| Type                       | EAN           | Description  | Package |
|----------------------------|---------------|--|---------|
| <b>2-gang 1-way switch</b> |               |  |         |
| 1065A-84                   | 6438199003191 | 2-gang 1-way switch, 16AX/250 V, Impressivo, 2 X-terminals, white      | 1/10    |
| 1065A-81                   | 6438199003207 | 2-gang 1-way switch, 16AX/250 V, Impressivo, 2 X-terminals, anthracite | 1/10    |
| 1065A-83                   | 6438199003214 | 2-gang 1-way switch, 16AX/250 V, Impressivo, 2 X-terminals, aluminum   | 1/10    |
| <b>2-gang 2-way switch</b> |               |  |         |
| 10666A-84                  | 6438199003504 | 2-gang 2-way switch, 16AX/250 V, Impressivo, 2 X-terminals, white      | 1/10    |
| 10666A-81                  | 6438199003511 | 2-gang 2-way switch, 16AX/250 V, Impressivo, 2 X-terminals, anthracite | 1/10    |
| 10666A-83                  | 6438199003528 | 2-gang 2-way switch, 16AX/250 V, Impressivo, 2 X-terminals, aluminum   | 1/10    |

**3-gang switch**

Switch with screwless terminals, no lamp possibility. Rocker with clip-on fastening. IP21 when wires are installed downwards.

| Type      | EAN           | Description  | Package |
|-----------|---------------|--|---------|
| 10631A-84 | 6438199003566 | 3-gang 1-way switch, 16AX/250 V, Impressivo, 2 X-terminals, white      | 1/10    |
| 10631A-81 | 6438199003573 | 3-gang 1-way switch, 16AX/250 V, Impressivo, 2 X-terminals, anthracite | 1/10    |
| 10631A-83 | 6438199003580 | 3-gang 1-way switch, 16AX/250 V, Impressivo, 2 X-terminals, aluminum   | 1/10    |

**2-pole switch**

Switch with screwless terminals and lamp possibility. Rocker with clip-on fastening. IP21 when wires are installed downwards.

| Type     | EAN           | Description  | Package |
|----------|---------------|--|---------|
| 1062A-84 | 6438199003474 | 1-gang 2-pole switch, 16AX/250 V, Impressivo, 2 X-terminals, white | 1/10    |

**1-gang push switch**

Push switch with screwless terminals and lamp possibility. Rocker with clip-on fastening. Delivered with clear lens. IP21 when the wires are installed downwards.

| Type     | EAN           | Description   | Package |
|----------|---------------|---|---------|
| 1461A-84 | 6438199003252 | 1-gang 1-way push switch, 10 A/250 V, Impressivo, 2 X-terminals, white      | 1/10    |
| 1461A-81 | 6438199003269 | 1-gang 1-way push switch, 10 A/250 V, Impressivo, 2 X-terminals, anthracite | 1/10    |
| 1461A-83 | 6438199003276 | 1-gang 1-way push switch, 10 A/250 V, Impressivo, 2 X-terminals, aluminum   | 1/10    |

## Socket outlets IP21

**4-gang Schuko socket outlet, IP21**

The device is based on two 2-gang socket outlet inserts, which are internally connected. The socket outlet inserts have shutters. There are screwless terminals for each contact of the socket outlet insert for max 4 rigid wires. No X-terminals. IP21 when the wires are installed downwards.

| Type     | EAN           | Description   | Package |
|----------|---------------|---|---------|
| 404EA-84 | 6438199003344 | Socket outlet, Impressivo, Schuko, 4-gang, shuttered, screwless terminals, white      | 1/20    |
| 404EA-81 | 6438199003351 | Socket outlet, Impressivo, Schuko, 4-gang, shuttered, screwless terminals, anthracite | 1/20    |
| 404EA-83 | 6438199003368 | Socket outlet, Impressivo, Schuko, 4-gang, shuttered, screwless terminals, aluminum   | 1/20    |

**2-gang Schuko socket outlet, IP21**

Screwless terminals for each contact of the socket outlet for max 4 rigid wires. No X-terminals. The socket outlet insert has shutters. IP21 when the wires are installed downwards.

| Type     | EAN           | Description   | Package |
|----------|---------------|---|---------|
| 402EA-84 | 6438199003283 | Socket outlet, Impressivo, Schuko, 2-gang, shuttered, screwless terminals, white      | 1/10    |
| 402EA-81 | 6438199003290 | Socket outlet, Impressivo, Schuko, 2-gang, shuttered, screwless terminals, anthracite | 1/10    |
| 402EA-83 | 6438199003306 | Socket outlet, Impressivo, Schuko, 2-gang, shuttered, screwless terminals, aluminum   | 1/10    |





**2-gang Schuko socket outlet, surface mounting, IP44**

Product includes Schuko socket outlet insert, center plate with lid, surface mounting cover frame and box. The socket outlet insert has shutters and screwless terminals.

| Type      | EAN           | Description  | Package |
|-----------|---------------|--|---------|
| 302ESW-81 | 6438199003443 | Socket outlet, Impressivo IP44, 2-gang Schuko, shuttered, screwless terminals, branching terminals, anthracite | 1/10    |



**2-gang Schuko outlets with special colour, IP21**

Screwless terminals for each contact of the socket outlet for max 4 rigid wires. No X-terminals. The socket outlet insert has shutters. IP21 when the wires are installed downwards. These socket outlets can be used, for instance, in hospitals and offices, when there is a need to limit socket outlet use to certain applications.

| Type     | EAN           | Description   | Package |
|----------|---------------|---|---------|
| 402EA-02 | 6438199004723 | Socket outlet, Impressivo, Schuko, 2-gang, shuttered, screwless terminals, red    | 1/10    |
| 402EA-03 | 6438199004730 | Socket outlet, Impressivo, Schuko, 2-gang, shuttered, screwless terminals, orange | 1/10    |
| 402EA-05 | 6438199004747 | Socket outlet, Impressivo, Schuko, 2-gang, shuttered, screwless terminals, green  | 1/10    |
| 402EA-06 | 6438199004754 | Socket outlet, Impressivo, Schuko, 2-gang, shuttered, screwless terminals, blue   | 1/10    |



**2-gang Schuko socket outlet, lath installation, IP21**

Schuko 2-gang socket outlet for lath installation. There are screwless terminals for each contact of the socket outlet for max 4 rigid wires. No X-terminals. The socket outlet insert has shutters.

| Type     | EAN           | Description  | Package |
|----------|---------------|--|---------|
| 402EL-84 | 6438199003894 | Socket outlet, Impressivo, Schuko, 2-gang, shuttered, screwless terminals, lath installation, white      | 1/10    |
| 402EL-81 | 6438199003900 | Socket outlet, Impressivo, Schuko, 2-gang, shuttered, screwless terminals, lath installation, anthracite | 1/10    |
| 402EL-83 | 6438199003917 | Socket outlet, Impressivo, Schuko, 2-gang, shuttered, screwless terminals, lath installation, aluminium  | 1/10    |



**2-gang Schuko socket outlet, corner installation, IP21**

Schuko 2-gang socket outlet for corner installation. There are screwless terminals for each contact of the socket outlet for max 4 rigid wires. No X-terminals. The socket outlet insert has shutters.

| Type     | EAN           | Description  | Package |
|----------|---------------|--|---------|
| 402EE-84 | 6438199003313 | Socket outlet, Impressivo, Schuko, 2-gang, shuttered, screwless terminals, corner installation, white      | 1/20    |
| 402EE-81 | 6438199003320 | Socket outlet, Impressivo, Schuko, 2-gang, shuttered, screwless terminals, corner installation, anthracite | 1/20    |
| 402EE-83 | 6438199003337 | Socket outlet, Impressivo, Schuko, 2-gang, shuttered, screwless terminals, corner installation, aluminum   | 1/20    |

Surface mounting boxes and accessories



**Surface mounting box 85 mm, IP21**

Surface mounting box for 1-gang devices such as antenna and data outlet and others, insert height max. 26 mm. Large devices such as dimmers doesn't fit in the box. Delivery includes bottom plate and cover.

| Type     | EAN           | Description  | Package |
|----------|---------------|--|---------|
| 1721A-84 | 6438199003375 | Surface mounting box, Impressivo, 85 mm, h=41 mm, 1-gang, white      | 1/10    |
| 1721A-81 | 6438199003382 | Surface mounting box, Impressivo, 85 mm, h=41 mm, 1-gang, anthracite | 1/10    |
| 1721A-83 | 6438199003399 | Surface mounting box, Impressivo, 85 mm, h=41 mm, 1-gang, aluminum   | 1/10    |

**Lath installation box 85 mm, IP21**

Lath installation box for 1-gang devices such as antenna and data outlet and others, insert height max. 26 mm. Large devices such as dimmers doesn't fit in the box. Delivery includes bottom plate and cover.

| Type     | EAN           | Description  | Package |
|----------|---------------|--|---------|
| 1721L-84 | 6438199003924 | Surface mounting box, Impressivo, 85 mm, 1-gang, lath installation, white      | 1/10    |
| 1721L-81 | 6438199003931 | Surface mounting box, Impressivo, 85 mm, 1-gang, lath installation, anthracite | 1/10    |
| 1721L-83 | 6438199003948 | Surface mounting box, Impressivo, 85 mm, 1-gang, lath installation, aluminium  | 1/10    |

**Corner installation box 85 mm, IP21**

Surface mounting box for 2 devices, also for electronic devices. Horizontal or vertical installation in corners. Use with 85 mm 2-gang cover frame.

| Type     | EAN           | Description  | Package |
|----------|---------------|--|---------|
| 1722H-84 | 6438199003955 | Surface mounting box, Impressivo, corner installation, 85 mm, 2-gang, white      | 1/20    |
| 1722H-81 | 6438199003962 | Surface mounting box, Impressivo, corner installation, 85 mm, 2-gang, anthracite | 1/20    |
| 1722H-83 | 6438199003979 | Surface mounting box, Impressivo, corner installation, 85 mm, 2-gang, aluminium  | 1/20    |

**Surface mounting bottom plate, IP21/IP44**

Surface mounting bottom plate for flush mounted products, insert height max. 26 mm. To be combined with 85 mm and 100 mm surface mounting cover frames 172xS85-xx and 172xS100-xx. Socket outlets are IP44 when using center plates with hinged lid. Switches and push switches are IP44 when combined with screw fastening rocker. Wires must be installed downwards for IP44 protection class. Dimmers do not fit in the box.

| Type    | EAN           | Description  | Package |
|---------|---------------|--|---------|
| 2456.26 | 6418677331299 | Surface mounting box for flush mounted products, h=26 mm | 10/100  |

**Surface mounting cover frames 85 mm, IP21/IP44**

Surface mounting cover frames for 1-gang devices, such as switches and socket outlets. Suitable for both horizontal and vertical installation. To be used with surface mounting box 2456.26. Dimmers do not fit in the frame. Wires must be installed downwards for IP44 protection class. Final IP class of installation is defined by the used center plate (IP21/IP44).

| Type              | EAN           | Description  | Package |
|-------------------|---------------|--|---------|
| <b>White</b>      |               |  |         |
| 1721S85-84        | 6418677330971 | Surface mounting frame, Impressivo, 85 mm, h=40 mm, 1-gang, white      | 1/50    |
| 1722S85-84        | 6418677331015 | Surface mounting frame, Impressivo, 85 mm, h=40 mm, 2-gang, white      | 1/25    |
| 1723S85-84        | 6418677331053 | Surface mounting frame, Impressivo, 85 mm, h=40 mm, 3-gang, white      | 1/25    |
| 1724S85-84        | 6418677331091 | Surface mounting frame, Impressivo, 85 mm, h=40 mm, 4-gang, white      | 1/25    |
| <b>Anthracite</b> |               |  |         |
| 1721S85-81        | 6418677330995 | Surface mounting frame, Impressivo, 85 mm, h=40 mm, 1-gang, anthracite | 1/50    |
| 1722S85-81        | 6418677331039 | Surface mounting frame, Impressivo, 85 mm, h=40 mm, 2-gang, anthracite | 1/25    |
| 1723S85-81        | 6418677331077 | Surface mounting frame, Impressivo, 85 mm, h=40 mm, 3-gang, anthracite | 1/25    |
| 1724S85-81        | 6418677331114 | Surface mounting frame, Impressivo, 85 mm, h=40 mm, 4-gang, anthracite | 1/25    |
| <b>Aluminum</b>   |               |  |         |
| 1721S85-83        | 6418677331008 | Surface mounting frame, Impressivo, 85 mm, h=40 mm, 1-gang, aluminum   | 1/50    |
| 1722S85-83        | 6418677331046 | Surface mounting frame, Impressivo, 85 mm, h=40 mm, 2-gang, aluminum   | 1/25    |
| 1723S85-83        | 6418677331084 | Surface mounting frame, Impressivo, 85 mm, h=40 mm, 3-gang, aluminum   | 1/25    |
| 1724S85-83        | 6418677331121 | Surface mounting frame, Impressivo, 85 mm, h=40 mm, 4-gang, aluminum   | 1/25    |



**Surface mounting cover frames 100 mm, IP21/IP44**

Surface mounting cover frames for 2-gang devices, such as double socket outlets. Also 1-gang devices can be installed using the adaptor 2519-xx. Suitable for both horizontal and vertical installation. To be used with surface mounting box 2456.26. Wires must be installed downwards for IP44 protection class. Final IP class of installation is defined by the used center plate (IP21/IP44).

| Type              | EAN           | Description   | Package |
|-------------------|---------------|---|---------|
| <b>White</b>      |               |   |         |
| 1721S100-84       | 6418677331138 | Surface mounting frame, Impressivo, 100 mm, h=40 mm, 1-gang, white      | 1/50    |
| 1722S100-84       | 6418677331176 | Surface mounting frame, Impressivo, 100 mm, h=40 mm, 2-gang, white      | 1/25    |
| 1723S100-84       | 6418677331213 | Surface mounting frame, Impressivo, 100 mm, h=40 mm, 3-gang, white      | 1/25    |
| 1724S100-84       | 6418677331251 | Surface mounting frame, Impressivo, 100 mm, h=40 mm, 4-gang, white      | 1/20    |
| <b>Anthracite</b> |               |   |         |
| 1721S100-81       | 6418677331152 | Surface mounting frame, Impressivo, 100 mm, h=40 mm, 1-gang, anthracite | 1/50    |
| 1722S100-81       | 6418677331190 | Surface mounting frame, Impressivo, 100 mm, h=40 mm, 2-gang, anthracite | 1/25    |
| 1723S100-81       | 6418677331237 | Surface mounting frame, Impressivo, 100 mm, h=40 mm, 3-gang, anthracite | 1/25    |
| 1724S100-81       | 6418677331275 | Surface mounting frame, Impressivo, 100 mm, h=40 mm, 4-gang, anthracite | 1/20    |
| <b>Aluminum</b>   |               |   |         |
| 1721S100-83       | 6418677331169 | Surface mounting frame, Impressivo, 100 mm, h=40 mm, 1-gang, aluminum   | 1/50    |
| 1722S100-83       | 6418677331206 | Surface mounting frame, Impressivo, 100 mm, h=40 mm, 2-gang, aluminum   | 1/25    |
| 1723S100-83       | 6418677331244 | Surface mounting frame, Impressivo, 100 mm, h=40 mm, 3-gang, aluminum   | 1/25    |
| 1724S100-83       | 6418677331282 | Surface mounting frame, Impressivo, 100 mm, h=40 mm, 4-gang, aluminum   | 1/20    |



**High surface mounting boxes 80 mm, IP20**

Surface mounting boxes for high 1-gang devices, such as dimmers, insert height max. 40 mm. Suitable for both horizontal and vertical installation. Delivery includes box and cover frame.

| Type              | EAN           | Description   | Package |
|-------------------|---------------|---|---------|
| <b>White</b>      |               |   |         |
| 1721S80-84        | 6438199002651 | Surface mounting box, Impressivo, 80 mm, h=54 mm 1-gang, white      | 1/10    |
| 1722S80-84        | 6438199002682 | Surface mounting box, Impressivo, 80 mm, h=54 mm 2-gang, white      | 1/5     |
| 1723S80-84        | 6438199002712 | Surface mounting box, Impressivo, 80 mm, h=54 mm 3-gang, white      | 1/10    |
| <b>Anthracite</b> |               |   |         |
| 1721S80-81        | 6438199002637 | Surface mounting box, Impressivo, 80 mm, h=54 mm 1-gang, anthracite | 1/10    |
| 1722S80-81        | 6438199002668 | Surface mounting box, Impressivo, 80 mm, h=54 mm 2-gang, anthracite | 1/5     |
| 1723S80-81        | 6438199002699 | Surface mounting box, Impressivo, 80 mm, h=54 mm 3-gang, anthracite | 1/10    |
| <b>Aluminum</b>   |               |   |         |
| 1721S80-83        | 6438199002644 | Surface mounting box, Impressivo, 80 mm, h=54 mm 1-gang, aluminum   | 1/10    |
| 1722S80-83        | 6438199002675 | Surface mounting box, Impressivo, 80 mm, h=54 mm 2-gang, aluminum   | 1/5     |
| 1723S80-83        | 6438199002705 | Surface mounting box, Impressivo, 80 mm, h=54 mm 3-gang, aluminum   | 1/10    |



**02**

**Jussi**

**Timeless and discrete for various styles of interior decoration.**



|   |    |
|---|----|
| <b>Flush mounting IP21</b>                  |    |
| Switches and push switches                  | 40 |
| Signal lights                               | 42 |
| Socket outlets                              | 42 |
| Tele and data                               | 45 |
| Cover frames and accessories                | 50 |
| <b>Surface mounting IP20/IP21</b>           |    |
| Surface mounting boxes and accessories      | 52 |
| Surface mounting switches and push switches | 53 |
| Surface mounting socket outlets             | 54 |
| <b>Surface mounting IP44/IP55</b>           |    |
| Switches, push switches and signal lights   | 55 |
| Socket outlets                              | 56 |





---

## Timeless design

The design of Jussi series is timeless and suitable for various styles of interior decoration. Its white silky surface (RAL9010) is easy to keep clean, and its high quality material sustain years of everyday use with no change in appearance or durability.

—  
01



—  
01

**Illustration in original size**  
The cover frame measures 85 mm x 85 mm x 19 mm (w x h x d). Material: the rocker and frame are made of thermoplastic (PC), impact- and break-proof, UV-resistant, PVC- and halogen-free

## Jussi flush mounting IP21

### Switches and push switches



#### Push button panel 4/2-gang, 5-24V AC/DC

4/2-gang push button panel to control bistable relays or electronic control systems. Load capacity 1 A AC/DC. White LED-light with adjustable illumination. Installation on surface or on top of a standard flush mounting box.

| Type    | EAN           | Description           | Package |
|---------|---------------|-----------------------|---------|
| FAP1204 | 6438199002279 | Push button, 4/2-gang | 1/10    |



#### Flush mounting 1-gang switches, IP21

16AX/250 V Switches with screwless terminals and rocker with clip-on fastening. The terminals are for max 2 rigid wires. Flush mounting on a smooth surface IP21.

| Type  | EAN           | Description                                      | Package |
|-------|---------------|--|---------|
| 1061U | 6410021060114 | 1-gang 1-way switch, Jussi, no X-terminals       | 10/100  |
| 1066U | 6410021060169 | 1-gang 2-way switch, Jussi, 2 X-terminals        | 10/100  |
| 1067U | 6410021060176 | 1-gang intermediate switch, Jussi, 2 X-terminals | 10/100  |



#### Flush mounting 2-gang switches, IP21

16AX/250 V Switches with screwless terminals and rocker with clip-on fastening. The terminals are for max 2 rigid wires. No lamp possibility. Flush mounting on a smooth surface IP21.

| Type    | EAN           | Description                                | Package |
|---------|---------------|--|---------|
| 1065U   | 6410021060152 | 2-gang 1-way switch, Jussi, no X-terminals | 10/100  |
| 1065U.1 | 6410021060657 | 2-gang 1-way switch, Jussi, 2 X-terminals  | 10/100  |
| 10666U  | 6410021060183 | 2-gang 2-way switch, Jussi, no X-terminals | 10/100  |



#### Flush mounting 3-gang switch, IP21

16AX/250 V Switch with screwless terminals and rocker with clip-on fastening. The terminals are for max 2 rigid wires. No lamp possibility. Flush mounting on a smooth surface IP21.

| Type   | EAN           | Description                                | Package |
|--------|---------------|--|---------|
| 10631U | 6410021060190 | 3-gang 1-way switch, Jussi, no X-terminals | 10/100  |



#### Flush mounting 2-pole switch, IP21

16AX/250 V Switch with screwless terminals and rocker with clip-on fastening. The terminals are for max 2 rigid wires. Flush mounting on a smooth surface IP21.

| Type  | EAN           | Description  | Package |
|-------|---------------|--|---------|
| 1062U | 6410021060121 | 2-pole 1-gang 1-way switch, Jussi, 2 X-terminals, "1/0" symbol | 10/100  |



#### Flush mounting 2-pole switch, IP21

16AX/250 V Switch with screwless terminals and rocker with clip-on fastening. The terminals are for max 2 rigid wires. Delivered with pilot light and red lens. Flush mounting on a smooth surface IP21.

| Type   | EAN           | Description  | Package |
|--------|---------------|--|---------|
| 1062UK | 6410021060145 | 2-pole 1-gang 1-way switch, Jussi, no X-terminals, red lens, "1/0" symbol, incl.lamp | 10/100  |





**Flush mounting 1-gang 2-way switch, IP21**

16AX/250V Switch with screwless terminals and rocker with clip-on fastening. The terminals are for max 2 rigid wires. Delivered with pilot light and red lens. Flush mounting on a smooth surface IP21.

| Type   | EAN           | Description  | Package |
|--------|---------------|--|---------|
| 1066UK | 6410021060138 | 1-gang 2-way switch, Jussi, N-terminal, red lens, incl. lamp | 10/100  |



**Flush mounting 1-gang 2-way push switch, IP21**

16A/250V Push switch with screwless terminals and rocker with clip-on fastening. The terminals are for max 2 rigid wires. Possibility to connect a lamp. Push switch includes an opening and closing contact terminal function.

| Type  | EAN           | Description   | Package |
|-------|---------------|---|---------|
| 1466U | 6410021260118 | 1-gang 2-way push switch, Jussi, N-terminal, lens, lamp not incl. | 10/100  |



**Flush mounting 2-gang 1-way push switch, IP21**

16A/250V Push switch with screwless terminals and rocker with clip-on fastening. The terminals are for max 2 rigid wires. No lamp possibility. Flush mounting on a smooth surface IP21.

| Type    | EAN           | Description  | Package |
|---------|---------------|--|---------|
| 1465U   | 6410021260132 | 2-gang 1-way push switch, 16 A, Jussi, no X-terminals                          | 10/100  |
| 1465.20 | 6418677328824 | 2-gang 1-way push switch insert 16 A/250 V, 2 X-terminals, no lamp possibility | 10/100  |



**2-gang push switch for up/down control, IP21**

10A/250V Push switch with screwless terminals and rocker with clip-on fastening. The terminals are for max 2 rigid wires. Use e.g. for controlling opening/closing of blinds and shutters. Not possible to push both buttons at the same time. Flush mounting on a smooth surface IP21.

| Type            | EAN           | Description                                    | Package |
|-----------------|---------------|--|---------|
| 2020/4U-101-212 | 6410021260156 | 2-gang push switch, Jussi, for up/down control | 10/100  |

**1-gang rockers, IP21**

Rockers with screw or clip-on fastening for all 1-gang switches and push switches. Flush mounting on a smooth surface IP21.



| Type      | EAN           | Description   | Package |
|-----------|---------------|---|---------|
| 2506-212  | 6410021061357 | Switch rocker, Jussi, 1-gang, clip-on fastening             | 20/200  |
| 2506-212R | 6410021061432 | Switch rocker, Jussi, 1-gang, screw fastening               | 20/200  |
| 2520-212  | 6410021061364 | Switch rocker, Jussi, 1-gang, clear lens, clip-on fastening | 20/200  |
| 2520-212R | 6410021061449 | Switch rocker, Jussi, 1-gang, clear lens, screw fastening   | 20/200  |

**2-gang rockers, IP21**

Rockers with screw or clip-on fastening for 2-gang switches and push switches. Flush mounting on a smooth surface IP21.



| Type      | EAN           | Description                                     | Package |
|-----------|---------------|---|---------|
| 2505-212  | 6410021061395 | Switch rocker, Jussi, 2-gang, clip-on fastening | 20/200  |
| 2505-212R | 6410021061470 | Switch rocker, Jussi, 2-gang, screw fastening   | 20/200  |

## Signal lights



### Lamps for switches

Lamps for switches and push buttons. Lamps can be installed in 1-gang switch inserts that include the signal-/ search light possibility. Lamps can't be installed in 2- or 3-gang switch inserts.

| Type  | EAN           | Description  | Package |
|-------|---------------|--|---------|
| 8370  | 6410021060701 | Lamp, 230 V/0.4 mA, fluorescent, for 1-gang switches | 10/100  |
| 8372  | 6410021060725 | Lamp, 230 V/2 mA, fluorescent, for 1-gang switches   | 10/100  |
| 8375  | 6410021060756 | Lamp, 24 V/22 mA, incandescent, for 1-gang switches  | 10/100  |
| 8376  | 6410021060763 | Lamp, 12 V/40 mA, incandescent, for 1-gang switches  | 10/100  |
| 8370R | 6438199004860 | Lamp, 250 V/0.4 mA, LED, for 1-gang switches         | 10/100  |
| 8375R | 6438199004877 | Lamp, 5-24 V/0.5-2.5 mA, LED, for 1-gang switches    | 10/100  |

### Rocker lens with symbols

Rocker lens with symbols for 1-gang Jussi-rockers with lens.

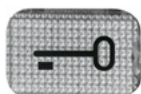

| Type   | EAN           | Description                              | Package |
|--------|---------------|--|---------|
| 2145TR | 4011395077108 | Rocker lens, Jussi, clear, "key" symbol  | 100     |
| 2145KI | 6410020464821 | Rocker lens, Jussi, clear, "bell" symbol | 100     |

### Signal light fittings

250V/max 3W, E-10 lamp, screw terminals. Cap with clip-on fastening is included. Lamp 8340 is not included. Can only be installed in dry indoor spaces (IP20).



| Type     | EAN           | Description   | Package  |
|----------|---------------|---|----------|
| 2661U-11 | 6410021460181 | Signal light, Jussi, E10/3W max, clear                      | 10/100   |
| 2661U-12 | 6410021460167 | Signal light, Jussi, E10/3W max, red                        | 10/100   |
| 2661U-13 | 6410021460150 | Signal light, Jussi, E10/3W max, green                      | 10/100   |
| 2661U-14 | 6410021460198 | Signal light, Jussi, E10/3W max, orange                     | 10/100   |
| 8340     | 6410021460891 | Lamp, 230 V/3W/E10, incandescent, for signal light fittings | 100/1000 |

## Socket outlets

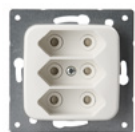

### Euro socket outlet with center plate, IP21

2,5A/250V There are screwless N and L terminals for max 4 wires and 2 screwless X-terminals for max 2 wires. The socket outlet insert has shutters. The terminals are for rigid wires. Flush mounting on a smooth surface IP21.

| Type  | EAN           | Description  | Package |
|-------|---------------|--|---------|
| 303UC | 6418677335136 | Socket outlet, Jussi, Euro, 3-gang, shuttered, screwless terminals, branching terminals, 2 X-terminals | 10/100  |



### 2-gang socket outlet Schuko with cover plate, screwless terminals, IP21

16A/250V. There are screwless terminals for each contact of the socket outlet for max 4 rigid wires. No X-terminals. The socket outlet insert has shutters. Flush mounting on a smooth surface IP21.

| Type        | EAN           | Description  | Package |
|-------------|---------------|--|---------|
| 302EUJ      | 6418677310409 | Socket outlet, Jussi, Schuko, 2-gang, shuttered, screwless terminals, branching terminals        | 10/100  |
| 302EUJ.CLAW | 6418677311628 | Socket outlet, Jussi, Schuko, 2-gang, shuttered, screwless terminals, branching terminals, claws | 10/100  |



**2-gang socket outlet Schuko with cover plate, screwless terminals, IP21**

16A/250V There are screwless terminals for each contact of the socket outlet for max 4 rigid wires. No X-terminals. The socket outlet insert has shutters. Flush mounting on a smooth surface IP21.

| Type     | EAN           | Description   | Package |
|----------|---------------|---|---------|
| 302EUJ.1 | 6418677331374 | Socket outlet, Jussi, Schuko, 2-gang, shuttered, screwless terminals, branching terminals | 10/100  |



**2-gang socket outlet Schuko with cover plate, screw terminals, IP21**

16A/250V There are screw terminals for each contact of the socket outlet and 2 X-terminals. The socket outlet insert has shutters. The terminals are for max 2 rigid wires. Flush mounting on a smooth surface IP21.

| Type   | EAN           | Description   | Package |
|--------|---------------|---|---------|
| 232EUJ | 6410025064217 | Socket outlet, Jussi, Schuko, 2-gang, shuttered, screw terminals, 2 X-terminals | 10/100  |



**2-gang socket outlet Schuko with center plate, screwless terminals, IP21**

16A/250V There are screwless terminals for each contact of the socket outlet for max 4 rigid wires. No X-terminals. The socket outlet insert has shutters. Flush mounting on a smooth surface IP21.

| Type        | EAN           | Description  | Package |
|-------------|---------------|--|---------|
| 302EUC      | 6418677310393 | Socket outlet, Jussi, Schuko, 2-gang, shuttered, screwless terminals, branching terminals        | 10/100  |
| 302EUC.CLAW | 6418677311635 | Socket outlet, Jussi, Schuko, 2-gang, shuttered, screwless terminals, branching terminals, claws | 10/100  |



**2-gang socket outlet Schuko with center plate, screw terminals, IP21**

16A/250V There are screw terminals for each contact of the socket outlet and 2 X-terminals. The terminals are for max 2 rigid wires. The socket outlet insert has shutters. Flush mounting on a smooth surface IP21.

| Type   | EAN           | Description   | Package |
|--------|---------------|---|---------|
| 232EUC | 6410025061216 | Socket outlet, Jussi, Schuko, 2-gang, shuttered, screw terminals, 2 X-terminals | 10/100  |



**Non-earthed socket outlet with center plate**

16A/250V There are terminals for N and L contact of the socket outlet for max 4 rigid wires. No X-terminals. The socket outlet insert has shutters. Claws can be fitted to socket outlet afterwards. Can only be installed in dry indoor spaces.

| Type  | EAN           | Description  | Package |
|-------|---------------|--|---------|
| 302UC | 6418677335808 | Socket outlet, Jussi, non-earthed, 2-gang, shuttered, screwless terminals, branching terminals | 10/100  |



**1-gang socket outlet Schuko with cover plate, IP21**

16A/250V There are screwless terminals for each contact of the socket outlet. The terminals are for max 2 rigid wires. The socket outlet insert has shutters. No X-terminals. Flush mounting on a smooth surface IP21.

| Type         | EAN           | Description   | Package |
|--------------|---------------|---|---------|
| 20EUJKS-212  | 6410025064316 | Socket outlet, Jussi, Schuko, 1-gang, shuttered, screwless terminals        | 10/100  |
| 20EUJ2       | 6418677302114 | Socket outlet, Jussi, Schuko, 1-gang, shuttered, screwless terminals, claws | 10/100  |
| 23-01EUJ-212 | 6410025064118 | Socket outlet, Jussi, Schuko, 1-gang, shuttered, screw terminals            | 10/100  |



#### 1-gang socket outlet Schuko with center plate, IP21

16 A/250 V There are screwless terminals for each contact of the socket outlet. The socket outlet insert has shutters. The terminals are for max 2 rigid wires. No X-terminals. Flush mounting on a smooth surface IP21.

| Type         | EAN           | Description   | Package |
|--------------|---------------|---|---------|
| 20EUCKS-212  | 6410025061315 | Socket outlet, Jussi, Schuko, 1-gang, shuttered, screwless terminals        | 10/100  |
| 20EUC2       | 6418677302060 | Socket outlet, Jussi, Schuko, 1-gang, shuttered, screwless terminals, claws | 10/100  |
| 23-01EUC-212 | 6410025061117 | Socket outlet, Jussi, Schuko, 1-gang, shuttered, screw terminals            | 10/100  |



#### 1-gang Schuko socket outlet with center plate and LED light, IP20

16 A/250 V There are screwless terminals for each contact of the socket outlet. The socket outlet insert has shutters. The terminals are for max 2 rigid wires. No X-terminals. A white color LED light is integrated into the socket outlet.

| Type         | EAN           | Description   | Package |
|--------------|---------------|---|---------|
| 20EUCBLI-214 | 4011395100738 | Socket outlet, Jussi, Schuko, 1-gang, shuttered, screwless terminals, LED light | 1/10    |



#### 1-gang Schuko socket outlet with center plate and USB charger, IP20

The socket outlet has an integrated USB charger 5 V/0.7 A with electronic short-circuit and overload protection. Compatible with USB devices, iPod and iPhone. The Schuko socket outlet is 16A/250V. There are screwless terminals for each contact of the socket outlet. The socket outlet insert has shutters. The terminals are for max 2 rigid wires. No X-terminals.

| Type          | EAN           | Description  | Package |
|---------------|---------------|--|---------|
| 20EUCBUSB-214 | 4011395164532 | 1-gang Socket outlet and USB charger, Jussi, shuttered Schuko, screwless terminals | 1       |



#### Residual current devices

16 A/250 V IP21, with built-in A-type residual current device (RCD), tripping current 30 mA. Approved for extending a branch circuit, but only regular sockets connected to protected outlet wires are protected. The socket outlet insert has shutters. The products are sold with cover plates. The socket outlet insert has shutters and screwless terminals.

| Type         | EAN           | Description             | Package |
|--------------|---------------|-------------------------|---------|
| 3120EUC-214  | 7612271473822 | 1-gang, 30 mA, type A   | 1/10    |
| 3150UC-214.1 | 7612271473846 | RCD (30 mA), extendable | 1/10    |



#### Non-earthed socket outlet with center plate

16A/250V There are screwless terminals for each contact of the socket outlet. The socket outlet insert has shutters. The terminals are for max 2 rigid wires. No X-terminals. Can only be installed in dry indoor spaces.

| Type        | EAN           | Description   | Package |
|-------------|---------------|---|---------|
| 23-01UC-212 | 6410025060110 | Socket outlet, Jussi, non-earthed, 1-gang, shuttered, screw terminals | 10/100  |

## Tele & data



**Telephone outlet, Sweden**  
Swedish telephone socket outlet.

| Type     | EAN           | Description                             | Package |
|----------|---------------|---|---------|
| FOT1006  | 6418677305849 | Telephone outlet, Jussi, Swedish        | 1/10    |
| 2507-214 | 6418677327247 | Center plate, Jussi, telephone, Swedish | 10      |



**RJ45 outlet with sliding dust covers**  
The RJ45 inserts and center plate are made for 2 connectors. The connectors are not included. The connectors CEL30.UX are not compatible with this device, due to its integrated dust covers.

| Type                | EAN           | Description                                    | Package |
|---------------------|---------------|--|---------|
| <b>Insert</b>       |               |  |         |
| 1819.01             | 6418677330445 | Supporting frame insert for 2 x RJ45, Keystone | 10/100  |
| 1819.02             | 6418677330452 | Supporting frame insert for 2 x RJ45, AMP      | 10/100  |
| 1819.03             | 6418677330469 | Supporting frame insert for 2 x RJ45, Actassi  | 10/100  |
| 1819.04             | 6418677335945 | Supporting frame insert for 2 x RJ45, Systimax | 10/100  |
| <b>Center plate</b> |               |  |         |
| 1819DC-214          | 6438199002804 | Center plate, Jussi, 2 x RJ45, dust covers     | 10/100  |



**RJ45 outlet**  
Insert and center plate for two RJ45 connectors. Blind covers included. RJ45 connectors are not included.

| Type    | EAN           | Description   | Package |
|---------|---------------|---|---------|
| FOT5000 | 6410072040509 | Tele outlet, Jussi, for 2 x RJ45, connectors not included, Keystone | 20/200  |
| FOT5010 | 6410072040516 | Tele outlet, Jussi, for 2 x RJ45, connectors not included, AMP      | 20/200  |
| FOT5020 | 6418677328558 | Tele outlet, Jussi, for 2 x RJ45, connectors not included, Actassi  | 20/200  |
| FOT5030 | 6418677335921 | Tele outlet, Jussi, for 2 x RJ45, connectors not included, Systimax | 20/200  |



**RJ45 outlet, for 100 mm frames**  
Insert and center plate for two RJ45 connectors. Blind covers included. RJ45 connectors are not included. Use with 100 mm cover frames.

| Type        | EAN           | Description   | Package |
|-------------|---------------|---|---------|
| FOT5000-100 | 6418677328565 | Tele outlet, Jussi, for 2 x RJ45, 100 mm, connectors not included, Keystone | 20/200  |
| FOT5010-100 | 6418677328572 | Tele outlet, Jussi, for 2 x RJ45, 100 mm, connectors not included, AMP      | 20/200  |
| FOT5020-100 | 6418677328589 | Tele outlet, Jussi, for 2 x RJ45, 100 mm, connectors not included, Actassi  | 20/200  |
| FOT5030-100 | 6418677335938 | Tele outlet, Jussi, for 2 x RJ45, 100 mm, connectors not included, Systimax | 20/200  |



**RJ45 outlet including connectors**  
RJ45 outlet including RJ45 connectors manufactured by 3M. The dust covers are integrated into the connector. A blind cover is included for an empty connector hole. No special connecting tool is needed.

| Type    | EAN           | Description                     | Package |
|---------|---------------|---------------------------------|---------|
| FOT6208 | 6418677326493 | Tele outlet, 2 x RJ45, Cat6 UTP | 1/10    |

**RJ45 connector**

Unshielded (UTP) RJ45 connectors with Keystone fixing and A/B coupling. No special connecting tool is needed. The dust covers are integrated into the connectors. The connector is manufactured by 3M.

| Type     | EAN           | Description                       | Package |
|----------|---------------|-----------------------------------|---------|
| CEL30.U6 | 6418677326486 | Connector, RJ45, Cat6, UTP, white | 10/100  |

**Center plate for antenna outlets**

Suitable as center plate for antenna outlet inserts according to SFS 2706.



| Type | EAN           | Description                        | Package |
|------|---------------|------------------------------------|---------|
| 2531 | 6410070605700 | Center plate, Jussi, antenna, TV-R | 20/200  |

**Center plate for antenna outlets 100 mm frames**

Suitable as center plate for antenna socket outlet inserts according to SFS 2706. Prefabricated hole for satellite outlet. Compatible with 100 mm cover frames.



| Type     | EAN           | Description   | Package |
|----------|---------------|---|---------|
| 2531-100 | 6418677328541 | Center plate, Jussi, antenna, TV-R-Sat, for 100 mm cover frames | 20/200  |

**Center plate for satellite antenna outlets**

For antenna outlet inserts with satellite connector.



| Type        | EAN           | Description                            | Package |
|-------------|---------------|--|---------|
| 1743-03-214 | 6410070605717 | Center plate, Jussi, antenna, TV-R-Sat | 1/10    |

**Telephone outlet, Finland**

Finnish telephone outlet. The insert is 5-pole with screw terminals. The center plate is 3/5-pole. The insert and the center plate are sold separately.



| Type    | EAN           | Description   | Package |
|---------|---------------|---|---------|
| FOT1005 | 6410070440103 | Telephone outlet insert, Jussi, 3/5-pole Finnish                        | 10/100  |
| 2535    | 6410070609708 | Center plate, Jussi, telephone, Finnish                                 | 20/200  |
| FLK1010 | 6410070055017 | Surface mounting frame, Jussi, for telephone outlet and signal products | 10/100  |

**DKS-center plate**

DKS-center plate is used to fix many different kind of tele connectors into the mounting box. To be fitted with a suitable adapter 18XXEB.X.



| Type     | EAN           | Description                         | Package |
|----------|---------------|-------------------------------------|---------|
| 1758-214 | 6410072040424 | DKS center plate, Jussi, DKS-system | 10/100  |

**DKS-adapter with VGA connector**

Suitable for DKS-center plate 1758-214. VGA connector is included (15pin D-sub). Cable should be connected by soldering.



| Type       | EAN           | Description   | Package |
|------------|---------------|---|---------|
| 1850EB.VGA | 6418677334375 | Tele outlet for DKS-system with VGA display connector | 1/10    |

**DKS-adapter with Composite-/S-video connectors**

Suitable for DKS-center plate 1758-214. Composite video (BNC) and S-video (Mini DIN) connectors are included. Composite video connectors internal coaxial cable should be terminated by BNC-type connector. S-video internal cable is standard twisted-pair cable with toolless connections.



| Type       | EAN           | Description  | Package |
|------------|---------------|--|---------|
| 1875EB.YCV | 6418677334351 | Tele outlet for DKS-system with Composite-video and S-video connectors | 1/10    |



**DKS-adapter with Speakon connector**

Suitable for DKS-center plate 1758-214. Speakon 4 pin audio connector is included.

| Type       | EAN           | Description   | Package |
|------------|---------------|---|---------|
| 1876EB.SPE | 6418677334368 | Tele outlet for DKS-system with Speakon audio connector | 1/10    |



**DKS-adapters**

Different adapters for DKS-system. Suitable for DKS-center plate 1758-xx.

| Type          | EAN           | Description   | Package |
|---------------|---------------|---|---------|
| <b>RJ45</b>   |               |   |         |
| 1867EB        | 4011395182802 | Adapter for DKS-system, 2 x RJ45, Keystone                    | 10/100  |
| 1875EB        | 4011395776902 | Adapter for DKS-system, 2 x RJ45, AMP                         | 10/100  |
| 1872EB        | 4011395540800 | Adapter for DKS-system, 2 x RJ45, Systimax                    | 10/100  |
| <b>Fiber</b>  |               |   |         |
| 1870EB        | 4011395454107 | Adapter for DKS-system, fiber 2 x Simplex ST                  | 10/100  |
| 1874EB        | 4011395734902 | Adapter for DKS-system, fiber 2 x SCD                         | 10/100  |
| <b>Audio</b>  |               |   |         |
| 1853EB        | 4011395181409 | Adapter for DKS-system, XLR audio connector type FP           | 10/100  |
| 1854EB        | 4011395181508 | Adapter for DKS-system, XLR audio connector type MP           | 10/100  |
| 1876EB        | 4011395022566 | Adapter for DKS-system, XLR D-type or Speakon audio connector | 10/100  |
| <b>Others</b> |               |   |         |
| 1850EB        | 6438100605308 | Adapter for DKS-system, D-type 9-pin connector                | 10/100  |
| 1855EB        | 4011395181607 | Adapter for DKS-system, 2 x BNC/TNC, 9,8 mm                   | 10/100  |
| 1857EB        | 6418677329975 | Adapter for DKS-system, 2 x BNC/TNC, 12,9 mm                  | 10/100  |
| 1869EB        | 4011395183007 | Adapter for DKS-system, blank                                 | 10/100  |



**USB charger**

For supply and support of two mobile devices via USB-cable. With two USB A-type connectors. With electronic short-circuit and overload protection. Rated voltage: 230 V~/5 V-, 50 Hz - 60 Hz, power dissipation 0.3W. Suitable for: In case one output is used rated current max 1400 mA. In case two output are used rated current max 700 mA.

| Type                                 | EAN           | Description  | Package |
|--------------------------------------|---------------|--|---------|
| <b>Insert: Delivery time 3 weeks</b> |               |  |         |
| 6472U                                | 4011395151594 | Tele outlet insert, USB charging station 2 x 0.7 A | 1       |
| <b>Center plate</b>                  |               |  |         |
| 2539-214                             | 6418677331343 | Center plate, Jussi, for tele outlet               | 1/10    |



**Tele outlet USB**

Tele outlet with USB A-type connector. Compatible up to USB 2.0 versions. Internal connections with screw type terminals.

| Type                                 | EAN           | Description                                   | Package |
|--------------------------------------|---------------|---|---------|
| <b>Insert: Delivery time 3 weeks</b> |               |   |         |
| 0261/13                              | 4011395167557 | Tele outlet insert, with USB A-type connector | 1       |
| <b>Center plate</b>                  |               |   |         |
| 2539-214                             | 6418677331343 | Center plate, Jussi, for tele outlet          | 1/10    |



**Tele outlet VGA**

Tele outlet for VGA display with D-sub 15pin connector. Internal connections with screw type terminals.

| Type                                 | EAN           | Description  | Package |
|--------------------------------------|---------------|--|---------|
| <b>Insert: Delivery time 3 weeks</b> |               |  |         |
| 0261/23                              | 4011395167618 | Tele outlet insert, with VGA 15pin D-sub connector | 1       |
| <b>Center plate</b>                  |               |  |         |
| 2539-214                             | 6418677331343 | Center plate, Jussi, for tele outlet               | 1/10    |

**Tele outlet HDMI**

Tele outlet for HDMI display with A-type connector. Internal connections with screw type terminals.

| Type                                 | EAN           | Description                                    | Package |
|--------------------------------------|---------------|--|---------|
| <b>Insert: Delivery time 3 weeks</b> |               |  |         |
| 0261/33                              | 4011395167670 | Tele outlet insert, with HDMI A-type connector | 1       |
| <b>Center plate</b>                  |               |  |         |
| 2539-214                             | 6418677331343 | Center plate, Jussi, for tele outlet           | 1/10    |

**Tele outlet BNC-F**

Tele outlet for 1 or 2 BNC-F type connectors. Mounting hole for a connector is 12 mm. The insert and the connectors are sold separately.

| Type   | EAN           | Description                                      | Package |
|--|---------------|--|---------|
| <b>Insert and connector: Delivery time 3 weeks</b> |               |  |         |
| 0262/13  | 4011395167731 | Tele outlet insert for 2 x BNC-F type connectors | 1       |
| 0262   | 4011395167748 | Connector, BNC-F type, d = 12 mm                 | 1       |
| <b>Center plate</b>                                |               |  |         |
| 2539-214   | 6418677331343 | Center plate, Jussi, for tele outlet             | 1/10    |

**Tele outlet RCA**

Tele outlet for 1 or 2 RCA audio/video connectors. The insert and the connectors are sold separately.

| Type  | EAN           | Description                               | Package |
|---|---------------|---|---------|
| <b>Insert and connectors: Delivery time 3 weeks</b> |               |   |         |
| 0263/13   | 4011395167816 | Tele outlet insert for 2 x RCA connectors | 1       |
| 0263/04   | 4011395167861 | Connector, RCA white                      | 1       |
| 0263/05   | 4011395167878 | Connector, RCA black                      | 1       |
| 0263/06   | 4011395167885 | Connector, RCA red                        | 1       |
| 0263/07   | 4011395167892 | Connector, RCA yellow                     | 1       |
| <b>Center plate</b>                                 |               |   |         |
| 2539-214  | 6418677331343 | Center plate, Jussi, for tele outlet      | 1/10    |

**Tele outlet for Mini Jack**

Tele outlet for 1 or 2 Mini Jack connectors. The insert and the connectors are sold separately.

| Type   | EAN           | Description                                     | Package |
|--|---------------|---|---------|
| <b>Insert and connector: Delivery time 3 weeks</b> |               |   |         |
| 0264/13  | 4011395167953 | Tele outlet insert for 2 x Mini Jack connectors | 1       |
| 0264   | 4011395167960 | Connector, Mini Jack 3,5 mm, stereo             | 1       |
| <b>Center plate</b>                                |               |   |         |
| 2539-214   | 6418677331343 | Center plate, Jussi, for tele outlet            | 1/10    |

**Speaker outlet, stereo**

There are plug in connectors for the speaker wires and screw terminals for max 10 mm<sup>2</sup> internal wires.

| Type     | EAN           | Description                          | Package |
|----------|---------------|--------------------------------------|---------|
| 0248.00  | 6418677331367 | Tele outlet insert, speaker, stereo  | 1/10    |
| 2539-214 | 6418677331343 | Center plate, Jussi, for tele outlet | 1/10    |





**Speaker outlet, mono**

There is one red and one black gold plated terminal screw for the speaker wires and screw terminals for max 10 mm<sup>2</sup> internal wires.

| Type     | EAN           | Description   | Package |
|----------|---------------|---|---------|
| 1819.LSP | 6418677334337 | Speaker insert, with terminal screws                            | 1/10    |
| 1819-214 | 6418677334344 | Center plate, Jussi, speaker/RJ45, for inserts 1819.xx/1819.LSP | 1/10    |



**Tele outlet 6,3 mm Jack**

Stereo Plug Terminal for 6,3 mm Jack Plug. It can be used in calling and alarm systems as a socket outlet, or as a headphone or loudspeaker terminal. Good marking possibilities.

| Type    | EAN           | Description                               | Package |
|---------|---------------|---|---------|
| FOT3103 | 6410070608633 | Stereo Plug Terminal for 6,3 mm Jack Plug | 1/10    |



**Fixing frame and center plate for D-sub**

Fixing frame and center plate for 25-pole D-connector. With adapter plate for 9 -and 15-pole D-connectors. Delivered without terminal.

| Type  | EAN           | Description   | Package |
|-------|---------------|---|---------|
| 2549  | 6410070602815 | Tele outlet, Jussi, 25pin D-connector, connector not included | 1/10    |
| PEL15 | 6410070602952 | Adapter plate for 9/15pin D-connector                         | 10/200  |



**Fixing frame and center plate for XLR-connectors**

Fixing frame and center plate for XLR / FP-serie connector. The connector is not included.

| Type     | EAN           | Description   | Package |
|----------|---------------|---|---------|
| 2553-214 | 6410070602785 | Tele outlet, Jussi, XLR audio connector, connector not included | 10      |



**Fixing frame and center plate, Ø 22,5 mm**

Fixing frame and center plate for devices assembled into 22,5 mm hole.

| Type     | EAN           | Description                      | Package |
|----------|---------------|----------------------------------|---------|
| 2533-214 | 6410070602860 | Tele outlet, Jussi, 22,5 mm hole | 10      |



**Equipotential outlet 2-gang**

Equipotential outlet 2-gang. Screw terminals for 1 x 6 mm<sup>2</sup> and 4 x 2,5 mm<sup>2</sup> wires. The product includes insert and center plate.

| Type       | EAN           | Description                         | Package |
|------------|---------------|-------------------------------------|---------|
| 2095UC-212 | 6410070602907 | Equipotential outlet, Jussi, 2-gang | 10/100  |



**Fixing frame and center plate, Ø 19 mm**

Fixing frame and center plate for devices assembled into 19 mm hole. E.g. for installation of potential compensation plug 70 602 91 or TWINAX connectors.

| Type     | EAN           | Description                    | Package |
|----------|---------------|--------------------------------|---------|
| 2534-212 | 6410070602853 | Tele outlet, Jussi, 19 mm hole | 10      |



**Equipotential outlet 1-gang, Ø 19 mm**

Equipotential connector for internal cabling up to 6 mm<sup>2</sup>. Connection by soldering or pressing with tool. Fits to the center plate 2534-212.

| Type       | EAN           | Description   | Package |
|------------|---------------|---|---------|
| 0471.00037 | 6410070602914 | Equipotential outlet, 1-gang connector for 2534-212 | 10/100  |

**Equipotential plug**

Suitable for potential equalization and to be used with potential equalization socket outlets. For a max. 6 mm<sup>2</sup> conductor. The conductor is connected by pressing or soldering.

| Type       | EAN           | Description                     | Package |
|------------|---------------|---------------------------------|---------|
| 0299.00032 | 6410070602921 | Plug for potential compensation | 10/100  |

## Cover frames and accessories

**Cover frames 85 mm, IP21**

Flush mounting frames for 1-gang devices. Flush mounting: On a smooth surface IP21, on a rough surface IP20.



| Type | EAN           | Description                       | Package |
|------|---------------|-----------------------------------|---------|
| 2511 | 6410021661113 | Cover frame, Jussi, 85 mm, 1-gang | 20/200  |
| 2512 | 6410021661120 | Cover frame, Jussi, 85 mm, 2-gang | 10/100  |
| 2513 | 6410021661137 | Cover frame, Jussi, 85 mm, 3-gang | 10/100  |
| 2514 | 6410021661144 | Cover frame, Jussi, 85 mm, 4-gang | 10/50   |
| 2515 | 6410021661151 | Cover frame, Jussi, 85 mm, 5-gang | 10/50   |

**Cover frames for combinations of double socket outlet 85 mm, IP21**

Flush mounting frames for one double socket outlet + 1-gang products. Flush mounting: On a smooth surface IP21, on a rough surface IP20.



| Type | EAN           | Description                         | Package |
|------|---------------|-------------------------------------|---------|
| 2521 | 6410021661618 | Cover frame, Jussi, 85 mm, 1+0-gang | 20/200  |
| 2522 | 6410021661625 | Cover frame, Jussi, 85 mm, 1+1-gang | 10/100  |
| 2523 | 6410021661632 | Cover frame, Jussi, 85 mm, 1+2-gang | 10/100  |
| 2524 | 6410021661649 | Cover frame, Jussi, 85 mm, 1+3-gang | 10/50   |
| 2525 | 6410021661656 | Cover frame, Jussi, 85 mm, 1+4-gang | 10/50   |

**Cover frames 100 mm for double socket outlets, IP21**

Flush mounting frames for double socket outlets. Also possible to install standard 85 mm 1-gang devices by using adapter 2519-100. Flush mounting: On a smooth surface IP21, on a rough surface IP20.



| Type     | EAN           | Description                        | Package |
|----------|---------------|------------------------------------|---------|
| 2521-100 | 6410021661212 | Cover frame, Jussi, 100 mm, 1-gang | 20/200  |
| 2522-100 | 6410021661229 | Cover frame, Jussi, 100 mm, 2-gang | 5/50    |
| 2523-100 | 6410021661236 | Cover frame, Jussi, 100 mm, 3-gang | 5/50    |
| 2524-100 | 6410021661243 | Cover frame, Jussi, 100 mm, 4-gang | 5/50    |
| 2525-100 | 6410021661250 | Cover frame, Jussi, 100 mm, 5-gang | 5/50    |

**Adapters**

Adapters are used to fit other accessories e.g. 48 x 48 mm and 50 x 50 mm devices to Jussi-frames and standard 85 mm devices to 100 mm cover frames.



| Type     | EAN           | Description  | Package |
|----------|---------------|--|---------|
| 2519-100 | 6410021661199 | Adapter, Jussi, 1/2-gang. for 85/100 mm cover frames | 5/50    |
| 2519     | 6410021660109 | Adapter, Jussi, for 48 x 48 mm center plates         | 10/100  |
| 1746-214 | 6410021660116 | Adapter, Jussi, for 50 x 50 mm center plates         | 10/100  |
| 2519-B55 | 6438199000442 | Adapter, Jussi center plate to Basic 55 cover plate  | 5/50    |

**Blind cover plates, IP21**

Used to cover empty flush mounting boxes. Flush mounting: On a smooth surface IP21, on a rough surface IP20.

| Type | EAN           | Description  | Package |
|------|---------------|--|---------|
| 2607 | 6410021660512 | Cover plate, Jussi, blind, 1-gang, clip-on fastening | 20/200  |
| 2608 | 6410021660529 | Cover plate, Jussi, blind, 2-gang, screw fastening   | 10/100  |

**Blind center plates, IP21**

100 mm blind center plate can be used to cover an empty box. Can be used together with 100 mm flush- and surface mounting frames. Flush mounting: On a smooth surface IP21, on a rough surface IP20 (seal can't be used). When installed on surface the protection class is IP44 if wires are installed downwards.

| Type         | EAN           | Description  | Package |
|--------------|---------------|--|---------|
| 2538-212     | 6410021660154 | Center plate, Jussi, blind 85 mm, screw fastening  | 20/200  |
| 2538-100-214 | 6418677335709 | Center plate, Jussi, blind 100 mm, screw fastening | 1/10    |

**Labeling plate**

Labeling plate for Jussi and Impressivo cover frames. Size of text area is max 12 x 52 mm.



| Type | EAN           | Description   | Package |
|------|---------------|---|---------|
| 2752 | 6438199000848 | Labeling plate for Jussi and Impressivo cover plates. | 10/100  |

**Claws**

Claws for 1-gang and Euro socket outlets, switches and push switches. Not suitable for double socket outlets 302.xx. Inserts with claws are also available.



| Type | EAN           | Description                           | Package |
|------|---------------|---------------------------------------|---------|
| ASE1 | 6410021660932 | Claws for socket outlets and switches | 10/100  |

**Impulse spring**

Impulse spring for ABB switches, 10 pcs in sales pack.



| Type   | EAN           | Description                             | Package |
|--------|---------------|---|---------|
| PJ4.10 | 6438199004808 | Impulse spring for ABB switches, 10 pcs | 10/100  |

## Jussi surface mounting IP20/IP21

### Surface mounting boxes and accessories



#### Floor installation housing

Product is usually mounted on the wall by the floor. When installing dimmers, the bottom of the housing need to be opened and further space is needed behind, a.g. flush mounting box. The lower part of the device housing can be used as a junction box, max 5 terminals.

| Type      | EAN           | Description  | Package |
|-----------|---------------|--|---------|
| 2511L     | 6438199004907 | Surface mounting box, Jussi, 85 mm, 1-gang, lath installation, white | 1/10    |
| 2551L-212 | 6410014027513 | Floor installation box, Jussi, for 1-gang devices                    | 5/50    |
| 2552L-212 | 6410014027520 | Floor installation box, Jussi, for 2-gang socket outlets             | 5/50    |



#### Corner box 85 mm

Surface mounting box for 2 devices, also for electronic devices. Horizontal or vertical installation in corners. Use with 85 mm 2-gang cover frame (2512).

| Type     | EAN           | Description   | Package |
|----------|---------------|---|---------|
| 2512H    | 6438199000602 | Surface mounting box, Jussi, corner installation, 85 mm, 2-gang                   | 1/20    |
| 2512H.13 | 6438199000671 | Surface mounting box, Jussi, corner installation, 85 mm, 2-gang, with cover frame | 1/20    |

#### Surface mounting frames 85 mm

Frame height 22 mm. Use with 85 mm cover frames.



| Type      | EAN           | Description  | Package |
|-----------|---------------|--|---------|
| 2511R-212 | 6410025161749 | Surface mounting frame, Jussi, 1-gang for 1-gang device, for 85 mm cover plates, h=22  | 10/100  |
| 2552R-212 | 6410025161725 | Surface mounting frame, Jussi, 2-gang for 1-gang devices, for 85 mm cover plates, h=22 | 10/100  |
| 2513R-214 | 6438199001999 | Surface mounting frame, Jussi, 3-gang for 1-gang devices, h=22                         | 1/5     |

#### Surface mounting frames 100 mm

Frame height 25 mm. Use with 100 mm cover frames.



| Type      | EAN           | Description  | Package |
|-----------|---------------|--|---------|
| 2521R-100 | 6418677328510 | Surface mounting frame, Jussi, for one double socket outlet, h=25    | 10/100  |
| 2522R-100 | 6418677331404 | Surface mounting frame, Jussi, for two double socket outlets, h=25   | 10/100  |
| 2523R-100 | 6418677331411 | Surface mounting frame, Jussi, for three double socket outlets, h=25 | 1/5     |

#### Surface mounting frame for double socket outlets

Frame height 22 mm. Use with double socket outlets 302EUJ.1 and 232EUJ.



| Type      | EAN           | Description  | Package |
|-----------|---------------|--|---------|
| 2551R-212 | 6410025161510 | Surface mounting frame, Jussi, for one double socket outlet 302EUJ.1 or 232EUJ | 10/100  |

#### Surface mounting frames

Frame height 36 mm. Use with 85 mm cover frames. One X-terminal included.



| Type         | EAN           | Description   | Package |
|--------------|---------------|---|---------|
| 2551-510-212 | 6410024065710 | Surface mounting frame, Jussi, 1-gang, for 85 mm cover plates, h=36 | 10/100  |
| 2552-510-212 | 6410024065727 | Surface mounting frame, Jussi, 2-gang, for 85 mm cover plates, h=36 | 5/50    |



**Surface mounting frame for signal devices**

For use in the installation of Jussi signal devices, push button boards and telephone socket outlets. Delivered with a supporting ring, which makes installation of the housing easier. Housing dimensions: 63 x 63 x 34.

| Type    | EAN           | Description   | Package |
|---------|---------------|---|---------|
| FLK1010 | 6410070055017 | Surface mounting frame, Jussi, for telephone outlet and signal products | 10/100  |

Surface mounting switches and push switches



**1-gang switches, IP21**

16AX/250 V, with screwless terminals, lamp possibility. Rocker with clip-on fastening. IP21 when wires are installed downwards.

| Type   | EAN           | Description                                      | Package |
|--------|---------------|--|---------|
| 1066A4 | 6418677307515 | 1-gang 2-way switch, Jussi, 2 X-terminals        | 10/100  |
| 1067A4 | 6418677307539 | 1-gang intermediate switch, Jussi, 2 X-terminals | 10/100  |



**2-gang 1-way switch, IP21**

16AX/250 V, with screwless terminals, no lamp possibility. Rocker with clip-on fastening. IP21 when wires are installed downwards.

| Type   | EAN           | Description                               | Package |
|--------|---------------|---|---------|
| 1065A4 | 6418677307461 | 2-gang 1-way switch, Jussi, 2 X-terminals | 10/100  |



**3-gang 1-way switch, IP21**

16AX/250 V, with screwless terminals, no lamp possibility. Rocker with clip-on fastening. IP21 when wires are installed downwards.

| Type    | EAN           | Description                                | Package |
|---------|---------------|--|---------|
| 10631A4 | 6418677307447 | 3-gang 1-way switch, Jussi, no X-terminals | 10/100  |



**1-gang 2-way push switch, IP21**

10A/250V, with screwless terminals, lamp possibility. Push switch includes an opening and closing contact terminal function. Rocker with clip-on fastening. Delivered with clear lens. IP21 when the wires are installed downwards.

| Type    | EAN           | Description  | Package |
|---------|---------------|--|---------|
| 1466AK4 | 6418677307560 | 1-gang 2-way push switch, Jussi, N-terminal, lens, lamp not included | 10/100  |



**Lamps for switches**

Lamps for switches. Lamps can be installed in 1-gang switch inserts that include the signal-/search light possibility. Lamps can't be installed to 2- or 3-gang switch inserts.

| Type  | EAN           | Description  | Package |
|-------|---------------|--|---------|
| 8370  | 6410021060701 | Lamp, 230 V/0.4 mA, fluorescent, for 1-gang switches | 10/100  |
| 8372  | 6410021060725 | Lamp, 230 V/2 mA, fluorescent, for 1-gang switches   | 10/100  |
| 8375  | 6410021060756 | Lamp, 24 V/22 mA, incandescent, for 1-gang switches  | 10/100  |
| 8376  | 6410021060763 | Lamp, 12 V/40 mA, incandescent, for 1-gang switches  | 10/100  |
| 8370R | 6438199004860 | Lamp, 250 V/0.4 mA, LED, for 1-gang switches         | 10/100  |
| 8375R | 6438199004877 | Lamp, 5-24 V/0.5-2.5 mA, LED, for 1-gang switches    | 10/100  |

## Surface mounting socket outlets

**4-gang Schuko socket outlet, IP21**

16 A/250 V. The device is based on two 2-gang socket outlet inserts, which are internally connected. The socket outlet inserts have shutters. There are screwless terminals for each contact of the socket outlet insert for max 4 rigid wires. No X-terminals. IP21 when the wires are installed downwards.

| Type  | EAN           | Description  | Package |
|-------|---------------|--|---------|
| 404EA | 6418677335822 | Socket outlet, Jussi, Schuko, 4-gang, shuttered, screwless terminals | 1/20    |

**2-gang Schuko socket outlet, IP21**

16 A/250 V. 402EA has screwless terminals for each contact of the socket outlet for max 4 rigid wires. No X-terminals. 232EA has screw terminals for max 2 wires. 2 X-terminals. The socket outlet insert has shutters. An installation plate is delivered with the socket outlets, for easier installation. Installation is also possible on conductive surfaces with the installation plate. IP21 when the wires are installed downwards.

| Type  | EAN           | Description  | Package |
|-------|---------------|--|---------|
| 402EA | 6418677335815 | Socket outlet, Jussi, Schuko, 2-gang, shuttered, screwless terminals | 10/100  |
| 232EA | 6410024061217 | Socket outlet, Jussi, Schuko, 2-gang, shuttered, screw terminals     | 10/100  |

**2-gang brown Schuko socket outlet, IP21**

16 A/250 V. This socket outlet has screwless terminals for each contact of the socket outlet for max 4 rigid wires. No X-terminals. The socket outlet insert has shutters. An installation plate is delivered with the socket outlets, for easier installation. Installation is also possible on conductive surfaces with the installation plate. IP21 when the wires are installed downwards. Colour RAL8028.

| Type     | EAN           | Description  | Package |
|----------|---------------|--|---------|
| 402EA-01 | 6438199002774 | Socket outlet, Jussi, Schuko, 2-gang, screwless terminals, brown | 10/100  |

**2-gang Schuko socket outlet, IP21**

Screwless terminals for each contact of the socket outlet for max 4 rigid wires. No X-terminals. The socket outlet insert has shutters. IP21 when the wires are installed downwards.

| Type  | EAN           | Description  | Package |
|-------|---------------|--|---------|
| 402EL | 6438199004914 | Socket outlet, Jussi, Schuko, 2-gang, shuttered, screwless terminals, lath installation, white | 1/10    |

**2-gang Schuko socket outlet, corner installation, IP21**

16 A/250 V. Schuko 2-gang socket outlet for corner installation. There are screwless terminals for each contact of the socket outlet for max 4 rigid wires. No X-terminals. The socket outlet insert has shutters.

| Type    | EAN           | Description   | Package |
|---------|---------------|---|---------|
| 402EA.E | 6438199000619 | Socket outlet, Jussi, Schuko, 2-gang, shuttered, screwless terminals, corner installation | 1/20    |

**1-gang Schuko socket outlet, IP21**

16 A/250 V. There are screwless terminals for each contact of the socket outlet. The socket outlet insert has shutters. The terminals are for max 2 rigid wires. No X-terminals. An installation plate is delivered with the socket outlets, for easier installation. Installation is also possible on conductive surfaces with the installation plate. IP21 when the wires are installed downwards.

| Type   | EAN           | Description  | Package |
|--------|---------------|--|---------|
| 20EAKS | 6410024061316 | Socket outlet, Jussi, Schuko, 1-gang, shuttered, screwless terminals | 10/100  |
| 23EAKS | 6410024061118 | Socket outlet, Jussi, Schuko, 1-gang, shuttered, screw terminals     | 10/100  |



**2-gang Schuko socket outlet in floor installation housing**

Floor box incl. 2-gang socket outlet, shuttered, screwless terminals

| Type     | EAN           | Description  | Package |
|----------|---------------|--|---------|
| 302EUC1L | 6418677328534 | Socket outlet, Jussi, Schuko, 2-gang, floor installation | 5/50    |

**Jussi surface mounting IP44/IP55**

Switches, push switches and signal lights



**1-gang switches, IP44**

16AX/250V, with screwless terminals. The terminals are for max 2 rigid wires. One extra screw terminal inside the box for extending one wire. Signal light possibility. Delivered with white and clear lens but without lamp.

| Type   | EAN           | Description  | Package |
|--------|---------------|--|---------|
| 1066SW | 6418677334559 | 1-gang 2-way switch, Jussi IP44, 2 X-terminals, lamp not included        | 10/100  |
| 1067SW | 6418677334566 | 1-gang intermediate switch, Jussi IP44, 2 X-terminals, lamp not included | 1/10    |



**2-pole switch, IP44**

16AX/250V, with screwless terminals. The terminals are for max 2 rigid wires. One extra screw terminal inside the box for extending one wire. Signal light possibility. Delivered without lamp.

| Type   | EAN           | Description  | Package |
|--------|---------------|--|---------|
| 1062SW | 6418677334535 | 2-pole 1-gang 1-way switch, Jussi IP44, 2 X-terminals, lens, "1/0" symbol, lamp not included | 1/10    |



**2-gang switch, IP44**

16AX/250V, with screwless terminals. The terminals are for max 2 rigid wires. One extra screw terminal inside the box for extending one wire. No signal light possibility.

| Type   | EAN           | Description                                    | Package |
|--------|---------------|--|---------|
| 1065SW | 6418677334542 | 2-gang 1-way switch, Jussi IP44, 2 X-terminals | 10/100  |



**1-gang 2-way push switch, IP44**

10A/250V, with screwless terminals. The terminals are for max 2 rigid wires. One extra screw terminal inside the box for extending one wire. Signal light possibility. Delivered with white and clear lens but without lamp.

| Type   | EAN           | Description   | Package |
|--------|---------------|---|---------|
| 1466SW | 6418677334573 | 1-gang 2-way push switch, Jussi IP44, N-terminal, lamp not included | 10/100  |

**Lamps for switches**

Lamps for switches. Lamps can be installed in 1-gang switch inserts that include the signal-/search light possibility. Lamps can't be installed to 2- or 3-gang switch inserts.



| Type  | EAN           | Description  | Package |
|-------|---------------|--|---------|
| 8370  | 6410021060701 | Lamp, 230 V/0.4 mA, fluorescent, for 1-gang switches | 10/100  |
| 8372  | 6410021060725 | Lamp, 230 V/2 mA, fluorescent, for 1-gang switches   | 10/100  |
| 8375  | 6410021060756 | Lamp, 24 V/22 mA, incandescent, for 1-gang switches  | 10/100  |
| 8376  | 6410021060763 | Lamp, 12 V/40 mA, incandescent, for 1-gang switches  | 10/100  |
| 8370R | 6438199004860 | Lamp, 250 V/0.4 mA, LED, for 1-gang switches         | 10/100  |
| 8375R | 6438199004877 | Lamp, 5-24 V/0.5-2.5 mA, LED, for 1-gang switches    | 10/100  |

**Signal light, IP55**

Red LED signal light 230 V/25 mA. Screw terminals for rigid wires. One extra screw terminal inside the box for extending/closure of one wire.

| Type      | EAN           | Description                                   | Package |
|-----------|---------------|---|---------|
| 2661SW-12 | 6418677335143 | Signal light, Jussi IP55, Led 230V/25 mA, red | 10/100  |

**Cable entry**

Thermoplastic cable entries for Jussi IP44/IP55 surface mounting products. Cable entry can be used for fitting 2 accessories.

| Type   | EAN           | Description  | Package |
|--------|---------------|--|---------|
| 2124SW | 6418677335884 | Cable entry for Jussi IP44/IP55 products, 1-way                              | 5/50    |
| 2125SW | 6418677335891 | Cable entry for Jussi IP44/IP55 products, 2-way                              | 5/50    |
| 2138SW | 6418677334610 | Cable entry for fitting Jussi IP44/IP55 products                             | 5/50    |
| 1237SW | 6418677335952 | Cable entry to the bottom for Jussi IP44/IP55 products, 1-way, round 16,5 mm | 5/50    |

## Socket outlets

**2-gang Schuko socket outlet, flush mounting, IP44**

16 A/250 V There are screwless terminals for each contact of the socket outlet for max 4 rigid wires. No X-terminals. The socket outlet insert has shutters.

| Type   | EAN           | Description  | Package |
|--------|---------------|--|---------|
| 302EUG | 6418677331398 | Socket outlet, Jussi IP44, Schuko, 2-gang, shuttered, screwless terminals, branching terminals | 10/100  |

**2-gang Schuko socket outlet, surface mounting, IP54/IP55**

16 A/250 V There are screwless terminals for each contact of the socket outlet for max 4 rigid wires. The socket outlet insert has shutters.

| Type   | EAN           | Description  | Package |
|--------|---------------|--|---------|
| 402ESW | 6418677334580 | Socket outlet, Jussi IP54/55, 2-gang Schuko, shuttered, screwless terminals, branching terminals | 10/100  |

**2-gang Schuko socket outlet, surface mounting, IP54/IP55**

16 A/250 V. There are screw terminals for each contact of the socket outlet and 2 X-terminals. The socket outlet insert has shutters. The terminals are for max 2 rigid wires. IP55 tested with hinged lids closed.

| Type   | EAN           | Description   | Package |
|--------|---------------|---|---------|
| 232EWS | 6410024065239 | Socket outlet, Jussi IP54/55, 2-gang Schuko, shuttered, screw terminals, branching terminals, 2 X-terminals | 10/100  |

**1-gang Schuko socket outlet, surface mounting, IP54/IP55**

16 A/250 V There are terminals for each contact of the socket outlet. The socket outlet insert has shutters. The terminals are for max 2 rigid wires. Inside the box there is one extra screw terminal for extending one wire. IP55 tested with hinged lid closed.

| Type  | EAN           | Description   | Package |
|-------|---------------|---|---------|
| 20ESW | 6418677334603 | Socket outlet, Jussi IP54/55, 1-gang Schuko, shuttered, screwless terminals | 10/100  |





#### Socket outlet with residual current device, IP44

230 V, 16 A, IP44, with A-type built-in residual current device (RCD), tripping current 30 mA. The socket outlet insert has shutters. Approved for extending a branch circuit, but only regular sockets connected to protected outlet wires are protected. Do not use the cellular-plastic seal in surface mounting.

| Type         | EAN           | Description   | Package |
|--------------|---------------|---|---------|
| 3120EUG-44.2 | 7612271473860 | Socket residual current device, 30 mA, A-type   | 1/10    |
| 3120EUG-44   | 7612271473884 | Socket outlet, IP44, Schuko, 1-gang with RCD (30 mA), shuttered, extendable, flush mounting | 1/10    |

#### Cable entry

Thermoplastic cable entries for Jussi IP44/IP55 surface mounting products. Cable entry can be used for fitting 2 accessories.



| Type   | EAN           | Description  | Package |
|--------|---------------|--|---------|
| 2124SW | 6418677335884 | Cable entry for Jussi IP44/IP55 products, 1-way                              | 5/50    |
| 2125SW | 6418677335891 | Cable entry for Jussi IP44/IP55 products, 2-way                              | 5/50    |
| 2138SW | 6418677334610 | Cable entry for fitting Jussi IP44/IP55 products                             | 5/50    |
| 1237SW | 6418677335952 | Cable entry to the bottom for Jussi IP44/IP55 products, 1-way, round 16,5 mm | 5/50    |



**03**

## **Electronics**

**Taking comfort, safety and sustainability to the next level.**



# — Electronics

|                   |    |
|-------------------|----|
| Dimmer            | 62 |
| Motion detectors  | 66 |
| Thermostats       | 67 |
| Motor controllers | 67 |
| Audio             | 68 |
| Timers            | 69 |
| RF-products       | 70 |





---

## Convenient and efficient electronics

Jussi and Impressivo electronics solutions improve comfort, safety, and sustainability in everyday life. The assortment includes for example dimmers, timers, motion sensors, presence detectors, thermostats, motor controllers and audio products.

—  
01



—  
01

**Illustration in original size**  
The cover frame measures 85 mm x 85 mm (w x h).

## Dimmers



### Flat LED-dimmer, with rotary control

Rotary control dimmer for LED lamps. Via mode switch adjustable between leading edge control (RL) or trailing edge control (RC). 2-wire connection (N-wire not needed). Nominal power: 2-100 VA or 10-400W(details in manual). Linear and low-noise operation. Mixed loads allowed. Electronic short-circuit and overload protection. Adjustable minimum brightness. Also applicable for 1-gang 2-way installations. Nominal voltage 230 V/50-60 Hz. Maximum 20 LED lamps behind one dimmer. Compatibility with defined Philips LED lamps is guaranteed.

#### Note!

There might be limitations from transformer producers on how many dimmable LED bulbs can be connected behind one transformer.

| Type  | EAN           | Description   | Package |
|---|---------------|---|---------|
| 6523URJGL-214-103                           | 4011395232118 | LED dimmer, rotary 2-100 VA, with neon lamp, Jussi      | 1/10    |
| 6523URCGL-84-103                            | 4011395232125 | LED dimmer, rotary 2-100 VA, with neon lamp, Impressivo | 1/10    |
| 6523UR-103-500                              | 4011395232101 | LED dimmer, rotary 2-100 VA, insert with neon lamp      | 1/10    |
| 6540-84-102-510                             | 4011395265789 | Dimmer center plate, neon lamp included, white          | 1/10    |
| 6540-83-102-510                             | 4011395265772 | Dimmer center plate, neon lamp included, aluminium      | 1/10    |
| 6540-81-102-510                             | 4011395265765 | Dimmer center plate, neon lamp included, anthracite     | 1/10    |
| <b>Design series. Delivery time to ask.</b> |               |   |         |
| 6540-866-102                                | 4011395125496 | Dimmer center plate, neon lamp included, steel          | 1/10    |
| 6540-884-102                                | 4011395129425 | Dimmer center plate, neon lamp included, white matt     | 1/10    |
| 6540-885-102                                | 4011395129487 | Dimmer center plate, neon lamp included, black matt     | 1/10    |



### LED-dimmer, with rotary control

Rotary control dimmer for LED lamps. Via mode switch adjustable between leading edge control (RL) or trailing edge control (RC). 2-wire connection (N-wire not needed). Nominal power: 2-100 W/VA (retrofit LED loads). Nominal power: 10 - 250 W/VA (non-LED loads). Linear and low-noise operation. Mixed loads allowed. Electronic short-circuit and overload protection. Adjustable minimum brightness. Also applicable for 1-gang 2-way installations. Nominal voltage 230 V/50-60 Hz. Maximum 20 LED lamps behind one dimmer. Compatibility with defined Philips LED lamps is guaranteed.

#### Note!

There might be limitations from transformer producers on how many dimmable LED bulbs can be connected behind one transformer.

| Type  | EAN           | Description   | Package |
|---|---------------|---|---------|
| <b>Impressivo (incl. insert and center plate)</b> |               |   |         |
| 6523U-102-500                                     | 4011395151310 | LED dimmer insert, rotary 2-100 VA                          | 1/10    |
| 2117C-214   | 6438199003887 | Center plate, rotary button and nut                         | 1/20    |
| 6540-84-102-510                                   | 4011395265789 |   | 1/10    |
| 6540-83-102-510                                   | 4011395265772 | Impressivo, with rotary knob, with indication lamp          | 1/10    |
| 6540-81-102-510                                   | 4011395265765 | Dimmer center plate, Impressivo, anthracite, with neon lamp | 1/10    |
| <b>Design series. Delivery time to ask.</b>       |               |   |         |
| 6540-866-102                                      | 4011395125496 | Dimmer center plate, neon lamp included, steel              | 1/10    |
| 6540-884-102                                      | 4011395129425 | Dimmer center plate, neon lamp included, white matt         | 1/10    |
| 6540-885-102                                      | 4011395129487 | Dimmer center plate, neon lamp included, black matt         | 1/10    |

**DALI-potentiometers**

For DALI broadcast service (via central telegram) according standard IEC 62386.

For switching and dimming up to 64 DALI- devices like electronic ballasts and transformers with DALI-interface.

With (2117/11U-500) or without (2117U-500) power supply. No center plate or frame included.

| Type  | EAN           | Description   | Package |
|---|---------------|---|---------|
| <b>Inserts</b>                              |               |   |         |
| 2117U-500                                   | 4011395152218 | DALI potentiometer insert                           | 1/10    |
| 2117/11U-500                                | 4011395152225 | With integrated power supply                        | 1/10    |
| <b>Center plates</b>                        |               |   |         |
| 2115/11-214-500                             | 4011395265758 |   | 1/10    |
| 6540-84-102-510                             | 4011395265789 | Dimmer center plate, neon lamp included, white      | 1/10    |
| 6540-83-102-510                             | 4011395265772 | Dimmer center plate, neon lamp included, aluminium  | 1/10    |
| 6540-81-102-510                             | 4011395265765 | Dimmer center plate, neon lamp included, anthracite | 1/10    |
| <b>Design series. Delivery time to ask.</b> |               |   |         |
| 6540-866-102                                | 4011395125496 | Dimmer center plate, neon lamp included, steel      | 1/10    |
| 6540-884-102                                | 4011395129425 | Dimmer center plate, neon lamp included, white matt | 1/10    |
| 6540-885-102                                | 4011395129487 | Dimmer center plate, neon lamp included, black matt | 1/10    |

**230 V Rotation dimmer for incandescent- and halogen lamps**

230 V dimmer for incandescent- and halogen lamps. Push switch function, change over contact. Nominal voltage:

230 V/50 Hz. Fuse T3,15 A/250 V.

| Type  | EAN           | Description   | Package |
|---|---------------|---|---------|
| <b>Jussi (incl. insert, center plate and cover frame)</b> |               |   |         |
| 2210UJ-214  | 6410035126004 | Dimmer 60-400 VA, one-pole rotary switch, incandescent lamp, fuse T1,6H/250 V, Jussi              | 1/10    |
| 2250UJGL-214  | 6410035126035 | Dimmer 60-600 VA, push switch with change-over contact, with neon lamp, fuse T3,15 H/250 V, Jussi | 1/10    |
| <b>Impressivo (sold in parts)</b>                         |               |   |         |
| 2250U   | 4011395365205 | Dimmer, 60-600 VA, insert   | 1/10    |
| 6540-84-102-510   | 4011395265789 | Dimmer center plate, neon lamp included, white  | 1/10    |
| 6540-83-102-510   | 4011395265772 | Dimmer center plate, neon lamp included, aluminium  | 1/10    |
| 6540-81-102-510   | 4011395265765 | Dimmer center plate, neon lamp included, anthracite   | 1/10    |
| <b>Design series. Delivery time to ask.</b>               |               |   |         |
| 6540-866-102  | 4011395125496 | Dimmer center plate, neon lamp included, steel  | 1/10    |
| 6540-884-102  | 4011395129425 | Dimmer center plate, neon lamp included, white matt   | 1/10    |
| 6540-885-102  | 4011395129487 | Dimmer center plate, neon lamp included, black matt   | 1/10    |



#### Dimmer for electronic halogen transformers

Dimmer for electronic halogen transformers. Push switch function, change over contact. Nominal voltage: 230 V / 50 Hz. Electronic short circuit- and overload protection. Suitable also for 230V incandescent- and halogen lamps.

| Type  | EAN           | Description   | Package |
|---|---------------|---|---------|
| <b>Jussi (incl. insert, center plate and cover frame)</b> |               |   |         |
| 6513UJGL-214  | 6410035127858 | El. transformer dimmer 40-420 VA, Jussi                   | 1/10    |
| 6514UJ-214-501  | 4011395122778 | Dimmer, 2-pole, 420 W/VA, Jussi                           | 1/10    |
| <b>Impressivo (incl. insert and center plate)</b>         |               |   |         |
| 6513UJGL-84-102   | 4011395265680 |   | 1/10    |
| <b>Impressivo (sold in parts)</b>                         |               |   |         |
| 6513U-102   | 4011395631003 | El. transformer dimmer insert, 40-420 VA.                 | 1/10    |
| 6544-84-501   | 4011395122815 | Dimmer center plate, Impressivo, white, "0" marking.      | 1/10    |
| 6544-81-501   | 4011395122785 | Dimmer center plate, Impressivo, anthracite, "0" marking. | 1/10    |
| 6544-83-501   | 4011395122792 | Dimmer center plate, Impressivo, aluminum, "0" marking.   | 1/10    |
| 6540-84-102-510   | 4011395265789 | Dimmer center plate, neon lamp included, white            | 1/10    |
| 6540-83-102-510   | 4011395265772 | Dimmer center plate, neon lamp included, aluminium        | 1/10    |
| 6540-81-102-510   | 4011395265765 | Dimmer center plate, neon lamp included, anthracite       | 1/10    |
| <b>Design series. Delivery time to ask.</b>               |               |   |         |
| 6540-866-102  | 4011395125496 | Dimmer center plate, neon lamp included, steel            | 1/10    |
| 6540-884-102  | 4011395129425 | Dimmer center plate, neon lamp included, white matt       | 1/10    |
| 6540-885-102  | 4011395129487 | Dimmer center plate, neon lamp included, black matt       | 1/10    |



#### Potentiometer 1-10 V

Potentiometer 1-10 V. For controlling electronic control gears for fluorescent lamps, analogy adjustment (IEC 929). Nominal voltage: 230 V/50 Hz. Control current max. 50 mA DC. Switching capability 4 A cos  $\phi$  0,9. Up to 4 control gears can be directly connected to 1 dimmer. With larger loads an external relay or contactor must be used.

| Type  | EAN           | Description   | Package |
|---|---------------|---|---------|
| <b>Jussi (incl. insert, center plate and cover frame)</b> |               |   |         |
| 2112UJ-214-510  | 6410035127919 | Potentiometer 1-10 V, Jussi                         | 1/10    |
| <b>IMPRESSIVO (inc. insert and center plate)</b>          |               |   |         |
| 2112UJGL-84-101   | 4011395265697 |   | 1/10    |
| <b>Impressivo (sold in parts)</b>                         |               |   |         |
| 2112U-101   | 4011395463802 | Potentiometer insert 1-10 V                         | 1/10    |
| 6540-84-102-510   | 4011395265789 | Dimmer center plate, neon lamp included, white      | 1/10    |
| 6540-83-102-510   | 4011395265772 | Dimmer center plate, neon lamp included, aluminium  | 1/10    |
| 6540-81-102-510   | 4011395265765 | Dimmer center plate, neon lamp included, anthracite | 1/10    |
| <b>Design series. Delivery time to ask.</b>               |               |   |         |
| 6540-866-102  | 4011395125496 | Dimmer center plate, neon lamp included, steel      | 1/10    |
| 6540-884-102  | 4011395129425 | Dimmer center plate, neon lamp included, white matt | 1/10    |
| 6540-885-102  | 4011395129487 | Dimmer center plate, neon lamp included, black matt | 1/10    |



**LED-Touch Dimmer**

Touch dimmer for LED lamps. Leading and trailing edge control (RLC-type). 2-wire connection. Rated power 2 - 100 VA. Linear and low-noise operation. Mixed loads allowed. Electronic short-circuit and overload protection. Adjustable minimum brightness. Nominal voltage 230 V / 50-60 Hz. Also applicable for 1-gang 2-way installations. Operation also possible via conventional push buttons (Functions: on, off and dim). Maximum 20 LED lamps behind one dimmer. Compatibility with defined Philips LED lamps is guaranteed.

**Note!**

There might be limitations from transformer producers on how many dimmable LED bulbs can be connected behind one transformer

| Type  | EAN           | Description   | Package |
|---|---------------|---|---------|
| <b>Impressivo (sold in parts)</b>           |               |   |         |
| 6526U-500                                   | 4011395196045 | LED dimmer push button  | 1/10    |
| 6543-214-102-500                            | 4011395175804 |   | 1/10    |
| 6543-84-101                                 | 4011395996317 | Touch dimmer center plate, Impressivo, white, with neon lamp      | 1/10    |
| 6543-81-101                                 | 4011395056240 | Touch dimmer center plate, Impressivo, anthracite, with neon lamp | 1/10    |
| 6543-83-101                                 | 4011395074466 | Touch dimmer center plate, Impressivo, aluminum, with neon lamp   | 1/10    |
| <b>Design series. Delivery time to ask.</b> |               |   |         |
| 6543-866-101                                | 4011395087473 | Touch dimmer center plate, painted steel                          | 1/10    |
| 6543-884-101                                | 4011395129449 | Touch dimmer center plate, white matt                             | 1/10    |
| 6543-885-101                                | 4011395129517 | Touch dimmer center plate, black matt                             | 1/10    |

**LED dimmer MRDC**

LED RL/RC rotary and RLC push type dimmers installed MRDC

| Type     | EAN           | Description            | Package |
|----------|---------------|------------------------|---------|
| 6523-500 | 4011395198636 | LED dimmer rotary MRDC | 1/10    |

**Controller 1-10 V**

Memory touch-type controller, DIN rail-mounting. For electronic control gears. For fluorescent lamps with control output. For LED control via control gears. Operation only possible via conventional push button. Nominal voltage: 230V/50Hz. Control current max. 50 mA. Switching capability 4 A cos  $\phi$  0,9 or  $\phi$  0,5. It is possible to directly connect up to 4 control gears to 1 dimmer. With larger loads, an external relay or contactor must be used.

| Type | EAN           | Description       | Package |
|------|---------------|-------------------|---------|
| 6550 | 4011395599204 | Controller 1-10 V | 1/10    |

**Dimmer spareparts**

| Type      | EAN           | Description   | Package |
|-----------|---------------|---|---------|
| 3855      | 4011395376607 | Neon lamp for dimmer                                | 10/200  |
| 2117C-214 | 6438199003887 | Center plate, rotary button and nut                 | 1/20    |
| 2115C-214 | 6418677330650 | Rotary button for Jussi dimmers, NOT for 2210UJ-214 | 20/200  |
| 2210C-214 | 6418677330667 | Rotary button for Jussi dimmer 2210UJ-214           | 20/200  |

## Motion detectors



### Motion detector 180 Comfort

230 V, 10 A relay, IP20, for flush mounting. Detection area 180 degrees, approximately 8 m to the sides and approximately 12 m to the front at the mounting height. Adjustable lighting level 5-250 lux, switch-off delay 2 sec.-30 min. Three-way operating switch (off - automatic - always on), which can be locked to the automatic position. Mounting height 1-1.2 m.

| Type                              | EAN           | Description  | Package |
|-----------------------------------|---------------|--|---------|
| <b>Impressivo (sold in parts)</b> |               |  |         |
| 6401U-102                         | 4011395991299 | Universal relay unit insert, 10 A.                           | 1/10    |
| 6800-214-104                      | 4011395990643 | Watchdog 180 Comfort sensor                                  | 1/10    |
| 6800-84-104                       | 4011395996331 | Motion detector sensor, white, Impressivo. 180 Comfort.      | 1/10    |
| 6800-81-104                       | 4011395056257 | Motion detector sensor, anthracite, Impressivo. 180 Comfort. | 1/10    |
| 6800-83-104                       | 4011395070192 | Motion detector sensor, aluminum, Impressivo. 180 Comfort.   | 1/10    |



### Motion detector 180 Comfort multiple surveillance

230 V, 10 A relay, IP20, for flush mounting. Detection area 180°. The area has been extended approximately 35° downwards. This enables e.g. the surveillance of a stairway from an upper platform. The detection range depends on the mounting height; for more information, see the specifications. Adjustable lighting level 5 - 250 lux, switch-off delay 10sec-30min. Three-way operating switch (off - automatic - always on), which can be locked to the automatic position.

| Type  | EAN           | Description   | Package |
|---|---------------|---|---------|
| <b>Jussi (incl. insert, center plate and cover frame)</b> |               |   |         |
| 6401/6800-214M  | 4011395158173 | 180 Comfort multiple surveillance, Jussi  | 1/10    |
| <b>Impressivo (sold in parts)</b>                         |               |   |         |
| 6401U-102   | 4011395991299 | Universal relay unit insert, 10 A.  | 1/10    |
| 6800-84-104M  | 4011395996355 | Motion detector sensor, white, Impressivo. 180 Comfort multiple surveillance      | 1/10    |
| 6800-81-104M  | 4011395056264 | Motion detector sensor, anthracite, Impressivo. 180 Comfort multiple surveillance | 1/10    |
| 6800-83-104M  | 4011395075203 | Motion detector sensor, aluminum, Impressivo. 180 Comfort multiple surveillance   | 1/10    |



### Motion detector Aqua 180

230 V, 10 A relay, IP44, for flush mounting. Detection area 180 degrees. The area has been extended approximately 35 degrees downwards. This enables e.g. the surveillance of a stairway from an upper platform. The detection range depends on the installation height; for more information, see the specifications. Adjustable lighting level 5 - 250 lux, switch-off delay 2 sec. - 30 min. The sensor component is mounted with the supplied Torx screws. Operation temperature -25 to +55 °C.

| Type         | EAN           | Description                            | Package |
|--------------|---------------|--|---------|
| 6401U/6800UW | 6410035150719 | Motion detector, Aqua 180, IP44, Jussi | 1/10    |

## Thermostats



### Floor heating thermostat

Floor heating thermostat for room-specific temperature adjustment. 230 V~, 50 Hz, 15 A / 3450 W, IP 31. Sensor: 3 m NTC 15 kΩ / 25 °C. Operating temperature: -10... +30 °C. Switch: 2-pole. Screw terminals: max. 2 x 2.5 mm<sup>2</sup>. Temperature drop: fixed 5 °C. Adjustment range: +5... + 45 °C. Hysteresis +/- 0,4 °C. Ball pressure temperature: 75 °C. Utilization category: 2 (home use). Type: 1C. Method of mounting: fixed. To ensure energy efficiency, the temperature drop control must be connected to a centralized timer system (EU regulation regarding Eco-design).

| Type  | EAN           | Description  | Package |
|---|---------------|--|---------|
| <b>Jussi (incl. insert, center plate and cover frame)</b> |               |  |         |
| TF16-15-214   | 6438199004532 | Floor heating thermostat, 16 A, with sensor, Jussi             | 1/10    |
| <b>Impressivo (koos sisu ja kattega)</b>                  |               |  |         |
| TF16-15-84  | 6438199004679 | Floor heating thermostat, 16 A, with sensor, IMPRESSIVO, white | 1/10    |
| <b>Impressivo (sold in parts)</b>                         |               |  |         |
| TF16-15U  | 6438199004556 | Floor heating thermostat, 16 A, with sensor, Insert            | 1/10    |
| T-11-84   | 6438199001029 | Center plate, for thermostat, Impressivo, white                | 1/10    |
| T-11-81   | 6438199001005 | Center plate, for thermostat, Impressivo, anthracite           | 1/10    |
| T-11-83   | 6438199001012 | Center plate, for thermostat, Impressivo, aluminum             | 1/10    |
| T-11-866  | 6438199001043 | Center plate, for thermostat, Impressivo, painted steel        | 1/10    |

## Motor controllers



### Motor controller 1A and 2,5A, IP21

For controlling the operating speed of fan motors. Nominal voltage: 230 V, 50 Hz.

| Type  | EAN           | Description   | Package |
|---|---------------|---|---------|
| <b>Jussi (incl. insert, center plate and cover frame)</b> |               |   |         |
| 2299UCJ-214   | 6410035127551 | Motor controller 0.1-1 A, Jussi                     | 1/10    |
| 2297UCJ-214   | 6410035127568 | Motor controller 0.1-2.5 A, Jussi                   | 1/10    |
| <b>Design series. Delivery time to ask.</b>               |               |   |         |
| 6540-866-102  | 4011395125496 | Dimmer center plate, neon lamp included, steel      | 1/10    |
| 6540-884-102  | 4011395129425 | Dimmer center plate, neon lamp included, white matt | 1/10    |
| 6540-885-102  | 4011395129487 | Dimmer center plate, neon lamp included, black matt | 1/10    |



### Motor controller 4.3 A

For controlling the operating speed of fan motors. Nominal voltage: 230 V, 50 Hz. Delivered with incandescent lamp and a reserve fuse. Installation in a double mounting box e.g. AU17.2.

| Type        | EAN           | Description                       | Package |
|-------------|---------------|-----------------------------------|---------|
| 2296UCJ-214 | 6410035127575 | Motor controller 0.2-4.3 A, Jussi | 1/20    |

## Audio



### DigitalRadio set

2-gang combination digital radio and loudspeaker (flush mounted). The radio offers a stereo RDS tuner with 8 memory presets as well as programmable clock, alarm and snooze functions which are controlled with the switch rocker.

| Type    | EAN           | Description                         | Package |
|---------|---------------|-------------------------------------|---------|
| 8220-84 | 4011395113110 | DigitalRadio set, Impressivo, white | 1/10    |



### DigitalRadio

The radio offers a stereo RDS tuner with 8 memory presets as well as programmable clock, alarm and snooze functions. Output max. 2x2W. Frequency response: 100 - 10 000 Hz. Reception frequency 87,50 - 108,0 Mhz. IP20.

| Type  | EAN           | Description  | Package |
|---|---------------|--|---------|
| <b>Insert</b>                               |               |  |         |
| 8215U                                       | 4011395104439 | Digital Radio Insert, FM                           | 1/10    |
| <b>Jussi center plate</b>                   |               |  |         |
| 8252-214                                    | 4011395104521 | DigitalRadio, center plate, Jussi                  | 1/10    |
| <b>Impressivo center plates</b>             |               |  |         |
| 8252-84                                     | 4011395104569 | DigitalRadio, center plate, Impressivo, white      | 1/10    |
| 8252-81                                     | 4011395104538 | DigitalRadio, center plate, Impressivo, anthracite | 1/10    |
| 8252-83                                     | 4011395104552 | DigitalRadio, center plate, Impressivo, aluminum   | 1/10    |
| <b>Design series. Delivery time to ask.</b> |               |  |         |
| 8252-866                                    | 4011395104637 | DigitalRadio, center plate, painted steel          | 1/10    |
| 8252-884                                    | 4011395130063 | DigitalRadio, center plate, white matt             | 1/10    |
| 8252-885                                    | 4011395130117 | DigitalRadio, center plate, black matt             | 1/10    |



### Loudspeaker

For DigitalRadio 8215U. Size 2". Rated output 2W. Frequency response: 200 - 20 000 Hz, IP20.

| Type  | EAN           | Description                                       | Package |
|---|---------------|---|---------|
| <b>Insert</b>                               |               |   |         |
| 8223U                                       | 4011395104446 | Loudspeaker insert                                | 1/10    |
| <b>Jussi</b>                                |               |   |         |
| 8253-214                                    | 4011395104811 | Loudspeaker, center plate, Jussi                  | 1/10    |
| <b>IMPRESSIVO</b>                           |               |   |         |
| 8253-84                                     | 4011395104859 | Loudspeaker, center plate, Impressivo, white      | 1/10    |
| 8253-81                                     | 4011395104828 | Loudspeaker, center plate, Impressivo, anthracite | 1/10    |
| 8253-83                                     | 4011395104842 | Loudspeaker, center plate, Impressivo, aluminum   | 1/10    |
| <b>Design series. Delivery time to ask.</b> |               |   |         |
| 8253-866                                    | 4011395104927 | Loudspeaker center plate, painted steel           | 1/10    |
| 8253-884                                    | 4011395130087 | Loudspeaker center plate, white matt              | 1/10    |
| 8253-885                                    | 4011395130131 | Loudspeaker center plate, black matt              | 1/10    |



### iNetRadio

WLAN Internet radio with display for flush-mounted installation. For the reception of national and international radio stations via Internet. Radio station search possible via various genres. Integrated web-server for configuration and control. Remote operation with smartphone via browser surface. UPnP replay function. It is controlled via smartphone. For mono/stereo operation. 8 radio stations storable.

| Type   | EAN           | Description  | Package |
|--|---------------|--|---------|
| <b>IMPRESSIVO set Design series. Delivery time to ask.</b> |               |  |         |
| 8240-84-500  | 4011395157251 | iNetRadio kit                                      | 1/10    |
| <b>Design series. Delivery time to ask.</b>                |               |  |         |
| 8216U-500  | 4011395157220 | iNetRadio  | 1/10    |
| 8252-214   | 4011395104521 | DigitalRadio, center plate, Jussi                  | 1/10    |
| 8252-84  | 4011395104569 | DigitalRadio, center plate, Impressivo, white      | 1/10    |
| 8252-81  | 4011395104538 | DigitalRadio, center plate, Impressivo, anthracite | 1/10    |
| 8252-83  | 4011395104552 | DigitalRadio, center plate, Impressivo, aluminum   | 1/10    |

## Timers

### Countdown timer

User friendly timer with fixed time settings 15 min, 30 min, 1h, 2h, 4h or 8h. Countdown time is set with a screwdriver. 2-pole switch.



| Type  | EAN           | Description                         | Package |
|---|---------------|-------------------------------------|---------|
| <b>Jussi (incl. insert and center plate)</b>      |               |                                     |         |
| T210-214  | 6438199002231 | Basic timer, Jussi                  | 1/10    |
| <b>Impressivo (incl. insert and center plate)</b> |               |                                     |         |
| T210-84   | 6438199002248 | Basic timer, Impressivo, white      | 1/10    |
| T210-81   | 6438199002255 | Basic timer, Impressivo, anthracite | 1/10    |
| T210-83   | 6438199002262 | Basic timer, Impressivo, aluminum   | 1/10    |

### Timer kits

Timer kits include Jussi-timer, single schuko socket outlet and installation frame or box.

Fixed time options: 15 min, 30 min, 1h, 2h, 4h and 8h. Exchangeable labels with the time options to mark center plate with selected time. 230 VAC, 50Hz, 0 - 40C, IP21, 2-pole wiring. 10A resistiv load (2300 W), 2AX-load (e.g. fluorescent lamp). Screw terminals max 2,5 mm<sup>2</sup>. Signal light when active.



| Type               | EAN           | Description                | Package |
|--------------------|---------------|----------------------------|---------|
| T210-20EUCKS-214   | 6438199003429 | Timer set frame, Jussi     | 1/10    |
| T210-20EUCKS-214.H | 6438199003412 | Timer set corner box Jussi | 1/10    |

### Timer switches

Timer switch display, 10 A. Four switching times per day can be user-defined for each day of the week. Automatic summer/wintertime switch-over. 14-hour power reserve. Nominal voltage: 230 V/50 Hz. Operating temperature range: 0 °C - 35 °C. Timer switch insert is connected to universal relay unit 6401U-102. Suitable center plates 6435-8X.



| Type  | EAN           | Description                                      | Package |
|---|---------------|--|---------|
| <b>Inserts</b>                              |               |  |         |
| 6401U-102                                   | 4011395991299 | Universal relay unit insert, 10 A.               | 1/10    |
| 6455-101-500                                | 4011395186657 | Timer switch display                             | 1/10    |
| <b>Centre plates</b>                        |               |  |         |
| 6435-214                                    | 4011395071656 | Center plate for timer switch, Jussi             | 1/10    |
| 6435-84                                     | 4011395071854 | Timer switch, center plate, Impressivo, white    | 1/10    |
| 6435-83                                     | 4011395071922 | Timer switch, center plate, Impressivo, aluminum | 1/10    |
| <b>Design series. Delivery time to ask.</b> |               |  |         |
| 6435-866                                    | 4011395086919 | Timer switch, center plate, painted steel        | 1/10    |
| 6435-884                                    | 4011395148013 | Timer switch, center plate, white matt           | 1       |
| 6435-885                                    | 4011395148020 | Timer switch, center plate, black matt           | 1       |

## RF-products

Radiofrequency operated switches and relays



### RF EnOcean products

| Type                        | EAN           | Description   | Package |
|-----------------------------|---------------|---|---------|
| <b>Delivery time to ask</b> |               |   |         |
| 1786RF-84                   | 6418677334719 | Push button EnOcean, 1-gang, Impressivo, white      | 1       |
| 1786RF-81                   | 6418677334733 | Push button EnOcean, 1-gang, Impressivo, anthracite | 1       |
| 1786RF-83                   | 6418677334726 | Push button EnOcean, 1-gang, Impressivo, aluminum   | 1       |
| 1785RF-84                   | 6418677334740 | Push button EnOcean, 2-gang, Impressivo, white      | 1       |
| <b>Delivery time to ask</b> |               |   |         |
| 1785RF-81                   | 6418677334764 | Push button EnOcean, 2-gang, Impressivo, anthracite | 1       |
| 1785RF-83                   | 6418677334757 | Push button EnOcean, 2-gang, Impressivo, aluminum   | 1       |
| 6401/RF                     | 6418677334771 | Switch actuator EnOcean, 1-fold 10 A, FM            | 1       |
| <b>Delivery time to ask</b> |               |   |         |
| EG/A32.2.1                  | 4016779942577 | KNX/EnOcean Gateway, SM                             | 1       |

## RF-products with battery

Radio frequency operated battery powered switches, watchdogs, dimmers, relays and displays.



### 1-gang, RF-wireless push buttons, Jussi and Impressivo

| Type                                  | EAN           | Description   | Package |
|---------------------------------------|---------------|---|---------|
| 6731-214-500                          | 8427238091549 | Wireless Push Button 1-gang Jussi RF                    | 1/10    |
| 6731-84-500                           | 8427238091587 | 1-gang Impressivo RF, white                             | 1/10    |
| <b>By order: delivery time to ask</b> |               |   |         |
| 6731-83-500                           | 8427238091594 | Wireless Push Button 1-gang Impressivo RF, aluminum     | 1/10    |
| 6731-866-500                          | 8427238091600 | Wireless Push button 1-gang Impressivo RF painted steel | 1/10    |



### 2-gang, RF-wireless push buttons, Impressivo

| Type                                  | EAN           | Description   | Package |
|---------------------------------------|---------------|---|---------|
| 6732-214-500                          | 8427238091563 | Wireless Push Button 2-gang Jussi RF                    | 1/10    |
| 6732-84-500                           | 8427238091631 | Wireless Push Button 2-gang Impressivo RF, white        | 1/10    |
| <b>By order: delivery time to ask</b> |               |   |         |
| 6732-83-500                           | 8427238091624 | Wireless Push Button 2-gang Impressivo RF, aluminum     | 1/10    |
| 6732-866-500                          | 8427238091648 | Wireless Push button 2-gang Impressivo RF painted steel | 1/10    |



### 4-gang, RF-wireless push buttons, Impressivo

| Type                                  | EAN           | Description   | Package |
|---------------------------------------|---------------|---|---------|
| 6733-84-500                           | 8427238091716 | Wireless Push Button 4-gang Impressivo RF, white        | 1/10    |
| <b>By order: delivery time to ask</b> |               |   |         |
| 6733-83-500                           | 8427238091709 | Wireless Push Button 4-gang Impressivo RF, aluminum     | 1/10    |
| 6733-866-500                          | 8427238091723 | Wireless Push Button 4-gang Impressivo RF painted steel | 1/10    |

**RF-receivers, flushmounted**

| Type         | EAN           | Description                                    | Package |
|--------------|---------------|--|---------|
| 6701-101-500 | 4011395182642 | Watchdog receiver, RF, 230 V, 10AX             | 1/10    |
| 6702-500     | 8427238091747 | Receiver, RF, reley, 230 V, 10AX               | 1/10    |
| 6703-500     | 8427238091754 | Switch actuator RF, 230 V, 2x3AX               | 1/10    |
| 6705-500     | 8427238091761 | Blind actuator, RF, 230 V, 2x3A                | 1/10    |
| 6704-500     | 4011395134375 | Universal dimming actuator, RF, 230 V, 35-210W | 1/10    |



04

## Technical information

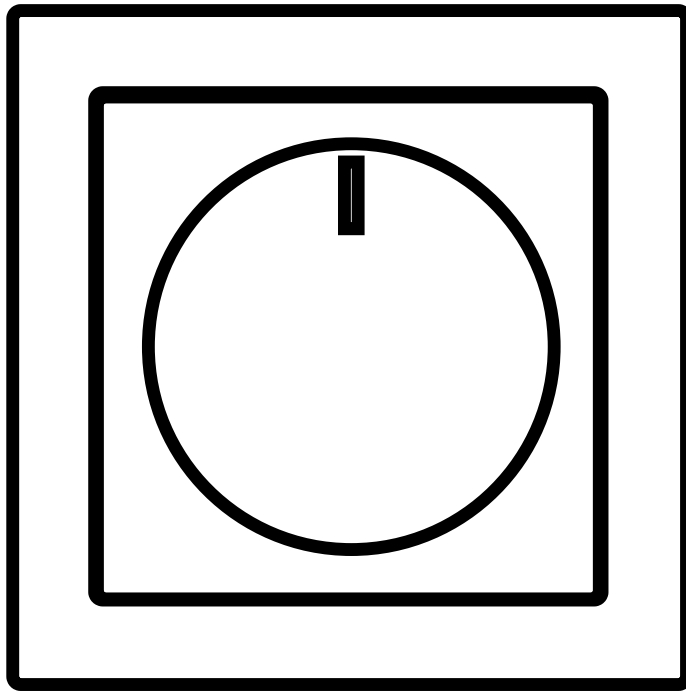



## Technical information

### **Impressivo**

|                     |    |
|---------------------|----|
| Flush mounting      | 74 |
| DKS-system          | 81 |
| Surface mounting    | 75 |
| Cover frames frames | 76 |

### **Jussi**

|                            |    |
|----------------------------|----|
| Flush mounting             | 79 |
| DKS-system                 | 81 |
| Cover frames frames        | 82 |
| Surface mounting           | 83 |
| Surface mounting IP44/IP55 | 84 |

### **Electronics**

|                    |    |
|--------------------|----|
| Dimmers and timers | 84 |
|--------------------|----|

# Impressivo

## Flush mounting

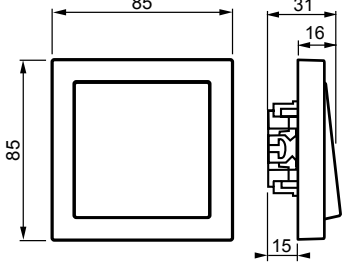
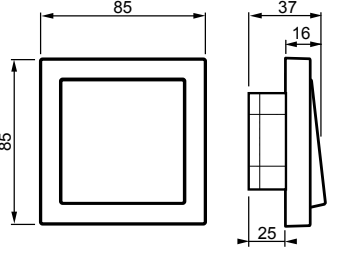
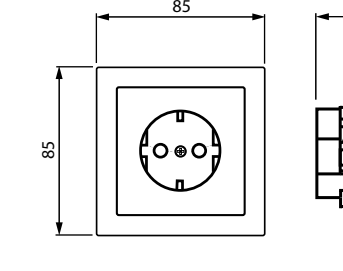
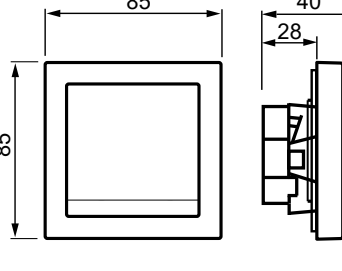
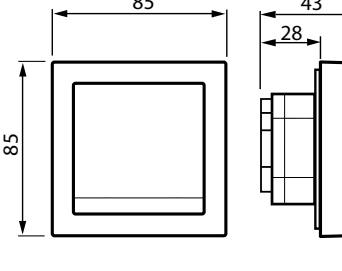
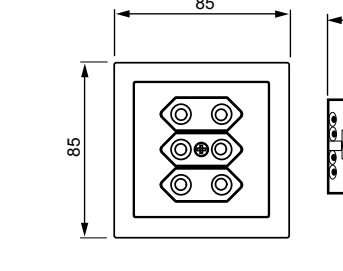
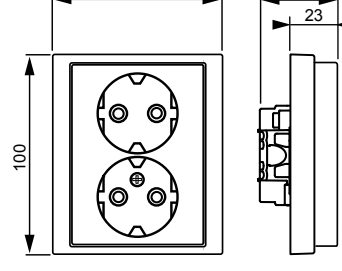
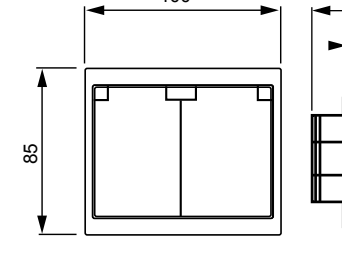
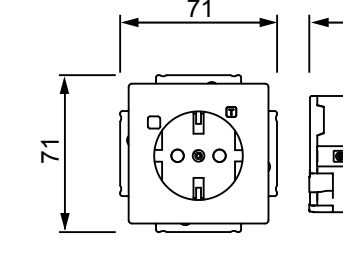
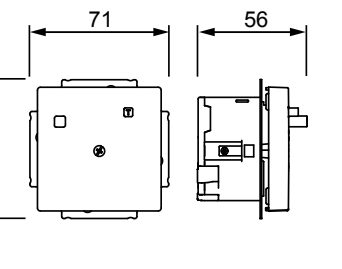
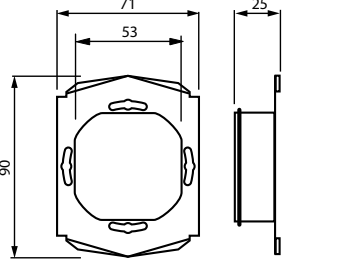
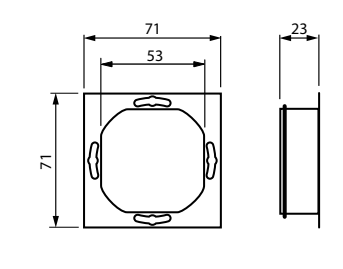
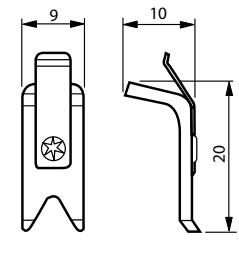
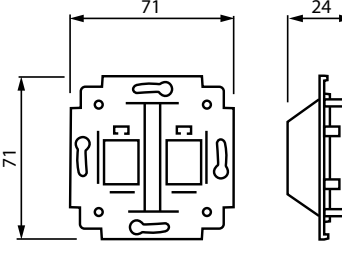
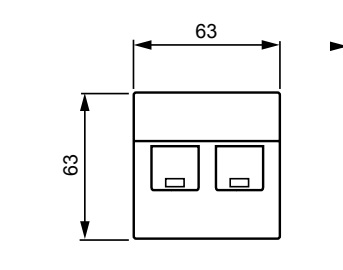
|   |   |  |
|---|---|--|
|  <p>Switch, IP21</p>                         |  <p>Switch, IP44</p>                         |  <p>1-gang socket outlet, IP21</p> |
|  <p>1-gang socket outlet with lid, IP21</p> |  <p>1-gang socket outlet with lid, IP44</p> |  <p>3-gang euro socket</p>        |
|  <p>2-gang socket outlets, IP21</p>        |  <p>302EUJW-8X</p>                         |  <p>3120EUC-84</p>               |
|  <p>3150UC-84.1</p>                        |  <p>2464</p>                               |  <p>2463</p>                     |
|  <p>ASE1</p>                               |  <p>1819.0x</p>                            |  <p>1819DC-8x</p>                |

# Impressivo

## Surface mounting

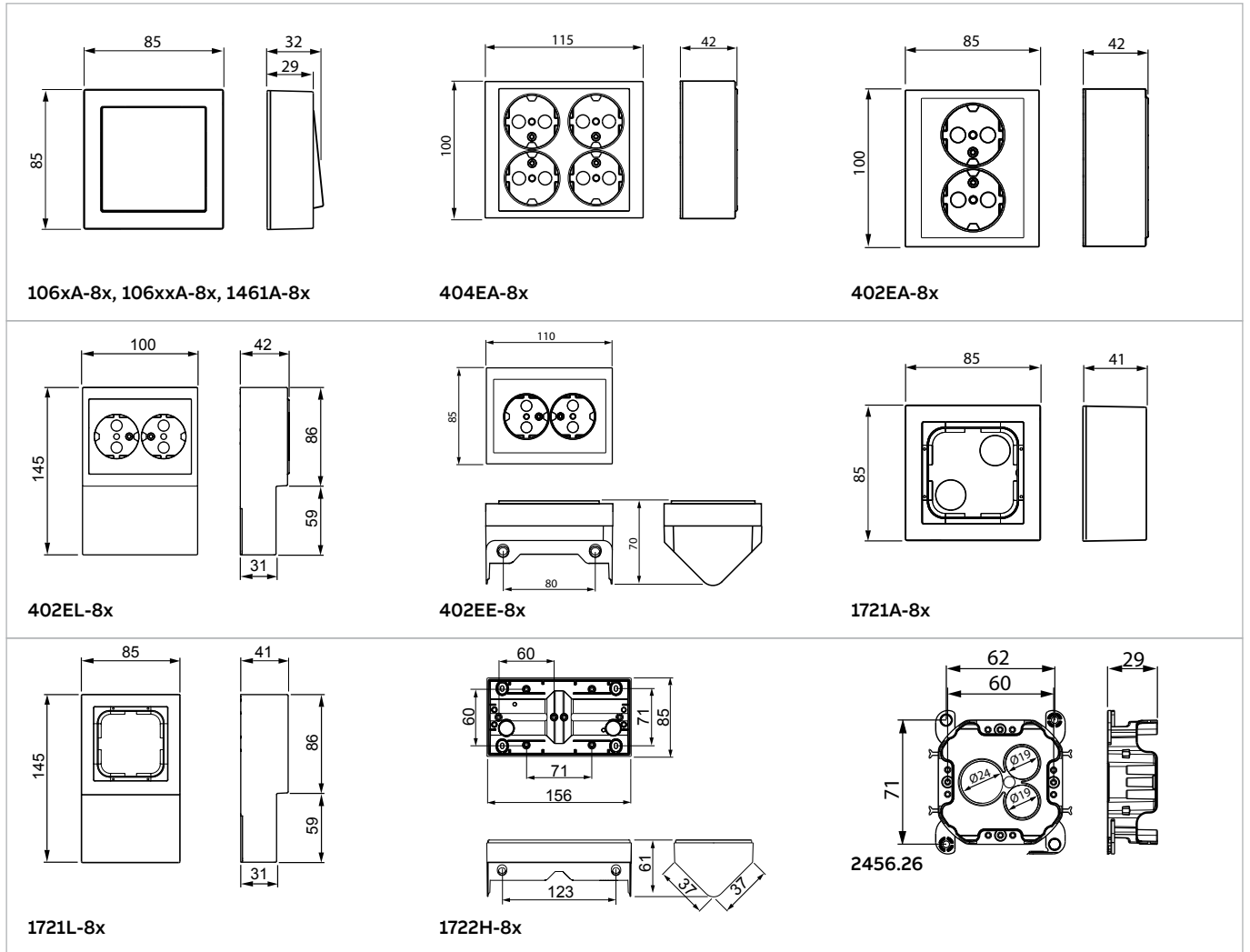

## Impressivo-cover frames frames

Cover frames, 85 mm, IP21

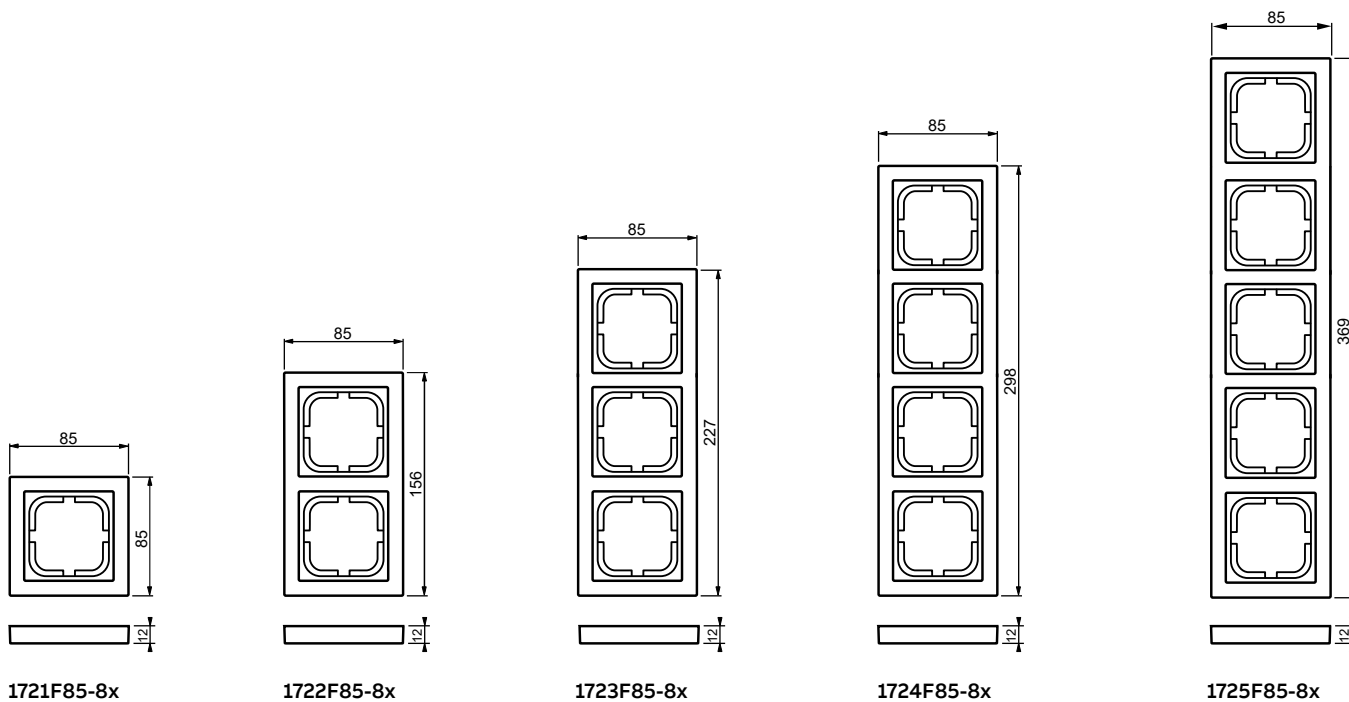

Cover frames, 100 mm, IP21

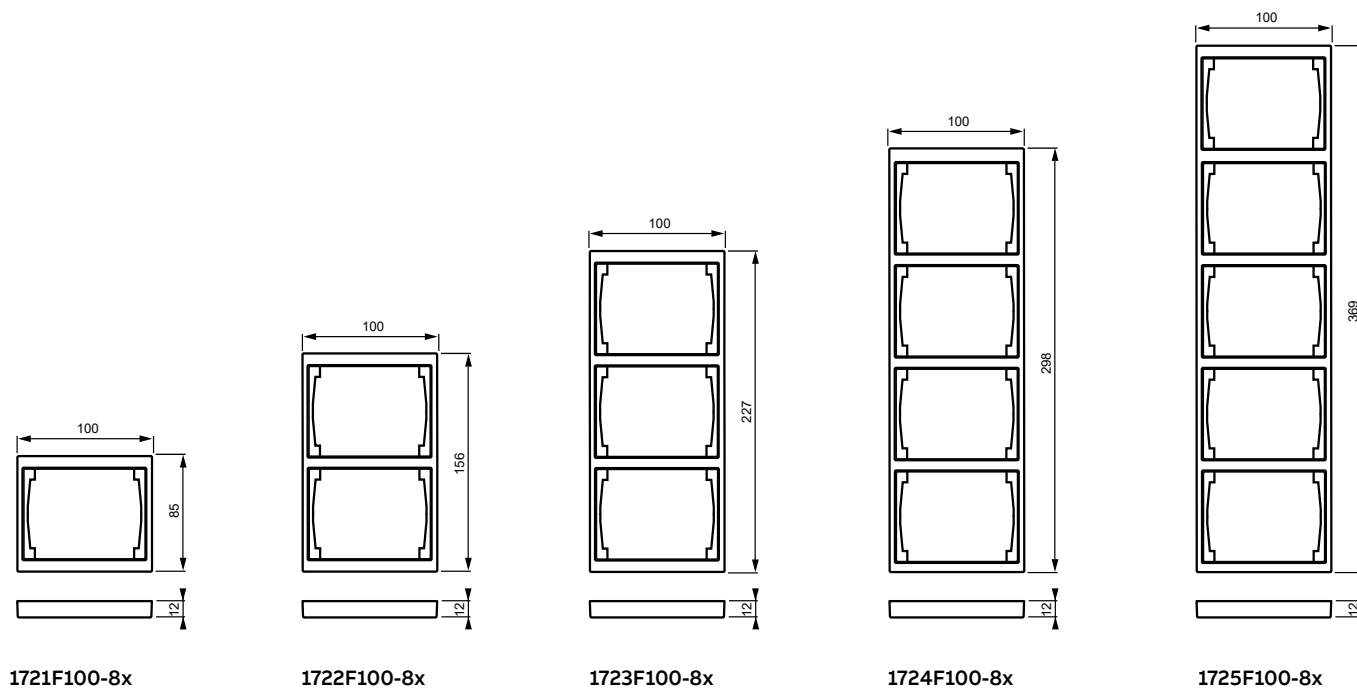

Surface mounting cover frames 100 mm, IP21/IP44

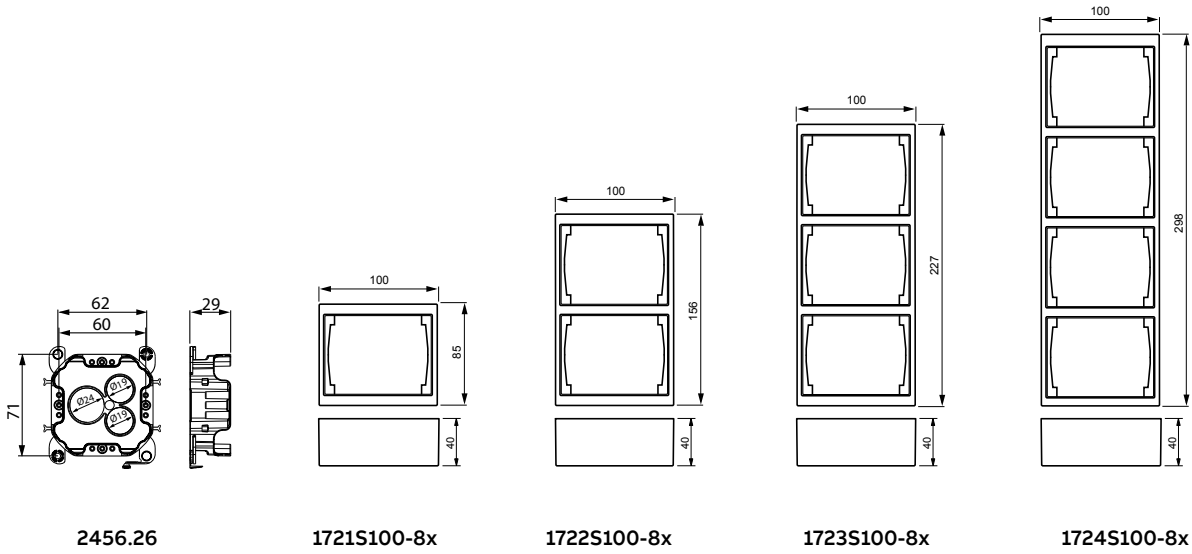

Surface mounting cover frames 85 mm, IP21/IP44

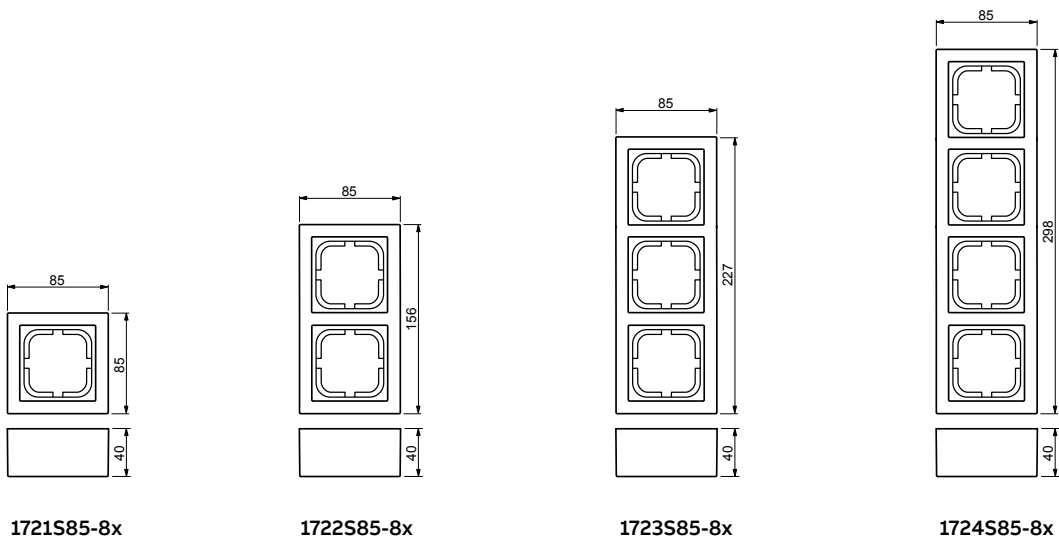

Surface mounting boxes 80 mm, IP20

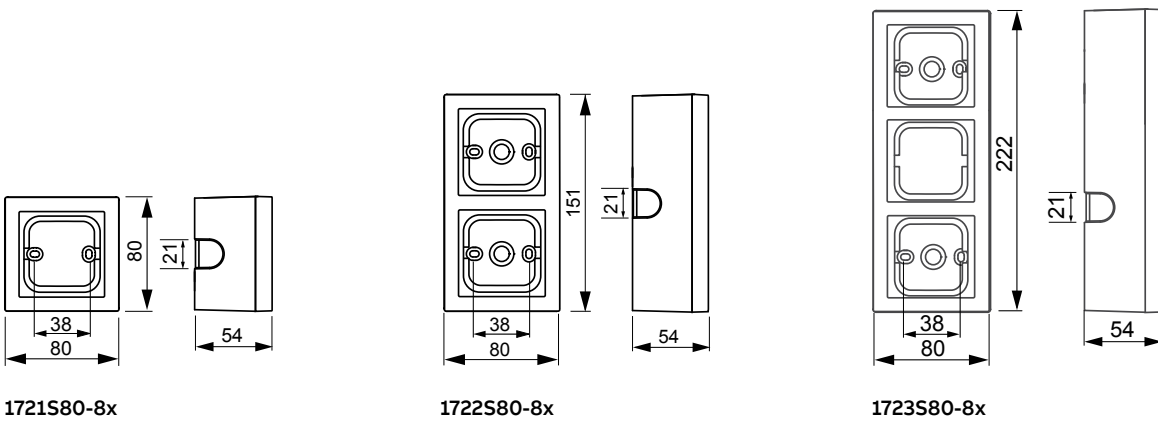

accent cover frames, 91 mm

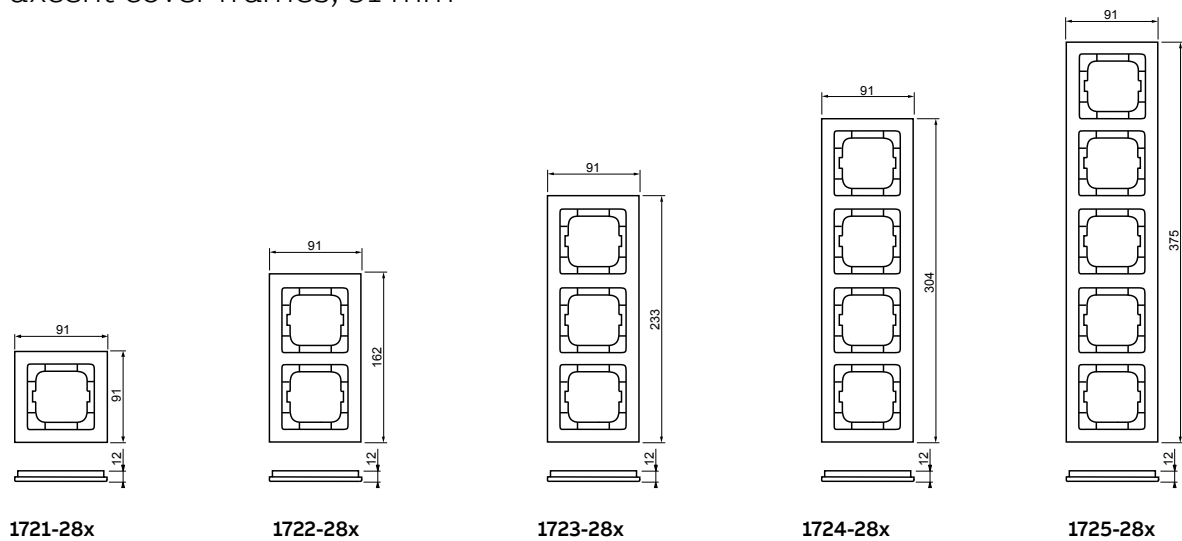

1721-28x

1722-28x

1723-28x

1724-28x

1725-28x

carat cover frames, 107 mm

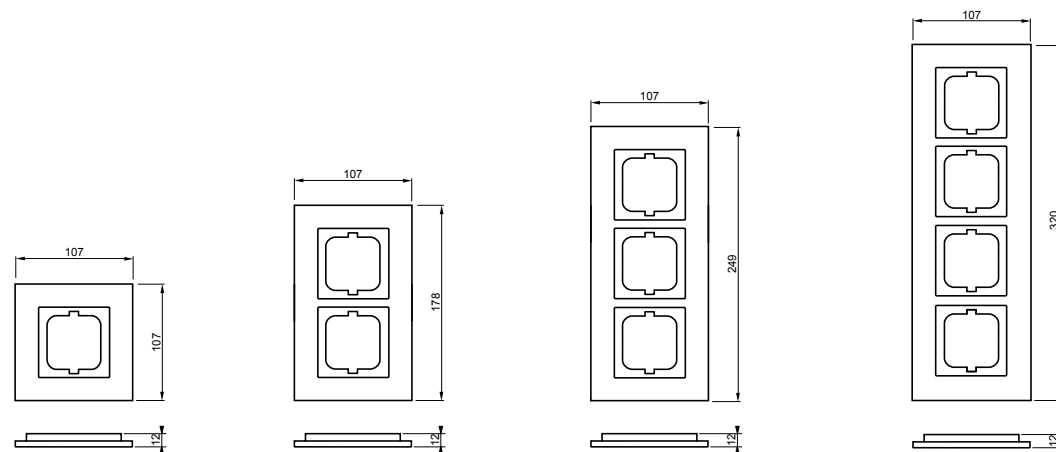

1721-8xx

1722-8xx

1723-8xx

1724-8xx

Pure stainless steel and future® linear, 80 mm

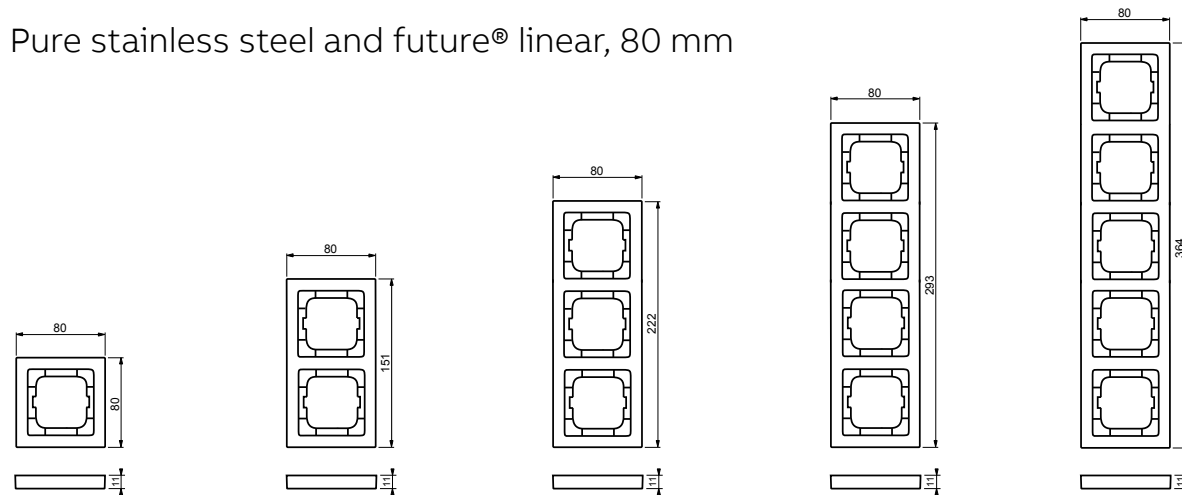

1721-8xxK

1722-8xxK

1723-8xxK

1724-8xxK

1725-8xxK

## Jussi flush mounting

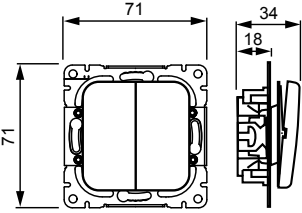
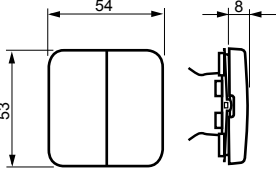
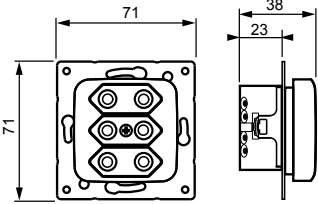
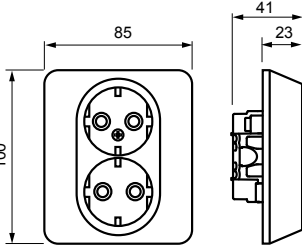
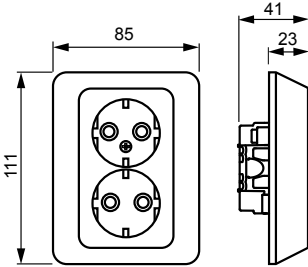
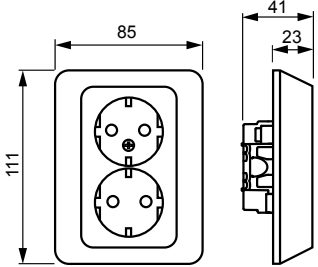
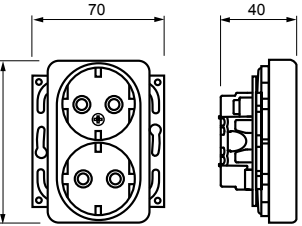
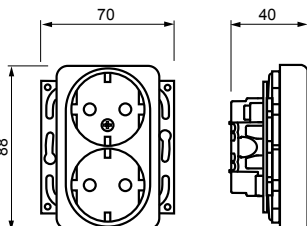
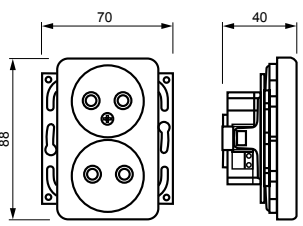
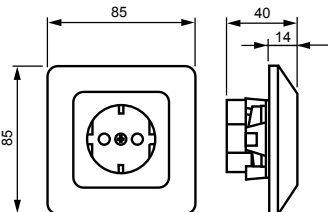
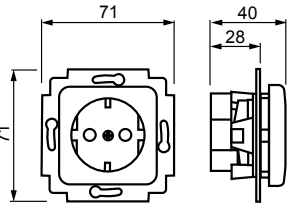
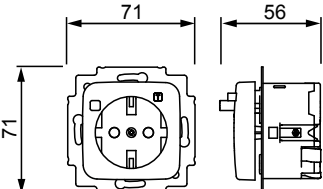
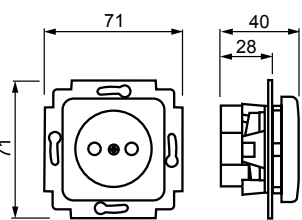
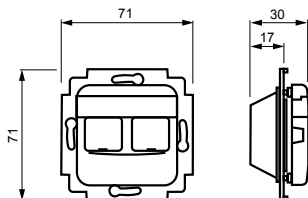
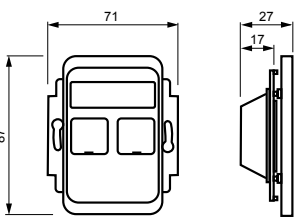
|  |  |  |
|--|--|--|
|  <p>Switches</p>      |  <p>rockers</p>                     |  <p>303UC</p>         |
|  <p>302EUJ</p>        |  <p>302EUJ.1</p>                   |  <p>232EUJ</p>       |
|  <p>302EUC</p>      |  <p>232EUC</p>                    |  <p>302UC</p>       |
|  <p>20EUJKS-212</p> |  <p>20EUCKS-212, 20EUCBLI-214</p> |  <p>3120EUC-214</p> |
|  <p>23-01UC-212</p> |  <p>FOT50xx</p>                   |  <p>FOT50xx-100</p> |

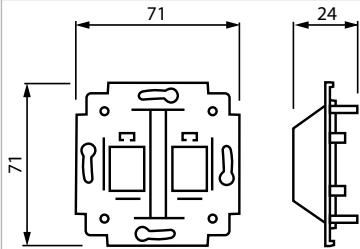

1819.0x

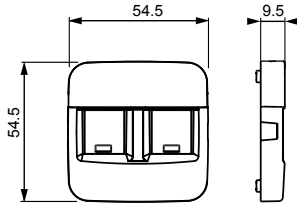

1819DC-214

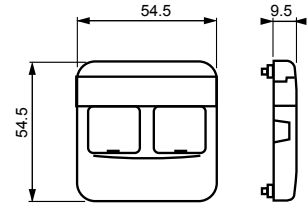

1819-214

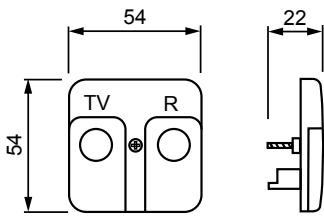

2531

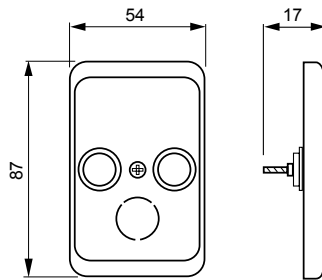

2531-100

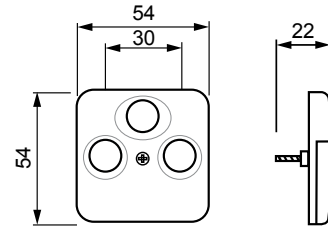

1743-03-214

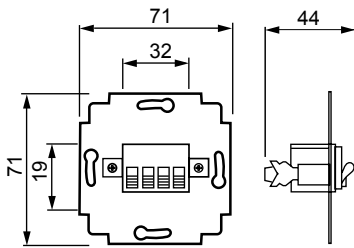

0248.00

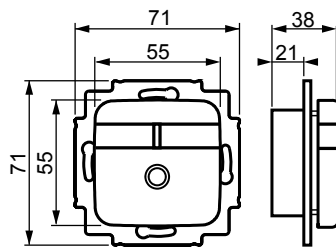

FOT3103

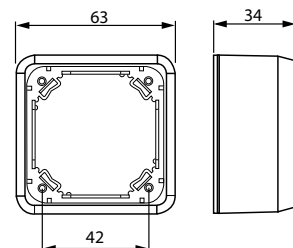

FLK1010

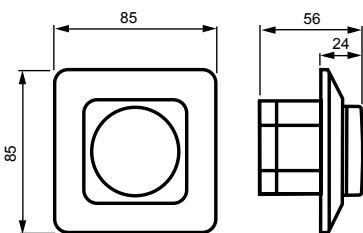

2250UJGL-214

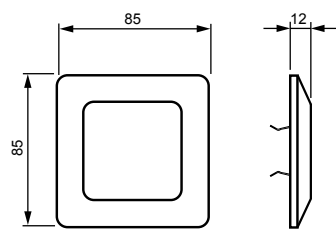

2607

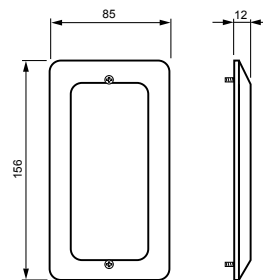

2608

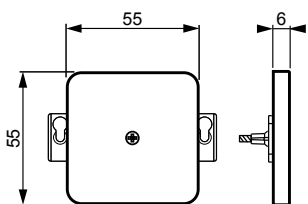

2538-212

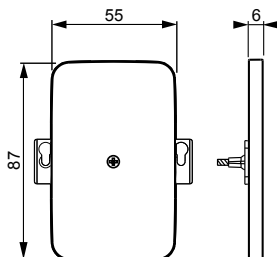

2538-100-214



DKS-system

|                                     |  |   |
|-------------------------------------|--|---|
|                                     |  |   |
| <p><b>Impressivo, 1758-xx</b></p>   | <p><b>Jussi, 1758-214</b></p>              | <p><b>1850EB, 9-pin D-connector</b></p>   |
|                                     |  |   |
| <p><b>1853EB, XLR type FP</b></p>   | <p><b>1854EB, XLR type MP</b></p>          | <p><b>1855EB, 2 x BNC/TNC</b></p>         |
|                                     |  |   |
| <p><b>1857EB, 2 x BNC/TNC</b></p>   | <p><b>1867EB, 2 x RJ45 Keystone</b></p>    | <p><b>1868EB, IBM LAN</b></p>             |
|                                     |  |   |
| <p><b>1869EB, blank</b></p>         | <p><b>1870EB, 2 x Simplex ST fiber</b></p> | <p><b>1872EB, 2 x RJ45, Systimax</b></p>  |
|                                     |  |   |
| <p><b>1874EB, 2 x SCD fiber</b></p> | <p><b>1875EB, 2 x RJ45 AMP</b></p>         | <p><b>1876EB, XLR D-type, Speakon</b></p> |

## Jussi cover frames

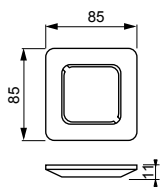

2511

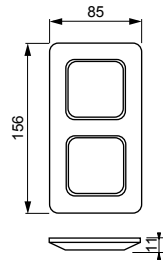

2512

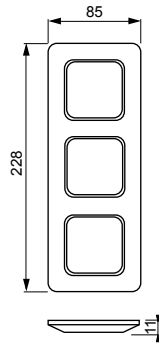

2513

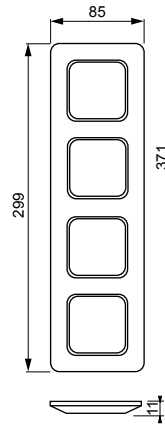

2514

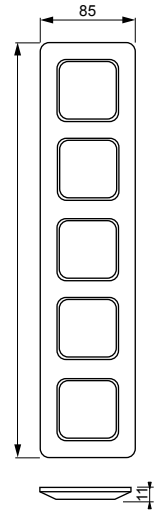

2515

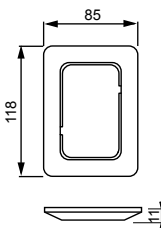

2521

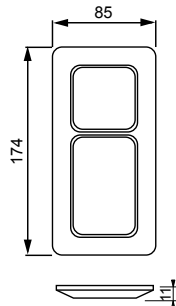

2522

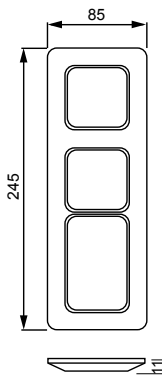

2523

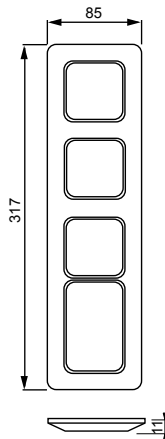

2524

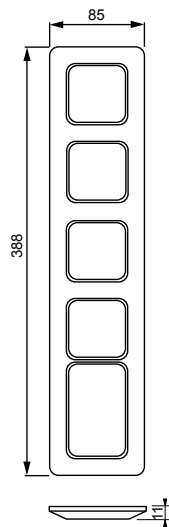

2525

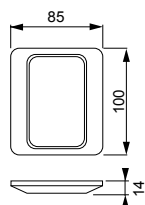

2521-100

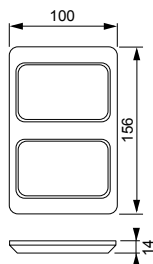

2522-100

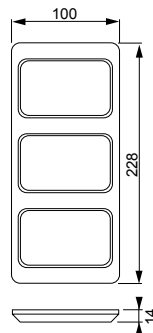

2523-100

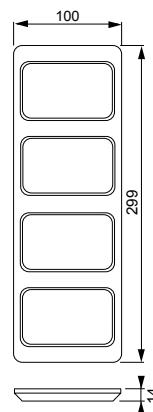

2524-100

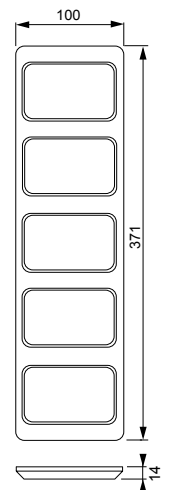

2525-100

## Jussi surface mounting

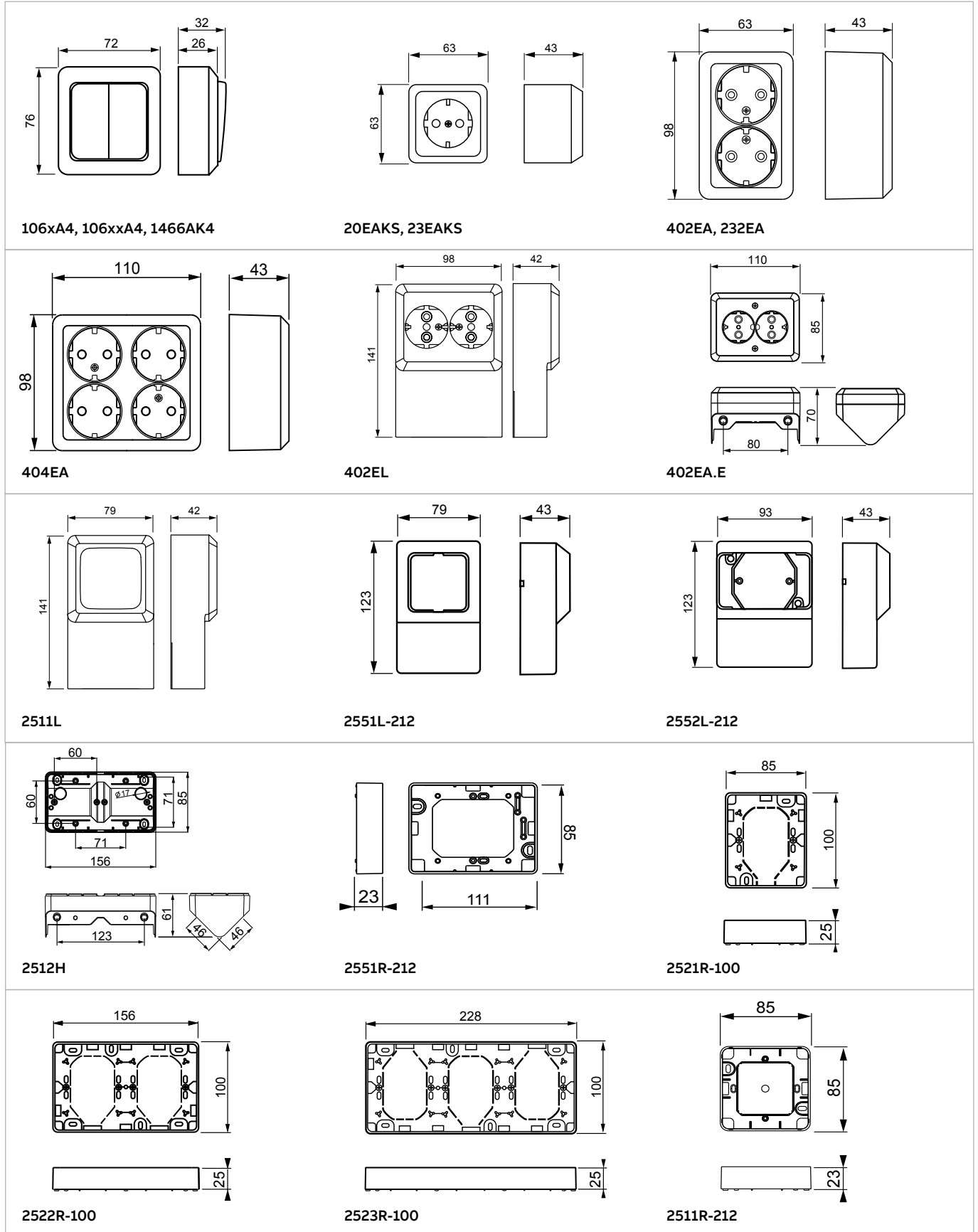

## Jussi surface mounting IP44/IP55

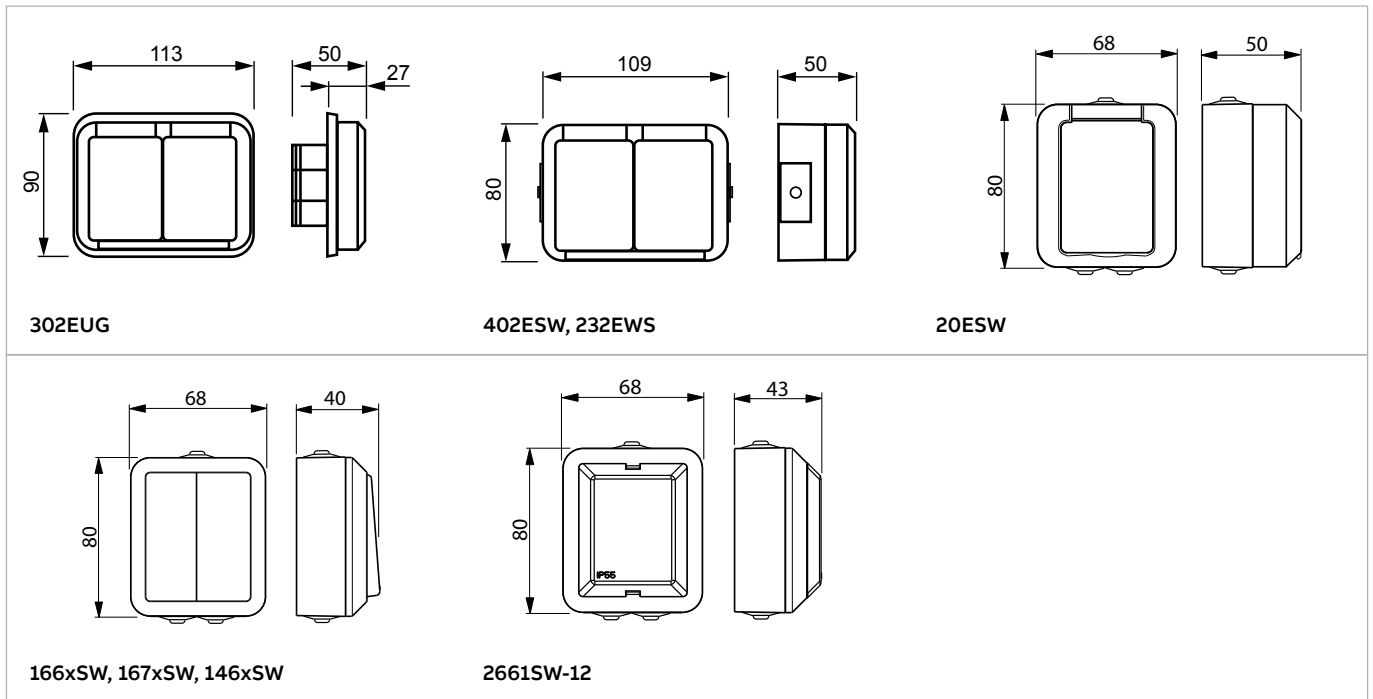

## Electronics

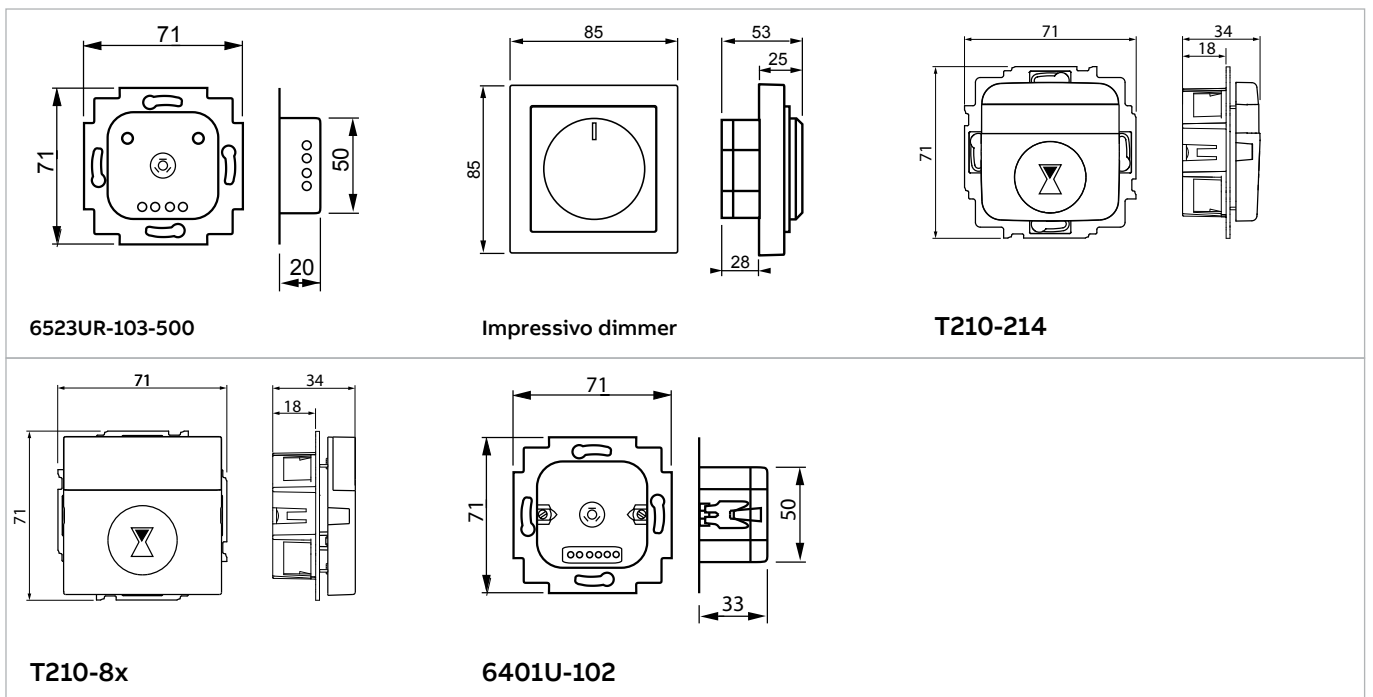





—

**ABB OY**

P.O. Box 16 (Porvoon Sisäkehä 2)

Porvoo

Finland

Tel: +358 10 22 11

**abb.com**

**installationmaterials.com**