



---

**ABB Switzerland Ltd.**  
**Low Voltage Products**

Fulachstrasse 150  
CH-8201 Schaffhausen  
Telefon +41 (0) 58 586 41 11  
Telefax +41 (0) 58 586 42 22

**[abb.com/category](http://abb.com/category)**

When working under load please follow the applicable regulations and laws according to the country.

Due to possible changes in provisions, materials and dimensions are the properties contained in this catalogue only after confirmation by ABB to be considered binding.

---

We reserve the right to make technical changes or modify the contents of this document without prior notice. With regard to purchase orders, the agreed particulars shall prevail. ABB AG does not accept any responsibility whatsoever for potential errors or possible lack of information in this document

We reserve all rights in this document and in the subject matter and illustrations contained therein. Any reproduction, disclosure to third parties or utilization of its contents – in whole or in parts – is forbidden without prior written consent of ABB AG.

© Copyright 2022 ABB. All rights reserved.  
Specifications subject to change without notice.

---

TECHNICAL CATALOGUE

# SMISLINE TP-Touch proof system

## Power and safety

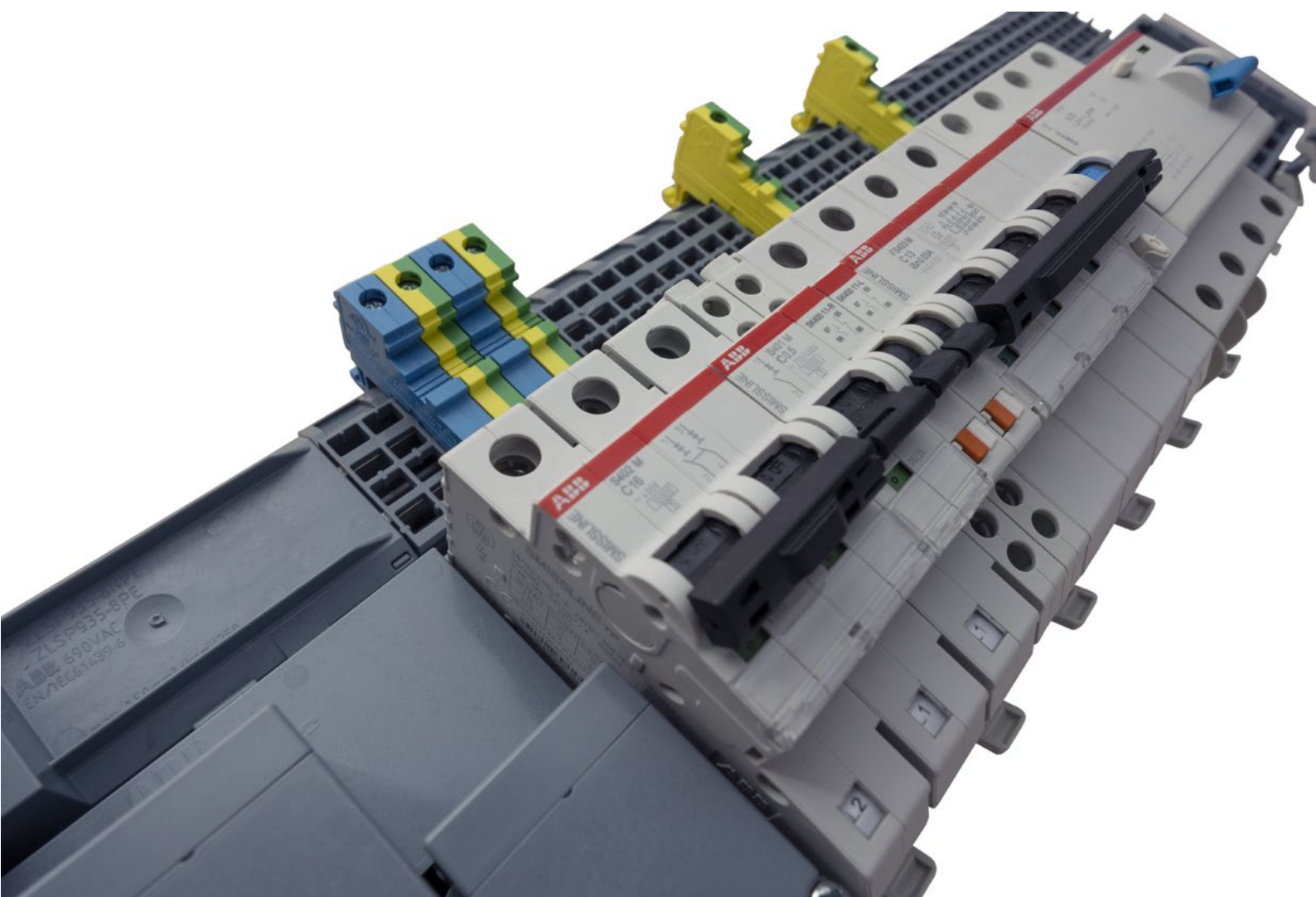

- Devices and components can be plugged on and off under voltage
- Rapid replacement, easy expansion
- Maximum system availability

—  
**Small cause, large effect.**

**The plug-in SMISLINE TP system main strengths are wherever rapid replacement, simple expansion capabilities, a mixed-polarity layout or a high level of standardization is required.**

**It is also the perfect fit for any application where costly downtime must be avoided.**



# Table of contents

<b>01. Product news</b>	4
<b>02. Miniature circuit breaker</b>	12
<b>03. Residual current devices</b>	36
<b>04. Surge arrester</b>	51
<b>05. Switch disconnecter</b>	54
<b>06. Accessory</b>	56
<b>07. Busbar system 125 A</b>	61
<b>08. Busbar system 250 A</b>	84
<b>09. Direct Feed 250 A</b>	94
<b>10. Technical data</b>	97
<b>11. Dimension of SMISLINE</b>	139
<b>12. Approvals and standards</b>	145

# SMISLINE: Online Configurator Software tool

## SMISLINE Designer Software online Version

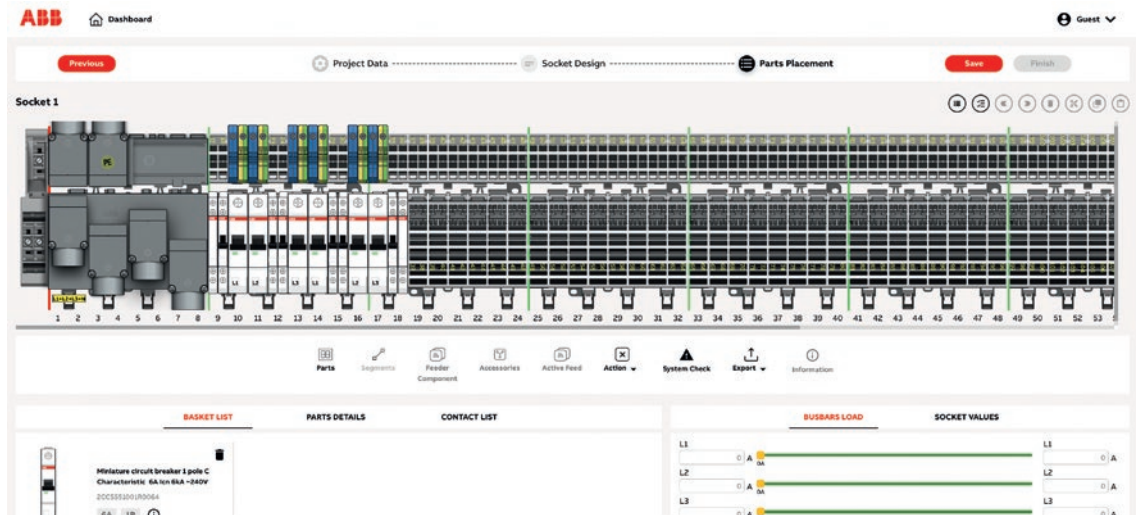

- The plug-in SMISLINE TP system main strengths are wherever rapid replacement, simple expansion capabilities, a mixed-polarity layout or a high level of standardization is required.
- The new online Design Software tool is supporting the configuration for the SMISLINE busbar system including all the range of products on the system. It is helping an easy planning and managing a project. The Software support commercial and technical information's.
- After design a project with one or numerous busbar rows for the 125A, 250A or direct feed system, the data can be export. Exports are possible for part list, Tender text or for some technical information like the current flow list.

<https://app.smisline.abb/>

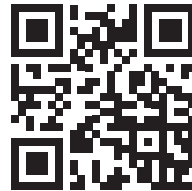

# SMISLINE ONLINE

### SMISLINE TP Homepage

<https://new.abb.com/low-voltage/products/system-pro-m/smisline-tp>



### SOC - Selected Optimized Coordination

See as well ABB on <https://www.lowvoltage-tools.abb.com/soc/>

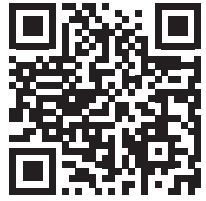

## SOC - SELECTED OPTIMIZED COORDINATION

Power and productivity  
for a better world™ **ABB**



Motor protection

Selectivity

Back-up

Other devices protection



### SOC - Selected Optimized Coordination

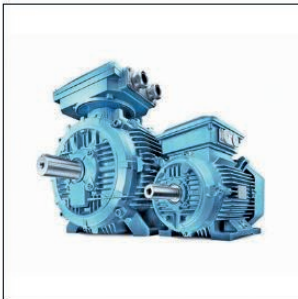

# SMISLINE TP Power Bar System 250 A

## More Power with Proven Safety

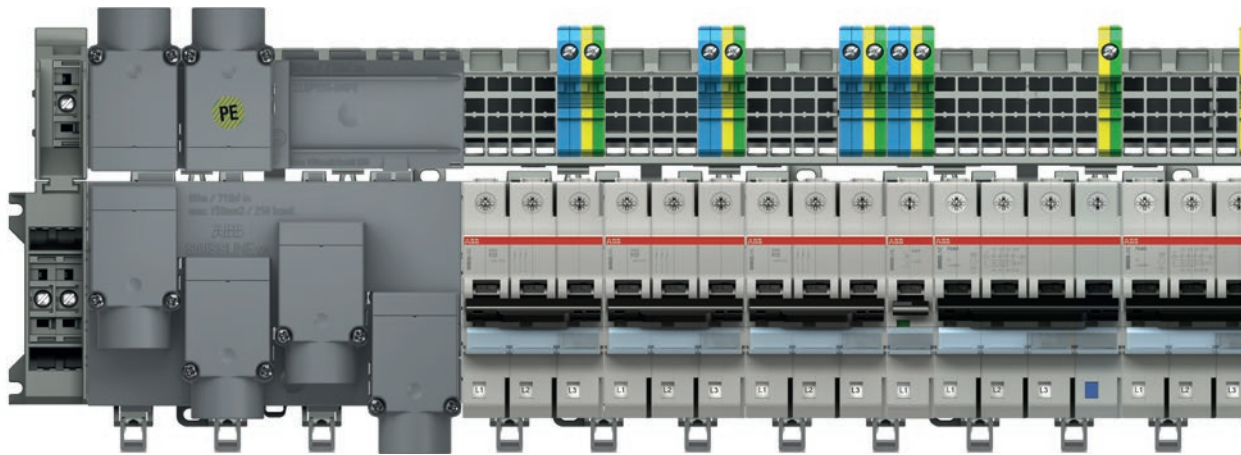

With the new SMISLINE TP Power Bar System, a high-performance 250 A system is now available. The busbars thus enable lateral 250 A power supply. This increases the range of possible applications.

Especially in applications involving high-current devices, this increases the scope to realize applications. More outputs with high current levels can be positioned on the same busbar system. The power bar system is compatible with the previous directly pluggable devices.

An incoming terminal block is now also available with the connection option for ring lugs. This facilitates connection sizes from 50 mm<sup>2</sup> to 150 mm<sup>2</sup>.

The connecting cables are able to run through several SMISLINE socket rows. The connection is safe and user-friendly. This allows the full flexibility of the 250 A SMISLINE system to be exploited to a greater extent. The new incoming terminal block is also able to cope with the higher mechanical forces that occur with a cable connection up to 150 mm<sup>2</sup>. The 250 A power bar system is now also certified to UL 508.

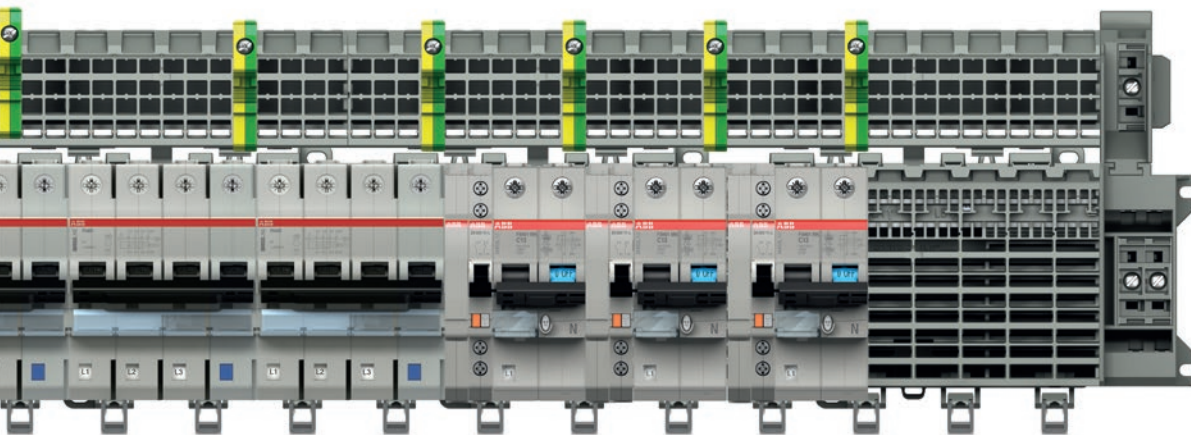

#### **SMISLINE TP Power Bar System**

- Lateral power supply with 250 A for IEC 61439-6 and UL 508 applications. The additional socket is not UL-approved.
- Power supply solution with threaded connection for a ring lug up to 150 mm<sup>2</sup>
- Safe and strong option for connection to power supply circuit breaker
- Practice-oriented set-up and connection in distribution systems for vertical or horizontal applications
- Simple and quick assembly
- Devices can be arranged on the system in any order
- Systems set up vertically and in parallel: each with one power supply



# Absolutely safe without protective equipment

## The SMISLINE TP principle taken further

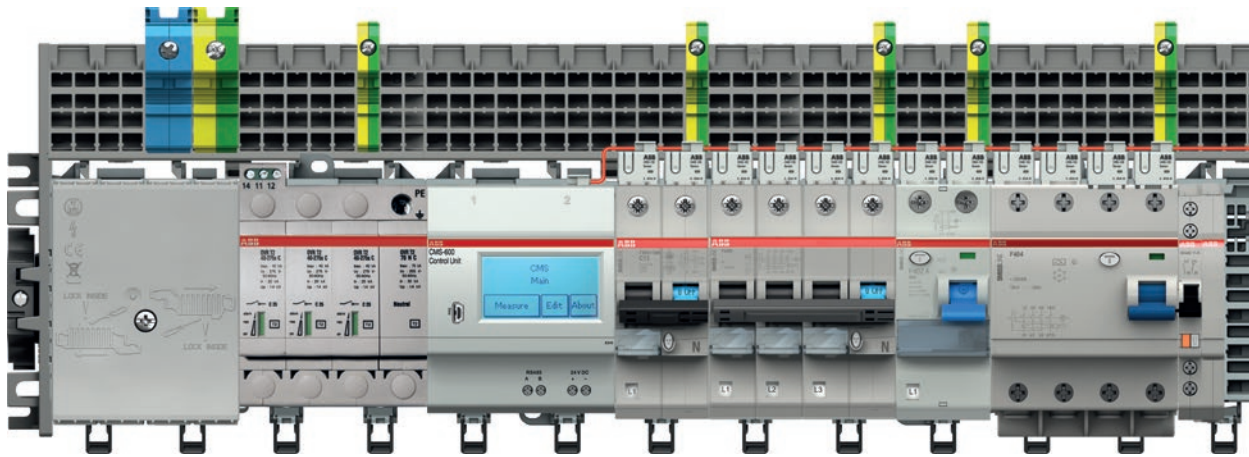

### The ingenious Click system

Using the SMISLINE TP system's unique SMISS CLICK function, five different protective devices can easily be plugged into one pluggable socket system with integrated busbars. In this way, the SMISLINE system allows the uncomplicated, modular, flexible distribution of power. Plugging in the devices quickly and without problems is essential for time-saving, cost-effective planning and execution.

### Current measurement system

The CMS is a system for current measurement of electrical lines. The system consists of a Control Unit and sensors with different measurement ranges (20 A, 40 A, 80 A). The sensors measure alternating, direct and mixed currents (TRMS). The sensors get connected to the Control Unit by a flat cable. You can remotely query the measurement data via a RS485 interface (Modbus RTU).



#### The RANGE

- Miniature circuit breaker 1-, 2-, 3- and 4-pole
- Residual current circuit breaker 2- and 4-pole
- Residual current operated circuit breaker with overcurrent protection
- Surge arrester type 2
- Switch disconnector
- Motor protection switch
- Busbar system, contact rails max. 125 A; incoming system with max. 250 A and Power Bar System contact rails max. 250 A; incoming system with max. 400 A
- Wide range of accessories

#### SMISLINE TP at a glance

- **Safe:** load-free plugging in and unplugging possible under power
- **Flexible:** rapid replacement, easy expansion, mixed-pole layout possible
- **Economical:** saves time and space thanks to the plug-in technology

# Six protection devices in one system

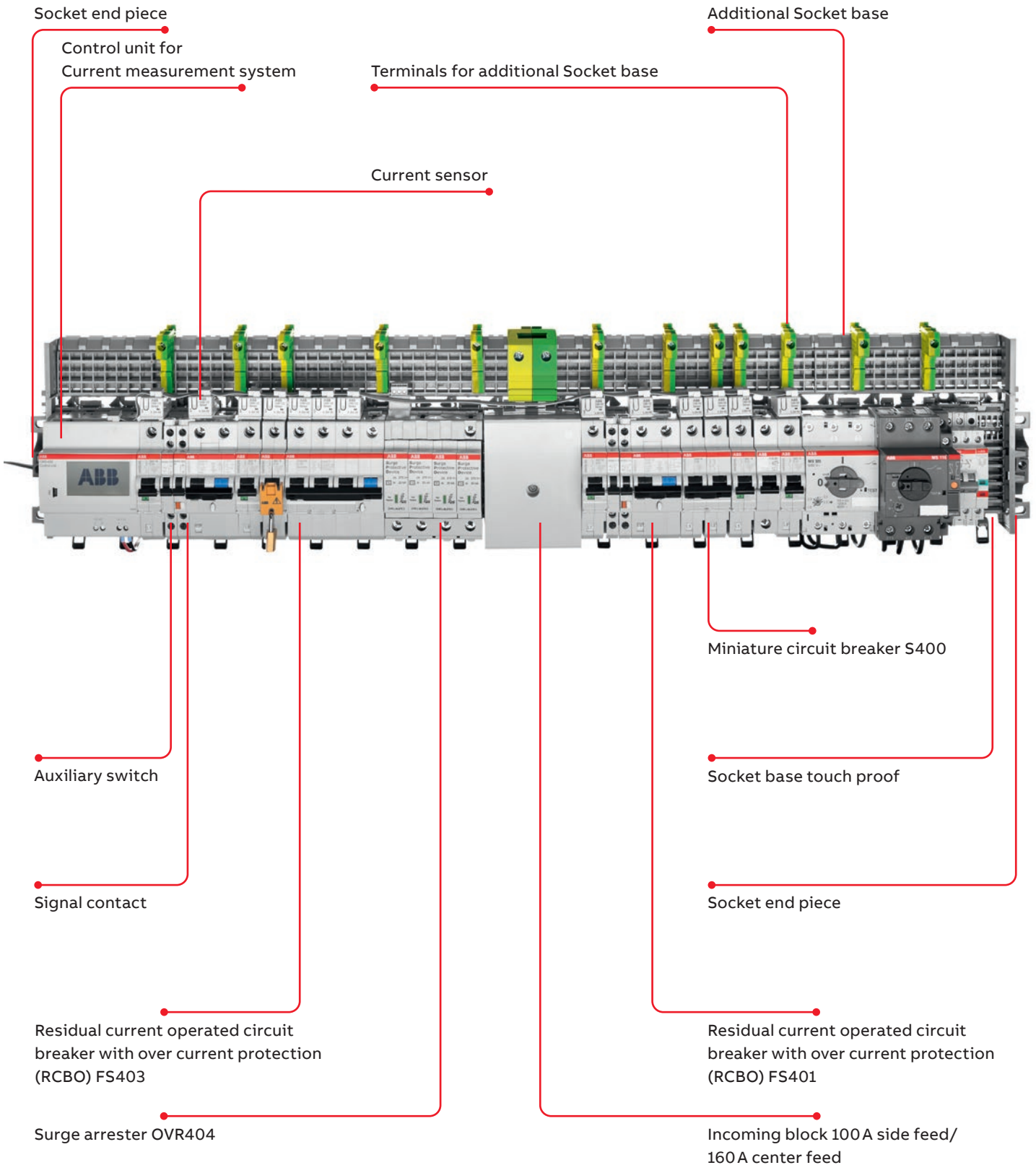

---

# Table of contents

<b>01. Miniature circuit breaker (MCB) S400</b>	12
<b>02. Residual current operated circuit breaker with over current protection (RCBO) FS401, FS403</b>	36
<b>03. Residual Current Circuit Breaker (RCCB) F402, F404</b>	44
<b>04. Surge arrester (SPD) OVR404</b>	51
<b>05. Switch disconnecter</b>	54
<b>06. Accessories</b>	57
<b>07. Busbar system 125 A</b>	61
<b>08. Busbar system Power Bar 250 A</b>	84
<b>09. Direct Feed 250 A</b>	94

# Miniature circuit breaker (MCB)

## Electrical installation solutions for buildings

New, patented bidirectional terminal with captive screws for maximum comfort, safety and flexibility. The connection takes place in two chambers (35 mm<sup>2</sup> and 6 mm<sup>2</sup>). Two conductors with the same cross-section can be connected in each chamber.

Reliable recognition of the switching status through the new red/green position indicating device that shows the position of the inner contacts.

Laser printing for scratch- and solvent-resistant identification marking

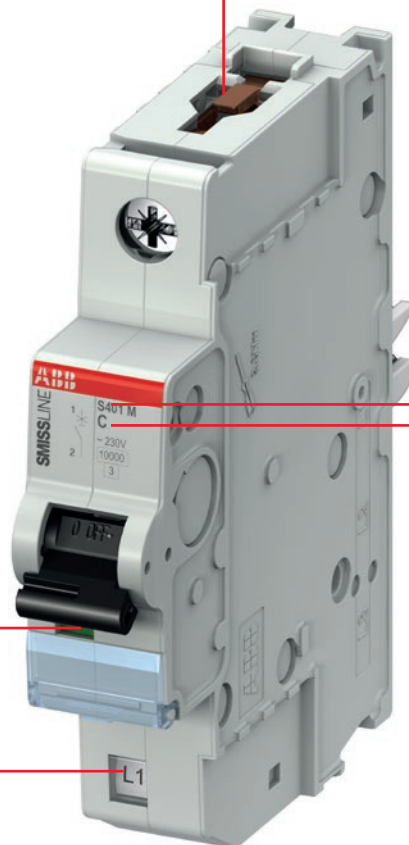

Pole conductor indicator changes when the contact is moved to the rear of the device

Tripping characteristics B, C, D, K, UCC and UCZ.

Rated breaking capacity of 6 kA to 10 kA according to IEC/EN 60898-1 (B, C, D) and 6 kA to 25 kA according to IEC/EN 60947-2 (C and K)

For S400P

2...16 A, AC 240/415 V: 40 kA  
 20...40 A, AC 240/415 V: 30 kA  
 50...63 A, AC 240/415 V: 20 kA  
 according to IEC/EN 60947-2

## Miniature circuit breaker (MCB) for IEC

### S400E technical features







—  
When installed correctly the requirements of EN/IEC 61439-2 are met.

<b>S400E</b>	
<b>General data</b>	
Tripping characteristics	B,C
Poles	1P, 1P+NP, 2P, 3P, 3P+NP
Rated current $I_n$	6 A ... 63 A
Rated frequency $f$	50/60 Hz
Rated insulation voltage $U_i$ acc. to DIN EN 60664-1	440 VAC
Rated impulse withstand voltage $U_{imp.}$ (1.2/50 $\mu$ s)	4 kV
Overvoltage category	III
Pollution degree	3
<b>Data acc. to IEC/EN 60898-1</b>	
Rated operational voltage $U_e$	1P: 230/400 VAC; 1P+NP: 230 VAC ; 2...3P: 400 VAC; 3P+NP: 400 VAC
Min. operating voltage	12 VAC
Rated short-circuit capacity $I_{cn}$	10 kA
Energy limiting class	3
Reference Ambient Air Temperature for Overload Tripping	B, C, D: 30°C
<b>Mechanical Data</b>	
Classification acc. To NF F 126-101, NF F 16-102	Acc. to I2/F3
IP Code	IP20, IP40 in enclosure with cover
Endurance	Electrical endurance: 10 000 ops Mechanical endurance: 10 000 ops
Shock resistance acc. to IEC/EN 61373	5 g – 30 ms, 3 shocks
Vibration resistance acc. to IEC/EN 60068-2-6	2 ... 13.2 Hz / 1 mm 13.2 ... 100 Hz / 0.7 g, 5 cycles 5 ... 150 ... 5 Hz / 1 g, 4 waves
Ambient temperature	–25 ... +60°C
Storage temperature	–40 ... +70°C
<b>Installation</b>	
Terminal type	Failsafe bi-directional cylinder-lift terminal (shock protected)
Terminal rigid IEC connections (solid/stranded)	Single: 0.75 ... 35 mm <sup>2</sup> (front slot), 0.75 ... 6 mm <sup>2</sup> (rear slot) Multiple: 2x0.75 ... 10 mm <sup>2</sup> (front slot), 2x0.75 ... 6 mm <sup>2</sup> (rear slot), with cables of same type and size
Terminal flexible IEC connections	Single: 0.75 ... 25 mm <sup>2</sup> (front side), 0.75 ... 6 mm <sup>2</sup> (rear slot) Multiple: 2x0.75 ... 10 mm <sup>2</sup> (front slot), 2x0.75 ... 6 mm <sup>2</sup> (rear slot), with cables of same type and size
Tightening torque	2.8 Nm
Screwdriver	No. 2 Pozidrive
Mounting	Plug in on bus bar system SMISLINE
Mounting position	Any
Supply	Any
<b>Dimensions and weight</b>	
Pole dimensions (HxDxW)	91 x 18 x 82
Pole weight	110 g

## Miniature circuit breaker (MCB)

### S400E 6 kA



B according to EN 60898-1

	$I_{cn}$ [kA]	$I_n$ [A]	Type name	ABB IT number	EAN number 761 227	Pack- aging unit	Module	Weight in grams
 	6	6	S401E-B6	2CCS551001R0065	010 1009	10	1	110
	6	8	S401E-B8	2CCS551001R0085	010 8442	10	1	110
	6	10	S401E-B10	2CCS551001R0105	010 1016	10	1	110
	6	13	S401E-B13	2CCS551001R0135	010 1023	10	1	110
	6	16	S401E-B16	2CCS551001R0165	010 1030	10	1	110
	6	20	S401E-B20	2CCS551001R0205	010 1047	10	1	110
	6	25	S401E-B25	2CCS551001R0255	010 1054	10	1	110
	6	32	S401E-B32	2CCS551001R0325	010 1061	10	1	110
	6	40	S401E-B40	2CCS551001R0405	010 1078	10	1	110
	6	50	S401E-B50	2CCS551001R0505	010 1085	10	1	110
6	63	S401E-B63	2CCS551001R0635	010 1092	10	1	110	
 	6	6	S402E-B6	2CCS552001R0065	010 1771	5	2	221
	6	8	S402E-B8	2CCS552001R0085	010 8459	5	2	221
	6	10	S402E-B10	2CCS552001R0105	010 1788	5	2	221
	6	13	S402E-B13	2CCS552001R0135	010 1795	5	2	221
	6	16	S402E-B16	2CCS552001R0165	010 1801	5	2	221
	6	20	S402E-B20	2CCS552001R0205	010 1818	5	2	221
	6	25	S402E-B25	2CCS552001R0255	010 1825	5	2	221
	6	32	S402E-B32	2CCS552001R0325	010 1832	5	2	221
	6	40	S402E-B40	2CCS552001R0405	010 1849	5	2	221
	6	50	S402E-B50	2CCS552001R0505	010 1856	5	2	221
6	63	S402E-B63	2CCS552001R0635	010 1863	5	2	221	
 	6	6	S403E-B6	2CCS553001R0065	010 2549	4	3	322
	6	8	S403E-B8	2CCS553001R0085	010 8466	4	3	322
	6	10	S403E-B10	2CCS553001R0105	010 2556	4	3	322
	6	13	S403E-B13	2CCS553001R0135	010 2563	4	3	322
	6	16	S403E-B16	2CCS553001R0165	010 2570	4	3	322
	6	20	S403E-B20	2CCS553001R0205	010 2587	4	3	322
	6	25	S403E-B25	2CCS553001R0255	010 2594	4	3	322
	6	32	S403E-B32	2CCS553001R0325	010 2600	4	3	322
	6	40	S403E-B40	2CCS553001R0405	010 2617	4	3	322
	6	50	S403E-B50	2CCS553001R0505	010 2624	4	3	322
6	63	S403E-B63	2CCS553001R0635	010 2631	4	3	322	

## Miniature circuit breaker (MCB)

### S400E 6 kA

C according to EN 60898-1





	$I_{cn}$ [kA]	$I_n$ [A]	Type name	ABB IT number	EAN number 761 227	Pack- aging unit	Module	Weight in grams
	6	6	S401E-C6	2CCS551001R0064	010 1108	10	1	110
	6	8	S401E-C8	2CCS551001R0084	010 1115	10	1	110
	6	10	S401E-C10	2CCS551001R0104	010 1122	10	1	110
	6	13	S401E-C13	2CCS551001R0134	010 1139	10	1	110
	6	16	S401E-C16	2CCS551001R0164	010 1146	10	1	110
	6	20	S401E-C20	2CCS551001R0204	010 1153	10	1	110
	6	25	S401E-C25	2CCS551001R0254	010 1160	10	1	110
	6	32	S401E-C32	2CCS551001R0324	010 1177	10	1	110
	6	40	S401E-C40	2CCS551001R0404	010 1184	10	1	110
	6	50	S401E-C50	2CCS551001R0504	010 1191	10	1	110
6	63	S401E-C63	2CCS551001R0634	010 1207	10	1	110	
	6	6	S402E-C6	2CCS552001R0064	010 1870	5	2	221
	6	8	S402E-C8	2CCS552001R0084	010 1887	5	2	221
	6	10	S402E-C10	2CCS552001R0104	010 1894	5	2	221
	6	13	S402E-C13	2CCS552001R0134	010 1900	5	2	221
	6	16	S402E-C16	2CCS552001R0164	010 1917	5	2	221
	6	20	S402E-C20	2CCS552001R0204	010 1924	5	2	221
	6	25	S402E-C25	2CCS552001R0254	010 1931	5	2	221
	6	32	S402E-C32	2CCS552001R0324	010 1948	5	2	221
	6	40	S402E-C40	2CCS552001R0404	010 1955	5	2	221
	6	50	S402E-C50	2CCS552001R0504	010 1962	5	2	221
6	63	S402E-C63	2CCS552001R0634	010 1979	5	2	221	
	6	6	S403E-C6	2CCS553001R0064	010 2648	4	3	322
	6	8	S403E-C8	2CCS553001R0084	010 2655	4	3	322
	6	10	S403E-C10	2CCS553001R0104	010 2662	4	3	322
	6	13	S403E-C13	2CCS553001R0134	010 2679	4	3	322
	6	16	S403E-C16	2CCS553001R0164	010 2686	4	3	322
	6	20	S403E-C20	2CCS553001R0204	010 2693	4	3	322
	6	25	S403E-C25	2CCS553001R0254	010 2709	4	3	322
	6	32	S403E-C32	2CCS553001R0324	010 2716	4	3	322
	6	40	S403E-C40	2CCS553001R0404	010 2723	4	3	322
	6	50	S403E-C50	2CCS553001R0504	010 2730	4	3	322
6	63	S403E-C63	2CCS553001R0634	010 2747	4	3	322	



## Miniature circuit breaker (MCB)

S400E with protected neutral 6 kA

C according to EN 60898-1

	$I_{cn}$ [kA]	$I_n$ [A]	Type name	ABB IT number	EAN number 761 227	Pack- aging unit	Module	Weight in grams
 	6	10	S401E-C10NP	2CCS551103R8104	144 2750	5	2	221
	6	13	S401E-C13NP	2CCS551103R8134	144 2767	5	2	221
	6	16	S401E-C16NP	2CCS551103R8164	144 2774	5	2	221
	6	20	S401E-C20NP	2CCS551103R8204	144 2781	5	2	221
	6	25	S401E-C25NP	2CCS551103R8254	144 2798	5	2	221
	6	32	S401E-C32NP	2CCS551103R8324	144 2804	5	2	221
	6	40	S401E-C40NP	2CCS551103R8404	144 2811	5	2	221
	6	50	S401E-C50NP	2CCS551103R8504	144 2828	5	2	221
	6	63	S401E-C63NP	2CCS551103R8634	144 2835	5	2	221
 	6	10	S403E-C10NP	2CCS553103R8104	144 2842	2	4	428
	6	13	S403E-C13NP	2CCS553103R8134	144 2859	2	4	428
	6	16	S403E-C16NP	2CCS553103R8164	144 2866	2	4	428
	6	20	S403E-C20NP	2CCS553103R8204	144 2873	2	4	428
	6	25	S403E-C25NP	2CCS553103R8254	144 2880	2	4	428
	6	32	S403E-C32NP	2CCS553103R8324	144 2897	2	4	428
	6	40	S403E-C40NP	2CCS553103R8404	144 2903	2	4	428
	6	50	S403E-C50NP	2CCS553103R8504	144 2910	2	4	428
	6	63	S403E-C63NP	2CCS553103R8634	144 3009	2	4	428

## Miniature circuit breaker (MCB) for IEC

### S400M technical features

When installed correctly the requirements of EN/IEC 61439-2 are met.

<b>S400M</b>	
<b>General data</b>	
Tripping characteristics	B,C,D,K
Poles	1P, 1P+NP, 2P, 3P, 3P+NP
Rated current $I_n$	0.5A... 63A
Rated frequency $f$	50/60Hz
Rated insulation voltage $U_i$ acc. to DIN EN 60664-1	440VAC
Rated impulse withstand voltage $U_{imp}$ . (1.2/50 $\mu$ s)	4kV
Overvoltage category	III
Pollution degree	3
<b>Data acc. to IEC/EN 60898-1</b>	
Rated operational voltage $U_e$	1P: 230/400VAC; 1P+NP: 230 VAC ; 2...3P: 400VAC; 3P+NP: 400VAC
Min. operating voltage	12 VAC
Rated short-circuit capacity $I_{cn}$	10kA
Energy limiting class	3
Reference Ambient Air Temperature for Overload Tripping	B, C, D: 30°C
<b>Data acc. to IEC/EN 60947-2</b>	
Rated operational voltage $U_e$	1P: 240VAC; 1P+N: 240VAC; 2... 4P: 415VAC; 3P+N: 415VAC; 254/440V; 1P 60 V DC; 2P 125 V DC ( $U_{max}$ )
Min. operating voltage	12 V AC-12 V DC
Rated ultimate short-circuit capacity $I_{cu}$	25kA (0,5 up to 16A, 240/415V); 0,5 to 2A 50kA on request 15kA (20 up to 63A, 240/415V) 15kA (0,5 up to 16A, 254/440V) 6kA (20 up to 63A, 254/440V)
Rated service short-circuit capacity $I_{cs}$	15kA (0,5 up to 16A, 240/415V) 7,5kA (20 up to 63A, 240/415V) 6kA (0,5 up to 16A, 254/440V) 3kA (20 up to 63A, 254/440V)
Reference Ambient Air Temperature for Overload Tripping	C: 30°C K: 40°C
<b>Mechanical Data</b>	
Classification acc. To NF F 126-101, NF F 16-102	Acc. to I2/F3
IP Code	IP20, IP40 in enclosure with cover
Endurance	Electrical endurance: 10000ops Mechanical endurance: 10000ops
Shock resistance acc. to IEC/EN 61373	5g – 30ms, 3 shocks
Vibration resistance acc. to IEC/EN 60068-2-6	2...13,2 Hz / 1 mm 13,2...100 Hz / 0,7 g, 5 cycles 5...150...5 Hz / 1 g, 4 waves
Ambient temperature	-25... +60°C
Storage temperature	-40... +70°C
<b>Installation</b>	
Terminal type	Failsafe bi-directional cylinder-lift terminal (shock protected)
Terminal rigid IEC connections (solid/stranded)	Single: 0.75 ... 35 mm <sup>2</sup> (front slot), 0.75 ... 6 mm <sup>2</sup> (rear slot) Multiple: 2x0.75 ... 10mm <sup>2</sup> (front slot), 2x0.75 ... 6mm <sup>2</sup> (rear slot), with cables of same type and size
Terminal flexible IEC connections	Single: 0.75 ... 25 mm <sup>2</sup> (front side), 0.75 ... 6 mm <sup>2</sup> (rear slot) Multiple: 2x0.75 ... 10mm <sup>2</sup> (front slot), 2x0.75 ... 6mm <sup>2</sup> (rear slot), with cables of same type and size
Tightening torque	2.8 Nm
Screwdriver	No. 2 Pozidrive
Mounting	Plug in on bus bar system SMISLINE
Mounting position	Any
Supply	Any
<b>Dimensions and weight</b>	
Pole dimensions (HxDxW)	91 x 18 x 82
Pole weight	110g

## Miniature circuit breaker (MCB)





### Technical data S400M-UC technical features

S400M-UC	
<b>General data</b>	
Tripping characteristics	UCC, UCZ
Standards	IEC/EN 60947-2
Poles	1P, 2P
Rated current $I_n$	0.5A... 63A
Rated frequency f	50/60 Hz
Rated insulation voltage $U_i$ acc. to DIN EN 60664-1	440VAC
Rated impulse withstand voltage $U_{imp.}$ (1.2/50 $\mu$ s)	4kV
Overvoltage category	III
Pollution degree	3
<b>Data acc. to IEC/EN 60947-2</b>	
Rated operational voltage $U_e$	110 VDC (1pole) 220VDC (poles 1; 2) 440VDC (2pole) 230/400 VAC (poles 1; 2)
Min. operating voltage	12VAC-12VDC
Rated ultimate short-circuit capacity $I_{cu}$	10kA (0,5 up to 63A, 220VDC 1pole) 20kA (0,5 up to 63A, 110VDC 1pole) 25kA (0,5 up to 63A, 220VDC 2pole) 10kA (0,5 up to 63A, 440VDC 2pole) 10kA (0,5 up to 63A, 230/400VAC)
Rated service short-circuit capacity $I_{cs}$	10kA (0,5 up to 63A, 220VDC 1pole) 10kA (0,5 up to 63A, 110VDC 1pole) 20kA (0,5 up to 63A, 220VDC 2pole) 10kA (0,5 up to 63A, 440VDC 2pole) 6kA (0,5 up to 63A, 230/400VAC)
Reference Ambient Air Temperature for Overload Tripping	30°C
<b>Mechanical Data</b>	
IP Code	IP20B, IP40 in enclosure with cover
Endurance	Electrical endurance: 10000ops Mechanical endurance: 10000ops
Shock resistance acc. to IEC/EN 61373	5g – 30ms, 3 shocks
Vibration resistance acc. to IEC/EN 60068-2-6	2...13.2 Hz / 1 mm 13.2...100 Hz / 0.7 g, 5 cycles 5...150...5 Hz / 1 g, 4 waves
Environmental conditions (damp heat) acc. to IEC/EN 60068-2-30	2 cycles with 55°C/90–96% and 25°C/95–100%
Ambient temperature	–25... +60°C
Storage temperature	–40... +70°C
<b>Installation</b>	
Top terminal type	Failsafe bi-directional cylinder-lift terminal with double slot 35/10mm <sup>2</sup>
Top terminal rigid IEC connections (solid/stranded)	Single: 0.75 ... 35mm <sup>2</sup> (front slot), 0.75 ... 6mm <sup>2</sup> (rear slot) Multiple: 2x0.75 ... 10mm <sup>2</sup> (front slot), 2x0.75 ... 6mm <sup>2</sup> (rear slot), with cables of same type and size
Top terminal flexible IEC connections	Single: 0.75 ... 25mm <sup>2</sup> (front side), 0.75 ... 6mm <sup>2</sup> (rear slot) Multiple: 2x0.75 ... 10mm <sup>2</sup> (front slot), 2x0.75 ... 6mm <sup>2</sup> (rear slot), with cables of same type and size
Tightening torque	2.8 Nm
Screwdriver	No. 2 Pozidrive
Mounting	plug in on bus bar system SMISSLINE
Mounting position	any
Supply	any
<b>Dimensions and weight</b>	
Pole dimensions (HxDxW)	91 x 18 x 82
Pole weight	110g

## Miniature circuit breaker (MCB)

S400M-B,  $I_{cn} = 10 \text{ kA}$

B according to EN 60898-1



	$I_{cn}$ [kA]	$I_n$ [A]	Type name	ABB IT number	EAN number 761 227	Pack- aging unit	Module	Weight in grams
	10	4	S401M-B4	2CCS571001R0045	010 1214	10	1	110
	10	6	S401M-B6	2CCS571001R0065	010 1221	10	1	110
	10	8	S401M-B8	2CCS571001R0085	010 8411	10	1	110
	10	10	S401M-B10	2CCS571001R0105	010 1238	10	1	110
	10	13	S401M-B13	2CCS571001R0135	010 1245	10	1	110
	10	16	S401M-B16	2CCS571001R0165	010 1252	10	1	110
	10	20	S401M-B20	2CCS571001R0205	010 1269	10	1	110
	10	25	S401M-B25	2CCS571001R0255	010 1276	10	1	110
	10	32	S401M-B32	2CCS571001R0325	010 1283	10	1	110
	10	40	S401M-B40	2CCS571001R0405	010 1290	10	1	110
	10	4	S402M-B4	2CCS572001R0045	010 1986	5	2	221
	10	6	S402M-B6	2CCS572001R0065	010 1993	5	2	221
	10	8	S402M-B8	2CCS572001R0085	010 8428	5	2	221
	10	10	S402M-B10	2CCS572001R0105	010 2006	5	2	221
	10	13	S402M-B13	2CCS572001R0135	010 2013	5	2	221
	10	16	S402M-B16	2CCS572001R0165	010 2020	5	2	221
	10	20	S402M-B20	2CCS572001R0205	010 2037	5	2	221
	10	25	S402M-B25	2CCS572001R0255	010 2044	5	2	221
	10	32	S402M-B32	2CCS572001R0325	010 2051	5	2	221
	10	40	S402M-B40	2CCS572001R0405	010 2068	5	2	221
	10	4	S403M-B4	2CCS573001R0045	010 2754	4	3	322
	10	6	S403M-B6	2CCS573001R0065	010 2761	4	3	322
	10	8	S403M-B8	2CCS573001R0085	010 8435	4	3	322
	10	10	S403M-B10	2CCS573001R0105	010 2778	4	3	322
	10	13	S403M-B13	2CCS573001R0135	010 2785	4	3	322
	10	16	S403M-B16	2CCS573001R0165	010 2792	4	3	322
	10	20	S403M-B20	2CCS573001R0205	010 2808	4	3	322
	10	25	S403M-B25	2CCS573001R0255	010 2815	4	3	322
	10	32	S403M-B32	2CCS573001R0325	010 2822	4	3	322
	10	40	S403M-B40	2CCS573001R0405	010 2839	4	3	322
	10	50	S403M-B50	2CCS573001R0505	010 2846	4	3	322
	10	63	S403M-B63	2CCS573001R0635	010 2853	4	3	322

Ordering details for auxiliary switch and signal contacts on page 56–57

## Miniature circuit breaker (MCB)

S400M-C,  $I_{cn} = 10 \text{ kA}$ ,  $I_{cu} = 15 \dots 25 \text{ kA}$



C according to EN 60898-1 and IEC/EN 60947-2

	$I_{cu}$ EN 60947-2 [kA]	$I_{cn}$ EN 60898-1 [kA]	$I_n$ [A]	Type name	ABB IT number	EAN number 761 227	Pack- aging unit	Module	Weight in grams
	25	10	0.5	S401M-C0.5	2CCS571001R0984	010 1320	10	1	110
	25	10	1	S401M-C1	2CCS571001R0014	010 1337	10	1	110
	25	10	1.6	S401M-C1.6	2CCS571001R0974	010 1344	10	1	110
	25	10	2	S401M-C2	2CCS571001R0024	010 1351	10	1	110
	25	10	3	S401M-C3	2CCS571001R0034	010 1368	10	1	110
	25	10	4	S401M-C4	2CCS571001R0044	010 1375	10	1	110
	25	10	6	S401M-C6	2CCS571001R0064	010 1382	10	1	110
	25	10	8	S401M-C8	2CCS571001R0084	010 1399	10	1	110
	25	10	10	S401M-C10	2CCS571001R0104	010 1405	10	1	110
	25	10	13	S401M-C13	2CCS571001R0134	010 1412	10	1	110
	25	10	16	S401M-C16	2CCS571001R0164	010 1429	10	1	110
	15	10	20	S401M-C20	2CCS571001R0204	010 1436	10	1	110
	15	10	25	S401M-C25	2CCS571001R0254	010 1443	10	1	110
	15	10	32	S401M-C32	2CCS571001R0324	010 1450	10	1	110
	15	10	40	S401M-C40	2CCS571001R0404	010 1467	10	1	110
	15	10	50	S401M-C50	2CCS571001R0504	010 1474	10	1	110
15	10	63	S401M-C63	2CCS571001R0634	010 1481	10	1	110	
	25	10	0.5	S402M-C0.5	2CCS572001R0984	010 2099	5	2	221
	25	10	1	S402M-C1	2CCS572001R0014	010 2105	5	2	221
	25	10	1.6	S402M-C1.6	2CCS572001R0974	010 2112	5	2	221
	25	10	2	S402M-C2	2CCS572001R0024	010 2129	5	2	221
	25	10	3	S402M-C3	2CCS572001R0034	010 2136	5	2	221
	25	10	4	S402M-C4	2CCS572001R0044	010 2143	5	2	221
	25	10	6	S402M-C6	2CCS572001R0064	010 2150	5	2	221
	25	10	8	S402M-C8	2CCS572001R0084	010 2167	5	2	221
	25	10	10	S402M-C10	2CCS572001R0104	010 2174	5	2	221
	25	10	13	S402M-C13	2CCS572001R0134	010 2181	5	2	221
	25	10	16	S402M-C16	2CCS572001R0164	010 2198	5	2	221
	15	10	20	S402M-C20	2CCS572001R0204	010 2204	5	2	221
	15	10	25	S402M-C25	2CCS572001R0254	010 2211	5	2	221
	15	10	32	S402M-C32	2CCS572001R0324	010 2228	5	2	221
	15	10	40	S402M-C40	2CCS572001R0404	010 2235	5	2	221
	15	10	50	S402M-C50	2CCS572001R0504	010 2242	5	2	221
15	10	63	S402M-C63	2CCS572001R0634	010 2259	5	2	221	
	25	10	0.5	S403M-C0.5	2CCS573001R0984	010 2860	4	3	322
	25	10	1	S403M-C1	2CCS573001R0014	010 2877	4	3	322
	25	10	1.6	S403M-C1.6	2CCS573001R0974	010 2884	4	3	322
	25	10	2	S403M-C2	2CCS573001R0024	010 2891	4	3	322
	25	10	3	S403M-C3	2CCS573001R0034	010 2907	4	3	322
	25	10	4	S403M-C4	2CCS573001R0044	010 2914	4	3	322
	25	10	6	S403M-C6	2CCS573001R0064	010 2921	4	3	322
	25	10	8	S403M-C8	2CCS573001R0084	010 2938	4	3	322
	25	10	10	S403M-C10	2CCS573001R0104	010 2945	4	3	322
	25	10	13	S403M-C13	2CCS573001R0134	010 2952	4	3	322
	25	10	16	S403M-C16	2CCS573001R0164	010 2969	4	3	322
	15	10	20	S403M-C20	2CCS573001R0204	010 2976	4	3	322
	15	10	25	S403M-C25	2CCS573001R0254	010 2983	4	3	322
	15	10	32	S403M-C32	2CCS573001R0324	010 2990	4	3	322
	15	10	40	S403M-C40	2CCS573001R0404	010 3003	4	3	322
	15	10	50	S403M-C50	2CCS573001R0504	010 3010	4	3	322
15	10	63	S403M-C63	2CCS573001R0634	010 3027	4	3	322	

## Miniature circuit breaker (MCB)

S400M-D,  $I_{cn} = 10 \text{ kA}$

D according to EN 60898-1



	$I_{cn}$ [kA]	$I_n$ [A]	Type name	ABB IT number	EAN number 761 227	Pack- aging unit	Module	Weight in grams
	10	6	S401M-D6	2CCS571001R0061	010 1498	10	1	110
	10	8	S401M-D8	2CCS571001R0081	010 1504	10	1	110
	10	10	S401M-D10	2CCS571001R0101	010 1511	10	1	110
	10	13	S401M-D13	2CCS571001R0131	010 1528	10	1	110
	10	16	S401M-D16	2CCS571001R0161	010 1535	10	1	110
	10	20	S401M-D20	2CCS571001R0201	010 1542	10	1	110
	10	25	S401M-D25	2CCS571001R0251	010 1559	10	1	110
	10	32	S401M-D32	2CCS571001R0321	010 1566	10	1	110
	10	40	S401M-D40	2CCS571001R0401	010 1573	10	1	110
	10	50	S401M-D50	2CCS571001R0501	010 1580	10	1	110
	10	63	S401M-D63	2CCS571001R0631	010 1597	10	1	110
	10	6	S402M-D6	2CCS572001R0061	010 2266	5	2	221
	10	8	S402M-D8	2CCS572001R0081	010 2273	5	2	221
	10	10	S402M-D10	2CCS572001R0101	010 2280	5	2	221
	10	13	S402M-D13	2CCS572001R0131	010 2297	5	2	221
	10	16	S402M-D16	2CCS572001R0161	010 2303	5	2	221
	10	20	S402M-D20	2CCS572001R0201	010 2310	5	2	221
	10	25	S402M-D25	2CCS572001R0251	010 2327	5	2	221
	10	32	S402M-D32	2CCS572001R0321	010 2334	5	2	221
	10	40	S402M-D40	2CCS572001R0401	010 2341	5	2	221
	10	50	S402M-D50	2CCS572001R0501	010 2358	5	2	221
	10	63	S402M-D63	2CCS572001R0631	010 2365	5	2	221
	10	6	S403M-D6	2CCS573001R0061	010 3034	4	3	322
	10	8	S403M-D8	2CCS573001R0081	010 3041	4	3	322
	10	10	S403M-D10	2CCS573001R0101	010 3058	4	3	322
	10	13	S403M-D13	2CCS573001R0131	010 3065	4	3	322
	10	16	S403M-D16	2CCS573001R0161	010 3072	4	3	322
	10	20	S403M-D20	2CCS573001R0201	010 3089	4	3	322
	10	25	S403M-D25	2CCS573001R0251	010 3096	4	3	322
	10	32	S403M-D32	2CCS573001R0321	010 3102	4	3	322
	10	40	S403M-D40	2CCS573001R0401	010 3119	4	3	322
	10	50	S403M-D50	2CCS573001R0501	010 3126	4	3	322
	10	63	S403M-D63	2CCS573001R0631	010 3133	4	3	322

Ordering details for auxiliary switch and signal contacts on page 56–57

## Miniature circuit breaker (MCB)

S400M-K,  $I_{cu} = 15 \dots 25 \text{ kA}$





K according to IEC/EN 60947-2

	$I_{cn}$ [kA]	$I_n$ [A]	Type name	ABB IT number	EAN number 761 227	Pack- aging unit	Module	Weight in grams
	25	0.5	S401M-K0.5	2CCS571001R0157	010 1603	10	1	110
	25	1	S401M-K1	2CCS571001R0217	010 1610	10	1	110
	25	1.6	S401M-K1.6	2CCS571001R0257	010 1627	10	1	110
	25	2	S401M-K2	2CCS571001R0277	010 1634	10	1	110
	25	3	S401M-K3	2CCS571001R0317	010 1641	10	1	110
	25	4	S401M-K4	2CCS571001R0337	010 1658	10	1	110
	25	6	S401M-K6	2CCS571001R0377	010 1665	10	1	110
	25	8	S401M-K8	2CCS571001R0407	010 1672	10	1	110
	25	10	S401M-K10	2CCS571001R0427	010 1689	10	1	110
	25	13	S401M-K13	2CCS571001R0447	010 1696	10	1	110
	25	16	S401M-K16	2CCS571001R0467	010 1702	10	1	110
	15	20	S401M-K20	2CCS571001R0487	010 1719	10	1	110
	15	25	S401M-K25	2CCS571001R0517	010 1726	10	1	110
	15	32	S401M-K32	2CCS571001R0537	010 1733	10	1	110
	15	40	S401M-K40	2CCS571001R0557	010 1740	10	1	110
15	50	S401M-K50	2CCS571001R0577	010 1757	10	1	110	
15	63	S401M-K63	2CCS571001R0597	010 1764	10	1	110	
	25	0.5	S402M-K0.5	2CCS572001R0157	010 2372	5	2	221
	25	1	S402M-K1	2CCS572001R0217	010 2389	5	2	221
	25	1.6	S402M-K1.6	2CCS572001R0257	010 2396	5	2	221
	25	2	S402M-K2	2CCS572001R0277	010 2402	5	2	221
	25	3	S402M-K3	2CCS572001R0317	010 2419	5	2	221
	25	4	S402M-K4	2CCS572001R0337	010 2426	5	2	221
	25	6	S402M-K6	2CCS572001R0377	010 2433	5	2	221
	25	8	S402M-K8	2CCS572001R0407	010 2440	5	2	221
	25	10	S402M-K10	2CCS572001R0427	010 2457	5	2	221
	25	13	S402M-K13	2CCS572001R0447	010 2464	5	2	221
	25	16	S402M-K16	2CCS572001R0467	010 2471	5	2	221
	15	20	S402M-K20	2CCS572001R0487	010 2488	5	2	221
	15	25	S402M-K25	2CCS572001R0517	010 2495	5	2	221
	15	32	S402M-K32	2CCS572001R0537	010 2501	5	2	221
	15	40	S402M-K40	2CCS572001R0557	010 2518	5	2	221
15	50	S402M-K50	2CCS572001R0577	010 2525	5	2	221	
15	63	S402M-K63	2CCS572001R0597	010 2532	5	2	221	
	25	0.5	S403M-K0.5	2CCS573001R0157	010 3140	4	3	322
	25	1	S403M-K1	2CCS573001R0217	010 3157	4	3	322
	25	1.6	S403M-K1.6	2CCS573001R0257	010 3164	4	3	322
	25	2	S403M-K2	2CCS573001R0277	010 3171	4	3	322
	25	3	S403M-K3	2CCS573001R0317	010 3188	4	3	322
	25	4	S403M-K4	2CCS573001R0337	010 3195	4	3	322
	25	6	S403M-K6	2CCS573001R0377	010 3201	4	3	322
	25	8	S403M-K8	2CCS573001R0407	010 3218	4	3	322
	25	10	S403M-K10	2CCS573001R0427	010 3225	4	3	322
	25	13	S403M-K13	2CCS573001R0447	010 3232	4	3	322
	25	16	S403M-K16	2CCS573001R0467	010 3249	4	3	322
	15	20	S403M-K20	2CCS573001R0487	010 3256	4	3	322
	15	25	S403M-K25	2CCS573001R0517	010 3263	4	3	322
	15	32	S403M-K32	2CCS573001R0537	010 3270	4	3	322
	15	40	S403M-K40	2CCS573001R0557	010 3287	4	3	322
15	50	S403M-K50	2CCS573001R0577	010 3294	4	3	322	
15	63	S403M-K63	2CCS573001R0597	010 3300	4	3	322	

## Miniature circuit breaker (MCB)

S400M-B with protected neutral  $I_{cn} = 10 \text{ kA}$

B according to EN 60898-1

	$I_{cn}$ [kA]	$I_n$ [A]	Type name	ABB IT number	EAN number 761 227	Pack- aging unit	Module	Weight in grams
 	10	6	S401M-B6NP	2CCS571103R8065	010 3317	5	2	221
	10	8	S401M-B8NP	2CCS571103R8085	010 8473	5	2	221
	10	10	S401M-B10NP	2CCS571103R8105	010 3324	5	2	221
	10	13	S401M-B13NP	2CCS571103R8135	010 3331	5	2	221
	10	16	S401M-B16NP	2CCS571103R8165	010 3348	5	2	221
	10	20	S401M-B20NP	2CCS571103R8205	010 3355	5	2	221
	10	25	S401M-B25NP	2CCS571103R8255	010 3362	5	2	221
	10	32	S401M-B32NP	2CCS571103R8325	010 3379	5	2	221
	10	40	S401M-B40NP	2CCS571103R8405	010 3386	5	2	221
	10	50	S401M-B50NP	2CCS571103R8505	010 3393	5	2	221
 	10	6	S403M-B6NP	2CCS573103R8065	010 3782	2	4	428
	10	8	S403M-B8NP	2CCS573103R8085	010 8510	2	4	428
	10	10	S403M-B10NP	2CCS573103R8105	010 3799	2	4	428
	10	13	S403M-B13NP	2CCS573103R8135	010 3805	2	4	428
	10	16	S403M-B16NP	2CCS573103R8165	010 3812	2	4	428
	10	20	S403M-B20NP	2CCS573103R8205	010 3829	2	4	428
	10	25	S403M-B25NP	2CCS573103R8255	010 3836	2	4	428
	10	32	S403M-B32NP	2CCS573103R8325	010 3843	2	4	428
	10	40	S403M-B40NP	2CCS573103R8405	010 3850	2	4	428
	10	50	S403M-B50NP	2CCS573103R8505	010 3867	2	4	428
10	63	S403M-B63NP	2CCS573103R8635	010 3874	2	4	428	

Ordering details for auxiliary switch and signal contacts on page 56–57





The neutral is protected with 100% of the nominal value of the pole conductor



## Miniature circuit breaker (MCB)

S400M-C with protected neutral  $I_{cn} = 10 \text{ kA}$ ,  $I_{cu} = 15 \dots 25 \text{ kA}$

C according to IEC/EN 60947-2

	$I_{cu}$ EN 60947-2 [kA]	$I_{cn}$ EN 60898-1 [kA]	$I_n$ [A]	Type name	ABB IT number	EAN number 761 227	Pack- aging unit	Module	Weight in grams
 	25	10	2	S401M-C2NP	2CCS571103R8024	010 8480	5	2	221
	25	10	3	S401M-C3NP	2CCS571103R8034	010 8497	5	2	221
	25	10	4	S401M-C4NP	2CCS571103R8044	010 8503	5	2	221
	25	10	6	S401M-C6NP	2CCS571103R8064	010 3416	5	2	221
	25	10	8	S401M-C8NP	2CCS571103R8084	010 3423	5	2	221
	25	10	10	S401M-C10NP	2CCS571103R8104	010 3430	5	2	221
	25	10	13	S401M-C13NP	2CCS571103R8134	010 3447	5	2	221
	25	10	16	S401M-C16NP	2CCS571103R8164	010 3454	5	2	221
	15	10	20	S401M-C20NP	2CCS571103R8204	010 3461	5	2	221
	15	10	25	S401M-C25NP	2CCS571103R8254	010 3478	5	2	221
	15	10	32	S401M-C32NP	2CCS571103R8324	010 3485	5	2	221
	15	10	40	S401M-C40NP	2CCS571103R8404	010 3492	5	2	221
	15	10	50	S401M-C50NP	2CCS571103R8504	010 3508	5	2	221
	15	10	63	S401M-C63NP	2CCS571103R8634	010 3515	5	2	221
	 	25	10	2	S403M-C2NP	2CCS573103R8024	010 8527	2	4
25		10	3	S403M-C3NP	2CCS573103R8034	010 8534	2	4	428
25		10	4	S403M-C4NP	2CCS573103R8044	010 8541	2	4	428
25		10	6	S403M-C6NP	2CCS573103R8064	010 3881	2	4	428
25		10	8	S403M-C8NP	2CCS573103R8084	010 3898	2	4	428
25		10	10	S403M-C10NP	2CCS573103R8104	010 3904	2	4	428
25		10	13	S403M-C13NP	2CCS573103R8134	010 3911	2	4	428
25		10	16	S403M-C16NP	2CCS573103R8164	010 3928	2	4	428
15		10	20	S403M-C20NP	2CCS573103R8204	010 3935	2	4	428
15		10	25	S403M-C25NP	2CCS573103R8254	010 3942	2	4	428
15		10	32	S403M-C32NP	2CCS573103R8324	010 3959	2	4	428
15		10	40	S403M-C40NP	2CCS573103R8404	010 3966	2	4	428
15		10	50	S403M-C50NP	2CCS573103R8504	010 3973	2	4	428
15		10	63	S403M-C63NP	2CCS573103R8634	010 3980	2	4	428





Ordering details for auxiliary switch and signal contacts on page 56–57

The neutral is protected with 100% of the nominal value of the pole conductor

## Miniature circuit breaker (MCB)

S400M-D with protected neutral  $I_{cn} = 10 \text{ kA}$

D according to EN 60898-1

	$I_{cn}$ [kA]	$I_n$ [A]	Type name	ABB IT number	EAN number 761 227	Pack- aging unit	Module	Weight in grams
 	10	10	S401M-D10NP	2CCS571103R8101	010 3522	5	2	221
	10	13	S401M-D13NP	2CCS571103R8131	010 3539	5	2	221
	10	16	S401M-D16NP	2CCS571103R8161	010 3546	5	2	221
	10	20	S401M-D20NP	2CCS571103R8201	010 3553	5	2	221
	10	25	S401M-D25NP	2CCS571103R8251	010 3560	5	2	221
	10	32	S401M-D32NP	2CCS571103R8321	010 3577	5	2	221
	10	40	S401M-D40NP	2CCS571103R8401	010 3584	5	2	221
	10	50	S401M-D50NP	2CCS571103R8501	010 3591	5	2	221
	10	63	S401M-D63NP	2CCS571103R8631	010 3607	5	2	221
 	10	10	S403M-D10NP	2CCS573103R8101	010 3997	2	4	428
	10	13	S403M-D13NP	2CCS573103R8131	010 4000	2	4	428
	10	16	S403M-D16NP	2CCS573103R8161	010 4017	2	4	428
	10	20	S403M-D20NP	2CCS573103R8201	010 4024	2	4	428
	10	25	S403M-D25NP	2CCS573103R8251	010 4031	2	4	428
	10	32	S403M-D32NP	2CCS573103R8321	010 4048	2	4	428
	10	40	S403M-D40NP	2CCS573103R8401	010 4055	2	4	428
	10	50	S403M-D50NP	2CCS573103R8501	010 4062	2	4	428
	10	63	S403M-D63NP	2CCS573103R8631	010 4079	2	4	428



Ordering details for auxiliary switch and signal contacts on page 56–57

The neutral is protected with 100% of the nominal value of the pole conductor

## Miniature circuit breaker (MCB)

S400M–K with protected neutral  $I_{cu} = 15 \dots 25 \text{ kA}$

K according to EN 60898-1

	$I_{cu}$ [kA]	$I_n$ [A]	Type name	ABB IT number	EAN number 761 227	Pack- aging unit	Module	Weight in grams
	25	0.5	S401M-K0.5NP	2CCS571103R8157	010 3614	5	2	221
	25	1	S401M-K1NP	2CCS571103R8217	010 3621	5	2	221
	25	1.6	S401M-K1.6NP	2CCS571103R8257	010 3638	5	2	221
	25	2	S401M-K2NP	2CCS571103R8277	010 3645	5	2	221
	25	3	S401M-K3NP	2CCS571103R8317	010 3652	5	2	221
	25	4	S401M-K4NP	2CCS571103R8337	010 3669	5	2	221
	25	6	S401M-K6NP	2CCS571103R8377	010 3676	5	2	221
	25	8	S401M-K8NP	2CCS571103R8407	010 3683	5	2	221
	25	10	S401M-K10NP	2CCS571103R8427	010 3690	5	2	221
	25	13	S401M-K13NP	2CCS571103R8447	010 3706	5	2	221
	25	16	S401M-K16NP	2CCS571103R8467	010 3713	5	2	221
	15	20	S401M-K20NP	2CCS571103R8487	010 3720	5	2	221
	15	25	S401M-K25NP	2CCS571103R8517	010 3737	5	2	221
	15	32	S401M-K32NP	2CCS571103R8537	010 3744	5	2	221
	15	40	S401M-K40NP	2CCS571103R8557	010 3751	5	2	221
15	50	S401M-K50NP	2CCS571103R8577	010 3768	5	2	221	
	15	63	S401M-K63NP	2CCS571103R8597	010 3775	5	2	221
	25	0.5	S403M-K0.5NP	2CCS573103R8157	010 4086	2	4	428
	25	1	S403M-K1NP	2CCS573103R8217	010 4093	2	4	428
	25	1.6	S403M-K1.6NP	2CCS573103R8257	010 4109	2	4	428
	25	2	S403M-K2NP	2CCS573103R8277	010 4116	2	4	428
	25	3	S403M-K3NP	2CCS573103R8317	010 4123	2	4	428
	25	4	S403M-K4NP	2CCS573103R8337	010 4130	2	4	428
	25	6	S403M-K6NP	2CCS573103R8377	010 4147	2	4	428
	25	8	S403M-K8NP	2CCS573103R8407	010 4154	2	4	428
	25	10	S403M-K10NP	2CCS573103R8427	010 4161	2	4	428
	25	13	S403M-K13NP	2CCS573103R8447	010 4178	2	4	428
	25	16	S403M-K16NP	2CCS573103R8467	010 4185	2	4	428
	15	20	S403M-K20NP	2CCS573103R8487	010 4192	2	4	428
	15	25	S403M-K25NP	2CCS573103R8517	010 4208	2	4	428
	15	32	S403M-K32NP	2CCS573103R8537	010 4215	2	4	428
	15	40	S403M-K40NP	2CCS573103R8557	010 4222	2	4	428
15	50	S403M-K50NP	2CCS573103R8577	010 4239	2	4	428	
15	63	S403M-K63NP	2CCS573103R8597	010 4246	2	4	428	



Ordering details for auxiliary switch and signal contacts on page 56–57

The neutral is protected with 100% of the nominal value of the pole conductor

## Miniature circuit breaker (MCB)

S400M-UC, Universal current range,  $I_{cu} = 10 \dots 25 \text{ kA}$

C according to IEC/EN 60947-2

	$I_n$ [A]	Type name	ABB IT number	EAN number 761 227	Pack- aging unit	Module	Weight in grams
 <p>1 P 220V= 1 +2</p>	0.5	S401M-UCC0.5	2CCS561001R1984	010 9746	10	1	145
	1	S401M-UCC1	2CCS561001R1014	010 9753	10	1	145
	1.6	S401M-UCC1.6	2CCS561001R1974	010 9760	10	1	145
	2	S401M-UCC2	2CCS561001R1024	010 9777	10	1	145
	3	S401M-UCC3	2CCS571001R1034	010 9784	10	1	145
	4	S401M-UCC4	2CCS571001R1044	010 9791	10	1	145
	6	S401M-UCC6	2CCS571001R1064	010 9807	10	1	145
	8	S401M-UCC8	2CCS571001R1084	010 9814	10	1	145
	10	S401M-UCC10	2CCS571001R1104	010 9821	10	1	145
	13	S401M-UCC13	2CCS571001R1134	010 9838	10	1	145
	16	S401M-UCC16	2CCS571001R1164	010 9845	10	1	145
	20	S401M-UCC20	2CCS571001R1204	010 9852	10	1	145
	25	S401M-UCC25	2CCS571001R1254	010 9869	10	1	145
	32	S401M-UCC32	2CCS571001R1324	010 9876	10	1	145
 <p>2 P 440V= 1 3 +2 4-</p>	0.5	S402M-UCC0.5	2CCS562001R1984	010 9913	5	2	290
	1	S402M-UCC1	2CCS562001R1014	010 9920	5	2	290
	1.6	S402M-UCC1.6	2CCS562001R1974	010 9937	5	2	290
	2	S402M-UCC2	2CCS562001R1024	010 9944	5	2	290
	3	S402M-UCC3	2CCS572001R1034	010 9951	5	2	290
	4	S402M-UCC4	2CCS572001R1044	010 9968	5	2	290
	6	S402M-UCC6	2CCS572001R1064	010 9975	5	2	290
	8	S402M-UCC8	2CCS572001R1084	010 9982	5	2	290
	10	S402M-UCC10	2CCS572001R1104	010 9999	5	2	290
	13	S402M-UCC13	2CCS572001R1134	011 0001	5	2	290
	16	S402M-UCC16	2CCS572001R1164	011 0018	5	2	290
	20	S402M-UCC20	2CCS572001R1204	011 0025	5	2	290
	25	S402M-UCC25	2CCS572001R1254	011 0032	5	2	290
	32	S402M-UCC32	2CCS572001R1324	011 0049	5	2	290
40	S402M-UCC40	2CCS572001R1404	011 0056	5	2	290	
50	S402M-UCC50	2CCS572001R1504	011 0063	5	2	290	
63	S402M-UCC63	2CCS572001R1634	011 0070	5	2	290	

Ordering details for auxiliary switch and signal contacts on page 56–57

**Connection diagram,  
single-pole (max. 220V=) S401M-UC**

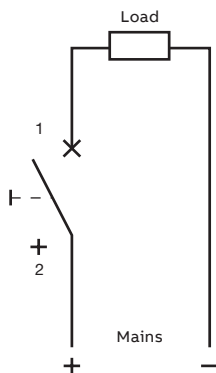



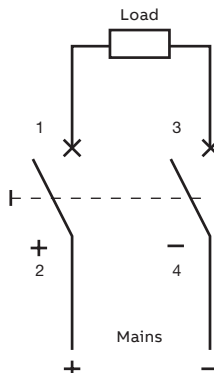

**Connection diagram,  
two-pole (max. 440V=) S402M-UC**



## Miniature circuit breaker (MCB)

S400M-UC, DC Universal current range,  $I_{cu} = 10 \dots 25 \text{ kA}$

Z according to IEC/EN 60947-2

	$I_n$ [A]	Type name	ABB IT number	EAN number 761 227	Pack- aging unit	Module	Weight in grams
 <p>1 P 220V=</p> 	0.5	S401M-UCZ0.5	2CCS561001R1988	011 0087	10	1	145
	1	S401M-UCZ1	2CCS561001R1018	011 0094	10	1	145
	1.6	S401M-UCZ1.6	2CCS561001R1978	011 0100	10	1	145
	2	S401M-UCZ2	2CCS561001R1028	011 0117	10	1	145
	3	S401M-UCZ3	2CCS571001R1038	011 0124	10	1	145
	4	S401M-UCZ4	2CCS571001R1048	011 0131	10	1	145
	6	S401M-UCZ6	2CCS571001R1068	011 0148	10	1	145
	8	S401M-UCZ8	2CCS571001R1088	011 0155	10	1	145
	10	S401M-UCZ10	2CCS571001R1108	011 0162	10	1	145
	13	S401M-UCZ13	2CCS571001R1138	011 0179	10	1	145
	16	S401M-UCZ16	2CCS571001R1168	011 0186	10	1	145
	20	S401M-UCZ20	2CCS571001R1208	011 0193	10	1	145
	25	S401M-UCZ25	2CCS571001R1258	011 0209	10	1	145
	32	S401M-UCZ32	2CCS571001R1328	011 0216	10	1	145
40	S401M-UCZ40	2CCS571001R1408	011 0223	10	1	145	
50	S401M-UCZ50	2CCS571001R1508	011 0230	10	1	145	
63	S401M-UCZ63	2CCS571001R1638	011 0247	10	1	145	
 <p>2 P 440V=</p> 	0.5	S402M-UCZ0.5	2CCS562001R1988	011 0254	5	2	290
	1	S402M-UCZ1	2CCS562001R1018	011 0261	5	2	290
	1.6	S402M-UCZ1.6	2CCS562001R1978	011 0278	5	2	290
	2	S402M-UCZ2	2CCS562001R1028	011 0285	5	2	290
	3	S402M-UCZ3	2CCS572001R1038	011 0292	5	2	290
	4	S402M-UCZ4	2CCS572001R1048	011 0308	5	2	290
	6	S402M-UCZ6	2CCS572001R1068	011 0315	5	2	290
	8	S402M-UCZ8	2CCS572001R1088	011 0322	5	2	290
	10	S402M-UCZ10	2CCS572001R1108	011 0339	5	2	290
	13	S402M-UCZ13	2CCS572001R1138	011 0346	5	2	290
	16	S402M-UCZ16	2CCS572001R1168	011 0353	5	2	290
	20	S402M-UCZ20	2CCS572001R1208	011 0360	5	2	290
	25	S402M-UCZ25	2CCS572001R1258	011 0377	5	2	290
	32	S402M-UCZ32	2CCS572001R1328	011 0384	5	2	290
40	S402M-UCZ40	2CCS572001R1408	011 0391	5	2	290	
50	S402M-UCZ50	2CCS572001R1508	011 0407	5	2	290	
63	S402M-UCZ63	2CCS572001R1638	011 0414	5	2	290	

Ordering details for auxiliary switch and signal contacts on page 56–57

Connection diagram,  
single-pole (max. 220V=) S401M-UC

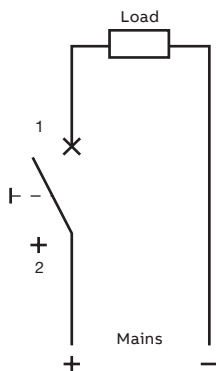

Connection diagram,  
two-pole (max. 440V=) S402M-UC

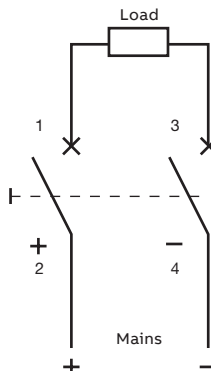

## Miniature circuit breaker (MCB) for IEC



### S400P technical features

<b>Standards</b>		
IEC/EN 60694-2		x
<b>General data</b>		
Tripping characteristics		B, C, K
Poles		1P, 1P+NP, 2P, 3P, 3P+NP
Rated current $I_n$		2, 3, 4, 6, 8, 10, 13, 16, 20, 25, 32, 40, 50, 63A
Calibration temperature		B, C 30°C; K 40°C
Rated frequency		50/60Hz
Rated insulation voltage $U_i$ AC 240/415V		440V
Rated insulation voltage $U_i$ AC 277/480 V		500V
Rated impulse withstand voltage $U_{imp}$		4 kV
Overvoltage category		III
Pollution degree	AC 240/415V: 3	AC 277/480V: 2
<b>Data acc. to IEC/EN 60947-2</b>		
Rated operational voltage $U_e$	1P, 1P+NP: AC 240V 2P, 3P, 3P+NP: AC 240/415V 1P 60 V DC; 2P 125 V DC ( $U_{max}$ )	1P, 1P+NP: AC 277 V 2P, 3P, 3P+NP: AC 277/480V
Minimum operating voltage		AC 12 V
Rated ultimate short-circuit capacity $I_{cu}$	40 kA (2 up to 16 A, 240/415 VAC) 30 kA (20 up to 40 A, 240/415 VAC) 20 kA (50 up to 63 A, 240/415 VAC)	20 kA (2 up to 16 A, 277/480 VAC) 15 kA (20 up to 40 A, 277/480 VAC) 5 kA (50 up to 63 A, 277/480 VAC)
Rated service short-circuit capacity $I_{cs}$	20 kA (2 up to 16 A, 240/415 VAC) 15 kA 20 up to 40 A, 240/415 VAC) 7.5 kA 50 up to 63 A, 240/415 VAC)	10 kA (2 up to 16 A, 277/480 VAC) 5 kA (20 up to 40 A, 277/480 VAC) 2.5 kA (50 up to 63 A, 277/480 VAC)
Reference ambient air temperature for overload tripping		B, C: 30°C, K: 40°C
<b>Mechanical Data</b>		
Contact position indication (green OFF/red ON)		x
L1/L2/L3 position indication		x
N position indication		x
Label holder		x
IP Code		IP20B, IP40 in enclosure with cover
Endurance		Electrical endurance: 10000 ops Mechanical endurance: 10000 ops
Shock resistance acc. to IEC/EN 61373		5 g / 30 ms, 3 shocks
Vibration resistance acc. to IEC/EN 60068-2-6		2...13.2 Hz/1 mm 13.2...100 Hz/0.7 g, 5 cycles 5...150...5 Hz/1 g, 4 sweeps
Environmental conditions (damp heat) acc. to IEC/EN 60068-2-30		28 cycles with 55°C/90...96% and 25°C/95...100%
Ambient temperature		-25...+55°C
Storage temperature		-40...+70°C
<b>Installation</b>		
Top terminal type		Failsafe bi-directional cylinder-lift terminal with double slot 35/10 mm <sup>2</sup>
Top terminal rigid IEC connections (solid/stranded)		Single: 0.75 ... 35 mm <sup>2</sup> (front slot), 0.75 ... 6 mm <sup>2</sup> (rear slot) Multiple: 2x 0.75 ... 10 mm <sup>2</sup> (front slot), 2x 0.75 ... 6 mm <sup>2</sup> (rear slot), with cables of same type and size
Top terminal flexible IEC connections		Single: 0.75 ... 25 mm <sup>2</sup> (front side), 0.75 ... 6 mm <sup>2</sup> (rear slot) Multiple: 2x 0.75 ... 10 mm <sup>2</sup> (front slot), 2x 0.75 ... 6 mm <sup>2</sup> (rear slot), with cables of same type and size
Top terminal screwdriver		No. 2 Pozidrive
Top terminal stripping length		12.5 mm
Top terminal tightening torque		2.8 Nm
Bottom terminal type		Movable plug-on terminal L1/L2/L3, fixed plug-on terminal N
Mounting		SMISLINE TP socket system only
Mounting position		Any
Supply		Any

## Miniature circuit breaker (MCB)

S400P-B,  $I_{cu} = 40 \dots 20 \text{ kA}$

B according to IEC/EN 60947-2



	$I_{cu}$ [kA]	$I_n$ [A]	Type name	ABB IT number	EAN number 761 227	Pack- aging unit	Module	Weight in grams
	40	2	S401P-B2	2CCG000364R0001	150 8418	10	1	115
	40	3	S401P-B3	2CCG000475R0001	150 8425	10	1	115
	40	4	S401P-B4	2CCG000497R0001	150 8432	10	1	115
	40	6	S401P-B6	2CCG000508R0001	150 8449	10	1	115
	40	8	S401P-B8	2CCG000519R0001	150 8456	10	1	115
	40	10	S401P-B10	2CCG000530R0001	150 8463	10	1	115
	40	13	S401P-B13	2CCG000541R0001	150 8470	10	1	115
	40	16	S401P-B16	2CCG000552R0001	150 8487	10	1	115
	30	20	S401P-B20	2CCG000563R0001	150 8494	10	1	115
	30	25	S401P-B25	2CCG000365R0001	150 8500	10	1	115
	30	32	S401P-B32	2CCG000376R0001	150 8517	10	1	115
	30	40	S401P-B40	2CCG000387R0001	150 8524	10	1	115
	20	50	S401P-B50	2CCG000398R0001	150 8531	10	1	115
20	63	S401P-B63	2CCG000409R0001	150 8548	10	1	115	
	40	2	S402P-B2	2CCG000496R0001	150 8692	5	2	230
	40	3	S402P-B3	2CCG000498R0001	150 8708	5	2	230
	40	4	S402P-B4	2CCG000499R0001	150 8715	5	2	230
	40	6	S402P-B6	2CCG000500R0001	150 8722	5	2	230
	40	8	S402P-B8	2CCG000501R0001	150 8739	5	2	230
	40	10	S402P-B10	2CCG000502R0001	150 8746	5	2	230
	40	13	S402P-B13	2CCG000503R0001	150 8753	5	2	230
	40	16	S402P-B16	2CCG000504R0001	150 8760	5	2	230
	30	20	S402P-B20	2CCG000505R0001	150 8777	5	2	230
	30	25	S402P-B25	2CCG000506R0001	150 8784	5	2	230
	30	32	S402P-B32	2CCG000507R0001	150 8791	5	2	230
	30	40	S402P-B40	2CCG000509R0001	150 8807	5	2	230
	20	50	S402P-B50	2CCG000510R0001	150 8814	5	2	230
20	63	S402P-B63	2CCG000511R0001	150 8821	5	2	230	
	40	2	S403P-B2	2CCG000512R0001	150 8838	4	3	345
	40	3	S403P-B3	2CCG000513R0001	150 8845	4	3	345
	40	4	S403P-B4	2CCG000514R0001	150 8852	4	3	345
	40	6	S403P-B6	2CCG000515R0001	150 8869	4	3	345
	40	8	S403P-B8	2CCG000516R0001	150 8876	4	3	345
	40	10	S403P-B10	2CCG000517R0001	150 8883	4	3	345
	40	13	S403P-B13	2CCG000518R0001	150 8890	4	3	345
	40	16	S403P-B16	2CCG000520R0001	150 8906	4	3	345
	30	20	S403P-B20	2CCG000521R0001	150 8913	4	3	345
	30	25	S403P-B25	2CCG000522R0001	150 8920	4	3	345
	30	32	S403P-B32	2CCG000523R0001	150 8937	4	3	345
	30	40	S403P-B40	2CCG000524R0001	150 8944	4	3	345
	20	50	S403P-B50	2CCG000525R0001	150 8951	4	3	345
20	63	S403P-B63	2CCG000526R0001	150 8968	4	3	345	

Ordering details for auxiliary switch and signal contacts on page 56–57

## Miniature circuit breaker (MCB)

S400P-C,  $I_{cu} = 40 \dots 20 \text{ kA}$

C according to IEC/EN 60947-2

	$I_{cu}$ [kA]	$I_n$ [A]	Type name	ABB IT number	EAN number 761 227	Pack- aging unit	Module	Weight in grams	
	40	2	S401P-C2	2CCG000543R0001	150 9118	10	1	115	
	40	3	S401P-C3	2CCG000544R0001	150 9125	10	1	115	
	40	4	S401P-C4	2CCG000545R0001	150 9132	10	1	115	
	40	6	S401P-C6	2CCG000546R0001	150 9149	10	1	115	
	40	8	S401P-C8	2CCG000547R0001	150 9156	10	1	115	
	40	10	S401P-C10	2CCG000548R0001	150 9163	10	1	115	
	40	13	S401P-C13	2CCG000549R0001	150 9170	10	1	115	
	40	16	S401P-C16	2CCG000550R0001	150 9187	10	1	115	
	30	20	S401P-C20	2CCG000551R0001	150 9194	10	1	115	
	30	25	S401P-C25	2CCG000553R0001	150 9200	10	1	115	
	30	32	S401P-C32	2CCG000554R0001	150 9217	10	1	115	
	30	40	S401P-C40	2CCG000555R0001	150 9224	10	1	115	
	20	50	S401P-C50	2CCG000556R0001	150 9231	10	1	115	
	20	63	S401P-C63	2CCG000557R0001	150 9248	10	1	115	
		40	2	S402P-C2	2CCG000573R0001	150 9392	5	2	230
		40	3	S402P-C3	2CCG000366R0001	150 9408	5	2	230
40		4	S402P-C4	2CCG000367R0001	150 9415	5	2	230	
40		6	S402P-C6	2CCG000368R0001	150 9422	5	2	230	
40		8	S402P-C8	2CCG000369R0001	150 9439	5	2	230	
40		10	S402P-C10	2CCG000370R0001	150 9446	5	2	230	
40		13	S402P-C13	2CCG000371R0001	150 9453	5	2	230	
40		16	S402P-C16	2CCG000372R0001	150 9460	5	2	230	
30		20	S402P-C20	2CCG000373R0001	150 9477	5	2	230	
30		25	S402P-C25	2CCG000374R0001	150 9484	5	2	230	
30		32	S402P-C32	2CCG000375R0001	150 9491	5	2	230	
30		40	S402P-C40	2CCG000377R0001	150 9507	5	2	230	
20		50	S402P-C50	2CCG000378R0001	150 9514	5	2	230	
20		63	S402P-C63	2CCG000379R0001	150 9521	5	2	230	
		40	2	S403P-C2	2CCG000380R0001	150 9538	4	3	345
		40	3	S403P-C3	2CCG000381R0001	150 9545	4	3	345
	40	4	S403P-C4	2CCG000382R0001	150 9552	4	3	345	
	40	6	S403P-C6	2CCG000383R0001	150 9569	4	3	345	
	40	8	S403P-C8	2CCG000384R0001	150 9576	4	3	345	
	40	10	S403P-C10	2CCG000385R0001	150 9583	4	3	345	
	40	13	S403P-C13	2CCG000386R0001	150 9590	4	3	345	
	40	16	S403P-C16	2CCG000388R0001	150 9606	4	3	345	
	30	20	S403P-C20	2CCG000389R0001	150 9613	4	3	345	
	30	25	S403P-C25	2CCG000390R0001	150 9620	4	3	345	
	30	32	S403P-C32	2CCG000391R0001	150 9637	4	3	345	
	30	40	S403P-C40	2CCG000392R0001	150 9644	4	3	345	
	20	50	S403P-C50	2CCG000393R0001	150 9651	4	3	345	
	20	63	S403P-C63	2CCG000394R0001	150 9668	4	3	345	



Ordering details for auxiliary switch and signal contacts on page 56–57



## Miniature circuit breaker (MCB)

S400P-K,  $I_{cu} = 40 \dots 20 \text{ kA}$

K according to IEC/EN 60947-2



	$I_{cu}$ [kA]	$I_n$ [A]	Type name	ABB IT number	EAN number 761 227	Pack- aging unit	Module	Weight in grams	
	40	2	S401P-K2	2CCG000411R0001	150 9811	10	1	115	
	40	3	S401P-K3	2CCG000412R0001	150 9828	10	1	115	
	40	4	S401P-K4	2CCG000413R0001	150 9835	10	1	115	
	40	6	S401P-K6	2CCG000414R0001	150 9842	10	1	115	
	40	8	S401P-K8	2CCG000415R0001	150 9859	10	1	115	
	40	10	S401P-K10	2CCG000416R0001	150 9866	10	1	115	
	40	13	S401P-K13	2CCG000417R0001	150 9873	10	1	115	
	40	16	S401P-K16	2CCG000418R0001	150 9880	10	1	115	
	30	20	S401P-K20	2CCG000419R0001	150 9897	10	1	115	
	30	25	S401P-K25	2CCG000421R0001	150 9903	10	1	115	
	30	32	S401P-K32	2CCG000422R0001	150 9910	10	1	115	
	30	40	S401P-K40	2CCG000423R0001	150 9927	10	1	115	
	20	50	S401P-K50	2CCG000424R0001	150 9934	10	1	115	
	20	63	S401P-K63	2CCG000425R0001	150 9941	10	1	115	
		40	2	S402P-K2	2CCG000441R0001	151 0091	5	2	230
		40	3	S402P-K3	2CCG000443R0001	151 0107	5	2	230
40		4	S402P-K4	2CCG000444R0001	151 0114	5	2	230	
40		6	S402P-K6	2CCG000445R0001	151 0121	5	2	230	
40		8	S402P-K8	2CCG000446R0001	151 0138	5	2	230	
40		10	S402P-K10	2CCG000447R0001	151 0145	5	2	230	
40		13	S402P-K13	2CCG000448R0001	151 0152	5	2	230	
40		16	S402P-K16	2CCG000449R0001	151 0169	5	2	230	
30		20	S402P-K20	2CCG000450R0001	151 0176	5	2	230	
30		25	S402P-K25	2CCG000451R0001	151 0183	5	2	230	
30		32	S402P-K32	2CCG000452R0001	151 0190	5	2	230	
30		40	S402P-K40	2CCG000454R0001	151 0206	5	2	230	
20		50	S402P-K50	2CCG000455R0001	151 0213	5	2	230	
20		63	S402P-K63	2CCG000456R0001	151 0220	5	2	230	
		40	2	S403P-K2	2CCG000457R0001	151 0237	4	3	345
		40	3	S403P-K3	2CCG000458R0001	151 0244	4	3	345
	40	4	S403P-K4	2CCG000459R0001	151 0251	4	3	345	
	40	6	S403P-K6	2CCG000460R0001	151 0268	4	3	345	
	40	8	S403P-K8	2CCG000461R0001	151 0275	4	3	345	
	40	10	S403P-K10	2CCG000462R0001	151 0282	4	3	345	
	40	13	S403P-K13	2CCG000463R0001	151 0299	4	3	345	
	40	16	S403P-K16	2CCG000465R0001	151 0305	4	3	345	
	30	20	S403P-K20	2CCG000466R0001	151 0312	4	3	345	
	30	25	S403P-K25	2CCG000467R0001	151 0329	4	3	345	
	30	32	S403P-K32	2CCG000468R0001	151 0336	4	3	345	
	30	40	S403P-K40	2CCG000469R0001	151 0343	4	3	345	
	20	50	S403P-K50	2CCG000470R0001	151 0350	4	3	345	
	20	63	S403P-K63	2CCG000471R0001	151 0367	4	3	345	

Ordering details for auxiliary switch and signal contacts on page 56–57

## Miniature circuit breaker (MCB)

S400P-B with protected neutral  $I_{cu} = 20 \dots 40 \text{ kA}$

K according to IEC/EN 60947-2





	$I_{cu}$ [kA]	$I_n$ [A]	Type name	ABB IT number	EAN number 761 227	Pack- aging unit	Module	Weight in grams
	40	2	S401P-B2NP	2CCG000420R0001	150 8555	5	2	230
	40	3	S401P-B3NP	2CCG000431R0001	150 8562	5	2	230
	40	4	S401P-B4NP	2CCG000442R0001	150 8579	5	2	230
	40	6	S401P-B6NP	2CCG000453R0001	150 8586	5	2	230
	40	8	S401P-B8NP	2CCG000464R0001	150 8593	5	2	230
	40	10	S401P-B10NP	2CCG000476R0001	150 8609	5	2	230
	40	13	S401P-B13NP	2CCG000487R0001	150 8616	5	2	230
	40	16	S401P-B16NP	2CCG000489R0001	150 8623	5	2	230
	30	20	S401P-B20NP	2CCG000490R0001	150 8630	5	2	230
	30	25	S401P-B25NP	2CCG000491R0001	150 8647	5	2	230
	30	32	S401P-B32NP	2CCG000492R0001	150 8654	5	2	230
	30	40	S401P-B40NP	2CCG000493R0001	150 8661	5	2	230
	20	50	S401P-B50NP	2CCG000494R0001	150 8678	5	2	230
20	63	S401P-B63NP	2CCG000495R0001	150 8685	5	2	230	
	40	2	S403P-B2NP	2CCG000527R0001	150 8975	2	4	460
	40	3	S403P-B3NP	2CCG000528R0001	150 8982	2	4	460
	40	4	S403P-B4NP	2CCG000529R0001	150 8999	2	4	460
	40	6	S403P-B6NP	2CCG000531R0001	150 9002	2	4	460
	40	8	S403P-B8NP	2CCG000532R0001	150 9019	2	4	460
	40	10	S403P-B10NP	2CCG000533R0001	150 9026	2	4	460
	40	13	S403P-B13NP	2CCG000534R0001	150 9033	2	4	460
	40	16	S403P-B16NP	2CCG000535R0001	150 9040	2	4	460
	30	20	S403P-B20NP	2CCG000536R0001	150 9057	2	4	460
	30	25	S403P-B25NP	2CCG000537R0001	150 9064	2	4	460
	30	32	S403P-B32NP	2CCG000538R0001	150 9071	2	4	460
	30	40	S403P-B40NP	2CCG000539R0001	150 9088	2	4	460
	20	50	S403P-B50NP	2CCG000540R0001	150 9095	2	4	460
20	63	S403P-B63NP	2CCG000542R0001	150 9101	2	4	460	

Ordering details for auxiliary switch and signal contacts on page 56–57

## Miniature circuit breaker (MCB)

S400P-C with protected neutral  $I_{cu} = 20 \dots 40 \text{ kA}$

C according to IEC/EN 60947-2





	$I_{cu}$ [kA]	$I_n$ [A]	Type name	ABB IT number	EAN number 761 227	Pack- aging unit	Module	Weight in grams
 	40	2	S401P-C2NP	2CCG000558R0001	150 9255	5	2	230
	40	3	S401P-C3NP	2CCG000559R0001	150 9262	5	2	230
	40	4	S401P-C4NP	2CCG000560R0001	150 9279	5	2	230
	40	6	S401P-C6NP	2CCG000561R0001	150 9286	5	2	230
	40	8	S401P-C8NP	2CCG000562R0001	150 9293	5	2	230
	40	10	S401P-C10NP	2CCG000564R0001	150 9309	5	2	230
	40	13	S401P-C13NP	2CCG000565R0001	150 9316	5	2	230
	40	16	S401P-C16NP	2CCG000566R0001	150 9323	5	2	230
	30	20	S401P-C20NP	2CCG000567R0001	150 9330	5	2	230
	30	25	S401P-C25NP	2CCG000568R0001	150 9347	5	2	230
	30	32	S401P-C32NP	2CCG000569R0001	150 9354	5	2	230
	30	40	S401P-C40NP	2CCG000570R0001	150 9361	5	2	230
	20	50	S401P-C50NP	2CCG000571R0001	150 9378	5	2	230
	20	63	S401P-C63NP	2CCG000572R0001	150 9385	5	2	230
 	40	2	S403P-C2NP	2CCG000395R0001	150 9675	2	4	460
	40	3	S403P-C3NP	2CCG000396R0001	150 9682	2	4	460
	40	4	S403P-C4NP	2CCG000397R0001	150 9699	2	4	460
	40	6	S403P-C6NP	2CCG000399R0001	150 9705	2	4	460
	40	8	S403P-C8NP	2CCG000400R0001	150 9712	2	4	460
	40	10	S403P-C10NP	2CCG000401R0001	150 9729	2	4	460
	40	13	S403P-C13NP	2CCG000402R0001	150 9736	2	4	460
	40	16	S403P-C16NP	2CCG000403R0001	150 9743	2	4	460
	30	20	S403P-C20NP	2CCG000404R0001	150 9750	2	4	460
	30	25	S403P-C25NP	2CCG000405R0001	150 9767	2	4	460
	30	32	S403P-C32NP	2CCG000406R0001	150 9774	2	4	460
	30	40	S403P-C40NP	2CCG000407R0001	150 9781	2	4	460
	20	50	S403P-C50NP	2CCG000408R0001	150 9798	2	4	460
	20	63	S403P-C63NP	2CCG000410R0001	150 9804	2	4	460

Ordering details for auxiliary switch and signal contacts on page 56–57

## Miniature circuit breaker (MCB)

S400P-K with protected neutral  $I_{cu} = 20 \dots 40 \text{ kA}$

K according to IEC/EN 60947-2

	$I_{cu}$ [kA]	$I_n$ [A]	Type name	ABB IT number	EAN number 761 227	Pack- aging unit	Module	Weight in grams
 	40	2	S401P-K2NP	2CCG000426R0001	150 9958	5	2	230
	40	3	S401P-K3NP	2CCG000427R0001	150 9965	5	2	230
	40	4	S401P-K4NP	2CCG000428R0001	150 9972	5	2	230
	40	6	S401P-K6NP	2CCG000429R0001	150 9989	5	2	230
	40	8	S401P-K8NP	2CCG000430R0001	150 9996	5	2	230
	40	10	S401P-K10NP	2CCG000432R0001	151 0008	5	2	230
	40	13	S401P-K13NP	2CCG000433R0001	151 0015	5	2	230
	40	16	S401P-K16NP	2CCG000434R0001	151 0022	5	2	230
	30	20	S401P-K20NP	2CCG000435R0001	151 0039	5	2	230
	30	25	S401P-K25NP	2CCG000436R0001	151 0046	5	2	230
	30	32	S401P-K32NP	2CCG000437R0001	151 0053	5	2	230
	30	40	S401P-K40NP	2CCG000438R0001	151 0060	5	2	230
	20	50	S401P-K50NP	2CCG000439R0001	151 0077	5	2	230
20	63	S401P-K63NP	2CCG000440R0001	151 0084	5	2	230	
 	40	2	S403P-K2NP	2CCG000472R0001	151 0374	2	4	460
	40	3	S403P-K3NP	2CCG000473R0001	151 0381	2	4	460
	40	4	S403P-K4NP	2CCG000474R0001	151 0398	2	4	460
	40	6	S403P-K6NP	2CCG000477R0001	151 0404	2	4	460
	40	8	S403P-K8NP	2CCG000478R0001	151 0411	2	4	460
	40	10	S403P-K10NP	2CCG000479R0001	151 0428	2	4	460
	40	13	S403P-K13NP	2CCG000480R0001	151 0435	2	4	460
	40	16	S403P-K16NP	2CCG000481R0001	151 0442	2	4	460
	30	20	S403P-K20NP	2CCG000482R0001	151 0459	2	4	460
	30	25	S403P-K25NP	2CCG000483R0001	151 0466	2	4	460
	30	32	S403P-K32NP	2CCG000484R0001	151 0473	2	4	460
	30	40	S403P-K40NP	2CCG000485R0001	151 0480	2	4	460
	20	50	S403P-K50NP	2CCG000486R0001	151 0497	2	4	460
20	63	S403P-K63NP	2CCG000488R0001	151 0503	2	4	460	

Ordering details for auxiliary switch and signal contacts on page 56–57

## Miniature circuit breaker (MCB) for UL489 277/480 VAC

### SUP400M technical features

#### Technical Data

##### General Data

Standards	UL 489, CSA 22.2 No. 5, IEC/EN 60947-2
Rated voltage	277/480VAC
Poles	1P, 2P, 3P
Tripping characteristics	K
Rated current $I_n$	2 to 35 A
Rated frequency $f$	50/60Hz
Short circuit current rating (acc. to UL 489)	10kA
Overvoltage category	III
Pollution degree	3
Reference temperature for tripping characteristics	40°C

##### Mechanical Data

Contact position indication	Real CPI (green OFF / red ON)
L1/L2/L3 position indication	Yes
IP Code	IP20B, IP40 in enclosure with cover
Label holder	Yes
Endurance	Electrical endurance: 10000 ops Mechanical endurance: 10000 ops
Shock resistance acc. to IEC/EN 61373	5 g/30ms, 3 shocks
Vibration resistance acc. to IEC/EN 60068-2-6	2 ... 13.2 Hz/1 mm 13.2 ... 100 Hz/0.7 g, 5 cycles 5 ... 150 ... 5 Hz/1 g, 4 sweeps
Environmental conditions (damp heat) acc. to IEC/EN 60068-2-30	28 cycles with 55°C/90 ... 96% and 25°C/95 ... 100%
Ambient temperature	-25 ... +60°C
Storage temperature	-40 ... +70°C

##### Installation

Terminal at load side	Failsafe bi-directional cylinder-lift terminal with double slot 35/10mm <sup>2</sup>
Top terminal rigid IEC connections (solid/stranded)	- Single: 0.75 ... 35 mm <sup>2</sup> (front slot), 0.75 ... 10mm <sup>2</sup> (rear slot) - Multiple: -
Top terminal flexible IEC connections	- Single: 0.75 ... 25 mm <sup>2</sup> (front side), 0.75 ... 6 mm <sup>2</sup> (rear slot) - Multiple: -
Top terminal UL connections	- Single: AWG 14...8, Cu only - Multiple: -
Torque	2.8Nm, 25 in. lbs.
Stripping length	12.5mm
Wire temperature	60/75°C
Screwdriver	No. 2 Pozidrive
Terminal at line side	Movable plug-on terminal L1, L2, L3
Mounting	SMISSLINE TP socket system only
Mounting position	Any

##### Dimensions and weight





Pole weight	120g
-------------	------

The devices are suitable with  
 - S2C-H6RU (auxiliary contact)  
 - S2C-S6RU (signal/auxiliary contact)  
 - E210-DH (false pole 1/2 module)  
 - SA (locking device)

## Miniature circuit breaker SUP400 (MCB)

SUP400 for branch circuit protection acc. to UL 489 File E312425

### Ordering Data

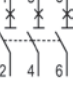
	$I_n$ [A]	Type	ABB IT number	EAN number 761 227	Packaging unit	Module	Weight in grams
 	2	SUP401M-K2	2CCG000142R0001	1506759	10	1	120
	3	SUP401M-K3	2CCG000143R0001	1506766	10	1	120
	4	SUP401M-K4	2CCG000144R0001	1506773	10	1	120
	5	SUP401M-K5	2CCG000153R0001	1506865	10	1	120
	6	SUP401M-K6	2CCG000145R0001	1506780	10	1	120
	8	SUP401M-K8	2CCG000146R0001	1506797	10	1	120
	10	SUP401M-K10	2CCG000147R0001	1506803	10	1	120
	13	SUP401M-K13	2CCG000148R0001	1506810	10	1	120
	15	SUP401M-K15	2CCG000154R0001	1506872	10	1	120
	16	SUP401M-K16	2CCG000149R0001	1506827	10	1	120
	20	SUP401M-K20	2CCG000150R0001	1506834	10	1	120
	25	SUP401M-K25	2CCG000151R0001	1506841	10	1	120
	30	SUP401M-K30	2CCG000152R0001	1506858	10	1	120
35	SUP401M-K35	2CCG000141R0001	1516109	10	1	120	
 	2	SUP402M-K2	2CCG000106R0001	1506384	5	2	240
	3	SUP402M-K3	2CCG000107R0001	1506391	5	2	240
	4	SUP402M-K4	2CCG000108R0001	1506506	5	2	240
	5	SUP402M-K5	2CCG000117R0001	1506599	5	2	240
	6	SUP402M-K6	2CCG000109R0001	1506513	5	2	240
	8	SUP402M-K8	2CCG000110R0001	1506520	5	2	240
	10	SUP402M-K10	2CCG000111R0001	1506537	5	2	240
	13	SUP402M-K13	2CCG000112R0001	1506544	5	2	240
	15	SUP402M-K15	2CCG000118R0001	1506605	5	2	240
	16	SUP402M-K16	2CCG000113R0001	1506551	5	2	240
	20	SUP402M-K20	2CCG000114R0001	1506568	5	2	240
	25	SUP402M-K25	2CCG000115R0001	1506575	5	2	240
	30	SUP402M-K30	2CCG000116R0001	1506582	5	2	240
35	SUP402M-K35	2CCG0001142R0001	1516116	5	2	240	
 	2	SUP403M-K2	2CCG000119R0001	1506612	3	3	360
	3	SUP403M-K3	2CCG000120R0001	1506629	3	3	360
	4	SUP403M-K4	2CCG000121R0001	1506636	3	3	360
	5	SUP403M-K5	2CCG000130R0001	1506728	3	3	360
	6	SUP403M-K6	2CCG000122R0001	1506643	3	3	360
	8	SUP403M-K8	2CCG000123R0001	1506650	3	3	360
	10	SUP403M-K10	2CCG000124R0001	1506667	3	3	360
	13	SUP403M-K13	2CCG000125R0001	1506674	3	3	360
	15	SUP403M-K15	2CCG000131R0001	1506735	3	3	360
	16	SUP403M-K16	2CCG000126R0001	1506681	3	3	360
	20	SUP403M-K20	2CCG000127R0001	1506698	3	3	360
	25	SUP403M-K25	2CCG000128R0001	1506704	3	3	360
	30	SUP403M-K30	2CCG000129R0001	1506711	3	3	360
35	SUP403M-K35	2CCG0001143R0001	1516123	3	3	360	

Ordering details for auxiliary switch and signal contacts on page 56–57

## Residual current operated circuit breaker (RCBO)

### The difference lies in the detail

Type F RCBOs have a minimum non-tripping time of 10 ms and a surge current withstand capacity (resistance against accidental tripping) of 3 kA. The standard functionality is not impaired by overlapping smooth DC residual currents of up to 10 mA. When using Type F RCBOs with short-time delay, there is no risk of false tripping due to (capacitive) currents flowing to ground for short periods.

Reliable recognition of the switching status through the new red/green position indicating device that shows the position of the inner contacts.

Short-circuit breaking capacity of 10 kA to 32A according to EN/IEC 61009-1  
 Rated breaking capacity  $I_{cu}$  kA  
 6...16A and 15kA 20...32A acc. to IEC/EN 60947-2

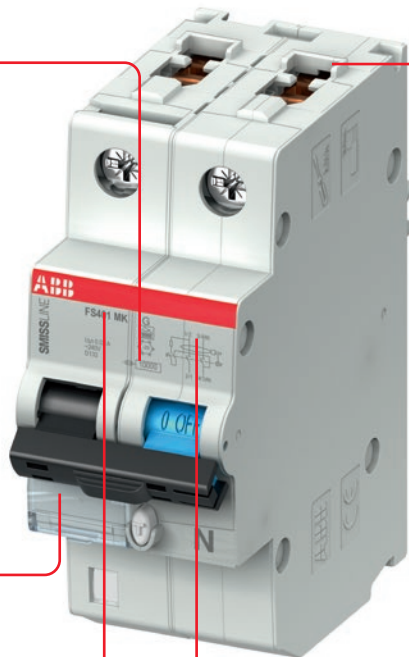

New, patented bidirectional terminal with captive screws for maximum comfort, safety and flexibility. The connection takes place in two chambers (35 mm<sup>2</sup> and 10 mm<sup>2</sup>). Two conductors with the same cross-section can be connected in each chamber.

Laser printing for clearly legible information during the entire service life.

## Residual current operated circuit breaker (RCBO)

### FS401 technical features

	FS401E	FS401M	FS401MK
Standards	IEC/EN 61009-1, IEC/EN 61009-2-1	IEC/EN 61009-1, IEC/EN 61009-2-1	IEC/EN 61009-1, IEC/EN 61009-2-1 IEC/EN 62423
<b>Electrical features</b>			
type (wave form of the earth leakage sensed)	A	A	APR - F
Number of poles	1P + N	1P + N	1P + N
Rated current $I_n$	$6 \leq I_n \leq 32A$	$6 \leq I_n \leq 32A$	$6 \leq I_n \leq 32A$
Rated sensitivity $I_{\Delta n}$	0.03A	0.03–0.1 A	0.03–0.3A
Rated voltage $U_e$	240V	240V	240V
Insulation voltage $U_i$	500V	500V	500V
Overvoltage category	III	III	III
Pollution degree	2	2	2
Operating voltage of circuit test	110V (170 for 30mA) – 264V	110V (170 for 30mA) – 264V	110V (170 for 30mA) – 264V
Rated frequency	50/60Hz	50/60Hz	50/60Hz
Rated breaking capacity acc. to IEC/EN 61009-1 $I_{cn}$	6000A	10000A	10000A
Rated ultimate short-circuit capacity $I_{cu}$ acc. to IEC/EN 60947-2 (only referring to short circuit test)	6...16 A 20...32A	25 kA 15 kA	25 kA 15 kA
Rated service short-circuit capacity $I_{cs}$ acc. to IEC/EN 60947-2 (only referring to short circuit test)	6...16 A 20...32A	15 kA 7.5 kA	15 kA 7.5 kA
Rated residual breaking capacity acc. to IEC/EN 61009-1 $I_{\Delta m}$	6000A	10000A	10000A
Rated impulse withstand voltage (1.2/50) $U_{imp}$	4 kV	4 kV	4 kV
Dielectric test voltage at ind. freq. for 1 min.	2.5 kV (50/60Hz, 1 min.)	2.5 kV (50/60Hz, 1 min.)	2.5 kV (50/60Hz, 1 min.)
Thermomagnetic release – characteristic	B: $3 I_n \leq I_n \leq 5 I_n$ C: $5 I_n \leq I_n \leq 10 I_n$	X X	X X
Energy limiting class acc. to EN 61009-1	3	3	3
<b>Mechanical features</b>			
Housing	Insulation group I, light grey RAL 7035	Insulation group I, light grey RAL 7035	Insulation group I, light grey RAL 7035
Toggle	Insulation group II, black RAL 9005, sealable in ON-OFF positions	Insulation group II, black RAL 9005, sealable in ON-OFF positions	Insulation group II, black RAL 9005, sealable in ON-OFF positions
Contact position indication	Green/Red Window	Green/Red Window	Green/Red Window
Endurance	Electrical endurance: 10000 ops Mechanical endurance: 10000 ops		
IP code	IP20, IP40 in enclosure with cover	IP20, IP40 in enclosure with cover	IP20, IP40 in enclosure with cover
Shock resistance acc. to IEC/EN 61373	5g–30ms, 3 shocks	5g–30ms, 3 shocks	5g–30ms, 3 shocks
Vibration resistance acc. to IEC/EN 60068-2-6	2...13.2 Hz/1 mm 13.2...100 Hz/0.7 g, 5 cycles 5...150 ... 5 Hz/1 g, 4 waves	2...13.2 Hz/1 mm 13.2...100 Hz/0.7 g, 5 cycles 5...150 ... 5 Hz/1 g, 4 waves	2...13.2 Hz/1 mm 13.2...100 Hz/0.7 g, 5 cycles 5...150 ... 5 Hz/1 g, 4 waves
Reference temperature for setting of thermal element	30 °C	30 °C	30 °C
Ambient temperature	–25...+60 °C	–25...+60 °C	–25...+60 °C
Storage temperature	–40...+70 °C	–40...+70 °C	–40...+70 °C
<b>Installation</b>			
Terminal type	failsafe bi-directional cylinder-lift terminal (shock protected)		
Top terminal rigid IEC connections (solid/stranded)	Single: 0.75 ... 35 mm <sup>2</sup> (front slot), 0.75 ... 10 mm <sup>2</sup> (rear slot) Multiple: 2x0.75 ... 10 mm <sup>2</sup> (front slot), 2x0.75 ... 6 mm <sup>2</sup> (rear slot), with cables of same type and size		
Top terminal flexible IEC connections	Single: 0.75 ... 25 mm <sup>2</sup> (front side), 0.75 ... 6 mm <sup>2</sup> (rear slot) Multiple: 2x0.75 ... 10 mm <sup>2</sup> (front slot), 2x0.75 ... 6 mm <sup>2</sup> (rear slot), with cables of same type and size		



## RCBOs (1P+N)



FS401 series   A  type,  
B and C characteristics

### A Type:



Function: protection of end user single-phase circuits against overload and short-circuit

currents; protection against the effects of sinusoidal alternating and direct pulsating earth fault currents.



### B, 6 kA according to EN 61009-1

	$I_{\Delta n}$ [mA]	$I_n$ [A]	$I_{cn}$ [kA]	Type name	ABB IT number	EAN number 761 227	Pack- aging unit	Module	Weight in grams
	30	10	6	FS401E-B10/0.03	2CCL562111E1105	147 2825	1	2	200
	30	13	6	FS401E-B13/0.03	2CCL562111E0135	010 8558	1	2	200
	30	16	6	FS401E-B16/0.03	2CCL562111E0165	010 8565	1	2	200
	30	20	6	FS401E-B20/0.03	2CCL562111E0205	010 9692	1	2	200
	30	25	6	FS401E-B25/0.03	2CCL562111E0255	010 9708	1	2	200
	30	32	6	FS401E-B32/0.03	2CCL562111E0325	010 9715	1	2	200
									



### C, 6 kA according to EN 61009-1

	30	6	6	FS401E-C6/0.03	2CCL562111E1064	147 2788	1	2	200
	30	10	6	FS401E-C10/0.03	2CCL562111E1104	147 2801	1	2	200
	30	13	6	FS401E-C13/0.03	2CCL562111E0134	010 8572	1	2	200
	30	16	6	FS401E-C16/0.03	2CCL562111E0164	010 8589	1	2	200
	30	20	6	FS401E-C20/0.03	2CCL562110E0204	010 4574	1	2	200
	30	25	6	FS401E-C25/0.03	2CCL562110E0254	010 4581	1	2	200
	30	32	6	FS401E-C32/0.03	2CCL562110E0324	010 4598	1	2	200
									



### B, 10 kA according to EN 61009-1

	30	6	10	FS401M-B6/0.03	2CCL562110E1065	147 2641	1	2	200
	30	10	10	FS401M-B10/0.03	2CCL562110E0105	010 9685	1	2	200
	30	13	10	FS401M-B13/0.03	2CCL562110E0135	010 4505	1	2	200
	30	16	10	FS401M-B16/0.03	2CCL562110E0165	010 4512	1	2	200
	30	20	10	FS401M-B20/0.03	2CCL562110E1205	147 2689	1	2	200
	30	25	10	FS401M-B25/0.03	2CCL562110E1255	147 2726	1	2	200
	30	32	10	FS401M-B32/0.03	2CCL562110E1325	147 2764	1	2	200
									

### C, 10 kA according to EN 61009-1

	30	6	10	FS401M-C6/0.03	2CCL562010E0064	140 6905	1	2	200
	30	10	10	FS401M-C10/0.03	2CCL562110E0104	010 4543	1	2	200
	30	13	10	FS401M-C13/0.03	2CCL562110E0134	010 4550	1	2	200
	30	16	10	FS401M-C16/0.03	2CCL562110E0164	010 4567	1	2	200
	30	20	10	FS401M-C20/0.03	2CCL562110E1204	147 2665	1	2	200
	30	25	10	FS401M-C25/0.03	2CCL562110E1254	147 2702	1	2	200
	30	32	10	FS401M-C32/0.03	2CCL562110E1324	147 2740	1	2	200
									

### C, 10 kA according to EN 61009-1

	100	6	10	FS401M-C6/0.1	2CCL562120E0064	142 4534	1	2	200
	100	10	10	FS401M-C10/0.1	2CCL562120E0104	141 3217	1	2	200
	100	13	10	FS401M-C13/0.1	2CCL562120E0134	149 0706	1	2	200
	100	16	10	FS401M-C16/0.1	2CCL562120E0164	142 1618	1	2	200
	100	20	10	FS401M-C20/0.1	2CCL562122E0204	149 0720	1	2	200
	100	25	10	FS401M-C25/0.1	2CCL562122E0254	149 0744	1	2	200
	100	32	10	FS401M-C32/0.1	2CCL562122E0324	149 0768	1	2	200
									

Ordering details for auxiliary switch and signal contacts on page 56–57

## RCBOs (1P+N)

FS401 series 10000 F   type, AP-R (high immunity)



B and C characteristics

### Type F:



Function: protection of end user single-phase circuits against overload and short-circuit currents; protection against the effects of sinusoidal alter-

nating earth fault currents; protection against indirect contact and additional protection against direct contact ( $I_{\Delta n}=30\text{ mA}$ ). Specifically suitable for the protection of lines supplying single phase inverters.



### B, 10kA according to EN 61009-1

	$I_{\Delta n}$ [mA]	$I_n$ [A]	$I_{cn}$ [kA]	Type name	ABB IT number	EAN number 761 227	Pack- aging unit	Module	Weight in grams
	30	6	10	FS401MK-B6/0.03	2CCL562130E1035	147 2849	1	2	200
	30	10	10	FS401MK-B10/0.03	2CCL562310E1105	147 2887	1	2	200
	30	13	10	FS401MK-B13/0.03	2CCL562310E1135	147 2900	1	2	200
	30	16	10	FS401MK-B16/0.03	2CCL562310E1165	147 2924	1	2	200
	30	20	10	FS401MK-B20/0.03	2CCL562310E1205	147 2962	1	2	200
	30	25	10	FS401MK-B25/0.03	2CCL562310E1255	147 3006	1	2	200
	30	32	10	FS401MK-B32/0.03	2CCL562310E1325	147 3044	1	2	200
									

### C 10kA according to EN 61009-1

	30	6	10	FS401MK-C6/0.03	2CCL562330E1064	147 3068	1	2	200
	30	10	10	FS401MK-C10/0.03	2CCL562310E0104	140 4031	1	2	200
	30	13	10	FS401MK-C13/0.03	2CCL562310E0134	010 4604	1	2	200
	30	16	10	FS401MK-C16/0.03	2CCL562310E0164	010 4611	1	2	200
	30	20	10	FS401MK-C20/0.03	2CCL562310E1204	147 2948	1	2	200
	30	25	10	FS401MK-C25/0.03	2CCL562310E1254	147 2986	1	2	200
	30	32	10	FS401MK-C32/0.03	2CCL562310E1324	147 3020	1	2	200
									

### C, 10kA according to EN 61009-1

	300	6	10	FS401MK-C6/0.3	2CCL562130E3034	147 3068	1	2	200
	300	10	10	FS401MK-C10/0.3	2CCL562330E1104	147 3082	1	2	200
	300	13	10	FS401MK-C13/0.3	2CCL562330E1134	147 3105	1	2	200
	300	16	10	FS401MK-C16/0.3	2CCL562330E1164	147 3143	1	2	200
	300	20	10	FS401MK-C20/0.3	2CCL562330E1204	147 3181	1	2	200
	300	25	10	FS401MK-C25/0.3	2CCL562330E1254	147 3228	1	2	200
	300	32	10	FS401MK-C32/0.3	2CCL562330E1324	147 3266	1	2	200
									

Ordering details for auxiliary switch and signal contacts on page 56–57

## Residual current operated circuit breaker (RCBO)

The difference lies in the detail

Type F RCBOs have a minimum non-tripping time of 10 ms and a surge current withstand capacity (resistance against accidental tripping) of 3 kA. The standard functionality is not impaired by overlapping smooth DC residual currents of up to 10 mA. When using Type F RCBOs with short-time delay, there is no risk of false tripping due to (capacitive) currents flowing to ground for short periods.

Reliable recognition of the switching status through the new red/green position indicating device that shows the position of the inner contacts.

Short-circuit breaking capacity of 10 kA to 32A according to EN/IEC 61009-1  
 Rated breaking capacity  $I_{cu}$  kA  
 6...16A and 15kA 20...32A  
 acc. to IEC/EN 60947-2

New, patented bidirectional terminal with captive screws for maximum comfort, safety and flexibility. The connection takes place in two chambers (35 mm<sup>2</sup> and 10 mm<sup>2</sup>). Two conductors with the same cross-section can be connected in each chamber.

Laser printing for clearly legible information during the entire service life.

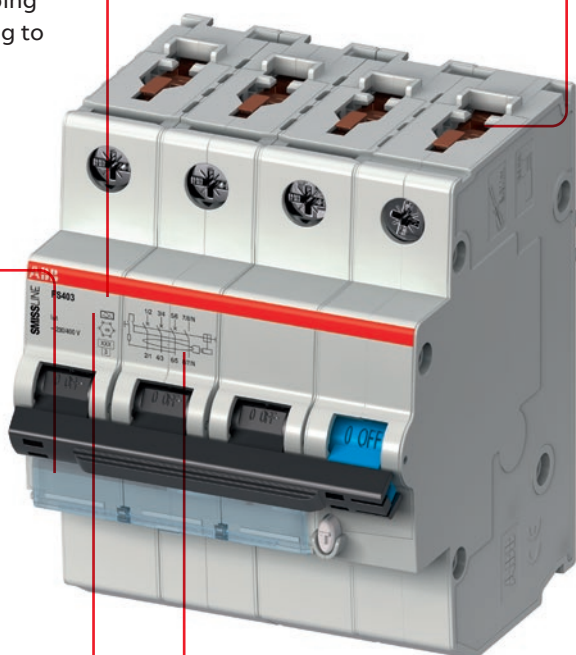

## Residual current operated circuit breaker (RCBO)

### FS403 technical features

	FS403E	FS403M	FS403MK
Standards	IEC 61009-1, EN 61009-1, EN 61009-2-1	IEC 61009-1, EN 61009-1, EN 61009-2-1	IEC/EN 61009-1, IEC/EN 61009-2-1, IEC/EN 62423
<b>Electrical features</b>			
type (wave form of the earth leakage sensed)	A	A	APR - F
Number of poles	3P + N	3P + N	3P + N
Rated current $I_n$	$6 \leq I_n \leq 32\text{ A}$	$6 \leq I_n \leq 32\text{ A}$	$6 \leq I_n \leq 32\text{ A}$
Rated sensitivity $I_{\Delta n}$	0.03A	0.03–0.1A	0.03–0.3A
Rated voltage $U_e$	240/415V	240/415V	240/415V
Insulation voltage $U_i$	500V	500V	500V
Overvoltage category	III	III	III
Pollution degree	2	2	2
Operating voltage of circuit test	110V (170 for 30mA) – 264V	110V (170 for 30mA) – 264V	110V (170 for 30mA) – 264V
Rated frequency	50/60Hz	50/60Hz	50/60Hz
Rated breaking capacity acc. to IEC/EN 61009-1 $I_{cn}$	6000A	10000A	10000A
Rated ultimate short-circuit capacity $I_{cu}$ acc. to IEC/EN 60947-2 (only referring to short circuit test)	6...16 A 20...32A	25 kA 15 kA	25 kA 15 kA
Rated service short-circuit capacity $I_{cs}$ acc. to IEC/EN 60947-2 (only referring to short circuit test)	6...16 A 20...32A	15 kA 7.5 kA	15 kA 7.5 kA
Rated residual breaking capacity acc. to IEC/EN 61009-1 $I_{\Delta m}$	6000A	10000A	10000A
Rated impulse withstand voltage (1.2/50) $U_{imp}$	4 kV	4 kV	4 kV
Dielectric test voltage at ind. freq. for 1 min.	2.5 kV (50/60Hz, 1 min.)	2.5 kV (50/60Hz, 1 min.)	2.5 kV (50/60Hz, 1 min.)
Thermomagnetic release – characteristic	B: $3 I_n \leq I_n \leq 5 I_n$ C: $5 I_n \leq I_n \leq 10 I_n$	X	X
Energy limiting class acc. to EN 61009-1	3	3	3
<b>Mechanical features</b>			
Housing	Insulation group I, light grey RAL 7035	Insulation group I, light grey RAL 7035	Insulation group I, light grey RAL 7036
Toggle	Insulation group II, black RAL 9005, sealable in ON-OFF positions	Insulation group II, black RAL 9005, sealable in ON-OFF positions	Insulation group II, black RAL 9005, sealable in ON-OFF positions
Contact position indication	Green/Red Window	Green/Red Window	Green/Red Window
Endurance	Electrical endurance: 10000ops Mechanical endurance: 10000ops	Electrical endurance: 10000ops Mechanical endurance: 10000ops	Electrical endurance: 10000ops Mechanical endurance: 10000ops
IP code	IP20, IP40 in enclosure with cover	IP20, IP40 in enclosure with cover	IP20, IP40 in enclosure with cover
Shock resistance acc. to IEC/EN 61373	5g–30ms, 3 shocks	5g–30ms, 3 shocks	5g–30ms, 3 shocks
Vibration resistance acc. to IEC/EN 60068-2-6	2...13.2 Hz/1 mm 13.2...100Hz/0.7 g, 5 cycles 5...150 ... 5 Hz/1 g, 4 waves	2...13.2 Hz/1 mm 13.2...100Hz/0.7 g, 5 cycles 5...150 ... 5 Hz/1 g, 4 waves	2...13.2 Hz/1 mm 13.2...100Hz/0.7 g, 5 cycles 5...150 ... 5 Hz/1 g, 4 waves
Reference temperature for setting of thermal element	30°C	30°C	30°C
Ambient temperature	–25...+60°C	–25...+60°C	–25...+60°C
Storage temperature	–40...+70°C	–40...+70°C	–40...+70°C
<b>Installation</b>			
Terminal type	failsafe bi-directional cylinder-lift terminal (shock protected)		
Top terminal rigid IEC connections (solid/stranded)	Single: 0.75 ... 35 mm <sup>2</sup> (front slot), 0.75 ... 10 mm <sup>2</sup> (rear slot) Multiple: 2x0.75 ... 10 mm <sup>2</sup> (front slot), 2x0.75 ... 6 mm <sup>2</sup> (rear slot), with cables of same type and size		
Top terminal flexible IEC connections	Single: 0.75 ... 25 mm <sup>2</sup> (front side), 0.75 ... 6 mm <sup>2</sup> (rear slot) Multiple: 2x0.75 ... 10 mm <sup>2</sup> (front slot), 2x0.75 ... 6 mm <sup>2</sup> (rear slot), with cables of same type and size		

## RCBOs (3P+N)

FS403 series   A  type,  
B and C characteristics

### A Type:

Function: protection of end user against overload and short-circuit currents; protection against the

effects of sinusoidal alternating and direct pulsating earth fault currents.

### B, 10 kA according to EN 61009-1

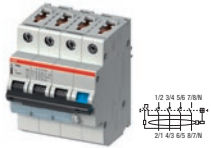

$I_{\Delta n}$ [mA]	$I_n$ [A]	$I_{cn}$ [kA]	Type name	ABB IT number	EAN number 761 227	Pack-aging unit	Module	Weight in grams
30	6	10	FS403M-B6/0.03	2CCL564110E0065	143 4434	1	4	410
30	10	10	FS403M-B10/0.03	2CCL564110E0105	140 7612	1	4	410
30	13	10	FS403M-B13/0.03	2CCL564110E0135	140 7629	1	4	410
30	16	10	FS403M-B16/0.03	2CCL564110E0165	140 7636	1	4	410
30	20	10	FS403M-B20/0.03	2CCL563110E0205	144 2576	1	4	410
30	25	10	FS403M-B25/0.03	2CCL563110E0255	144 2590	1	4	410
30	32	10	FS403M-B32/0.03	2CCL563110E0325	144 2613	1	4	410

### C, 6 kA according to EN 61009-1

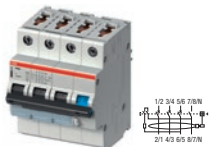

$I_{\Delta n}$ [mA]	$I_n$ [A]	$I_{cn}$ [kA]	Type name	ABB IT number	EAN number 761 227	Pack-aging unit	Module	Weight in grams
30	6	6	FS403E-C6/0.03	2CCL564111E0064	141 9141	1	4	410
30	10	6	FS403E-C10/0.03	2CCL564111E0104	143 4489	1	4	410
30	13	6	FS403E-C13/0.03	2CCL564111E0134	143 4519	1	4	410
30	16	6	FS403E-C16/0.03	2CCL564111E0164	143 4601	1	4	410
30	20	6	FS403E-C20/0.03	2CCL564111E0203	140 9609	1	4	410
30	25	6	FS403E-C25/0.03	2CCL564111E0254	140 8770	1	4	410
30	32	6	FS403E-C32/0.03	2CCL564111E0324	140 8787	1	4	410

### C, 10 kA according to EN 61009-1

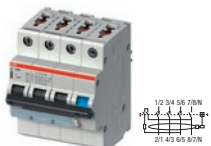

$I_{\Delta n}$ [mA]	$I_n$ [A]	$I_{cn}$ [kA]	Type name	ABB IT number	EAN number 761 227	Pack-aging unit	Module	Weight in grams
30	6	10	FS403M-C6/0.03	2CCL564110E0064	141 9127	1	4	410
30	10	10	FS403M-C10/0.03	2CCL564110E0104	140 7674	1	4	410
30	13	10	FS403M-C13/0.03	2CCL564110E0134	140 7681	1	4	410
30	16	10	FS403M-C16/0.03	2CCL564110E0164	140 7698	1	4	410
30	20	10	FS403M-C20/0.03	2CCL563110E0204	144 2569	1	4	410
30	25	10	FS403M-C25/0.03	2CCL563110E0254	144 2583	1	4	410
30	32	10	FS403M-C32/0.03	2CCL563110E0324	144 2606	1	4	410

### C, 10 kA according to EN 61009-1

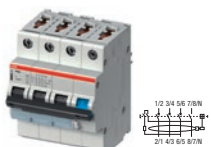

$I_{\Delta n}$ [mA]	$I_n$ [A]	$I_{cn}$ [kA]	Type name	ABB IT number	EAN number 761 227	Pack-aging unit	Module	Weight in grams
100	6	10	FS403M-C6/0.1	2CCL564121E0064	142 4527	1	4	410
100	10	10	FS403M-C10/0.1	2CCL564121E0104	142 4510	1	4	410
100	13	10	FS403M-C13/0.1	2CCL563120E0134	144 2620	1	4	410
100	16	10	FS403M-C16/0.1	2CCL564120E0164	142 0109	1	4	410
100	20	10	FS403M-C20/0.1	2CCL563120E0204	144 2637	1	4	410
100	25	10	FS403M-C25/0.1	2CCL563120E0254	144 2644	1	4	410
100	32	10	FS403M-C32/0.1	2CCL563120E0324	144 2651	1	4	410

Ordering details for auxiliary switch and signal contacts on page 56–57

## RCBOs (3P+N)

FS403 series 10000 F  type, AP-R (high immunity)



B and C characteristics

### Type F:



Function: protection of end user multipole-phase circuits against overload and short-circuit currents; protection against the effects of sinusoidal

alternating earth fault currents; protection against indirect contact and additional protection against direct contact ( $I_{\Delta n}=30\text{ mA}$ ). Specifically suitable for the protection of lines supplying inverters.



### B 10kA according to EN 61009-1

	$I_{\Delta n}$ [mA]	$I_n$ [A]	$I_{cn}$ [kA]	Type name	ABB IT number	EAN number 761 227	VPE	Module	Weight in grams
 	30	6	10	FS403MK-B6/0.03	2CCL564310E0065	147 0951	1	4	410
	30	10	10	FS403MK-B10/0.03	2CCL564310E0105	147 0999	1	4	410
	30	13	10	FS403MK-B13/0.03	2CCL564310E0135	147 1033	1	4	410
	30	16	10	FS403MK-B16/0.03	2CCL564310E0165	147 1071	1	4	410
	30	20	10	FS403MK-B20/0.03	2CCL563310E0205	147 0777	1	4	410
	30	25	10	FS403MK-B25/0.03	2CCL563310E0255	147 0814	1	4	410
	30	32	10	FS403MK-B32/0.03	2CCL563310E0325	147 0852	1	4	410

### C, 10kA according to EN 61009-1

	$I_{\Delta n}$ [mA]	$I_n$ [A]	$I_{cn}$ [kA]	Type name	ABB IT number	EAN number 761 227	VPE	Module	Weight in grams
 	30	6	10	FS403MK-C6/0.03	2CCL564310E0064	147 0937	1	4	410
	30	10	10	FS403MK-C10/0.03	2CCL564310E0104	147 0975	1	4	410
	30	13	10	FS403MK-C13/0.03	2CCL564310E0134	147 1019	1	4	410
	30	16	10	FS403MK-C16/0.03	2CCL564310E0164	147 1057	1	4	410
	30	20	10	FS403MK-C20/0.03	2CCL563310E0204	147 0753	1	4	410
	30	25	10	FS403MK-C25/0.03	2CCL563310E0254	147 0791	1	4	410
	30	32	10	FS403MK-C32/0.03	2CCL563310E0324	147 0838	1	4	410

### C, 10kA according to EN 61009-1

	$I_{\Delta n}$ [mA]	$I_n$ [A]	$I_{cn}$ [kA]	Type name	ABB IT number	EAN number 761 227	VPE	Module	Weight in grams
 	300	6	10	FS403MK-C6/0.3	2CCL564330E0064	147 1095	1	4	410
	300	10	10	FS403MK-C10/0.3	2CCL564330E0104	147 1118	1	4	410
	300	13	10	FS403MK-C13/0.3	2CCL564330E0134	147 1132	1	4	410
	300	16	10	FS403MK-C16/0.3	2CCL564330E0164	147 1156	1	4	410
	300	20	10	FS403MK-C20/0.3	2CCL563330E0204	147 0876	1	4	410
	300	25	10	FS403MK-C25/0.3	2CCL563330E0254	147 0890	1	4	410
	300	32	10	FS403MK-C32/0.3	2CCL563330E0324	147 0913	1	4	410

Ordering details for auxiliary switch and signal contacts on page 56–57

## Residual current operated circuit breaker (RCBO)

### FS402 technical features

		FS401MK
Standards		IEC/EN 61009-1, IEC/EN 61009-2-1 IEC/EN 62423
<b>Electrical features</b>		
type (wave form of the earth leakage sensed)		APR - F
Number of poles		1P + N (N is 100% protected)
Rated current $I_n$		$6 \leq I_n \leq 32\text{ A}$
Rated sensitivity $I_{\Delta n}$		0.03–0.3 A
Rated voltage $U_e$		240V
Insulation voltage $U_i$		500V
Overvoltage category		III
Pollution degree		2
Operating voltage of circuit test		110V (170 for 30mA) – 264V
Rated frequency		50/60Hz
Rated breaking capacity acc. to IEC/EN 61009-1 $I_{cn}$		10000A
Rated ultimate short-circuit capacity $I_{cu}$ acc. to IEC/EN 60947-2 (only referring to short circuit test)	6...16 A	25 kA
	20...32 A	15 kA
Rated service short-circuit capacity $I_{cs}$ acc. to IEC/EN 60947-2 (only referring to short circuit test)	6...16 A	15 kA
	20...32 A	7.5 kA
Rated residual breaking capacity acc. to IEC/EN 61009-1 $I_{\Delta m}$		10000A
Rated impulse withstand voltage (1.2/50) $U_{imp}$		4 kV
Dielectric test voltage at ind. freq. for 1 min.		2.5 kV (50/60Hz, 1 min.)
Thermomagnetic release – characteristic	B: $3 I_n \leq I_n \leq 5 I_n$	X
	C: $5 I_n \leq I_n \leq 10 I_n$	X
Energy limiting class acc. to EN 61009-1		3
<b>Mechanical features</b>		
Housing		Insulation group I, light grey RAL 7035
Toggle		Insulation group II, black RAL 9005, sealable in ON-OFF positions
Contact position indication		Green/Red Window
<b>Endurance</b>		
IP code		IP20, IP40 in enclosure with cover
Shock resistance acc. to IEC/EN 61373		5g–30ms, 3 shocks
Vibration resistance acc. to IEC/EN 60068-2-6	2...13.2 Hz/1 mm	
	13.2...100 Hz/0.7g, 5 cycles	
	5...150 ... 5 Hz/1g, 4 waves	
Reference temperature for setting of thermal element		30°C
Ambient temperature		–25...+60°C
Storage temperature		–40...+70°C
<b>Installation</b>		
Terminal type		
Top terminal rigid IEC connections (solid/stranded)		
Top terminal flexible IEC connections		

## RCBOs (1P+N)

FS402 series 10 000 F type, AP-R (high immunity)

B and C characteristics

### B characteristic

	$I_n$ [A]	$I_{cn}$ acc 61009	Type	ABB IT number	EAN number 761 227	Packaging unit	Module	Weight in grams
	6	10	FS402MK-B6/0.03	2CCL563130E1035	7612271473365	1	3	312
	10	10	FS402MK-B10/0.03	2CCL563010E0105	7612271473778	1	3	312
	13	10	FS402MK-B13/0.03	2CCL563310E1135	7612271473389	1	3	312
	16	10	FS402MK-B16/0.03	2CCL563010E0165	7612271474010	1	3	312
	20	10	FS402MK-B20/0.03	2CCL563010E0205	7612271474058	1	3	312
	25	10	FS402MK-B25/0.03	2CCL563010E0255	7612271474096	1	3	312
	32	10	FS402MK-B32/0.03	2CCL563010E0325	7612271474133	1	3	312

### C characteristic

	6	10	FS402MK-C6/0.03	2CCL563130E1034	7612271473341	1	3	312
	10	10	FS402MK-C10/0.03	2CCL563010E0104	7612271473754	1	3	312
	13	10	FS402MK-C13/0.03	2CCL563310E1324	7612271473402	1	3	312
	16	10	FS402MK-C16/0.03	2CCL563010E0164	7612271473792	1	3	312
	20	10	FS402MK-C20/0.03	2CCL563010E0204	7612271474034	1	3	312
	25	10	FS402MK-C25/0.03	2CCL563010E0254	7612271474072	1	3	312
	32	10	FS402MK-C32/0.03	2CCL563010E0324	7612271474119	1	3	312



# Residual current operated circuit breaker

Typ A 

Bi-directional cylindrical terminal ensure higher safety of connecting operations, making them easier.

Contact position indicator (CPI): to always know the status of the contacts (red: closed contacts; green: open contacts) independently on the toggle position

Test pushbutton to verify the correct functioning of the device.



Information on the device are laser printed to make them clearly visible and long lasting.

Plug contacts can be moved easily between L1, L2 and L3. Capacities, e.g. of battery systems, can be fully utilized. A different arrangement can be set up quickly and easily. Inspection glass with phase indicator on the front of the device.

## Residual current operated circuit breaker RCCBs

### F402 technical features, A type and APR-F (K type)

	F402	F402 APR
Standards	IEC/EN 61008-1 IEC/EN 61008-2-1	IEC/EN 61008-1 IEC/EN 61008-2-1 IEC/EN 62423
<b>Electrical features</b>		
Type (wave form of the earth leakage sensed)	A	APR - F
Number of poles	1P + N	1P + N
Rated current $I_n$	25, 40 A	40 A
Rated sensitivity $I_{\Delta n}$	0.01, 0.03, 0.1 A	0.03 A
Rated voltage $U_e$	230 V	230/400 V
Rated insulation voltage ( $U_i$ )	500 V	500 V
Overvoltage category	III	III
Pollution degree	2	2
Operating voltage of circuit test	110 V (170 for 30 mA) – 254 V	170 – 254 V
Rated frequency	50/60 Hz	50/60 Hz
Rated conditional short-circuit current $I_{nc}$	10 kA with SCPD - fuse gG 100 A or high performance MCB S800 100 A	
Rated residual breaking capacity $I_{\Delta m}$	1 kA	
Surge current resistance (wave 8/20)	N/A	3000 A
<b>Mechanical features</b>		
Housing	light grey RAL 7035	light grey RAL 7035
Toggle	blue RAL 5015, sealable in ON-OFF positions	blue RAL 5015, sealable in ON-OFF positions
Contact position indication	Green/Red Window	Green/Red Window
Endurance	Electrical endurance: 10000 ops Mechanical endurance: 10000 ops	Electrical endurance: 10000 ops Mechanical endurance: 10000 ops
IP code	IP20, IP40 in enclosure with cover	IP20, IP40 in enclosure with cover
Shock resistance acc. to IEC/EN 61373	5 g – 30 ms, 3 shocks	5 g – 30 ms, 3 shocks
Vibration resistance acc. to IEC/EN 60068-2-6	2 ... 13.2 Hz/1 mm 13.2 ... 100 Hz/0.7 g, 5 cycles 5 ... 150 ... 5 Hz/1 g, 4 waves	2 ... 13.2 Hz/1 mm 13.2 ... 100 Hz/0.7 g, 5 cycles 5 ... 150 ... 5 Hz/1 g, 4 waves
Environmental conditions (damp heat) acc. to IEC/EN 60068-2-30	28 cycles with 55 °C/90...96% and 25 °C/95...100%	
Ambient temperature	–25 ... +55 °C	–25 ... +55 °C
Storage temperature	–40 ... +70 °C	–40 ... +70 °C
<b>Installation</b>		
Terminal type	failsafe bi-directional cylinder-lift terminal (shock protected)	
Top terminal rigid IEC connections (solid/stranded)	Single: 0.75...25 mm <sup>2</sup> (front slot), 0.75...10 mm <sup>2</sup> (rear slot) Multiple: 2x0.75...10 mm <sup>2</sup> (front slot), 2x0.75...6 mm <sup>2</sup> (rear slot), with cables of same type and size	
Top terminal flexible IEC connections	Single: 0.75...16 mm <sup>2</sup> (front side), 0.75...6 mm <sup>2</sup> (rear slot) Multiple: 2x0.75...10 mm <sup>2</sup> (front slot), 2x0.75...6 mm <sup>2</sup> (rear slot), with cables of same type and size	

## Residual current operated circuit breaker RCCBs

### F404 technical features, A type and APR-F (K type)

	F404 A	F404 A-K	F404 S	F404 LF
Standards	IEC/EN 61008-1 IEC/EN 61008-2-1	IEC/EN 61008-1 IEC/EN 61008-2-1 IEC/EN 62423	IEC/EN 61008-1 IEC/EN 61008-2-1	IEC/EN 61008-1 IEC/EN 61008-2-1
<b>Electrical features</b>				
Type (wave form of the earth leakage sensed)	A	APR - F	A	A
Number of poles	3P + N	3P + N	3P + N	3P + N
Rated current $I_n$	25, 40, 63 A	40, 63 A	63 A	63 A
Rated sensitivity $I_{\Delta n}$	0.03, 0.1, 0.3 A	0.03–0.1 A	0.1, 0.3 A	0.03, 0.3 A
Rated voltage $U_e$	230/400V	230/400V	230/400V	230/400V
Rated insulation voltage (U <sub>i</sub> )	500V	500V	500V	500V
Overvoltage category	III	III	III	III
Pollution degree	2	2	2	2
Operating voltage of circuit test	110V (170 for 30 mA) – 254V	110V (170 for 30 mA) – 254V	110 – 254V	110 (170 for 30 mA) – 254V
Rated frequency Hz	50/60Hz	50/60Hz	50/60Hz	16 <sup>2/3</sup> Hz
Rated conditional short-circuit current $I_{nc}$	10 kA with SCPD – fuse gG 100A or high performance MCB S800 100A			
Rated residual breaking capacity $I_{\Delta m}$	1 kA	1 kA	1 kA	1 kA
Surge current resistance (wave 8/20)	N/A	3000A	5000A	N/A
<b>Mechanical features</b>				
Housing	Insulation group I, light grey RAL 7035	Insulation group I, light grey RAL 7035	Insulation group I, light grey RAL 7035	Insulation group I, light grey RAL 7035
Toggle	Insulation group II, blue RAL 5015, sealable in ON-OFF positions	Insulation group II, blue RAL 5015, sealable in ON-OFF positions	Insulation group II, blue RAL 5015, sealable in ON-OFF positions	Insulation group II, blue RAL 5015, sealable in ON-OFF positions
Contact position indication	Green/Red Window	Green/Red Window	Green/Red Window	Green/Red Window
Endurance	Electrical endurance: 10000 ops Mechanical endurance: 10000 ops	Electrical endurance: 10000 ops Mechanical endurance: 10000 ops	Electrical endurance: 10000 ops Mechanical endurance: 10000 ops	Electrical endurance: 10000 ops Mechanical endurance: 10000 ops
IP code	IP20, IP40 in enclosure with cover	IP20, IP40 in enclosure with cover	IP20, IP40 in enclosure with cover	IP20, IP40 in enclosure with cover
Shock resistance acc. to IEC/EN 61373	5 g – 30 ms, 3 shocks	5 g – 30 ms, 3 shocks	5 g – 30 ms, 3 shocks	5 g – 30 ms, 3 shocks
Vibration resistance acc. to IEC/EN 60068-2-6	2 ... 13.2 Hz/1 mm, 13.2 ... 100 Hz/0.7 g, 5 cycles, 5 ... 150 ... 5 Hz/1 g, 4 waves			
Environmental conditions (damp heat) acc. to IEC/EN 60068-2-30	28 cycles with 55 °C/90 ... 96 % and 25 °C/95 ... 100 %			
Ambient temperature	–25 ... +55 °C	–25 ... +55 °C	–25 ... +55 °C	–25 ... +55 °C
Storage temperature	–40 ... +70 °C	–40 ... +70 °C	–40 ... +70 °C	–40 ... +70 °C
<b>Installation</b>				
Terminal type	failsafe bi-directional cylinder-lift terminal (shock protected)			
Top terminal rigid IEC connections (solid/stranded)	Single: 0.75...25 mm <sup>2</sup> (front slot), 0.75...10 mm <sup>2</sup> (rear slot) Multiple: 2x0.75...10 mm <sup>2</sup> (front slot), 2x0.75...6 mm <sup>2</sup> (rear slot), with cables of same type and size			
Top terminal flexible IEC connections	Single: 0.75...16 mm <sup>2</sup> (front side), 0.75...6 mm <sup>2</sup> (rear slot) Multiple: 2x0.75...10 mm <sup>2</sup> (front slot), 2x0.75...6 mm <sup>2</sup> (rear slot), with cables of same type and size			

#### Tripping time settings type A

Tripping time

Type	Rated sensitivity	Tripping time			
	Alternating current	1 x $I_{\Delta n}$	2 x $I_{\Delta n}$	5 x $I_{\Delta n}$	500 A
	Pulsating current with DC components	1,4 x $I_{\Delta n}$	2 x 1,4 x $I_{\Delta n}$	5 x 1,4 x $I_{\Delta n}$	500 A
	Detection of smooth DC currents	2 x $I_{\Delta n}$	2 x 2 x $I_{\Delta n}$	5 x 2 x $I_{\Delta n}$	500 A
Standard or short time		max. 0,3 s	max. 0,15 s	max. 0,04 s	max. 0,04 s

# RCCBs

## F402, F404 series A type

F404 Type A, protection against the effects of sinusoidal alternating and direct pulsating earth fault currents; protection against indirect contacts and additional protection against direct contacts (with  $I_{\Delta n}=30$  mA).

### 2-pole residual current operated circuit breaker, series F402 (RCCB)

$I_{\Delta n}$ mA	$I_n$ A	Type name	ABB IT number	EAN number 801 254	Pack- aging unit	Module	Weight in grams
10	25	F402 25 A10	2CSF502110R0250	203 7033	1	2	187
30	25	F402 25 A30	2CSF502110R1250	203 4339	1	2	187
30	40	F402 40 A30	2CSF502110R1400	203 6937	1	2	187
100	40	F402 40 A100	2CSF502110R2400	203 4230	1	2	187



### 2-pole short time delayed residual current operated circuit breaker, series F402 K

30	40	F402 40 APR30	2CSF502410R1400	203 6838	1	2	187
----	----	---------------	-----------------	----------	---	---	-----

### 4-pole residual current operated circuit breaker, series F404 (RCCB)

30	25	F404 A 25/0.03	2CCF544110E0250	010 4253	1	4	430
30	40	F404 A 40/0.03	2CCF544110E0400	010 4260	1	4	430
100	40	F404 A 40/0.1	2CCF544120E0400	010 4277	1	4	430
300	40	F404 A 40/0.3	2CCF544130E0400	010 4284	1	4	430
30	63	F404 A 63/0.03	2CCF544110E0630	010 4291	1	4	430
100	63	F404 A 63/0.1	2CCF544120E0630	010 4307	1	4	430
300	63	F404 A 63/0.3	2CCF544130E0630	010 4314	1	4	430



### 4-pole short time delayed residual current operated circuit breaker, series F404 K (RCCB)

30	40	F404 A-K 40/0.03	2CCF544310E0400	010 4321	1	4	430
100	40	F404 A-K 40/0.1	2CCF544320E0400	010 4338	1	4	430
30	63	F404 A-K 63/0.03	2CCF544310E0630	010 4345	1	4	430

### 4-pole selective residual current operated circuit breaker, series F404 S (RCCB)

100	63	F404 A-S 63/0.1	2CCF544220E0630	010 4352	1	4	430
300	63	F404 A-S 63/0.3	2CCF544230E0630	010 4369	1	4	430

### 4-pole residual current operated circuit breaker, special design $16^{2/3}$ Hz, series F404 LF (RCCB)

30	63	F404 A-LF 63/0.03	2CCF544110E0631	010 4376	1	4	430
300	63	F404 A-LF 63/0.3	2CCF544130E0631	010 4383	1	4	430

Ordering details for auxiliary switch and signal contacts on page 56–57

# Residual current operated circuit breaker RCCBs

Type B   

F404 B RCCBs offer protection against direct contact and are the correct choice to guarantee maximum operational reliability through early detection of smooth DC residual currents at high frequencies.

## Advantages

- High interference resistance in exceedingly harsh weather conditions due to ambient temperatures from  $-25$  to  $+50^{\circ}\text{C}$
- High level of system availability due to high surge current withstand capacity of 3 kA (or optionally 5 kA) and 10 ms short-time delay
- Coordination and back-up protection with ABB devices

Terminals for comfortable, safe and flexible wiring.

Reliable recognition of the switching status through red/green position indicating device and position of the switching knob.

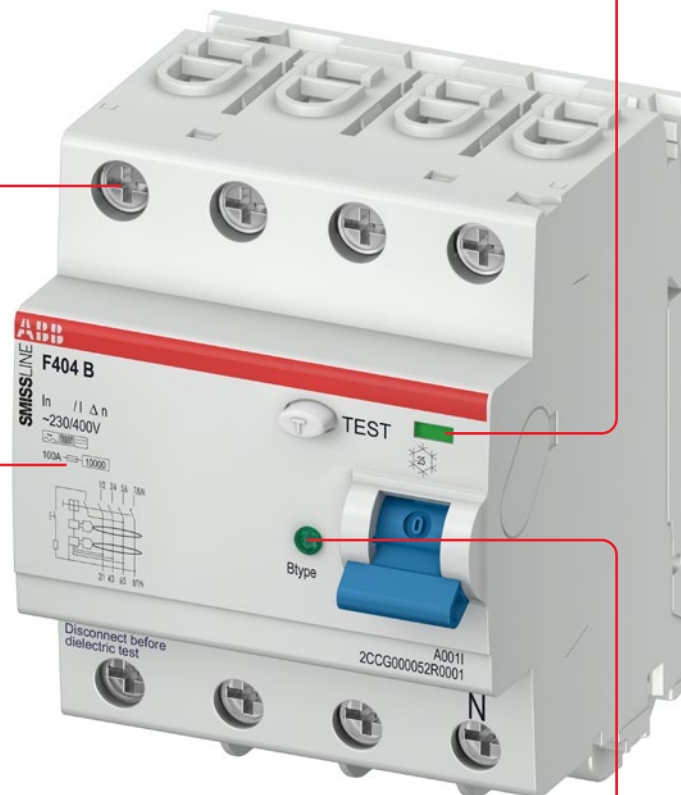

Identification marking according to EN 62423. Simple identification of the fields of application via symbols showing the forms of residual current.

Green LED to monitor the operating condition:

- RCCB with Type B functionality
- RCCB only with Type A and Type F functionality

## Residual current operated circuit breaker RCCBs

### F404 technical features, B type

<b>F404 B</b>	
Standards	IEC/EN 61008-1 IEC/EN 61008-2-1 IEC/EN 62423"
<b>Electrical features</b>	
Type (wave form of the earth leakage sensed)	B
Number of poles	3P + N
Rated current $I_n$	25, 40, 63 A
Rated sensitivity $I_{\Delta n}$	0.03, 0.3 A
Rated voltage $U_e$	230/400V
Rated insulation voltage ( $U_i$ )	500V
Overvoltage category	III
Pollution degree	2
Operating voltage of circuit test	110V (170 for 30 mA) – 254V
Rated frequency	50/60Hz
Rated conditional short-circuit current $I_{nc}$	10kA with SCPD – fuse gG 100A or high performance MCB S800 100 A
Rated residual breaking capacity $I_{\Delta m}$	1 kA
Surge current resistance (wave 8/20)	3000A
Maximum electronic consumption	1.2 W
<b>Mechanical features</b>	
Housing	light grey RAL 7035
Toggle	blue RAL 5015, sealable in ON-OFF positions
Contact position indication	Green/Red Window
Electrical life	10000 operations
Mechanical life	10000 operations
IP code	IP20, IP40 in enclosure with cover
Shock resistance acc. to IEC/EN 61373	5 g – 30 ms, 3 shocks
Vibration resistance acc. to IEC/EN 60068-2-6	2 ... 13.2 Hz/1 mm 13.2 ... 100 Hz/0.7 g, 5 cycles 5 ... 150 ... 5 Hz/1 g, 4 waves
Environmental conditions (damp heat) acc. to IEC/EN 60068-2-30	28 cycles with 55 °C/90...96% and 25 °C/95...100%
Ambient temperature	–25...+70 for system current ≤ 32 A –25...+65 for system current = 40 A –25...+50 for system current = 63 A
Storage temperature	–40 ... +70 °C
<b>Installation</b>	
Terminal type	failsafe bi-directional cylinder-lift terminal (shock protected)
Top terminal rigid IEC connections (solid/stranded)	Single: 0.75...25 mm <sup>2</sup> (front slot), 0.75...10 mm <sup>2</sup> (rear slot) Multiple: 2x0.75...10 mm <sup>2</sup> (front slot), 2x0.75...6 mm <sup>2</sup> (rear slot), with cables of same type and size
Top terminal flexible IEC connections	Single: 0.75...16 mm <sup>2</sup> (front side), 0.75...6 mm <sup>2</sup> (rear slot) Multiple: 2x0.75...10 mm <sup>2</sup> (front slot), 2x0.75...6 mm <sup>2</sup> (rear slot), with cables of same type and size

## RCCBs

F 404 series – B type for continuous, selective continuous type fault currents  
 technical features

F404 B RCCBs provide additional protection against direct contact and are the right choice to ensure maximum system safety thanks to early detection of fault currents with continuous wave-forms or high frequencies.



$I_{\Delta n}$ mA	$I_n$ A	Type name	ABB IT number	EAN number 761 227	Pack- aging unit	Modules	Weight in grams
30	25	F404 B 25/0.03	2CCG000052R0001	150 6285	1	4	435
30	40	F404 B 40/0.03	2CCG000053R0001	150 6292	1	4	435
30	63	F404 B 63/0.03	2CCG000054R0001	150 6308	1	4	435
300	25	F404 B 25/0.3	2CCG000055R0001	150 6315	1	4	435
300	40	F404 B 40/0.3	2CCG000056R0001	150 6322	1	4	435
300	63	F404 B 63/0.3	2CCG000057R0001	150 6339	1	4	435



Ordering details for auxiliary switch and signal contacts on page 56–57

## Surge arrester (SPD)

### Type 2 QuickSafe®-Technologie

Type 2 surge protective device of the SMISLINE QuickSafe series are suitable for protection of low-voltage electrical systems and terminal devices in the 240/415 V system. The high nominal discharge capacity of 20 kA enables a longer service life to be achieved compared to the

minimum requirements in the standard. The devices consist of a basic unit and plug-in protection modules that can be very easily removed in order to perform the insulation measurement.

Integrated signal contact

Can be plugged directly onto the socket system

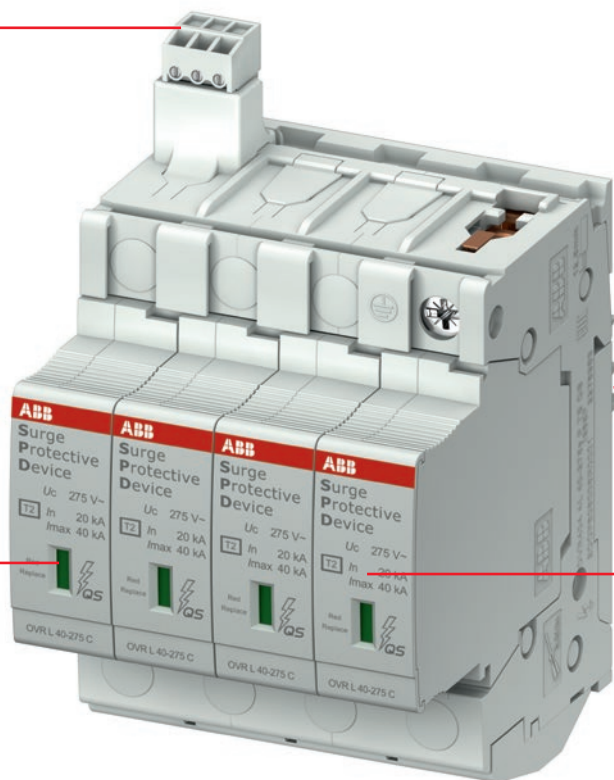

The end of the service life is displayed

Plug-in cartridges can be changed if required



## Surge arrester (SPD)

### OVR404 technical features

Type	OVR404 4L 40-275 P TS QS	OVR404 3N 40-275 P TS QS
Technology	varistor	Varistor/gaz tube (N)
System network	TNS	TT-TNS
<b>Electrical features</b>		
Standard	IEC 61643-11/EN 61643-11	IEC 61643-11/EN 61643-11
Type / test class	Type 2	Type 2
Number of pole	4	4
Nominal voltage UN (L-N, L-L)	240/415V	240/415V
Type of voltage	a. c. 45–65 Hz	a. c. 45–65 Hz
Max. cont. operating voltage U <sub>c</sub>	275 V AC	275 V AC
Nominal discharge current I <sub>n</sub> (8/20)	20 kA	20 kA
Maximum discharge current I <sub>max</sub> (8/20)	40 kA	40 kA
Maximum impulse current I <sub>imp</sub> (10/350)	2 kV	2 kA
Voltage protection level U <sub>p</sub> at I <sub>n</sub> (L-N / N-PE / L-PE)	1.5 kV	1.25/1.4/1.5 kV
Voltage protection level U <sub>p</sub> at 3 kA (L-N / N-PE / L-PE)	0.5 kV	0.8/1.4/0.85 kV
Voltage protection level U <sub>p</sub> at 5 kA (L-N / N-PE / L-PE)	0.7 kV	0.85/1.4/0.95 kV
Voltage protection level U <sub>p</sub> at 10 kA (L-N / N-PE / L-PE)	0.9 kV	1/1.4/1.15 kV
TOV (Temporary overvoltage) withstand U <sub>t</sub> (L-N: 5s./N-PE: 200ms)	337/-V	337/1200V
Response time	≤ 25 ns	≤ 25 ns
Short-circuit withstand capability I <sub>sc</sub>	100 kA	100 kA
Back up protection circuit breaker	≤ 125 A; S800S B	≤ 125 A; S800S B
Pluggable cartridge	Yes	Yes
Integrated QuickSafe® technology	Yes	Yes
State indicator	Yes	Yes
Auxiliary contact (TS)	Yes	Yes
<b>Installation</b>		
Wire range (L, N, PE)	2.5...25 mm <sup>2</sup> cable or rope	2.5...25 mm <sup>2</sup> cable or rope
Connection cross-section	2.5...16 mm <sup>2</sup> litz wire with ferrule	2.5...16 mm <sup>2</sup> litz wire with ferrule
Tightening torque	2.8 Nm	2.8 Nm
<b>Auxiliary contact (TS)</b>		
Contacts information	1 NO – 1 NC	1 NO – 1 NC
Max. load/current	12 V DC – 10 mA	12 V DC – 10 mA
Min. load/current	250 V AC – 1 A 1.5 mm <sup>2</sup>	250 V AC – 1 A 1.5 mm <sup>2</sup>
Operating temperature	–25 °C – +60 °C	–25 °C – +60 °C
Storage temperature	–25 °C – +80 °C	–25 °C – +80 °C

#### Back up protection

Typ 2 QuickSafe® Surge Protective Devices	Prospective short circuit current at SPD location (I <sub>p</sub> )	Circuit breaker maximum ratings <sup>1)</sup> curve B or C	Fuse <sup>2)</sup> (gL - gG)	MCCB
Maximum ratings I <sub>n</sub> : 5, 20, 30 kA U <sub>c</sub> : 275, 350, 440, 600 V	0,625 kA < I <sub>p</sub> < 100 kA	S800S B or C – 125 A <sup>2)</sup>	125 A fuse	250 A XT4 (see settings below)

<sup>1)</sup> Maximum ratings, must be in accordance with the installation to follow coordination rules with main or upstream short circuit protection(s).

<sup>2)</sup> up to I<sub>p</sub> ≤ 50 kA

#### Settings for XT4

- N = ON – 100%
- I1 = I<sub>n</sub> \* 1
- t1(s) = 3
- I2 = I<sub>n</sub> \* 10
- t2(s) = 0,1
- I = 10 I<sub>n</sub> = L
- I3 = I<sub>n</sub> \* 3,5
- LOC
- MAN

## Surge arrester Type 2

OVR Type 2 surge protective devices are designed to protect electric installations and sensitive equipment against indirect surges with ensuring

a low protection level ( $U_p$ ). They are characterized by their capacity to safely discharge current with 8/20  $\mu$ s wave form.

### Surge arrester OVR404

$I_{sn}$ (8/20 $\mu$ s) [kA]	Type name	ABB IT number	EAN number	Packaging unit	Module	Weight in grams
20	OVR404 4L 40-275 P TS QS	2CCF606000R0001	761 227 145 5491	1	4	470
20	OVR404 3N 40-275 P TS QS	2CCF606002R0001	761 227 145 5507	1	4	450
20	OVR404 4L 40-440 P TS QS	2CCF606000A0003	761 227 146 5322	1	4	470

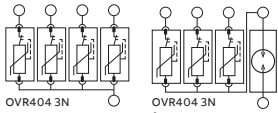

OVR404 3N  
for TT or TNS  
systems

OVR404 3N  
for TT or TNS  
systems

# IS404 technical details

## Switch disconnecter

### Technical data for switch disconnecter IS404

Rated voltage $U_n$	230/400V~
Rated current $I_n$	63A
Rated frequency $f_n$	50Hz
Number of poles	4
Rated impulse withstand voltage	6kV
Connection cross-sections $C_u$	<p>Top terminal type: Failsafe bi-directional cylinder-lift terminal with double slot 25/10mm<sup>2</sup></p> <p>Top terminal rigid IEC connections (solid/stranded):</p> <ul style="list-style-type: none"> <li>– Single: 0.75 ... 25mm<sup>2</sup> (front slot), 0.75 ... 10mm<sup>2</sup> (rear slot)</li> <li>– Multiple: 2x0.75 ... 10mm<sup>2</sup> (front slot), 2x0.75 ... 6mm<sup>2</sup> (rear slot), with cables of same type and size</li> </ul> <p>Top terminal flexible IEC connections:</p> <ul style="list-style-type: none"> <li>– Single: 0.75 ... 16mm<sup>2</sup> (front side), 0.75 ... 6mm<sup>2</sup> (rear slot)</li> <li>– Multiple: 2x0.75 ... 10mm<sup>2</sup> (front slot), 2x0.75 ... 6mm<sup>2</sup> (rear slot), with cables of same type and size</li> </ul>
IP Code	IP20, IP40 in enclosure with cover
Endurance, mechanical/electrical	<p>Electrical endurance: 10000ops</p> <p>Mechanical endurance: 20000ops</p>
Mounting position	any
Ambient temperature	-25°C ... +60°C
Standard	EN/IEC 60947-3
Environmental conditions (damp heat) acc. to IEC/EN 60068-2-30	28 cycles with 55°C/90...96% and 25°C/95...100%
Weight (approx.)	250g
Switching duty	AC-22A

# Switch disconnector

## General switch disconnector

When used in a smissline socket system, the switch disconnector can be used instead of the incoming terminal block for up to 63A.

With the smissline IS404 switch disconnector, individual loads, groups of loads or entire system parts can be separated or connected to the input supply.

The key features of the switch disconnector

- Input supply switch
- On-Off function
- Clear indication of switching position
- Snap-on auxiliary switch available
- Uniform smissline design

## Switch disconnector IS404

In [A]	Type name	ABB IT number	EAN number 761 227	Pack-aging unit	Module	Weight in grams
63	IS404 63	2CCF544160E0630	010 4390	1	4	380



Ordering details for auxiliary switch and signal contacts on page 41–45

## Cover switch disconnector IS404/F404

The Cover is for the Incoming terminals

Type name	ABB IT number	EAN number 761 227	Pack-aging unit	Weight in grams
ZFI301	2CCA601560R0001	142 0451	1	1



# Auxiliary switches and signal contacts SK400, HK400

## Description, technical features



### General

The auxiliary switches and signal contacts are snapped on to the left of the protective devices. On the miniature circuit breakers an optional mounting on the right is also possible.

For auxiliary switches and signal contacts supplied via SMISLINE auxiliary busbars LA or LB a version with integrated contacting pieces is available. Conventional supply via the terminals of the auxiliary devices is possible.



### Function

The auxiliary switch works in the same way as the main contacts. The signal contact only operates when the protective device trips.

This can be simulated with the white test button. Each time the signal contact is tripped, it must be reset to its starting position using the orange-coloured reset button.

Auxiliary switch and signal contacts have special contacts which ensure high switching reliability even in systems with low voltages or low currents (PLC, signal systems etc.).

Auxiliary switch contacts operate at the same time as the contacts of the protective device (activated manually or automatically).

Normally open contact

**NO**



joint operation with protective device

Normally close contact

**NC**



opposing operation with protective device



Signal contacts only operate when the protective device is tripped electrically as a result of a short-circuit, a fault current or overcurrent.

Normally open contact

**NO**



closes during automatic trip

Normally close contact

**NC**



opens during automatic trip



### Technical data for auxiliary switch and signal contact

	Signal contact SK400	Auxiliary switch HK400
Rated voltage $U_n$	400V	400V
Rated impulse withstand voltage $U_{imp}$	4kV	4kV
Rated current		
– $I_{th}$	6A	6A
– AC15	2A/230V / 1A/400V	2A/230V / 1A/400V
– DC13	0.55A/125V=	0.55A/125V=
– DC13	0.27A/250V=	0.27A/250V=
Minimum current/voltage (to ensure reliable electrical operation)	10mA 12V=	10mA 12V=
Connection cross-sections	Rigid IEC connections (solid/stranded) Single: 0.75 ... 1.5 mm <sup>2</sup> , Multiple: 2x0.75 ... 1.5 mm <sup>2</sup> , Flexible IEC connections Single: 0.75 ... 1.5 mm <sup>2</sup> , Multiple: 2x0.75 ... 1.5 mm <sup>2</sup> , Stripping length 7.5 mm	
Internal resistance $R_i$	0.0065Ω	0.0065Ω
Power loss at rated current $P_v$	0.24W	0.24W
Environmental conditions (damp heat) acc. to IEC/EN 60068-2-30	28 cycles with 55°C/90...96% and 25°C/95...100%	
Ambient temperature	Tmax. +55°C Tmin –25°C	Tmax. +55°C Tmin –25°C
Tightening torque	1 Nm	1 Nm

# Accessory mounting

## Options for protective devices

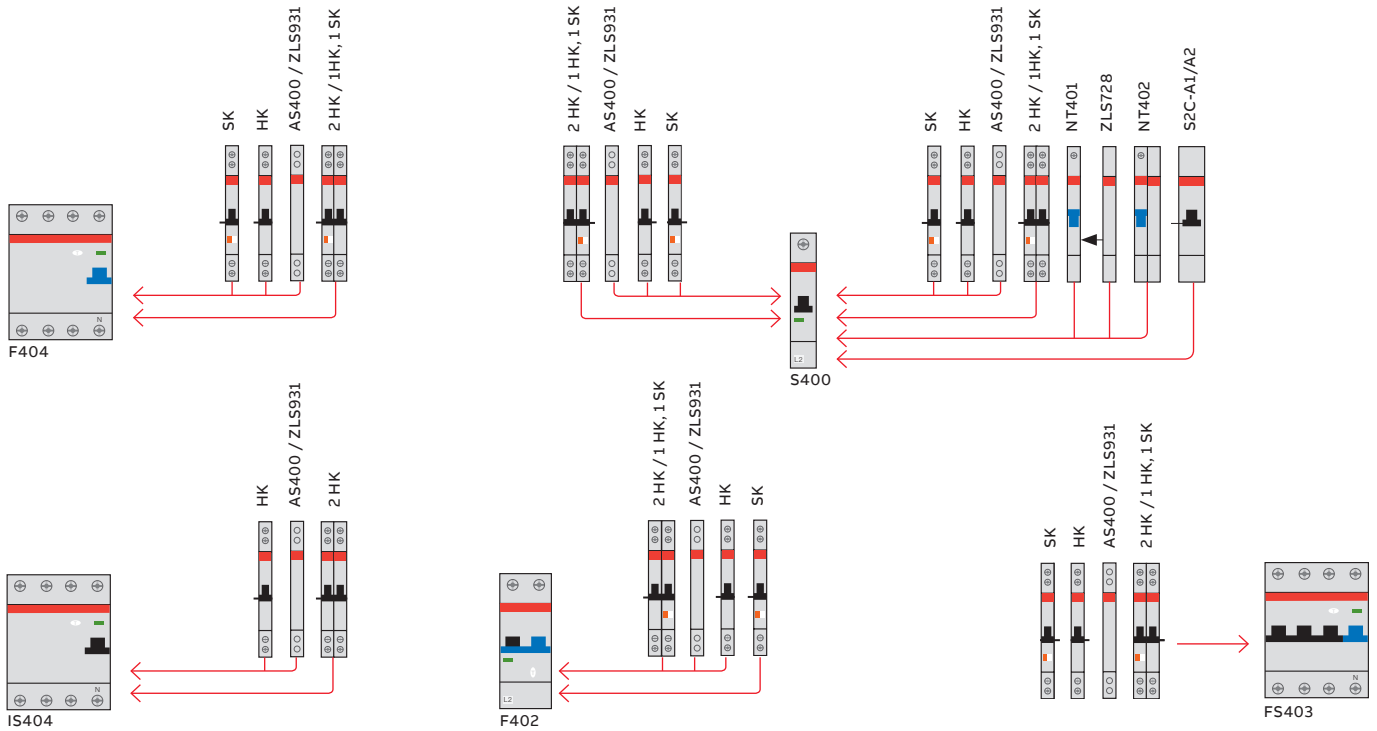

On each protective device can be mounted:

- 1 auxiliary switch
- or 1 signal contact
- or 2 auxiliary contact switches
- or 1 auxiliary switch and 1 signal contact

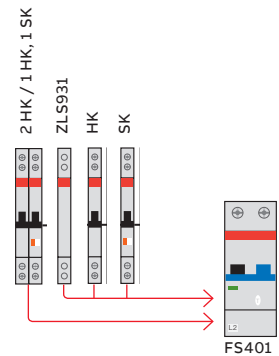

### Contact description signal contact

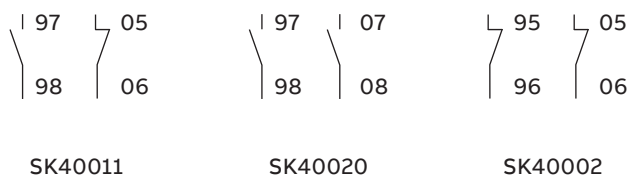

### Contact description auxiliary switch

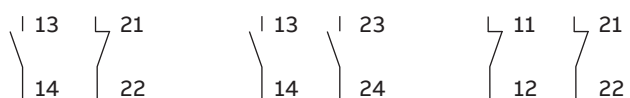

# Auxiliary switch and signal contacts



## S400, F402, F404, FS401, FS402, IS404

The auxiliary switch and signal contacts are supplied with one contacting piece.  
 The signal contact collective alarm are supplied with two contacting pieces.

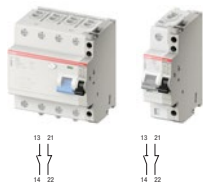

### Auxiliary switch

	Type name	ABB IT number	EAN number 761 227	Pack-aging unit	Module	Weight in grams
<b>for left side mounting on MCB S400, RCBO FS401, FS403</b>						
	1NO and 1NC	HK40011-L	2CCS500900R0081	010 0910	10	0.5 45
	2NO	HK40020-L	2CCF201112R0001	011 1183	10	0.5 40
	2NC	HK40002-L	2CCF201114R0001	011 1190	10	0.5 40
<b>for right side mounting on RCB F404/402, MCB S400 and IS404</b>						
	1NO and 1NC	HK40011-R	2CCS500900R0214	010 8619	10	0.5 45
	2NO	HK40020-R	2CCF201113R0001	011 1206	10	0.5 40
	2NC	HK40002-R	2CCF201115R0001	011 1213	10	0.5 40

### Signal contacts

	Type name	ABB IT number	EAN number 761 227	Pack-aging unit	Module	Weight in grams
<b>for left side mounting on MCB S400, RCBO FS401, FS403</b>						
	1NO and 1NC	SK40011-L	2CCS500900R0101	010 0934	10	0.5 45
	2NO	SK40020-L	2CCF201162R0001	011 1107	10	0.5 40
	2NC	SK40002-L	2CCF201164R0001	011 1114	10	0.5 40
<b>for right side mounting on RCB F404/402, MCB S400 and IS404</b>						
	1NO and 1NC	SK40011-R	2CCS500900R0215	010 8626	10	0.5 45
	2NO	SK40020-R	2CCF201163R0001	011 1121	10	0.5 40
	2NC	SK40002-R	2CCF201165R0001	011 1138	10	0.5 40

### Signal contact collective alarm and auxiliary contact

	Type name	ABB IT number	EAN number 761 227	Pack-aging unit	Module	Weight in grams
<b>for left side mounting S400, RCBO FS401, FS403</b>						
	1NO	SK40010-L SA	2CCS500900R0141	010 7964	10	0.5 45
	1NO	HK40010-L SA	2CCF201212R0001	140 7902	10	0.5 45
<b>for right side mounting F404/402, MCB S400 and IS404</b>						
	1NO	SK40010-R SA	2CCS500900R0216	010 8633	10	0.5 45
	1NO	HK40010-R SA	2CCF201213R0001	140 7919	10	0.5 45

### Collective alarm, signal contact contacts the auxiliary busbars LA, LB

A cost-effective collective alarm solution can be implemented without additional wiring by using this arrangement.

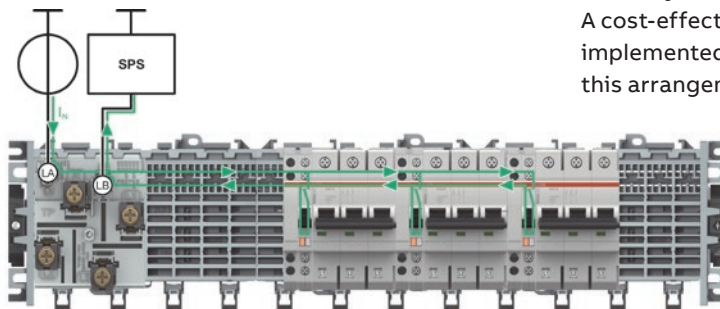

# Dummy, housing, Neutral disconnecter, shunt trip

## Connection support dummy housing

for left or right side mounting on MCB S400, RCCB F402, RCCB F404, RCBO FS401

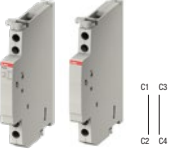
Connection support	Type name	ABB IT number	EAN number 761 227	Pack-aging unit	Module	Weight in grams	
	AS400	2CCS500900R0151	010 0958	10	0.5	45	
	<b>Dummy housing</b>						
	Compensation to 18 mm	ZLS931	2CCS500900R0161	010 0965	10	0.5	35

## Contacting pieces for auxiliary switch and signal contacts

Connection support	Type name	ABB IT number	EAN number 761 227	Pack-aging unit	Module	Weight in grams
	Contacting piece for HK/SK LA, LB Pack contains 100 items	ZLS632	2CCS500900R0171	010 0972	Pack contains 100 items	200
	Contacting piece for HK/SK LA, LB Pack contains 10 items	ZLS635	2CC5201307R0171	010 9265	Pack contains 10 items	20
	Contact Pin	ZLS633	2CCS500900R0201	010 8640	Pack contains 10 items	20

## Neutral disconnecter

On the load side terminal two separate conductors can be clamped

Connection support	Type name	ABB IT number	EAN number 761 227	Pack-aging unit	Module	Weight in grams	
	Neutral disconnecter 9 mm	NT401 63	2CCS500900R0021	010 0859	10	0.5	45
	Neutral disconnecter 18 mm	NT402 63	2CCS500900R0011	010 0842	10	1	58
	Compensation to 18 mm for NT401 63	ZLS728	2CCS400900R0101	010 4710	1 Bag contains 5 items	0.5	15

## Shunt trip

Function: remote opening of the device when a voltage is applied. Suitable for MCBs S400 series.

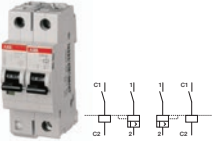
Rated voltage	Type name	ABB IT number	EAN number 761 227	Pack-aging unit	Module	Weight in grams
	12–60VAC/DC	S 2C-A1	2CDS 200 909 R0001	257 0992	1	150
	110–415VAC/DC, 110–250VDC	S 2C-A2	2CDS 200 909 R0002	257 1005	1	1



## Auxiliary switch and signal contacts for SUP400

### Auxiliary switch



	Type name	ABB IT number	EAN number	Pack-aging unit	Module	Weight in grams
<b>Auxiliary switch for right side mounting</b>						
changeover contact	S2C-H6RU	2CDS200914R0001	401 677 961 5617	1	0.5	6
<b>Signal switch for right side mounting</b>						
changeover contact	S2C-S6RU	2CDS200924R0001	401 677 961 5624	1	0.5	6
<b>Dummy housing Compensation to 18 mm</b>						
	E210-DHR	2CCA703488R0001	761 227 144 1708	1	0.5	18

---

# Table of contents

<b>01. Overview, Technical data</b>	66–68
<b>02. Startpakete 125 A</b>	69–72
<b>03. Main socket, Additional socket 125 A</b>	73–74
<b>04. Incoming terminal block, components</b>	75–77
<b>05. Terminals for additional socket</b>	78–80
<b>06. Socket accessories</b>	81
<b>07. Busbars 125 A, 40 A</b>	82

# Busbar system 125 A

## Overview

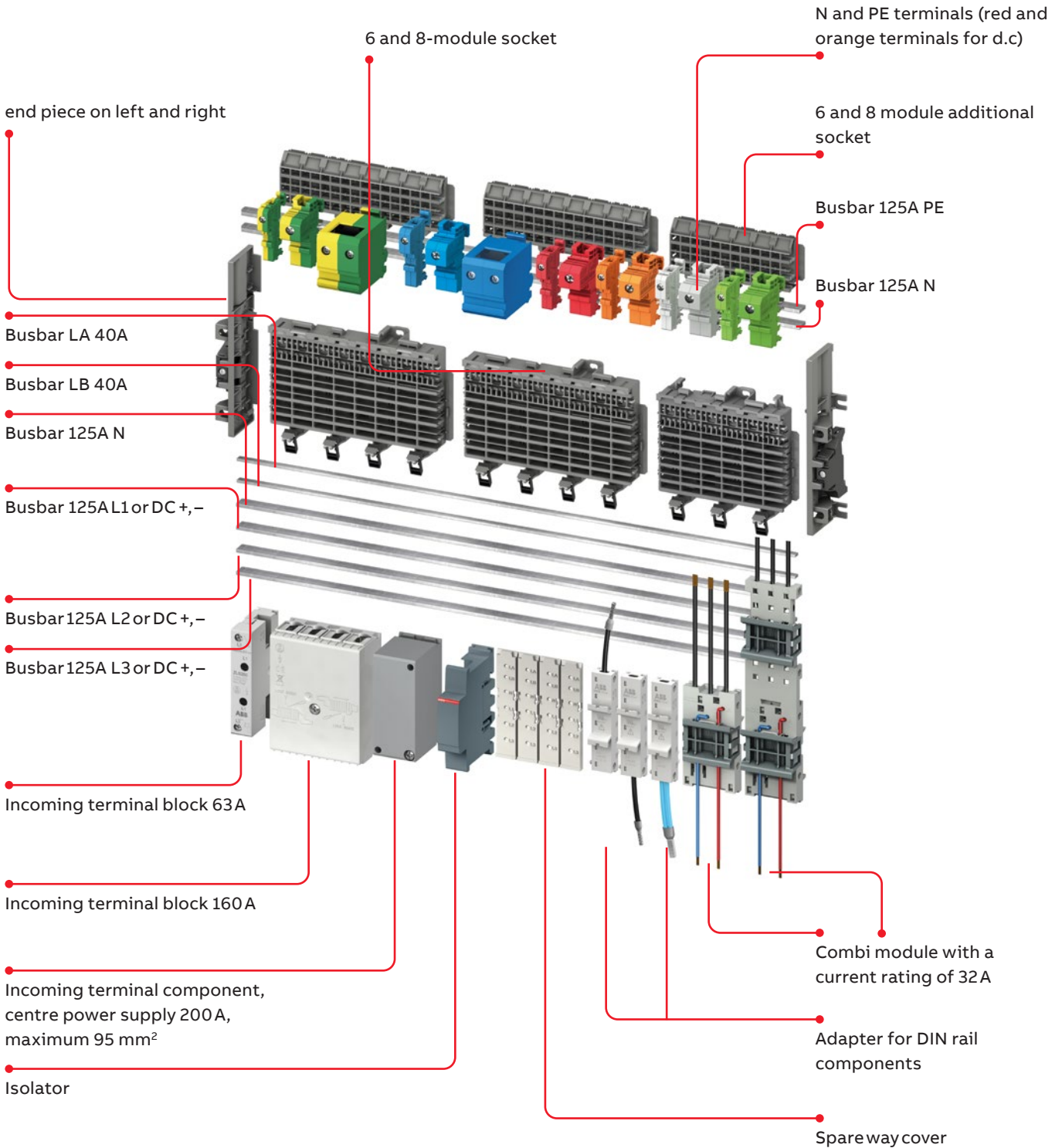

## Technical data IEC/EN 61439-6

### Busbar system 125 A

#### Busbar system touch proof:

Use only for wall mounted application (horizontal or vertical). When installed correctly the requirements of IEC/EN 61439-2 are met.

Number of poles	max. 6 to 110 3p+N / 2 additional bars PE+N
Rated operational voltage ( $U_e$ )	690 VAC, 440 VDC (400V for LA, LB busbars)
Rated insulation voltage ( $U_i$ )	690 VAC, 1000 VDC
IP Code	IP20B
Mounting position	horizontal or vertical, direct mounting or mounting on DIN rail acc. to EN 60715 35 mm
Pollution degree	3 (690V a.c.) 2 (1000V d.c.)
Rated impulse voltage ( $U_{imp}$ )	8 kV Main busbars; 6 kV Auxiliary busbars
Rated current of the assembly ( $I_n$ )	Max. 125 A (side feeding) Max. 200 A (center feeding) Max. 250 A (Double feed side or center)
Auxiliary circuit	max. 40A
Rated current of a circuit ( $I_{nc}$ )	Main circuit: Max. 125A
Rated current of Auxiliary circuit	40A
Rated short-time withstand current ( $I_{cw}$ )	10kA / 300ms
Auxiliary circuit	4 kA / 50ms
Rated peak withstand current ( $I_{pk}$ )	Main circuit: 30kA
Auxiliary circuit	Auxiliary busbars LA, LB 6kA
Rated frequency (f)	50/60Hz, DC
Rated conditional short-circuit current ( $I_{cc}$ )	100kA (415V), 50kA (690V)
Ambient air temperature	max. 60°C
Environmental conditions (damp heat) acc. to IEC/EN 60068-2-30	1 cycle with 55°C/90...96% and 25°C/95...100%
Size of CU bars 3P+N+PE	3x10mm (30mm <sup>2</sup> )
Size of CU auxiliary bars La Lb	2x5 mm (10mm <sup>2</sup> )
Resistance and reactance values Busbar ZLS200	R 0.13mΩ/m X 0.118mΩ/m
Ambient temperature	-25 ... +60 °C
Storage temperature	-40 ... +70 °C

	Maximum rated voltage	Maximum rated current	Cross-section of conductors
Busbar ZLS200	690 VAC 1000 VDC	125 A	
Busbar ZLS202	690 VAC 600 VDC	40 A	
DIN Rail adapters 32 A	690 VAC 600 VDC	32 A Line or neutral	
DIN Rail adapters 63 A	690 VAC 600 VDC	63 A Line or neutral	
Combi module	690 VAC 600 VDC	32 A Line or neutral 6A LA, LB	

The SMISLINE system and components are tested for vibration according to IEC 60068-2-6 (2–13.2 Hz/1 mm displacement, 13.2–100 Hz/0.7 g) and for Miniature circuit breakers (5 g, 20 frequency cycles 5 ...150 ... 5 Hz at 0.8 rated current)

Standard: IEC 60068-2-6

Environmental testing – Part 2–6: Test Fc. Vibration (sinusoidal)

Rated Voltage ( $U_e$ )	Rated conditional short-circuit current ( $I_{cc}$ )	Incoming current of main busbars (L1, L2, L3, N)	Short circuit protection device (SCPD)	
			Fuse	MCCB
415V	100kA	250A	NH1 gG 690V/250A	ABB T <sub>max</sub> XT Serie up to 250A
690V	25kA	250A	NH1 gG 690V/250A	ABB T <sub>max</sub> XT Serie up to 250A
		Incoming current of auxiliary busbars (La, Lb)		
	25kA	40A	NH00 gG 415 V/40A	ABB Type S800 (240/415 VAC)

## Technical data data UL508; Approvals for US and CA: cULus

### Busbar system 125A

SMISSLINE TP system for UL 508 – Industrial Control Equipment, CSA C22.2 No. 14 – Industrial Control Equipment UL File E222110

#### Technical data UL508 Industrial Control Equipment SMISSLINE TP busbar system

Rated Voltage	600 VAC
Rated Current	125 A
Rated Current (End Feed, left and right)	125 A left, 125 A right
Rated Current (Center)	250 A max. (double feed)
Rated Current (Center Feed)	250 A max. if used with two feeder blocks
Short Circuit Ratings	50 kA, max. 480 VAC, 480Y/277 V and 240 VAC or
T <sub>max</sub> XT Serie up to 250A	35 kA, max. 600 VAC and 600 V/347 V

#### Technical data UL508 Industrial Control Equipment (ZLS906,ZLS908,ZLS920,ZLS926,ZLS928)

	Busbar ZLS200	Feeder ZLS924	Feeder block ZLS95X	Combimodule ZLS840X, 842X	DIN Rail adapter ZLS97X	Terminals ZLS95XUL, 91XUL	Combi modul ZMS132X	Adapter moter strater ZMS93X
Maximum rated voltage	600 VAC	600 VAC	600 VAC	600 VAC	600 VAC	600 VAC	600 VAC	600 VAC
Maximum rated current	125 A	150 A	150 A	30 A	32 A, 63 A	32 A, 100 A, 150 A	32 A	32 A

#### Terminals for 125 A SMISSLINE TP System

ZLS954UL – Terminal 150 A (Neutral)  
 ZLS959UL – Terminal (PE)  
 ZLS913UL – Terminal 63 A (Neutral)  
 ZLS918UL – Terminal 32 A (Neutral)  
 ZLS919UL – Terminal (PE)  
 ZLS929UL – Terminal (PE)

#### DIN Rail adapters for MCB SU200 and SUP200

	ZLS970UL, ZLS971UL, ZLS972UL or ZLS973UL
Maximum nominal current	25 A, 45 A

## Starter pack Touch proof 3L

Busbar system 125A

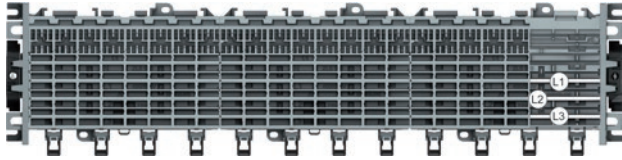

### Starter Pack 3L: L1, L2, L3 inclusive socket end piece

Solutions available	Busbars length incl. Socket end piece mm	Busbars length mm	Type name	ABB IT number	EAN number 761 227	Pack-aging	Weight in grams
18 PLE 3L	364	320	ZLS905E18-3L	2CCA183232R0001	142 6514	1	530
20 PLE 3L	401	357	ZLS905E20-3L	2CCA183100R0001	141 3231	1	637
22 PLE 3L	437	393	ZLS905E22-3L	2CCA183102R0001	141 3255	1	693
24 PLE 3L	473	429	ZLS905E24-3L	2CCA183104R0001	141 3279	1	749
26 PLE 3L	509	465	ZLS905E26-3L	2CCA183106R0001	141 3293	1	813
28 PLE 3L	545	501	ZLS905E28-3L	2CCA183108R0001	141 3415	1	848
30 PLE 3L	581	537	ZLS905E30-3L	2CCA183110R0001	141 3439	1	933
32 PLE 3L	617	573	ZLS905E32-3L	2CCA183112R0001	141 3453	1	981
34 PLE 3L	653	609	ZLS905E34-3L	2CCA183114R0001	141 3477	1	1044
36 PLE 3L	689	645	ZLS905E36-3L	2CCA183116R0001	141 3491	1	1100
38 PLE 3L	725	681	ZLS905E38-3L	2CCA183118R0001	141 3514	1	1156
40 PLE 3L	761	717	ZLS905E40-3L	2CCA183120R0001	141 3538	1	1212
42 PLE 3L	797	753	ZLS905E42-3L	2CCA183122R0001	141 3552	1	1276
44 PLE 3L	833	789	ZLS905E44-3L	2CCA183124R0001	141 3576	1	1332
46 PLE 3L	869	825	ZLS905E46-3L	2CCA183126R0001	141 3590	1	1388
48 PLE 3L	905	861	ZLS905E48-3L	2CCA183128R0001	141 3613	1	1444
50 PLE 3L	941	897	ZLS905E50-3L	2CCA183130R0001	141 3637	1	1508
52 PLE 3L	977	933	ZLS905E52-3L	2CCA183132R0001	141 3651	1	1564
54 PLE 3L	1013	969	ZLS905E54-3L	2CCA183134R0001	141 3675	1	1620
56 PLE 3L	1049	1005	ZLS905E56-3L	2CCA183136R0001	141 3699	1	1675
58 PLE 3L	1058	1041	ZLS905E58-3L	2CCA183138R0001	141 3712	1	1739
60 PLE 3L	1122	1078	ZLS905E60-3L	2CCA183140R0001	141 3736	1	1795
62 PLE 3L	1158	1114	ZLS905E62-3L	2CCA183142R0001	141 3750	1	1851
64 PLE 3L	1194	1150	ZLS905E64-3L	2CCA183144R0001	141 3774	1	1907
66 PLE 3L	1230	1186	ZLS905E66-3L	2CCA183146R0001	141 3798	1	1971
68 PLE 3L	1266	1222	ZLS905E68-3L	2CCA183148R0001	141 3811	1	2027
70 PLE 3L	1302	1258	ZLS905E70-3L	2CCA183150R0001	141 3835	1	2083
72 PLE 3L	1338	1294	ZLS905E72-3L	2CCA183152R0001	141 3859	1	2139
74 PLE 3L	1374	1330	ZLS905E74-3L	2CCA183154R0001	141 3873	1	2203
76 PLE 3L	1410	1366	ZLS905E76-3L	2CCA183156R0001	141 3897	1	2269
78 PLE 3L	1446	1402	ZLS905E78-3L	2CCA183158R0001	141 3910	1	2314
80 PLE 3L	1482	1438	ZLS905E80-3L	2CCA183160R0001	141 3934	1	2370

## Starter pack Touch proof 3LN

Busbar system 125A

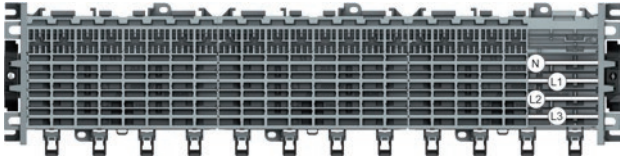

Starter Pack 3LN: L1, L2, L3, N inclusive socket end piece

Solutions available	Busbars length incl. Socket end piece mm	Busbars length mm	Type name	ABB IT number	EAN number 761 227	Pack-aging	Weight in grams
18 PLE 3LN	364	320	ZLS905E18-3LN	2CCA183234R0001	142 6521	1	615
20 PLE 3LN	401	357	ZLS905E20-3LN	2CCA183101R0001	141 3248	1	724
22 PLE 3LN	437	393	ZLS905E22-3LN	2CCA183103R0001	141 3262	1	789
24 PLE 3LN	473	429	ZLS905E24-3LN	2CCA183105R0001	141 3286	1	800
26 PLE 3LN	509	465	ZLS905E26-3LN	2CCA183107R0001	141 3408	1	926
28 PLE 3LN	545	501	ZLS905E28-3LN	2CCA183109R0001	141 3422	1	970
30 PLE 3LN	581	537	ZLS905E30-3LN	2CCA183111R0001	141 3446	1	1046
32 PLE 3LN	617	573	ZLS905E32-3LN	2CCA183113R0001	141 3460	1	1120
34 PLE 3LN	653	609	ZLS905E34-3LN	2CCA183115R0001	141 3484	1	1193
36 PLE 3LN	689	645	ZLS905E36-3LN	2CCA183117R0001	141 3507	1	1257
38 PLE 3LN	725	681	ZLS905E38-3LN	2CCA183119R0001	141 3521	1	1322
40 PLE 3LN	761	717	ZLS905E40-3LN	2CCA183121R0001	141 3545	1	1387
42 PLE 3LN	797	753	ZLS905E42-3LN	2CCA183123R0001	141 3569	1	1459
44 PLE 3LN	833	789	ZLS905E44-3LN	2CCA183125R0001	141 3583	1	1524
46 PLE 3LN	869	825	ZLS905E46-3LN	2CCA183127R0001	141 3606	1	1589
48 PLE 3LN	905	861	ZLS905E48-3LN	2CCA183129R0001	141 3620	1	1653
50 PLE 3LN	941	897	ZLS905E50-3LN	2CCA183131R0001	141 3644	1	1726
52 PLE 3LN	977	933	ZLS905E52-3LN	2CCA183133R0001	141 3668	1	1791
54 PLE 3LN	1013	969	ZLS905E54-3LN	2CCA183135R0001	141 3682	1	1855
56 PLE 3LN	1049	1005	ZLS905E56-3LN	2CCA183137R0001	141 3705	1	1920
58 PLE 3LN	1058	1041	ZLS905E58-3LN	2CCA183139R0001	141 3729	1	1992
60 PLE 3LN	1122	1078	ZLS905E60-3LN	2CCA183141R0001	141 3743	1	2057
62 PLE 3LN	1158	1114	ZLS905E62-3LN	2CCA183143R0001	141 3767	1	2122
64 PLE 3LN	1194	1150	ZLS905E64-3LN	2CCA183145R0001	141 3781	1	2186
66 PLE 3LN	1230	1186	ZLS905E66-3LN	2CCA183147R0001	141 3804	1	2259
68 PLE 3LN	1266	1222	ZLS905E68-3LN	2CCA183149R0001	141 3828	1	2324
70 PLE 3LN	1302	1258	ZLS905E70-3LN	2CCA183151R0001	141 3842	1	2388
72 PLE 3LN	1338	1294	ZLS905E72-3LN	2CCA183153R0001	141 3866	1	2453
74 PLE 3LN	1374	1330	ZLS905E74-3LN	2CCA183155R0001	141 3880	1	2526
76 PLE 3LN	1410	1366	ZLS905E76-3LN	2CCA183157R0001	141 3903	1	2590
78 PLE 3LN	1446	1402	ZLS905E78-3LN	2CCA183159R0001	141 3927	1	2655
80 PLE 3LN	1482	1438	ZLS905E80-3LN	2CCA183161R0001	141 3941	1	2719

## Starter pack Touch proof 3L LA LB

Busbar system 125A

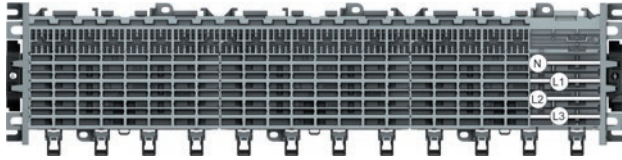

Starter Pack 3LLALB: L1, L2, L3, LA, LB inclusive socket end piece

Solutions available	Busbars length incl. Socket end piece mm	Busbars length mm	Type name	ABB IT number	EAN number 761 227	Pack-aging	Weight in grams
18 PLE 3L LA LB	364	320	ZLS905E18-3LLALB	2CCA183233R0001	142 6538	1	586
20 PLE 3L LA LB	401	357	ZLS905E20-3LLALB	2CCA183162R0001	141 6904	1	753
22 PLE 3L LA LB	437	393	ZLS905E22-3LLALB	2CCA183164R0001	141 6911	1	821
24 PLE 3L LA LB	473	429	ZLS905E24-3LLALB	2CCA183166R0001	141 6928	1	835
26 PLE 3L LA LB	509	465	ZLS905E26-3LLALB	2CCA183168R0001	141 6935	1	964
28 PLE 3L LA LB	545	501	ZLS905E28-3LLALB	2CCA183170R0001	141 6942	1	1011
30 PLE 3L LA LB	581	537	ZLS905E30-3LLALB	2CCA183172R0001	141 6959	1	1107
32 PLE 3L LA LB	617	573	ZLS905E32-3LLALB	2CCA183174R0001	141 6966	1	1167
34 PLE 3L LA LB	653	609	ZLS905E34-3LLALB	2CCA183176R0001	141 6973	1	1242
36 PLE 3L LA LB	689	645	ZLS905E36-3LLALB	2CCA183178R0001	141 6980	1	1310
38 PLE 3L LA LB	725	681	ZLS905E38-3LLALB	2CCA183180R0001	141 6997	1	1377
40 PLE 3L LA LB	761	717	ZLS905E40-3LLALB	2CCA183182R0001	141 7000	1	1445
42 PLE 3L LA LB	797	753	ZLS905E42-3LLALB	2CCA183184R0001	141 7017	1	1520
44 PLE 3L LA LB	833	789	ZLS905E44-3LLALB	2CCA183186R0001	141 7024	1	1588
46 PLE 3L LA LB	869	825	ZLS905E46-3LLALB	2CCA183188R0001	141 7031	1	1656
48 PLE 3L LA LB	905	861	ZLS905E48-3LLALB	2CCA183190R0001	141 7048	1	1723
50 PLE 3L LA LB	941	897	ZLS905E50-3LLALB	2CCA183192R0001	141 7055	1	1799
52 PLE 3L LA LB	977	933	ZLS905E52-3LLALB	2CCA183194R0001	141 7062	1	1866
54 PLE 3L LA LB	1013	969	ZLS905E54-3LLALB	2CCA183196R0001	141 7079	1	1934
56 PLE 3L LA LB	1049	1005	ZLS905E56-3LLALB	2CCA183198R0001	141 7086	1	2001
58 PLE 3L LA LB	1085	1041	ZLS905E58-3LLALB	2CCA183200R0001	141 7093	1	2077
60 PLE 3L LA LB	1122	1078	ZLS905E60-3LLALB	2CCA183202R0001	141 7109	1	2144
62 PLE 3L LA LB	1158	1114	ZLS905E62-3LLALB	2CCA183204R0001	141 7116	1	2212
64 PLE 3L LA LB	1194	1150	ZLS905E64-3LLALB	2CCA183206R0001	141 7123	1	2279
66 PLE 3L LA LB	1230	1186	ZLS905E66-3LLALB	2CCA183208R0001	141 7130	1	2355
68 PLE 3L LA LB	1266	1222	ZLS905E68-3LLALB	2CCA183210R0001	141 7147	1	2423
70 PLE 3L LA LB	1302	1258	ZLS905E70-3LLALB	2CCA183212R0001	141 7154	1	2490
72 PLE 3L LA LB	1338	1294	ZLS905E72-3LLALB	2CCA183214R0001	141 7161	1	2558
74 PLE 3L LA LB	1374	1330	ZLS905E74-3LLALB	2CCA183216R0001	141 7178	1	2633
76 PLE 3L LA LB	1410	1366	ZLS905E76-3LLALB	2CCA183218R0001	141 7185	1	2701
78 PLE 3L LA LB	1446	1402	ZLS905E78-3LLALB	2CCA183220R0001	141 7192	1	2768
80 PLE 3L LA LB	1482	1438	ZLS905E80-3LLALB	2CCA183222R0001	141 7208	1	2836



## Starter pack Touch proof 3LN LA LB

Busbar system 125A

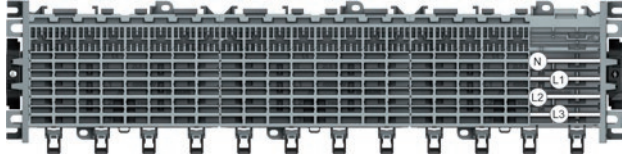



Starter Pack 3LNLALB: L1, L2, L3, N, LA, LB inclusive socket end piece

Solutions available	Busbars length incl. Socket end piece mm	Busbars length mm	Type name	ABB IT number	EAN number 761 227	Pack-aging	Weight in grams
18 PLE 3LN LA LB	364	320	ZLS905E18-3LNLALB	2CCA183235R0001	142 6545	1	671
20 PLE 3LN LA LB	401	357	ZLS905E20-3LNLALB	2CCA183163R0001	141 7215	1	841
22 PLE 3LN LA LB	437	393	ZLS905E22-3LNLALB	2CCA183165R0001	141 7222	1	917
24 PLE 3LN LA LB	473	429	ZLS905E24-3LNLALB	2CCA183167R0001	141 7239	1	939
26 PLE 3LN LA LB	509	465	ZLS905E26-3LNLALB	2CCA183169R0001	141 7246	1	1078
28 PLE 3LN LA LB	545	501	ZLS905E28-3LNLALB	2CCA183171R0001	141 7253	1	1133
30 PLE 3LN LA LB	581	537	ZLS905E30-3LNLALB	2CCA183173R0001	141 7260	1	1238
32 PLE 3LN LA LB	617	573	ZLS905E32-3LNLALB	2CCA183175R0001	141 7277	1	1306
34 PLE 3LN LA LB	653	609	ZLS905E34-3LNLALB	2CCA183177R0001	141 7284	1	1391
36 PLE 3LN LA LB	689	645	ZLS905E36-3LNLALB	2CCA183179R0001	141 7291	1	1467
38 PLE 3LN LA LB	725	681	ZLS905E38-3LNLALB	2CCA183181R0001	141 7307	1	1543
40 PLE 3LN LA LB	761	717	ZLS905E40-3LNLALB	2CCA183183R0001	141 7314	1	1619
42 PLE 3LN LA LB	797	753	ZLS905E42-3LNLALB	2CCA183185R0001	141 7321	1	1704
44 PLE 3LN LA LB	833	789	ZLS905E44-3LNLALB	2CCA183187R0001	141 7338	1	1780
46 PLE 3LN LA LB	869	825	ZLS905E46-3LNLALB	2CCA183189R0001	141 7345	1	1856
48 PLE 3LN LA LB	905	861	ZLS905E48-3LNLALB	2CCA183191R0001	141 7352	1	1933
50 PLE 3LN LA LB	941	897	ZLS905E50-3LNLALB	2CCA183193R0001	141 7369	1	2017
52 PLE 3LN LA LB	977	933	ZLS905E52-3LNLALB	2CCA183195R0001	141 7376	1	2093
54 PLE 3LN LA LB	1013	969	ZLS905E54-3LNLALB	2CCA183197R0001	141 7383	1	2169
56 PLE 3LN LA LB	1049	1005	ZLS905E56-3LNLALB	2CCA183199R0001	141 7390	1	2246
58 PLE 3LN LA LB	1058	1041	ZLS905E58-3LNLALB	2CCA183201R0001	141 7406	1	2330
60 PLE 3LN LA LB	1122	1078	ZLS905E60-3LNLALB	2CCA183203R0001	141 7413	1	2406
62 PLE 3LN LA LB	1158	1114	ZLS905E62-3LNLALB	2CCA183205R0001	141 7505	1	2482
64 PLE 3LN LA LB	1194	1150	ZLS905E64-3LNLALB	2CCA183207R0001	141 9172	1	2559
66 PLE 3LN LA LB	1230	1186	ZLS905E66-3LNLALB	2CCA183209R0001	141 7420	1	2643
68 PLE 3LN LA LB	1266	1222	ZLS905E68-3LNLALB	2CCA183211R0001	141 7437	1	2719
70 PLE 3LN LA LB	1302	1258	ZLS905E70-3LNLALB	2CCA183213R0001	141 7444	1	2796
72 PLE 3LN LA LB	1338	1294	ZLS905E72-3LNLALB	2CCA183215R0001	141 7451	1	2872
74 PLE 3LN LA LB	1374	1330	ZLS905E74-3LNLALB	2CCA183217R0001	141 7468	1	2956
76 PLE 3LN LA LB	1410	1366	ZLS905E76-3LNLALB	2CCA183219R0001	141 7475	1	3032
78 PLE 3LN LA LB	1446	1402	ZLS905E78-3LNLALB	2CCA183221R0001	141 7482	1	3109
80 PLE 3LN LA LB	1482	1438	ZLS905E80-3LNLALB	2CCA183223R0001	141 7499	1	3185

## Sockets Touch proof

### Busbar system 125A

#### Socket base

	Description	Type name	ABB IT number	EAN number 761 227	Pack unit	Moduls (1 PLE 18mm)	Weight in grams
	8-module socket Length 144 mm (includes base and cover)	ZLS908	2CCA183030R0001	141 3965	10	8	92
	6-module socket Length 108 mm (includes base and cover)	ZLS906	2CCA183035R0001	141 3958	10	6	71
							

#### Busbars for the sockets

	Description	Type name	ABB IT number	EAN number 761 227	Packaging unit	Module	Weight in grams
	125A busbar plated, 10x3 mm, for L1, L2, L3, N and PE – Delivery length 1979 mm	ZLS200	2CCF002772R0001	001 5702	10	110	640
	40A auxiliary busbar plated, 5x2 mm, for LA und LB – Delivery length 1979 mm	ZLS202	2CCF002773R0001	001 5719	10	110	240

#### Socket end piece

	Description	Type name	ABB IT number	EAN number 761 227	Packaging unit	Module	Weight in grams
	To prevent displacement of sockets and busbars	ZLS920	2CCA183017R0001	141 5617	1	2 pieces, 60 left and right	

## Additional socket touch proof

### Busbar system 125 A

#### Additional socket

The additional socket can easily be fitted onto the socket base to accommodate the external N and/or PE busbars. This enables neutral connections to be made where single-pole miniature circuit breakers are used with unswitched neutral.

Neutral terminals are clipped onto the additional socket and can be used as detachable neutral connections. One N busbar and/or one PE busbar can be fitted. Each socket base can be equipped with an additional socket.

#### Additional socket for external N and PE busbars

	Type name	ABB IT number	EAN number 761 227	Pack- aging unit	Module	Weight in grams	
	- 8-module socket (suitable for 8-module socket)	ZLS928	2CCA183630R0001	142 0444	10	8	34
	- 6-module socket (suitable for 6-module socket)	ZLS926	2CCA183635R0001	142 0437	10	6	26



## Incoming devices and terminals

Technical data IEC/EN 61439-6 and UL508

### Incoming blocks

	ZLS26X	ZLS924	ZLS25X,95X
<b>General data</b>			
Standards	IEC/EN 61439-6	IEC/EN 61439-6, UL508	IEC/EN 61439-6, UL508
Rated voltage $U_e$ acc. IEC	690 VAC, 1000 VDC	690 VAC, 1000 VDC	690 VAC, 1000 VDC
Rated Voltage acc. UL		600 VAC	600 VAC
Rated current $I_n$ acc. IEC	63 A	160 A	200 A
Rated current $I_n$ acc. UL		150 A	200 A
Rated conditional short-circuit current ( $I_{cc}$ )	100 kA (415V), 50 kA (690 V)	100 kA (415V), 50 kA (690 V)	100 kA (415V), 50 kA (690 V)
<b>Installation</b>			
Terminal rigid IEC connections (solid/stranded)	2,5 mm <sup>2</sup> to 25 mm <sup>2</sup> max. 1 wire	10 mm <sup>2</sup> up to 50 mm <sup>2</sup> (3LN) 1.5 mm <sup>2</sup> up to 10 mm <sup>2</sup> (LA, LB) Multiple 3LN: – Multiple LA, LB: –	10 mm <sup>2</sup> to 95 mm <sup>2</sup>
Terminal flexible IEC connections	2,5 mm <sup>2</sup> to 25 mm <sup>2</sup> max. 1 wire flexible wire with ferrules	10 mm <sup>2</sup> up to 50 mm <sup>2</sup> single wire 1.5 mm <sup>2</sup> up to 10 mm <sup>2</sup> (LA, LB) single wire 2 x 25 mm <sup>2</sup> cable with the same type and size Multiple LA, LB: –	10 mm <sup>2</sup> to 95 mm <sup>2</sup> flexible wire with ferrules
Other connections		Flat cable 9 x 2 x 0,8 up to 9 x 9 x 0,8 mm and 10 x 3 mm Busbar 10 x 3 mm combined with 10 mm <sup>2</sup> up to 25 mm <sup>2</sup> rigid or flexible IEC connections	10 mm <sup>2</sup> to 95 mm <sup>2</sup>
Terminal rigid UL connections		Single: 8 up to 1/0 AWG, Cu only Multiple: –	2 AWG – 1/0 AWG
Torque	2.8 Nm	4.0 Nm (L,N); 1.5 Nm (LA, LB); 1.2 Nm Cover screw	2.0 Nm
Stripping length	13 mm	18 mm (L,N); 11 Nm (LA, LB)	21 mm

## Incoming terminal block

The 63 A and 160 A Incoming terminal block can be used for the 125 A or the 250 A system.



	Type name	ABB IT number	EAN number 761 227	Pack-aging unit	Module	Weight in grams
	L1, L3 63A	ZLS260	2CCA205305R0001	011 1572	1	90
	L2, N 63A	ZLS261	2CCA205306R0001	011 1589	1	90
	LA, LB 6A	ZLS262	2CCA205307R0001	011 1596	1	90

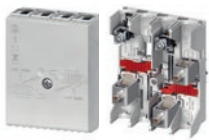

	Type name	ABB IT number	EAN number 761 227	Pack-aging unit	Module	Weight in grams	
	Incoming terminal block incl. cover						
	3L left	ZLS924-3L	2CCF181816R0001	150 3086	1	4	140
	3L+N left	ZLS924-3LN	2CCF181818R0001	150 3093	1	4	168
	3L+N+LA+LB left	ZLS924-3LNAB	2CCF181820R0001	150 3109	1	4	188
	3L right	ZLS924-3L-R	2CCF181817R0001	150 3116	1	4	140
	3L+N right	ZLS924-3LN-R	2CCF181819R0001	150 3123	1	4	168
	3L+N+LA+LB right	ZLS924-3LNAB-R	2CCF181821R0001	150 3130	1	4	188

ZLS924 right version

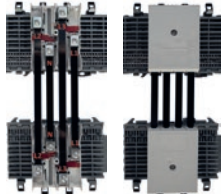

ZLS924 left version



terminals of the left and right version of the Incoming block are turned. Because of this there is no cable cross by connecting two SMISSLINE rows (see picture)

### Terminals for incoming block



	Type name	ABB IT number	EAN number 761 227	Pack-aging unit	Module	Weight in grams
	Terminal L	ZLS936	2CCF181805R0001	150 3147	1	28
	Terminal LA LB	ZLS937	2CCF181807R0001	150 3154	1	10

### Cover for incoming terminal block



	Type name	ABB IT number	EAN number 761 227	Pack-aging unit	Module	Weight in grams	
	Cover for ZLS924	ZLS939	2CCF181812R0001	150 3161	1	4	26

## Incoming components

Technical data IEC/EN 61439-6 and UL508

The 200 A incoming terminal component is available as a single-pole. It can be used for the 125 A or the 250 A system.

Version	Type name	ABB IT number	EAN number 761 227	Pack- aging unit	Module	Weight in grams	
	Feeder component L1	ZLS251	2CCV672501R0001	050 5319	1	2	120
	Feeder component L2	ZLS252	2CCV672502R0001	050 5326	1	2	120
	Feeder component L3	ZLS253	2CCV672503R0001	050 5333	1	2	120
	Feeder component N	ZLS250	2CCV672500R0001	050 5340	1	2	120
	Feeder component N additional socket	ZLS954	2CCV672508R0001	142 4404	1	2	100
	Feeder component PE additional socket	ZLS959	2CCA672510R0001	148 7164	1	2	100
	Feeder component N additional socket (2 holes)	ZLS954-1	2CCG001032R0001	151 5348	1	2	88

### Cover for feeder component

Type name	ABB IT number	EAN number 761 227	Pack- aging unit	Module	Weight in grams		
	Cover for ZLS250...253	ZLS25D	2CCA183483R0001	150 1419	1	2	23

## Terminals for additional socket

Technical data IEC/EN 61439-6 and UL508

### Terminals

	10 mm <sup>2</sup> IEC ZLS918, ZLS919	AWG3/0 ZLS918UL, ZLS919UL	35 mm <sup>2</sup> IEC ZLS913, ZLS916, ZLS929	AWG2 ZLS913UL, ZLS929UL	95 mm <sup>2</sup> IEC ZLS954, ZLS959	AWG8 ZLS954UL, ZLS959UL
<b>General data</b>						
Standards	IEC/EN 61439-6	UL 508 CSA C22.2 No. 14-13	IEC/EN 61439-6	UL 508 CSA C22.2 No. 14-13	IEC/EN 61439-6	UL 508 CSA C22.2 No. 14-13
Rated voltage U <sub>e</sub> acc. IEC	690 VAC, 1000 VDC	–	690 VAC, 1000 VDC	–	690 VAC, 1000 VDC	–
Rated voltage acc. UL –	–	600 VAC	–	600 VAC	–	600 VAC
Rated current I <sub>n</sub> acc. IEC	32 A	–	63 A	–	200 A	–
Rated current acc. UL –	–	32 A	–	63 A	–	150 A
Rated conditional short-circuit current (I <sub>cc</sub> )	100 kA (415V), 50 kA (690 V)	100 kA (415V), 50 kA (690 V)	100 kA (415V), 50 kA (690 V)	100 kA (415V), 50 kA (690 V)	100 kA (415V), 50 kA (690 V)	100 kA (415V), 50 kA (690 V)
<b>Installation</b>						
Terminal rigid IEC connections (solid/stranded)	Single: 1 ... 10 mm <sup>2</sup> Multiple: 2 x 1.5 ... 2.5 mm <sup>2</sup> , with cables of same type and size	–	–	–	–	–
Terminal flexible IEC connections	Single: 0.7 ... 10 mm <sup>2</sup> Multiple: 2 x 1.5 ... 2.5 mm <sup>2</sup> , with cables of same type and size	–	Single: 16 ... 35 mm <sup>2</sup> Multiple: –	–	Single: 10 ... 95 mm <sup>2</sup> Multiple: 2 x 10 ... 25 mm <sup>2</sup> , with cables of same type and size	–
Terminal UL connections	–	Single: 14 ... 8 AWG Multiple: –	–	Single: 6 ... 2 AWG Multiple: –	–	Single: 2 ... 1/0 AWG Multiple: –
Torque	1.2 Nm	1.2 Nm	2.5 Nm	2.5 Nm	2.0 Nm	2.0 Nm
Stripping length:	12 mm	12 mm	15 mm	15 mm	21 mm	21 mm

## Terminal range IEC for additional socket

For 125 A system (use on ZLS926/928 or 250 A system ZLSP926/928)

### N terminals and PE terminals

Corresponding N terminals (blue) or PE terminals (yellow-green) are available for the power supply and the outgoing conductors of the external N and PE busbars for cross sections. The terminals are fitted with label holders which can be used with the marking adapter or the marking label (Phoenix Contact type Clipline UC-TM).

#### N terminal for additional socket light blue, for external busbars

	Type name	ABB IT number	EAN number 761 227	Pack- aging unit	Module	Weight in grams	
	N 10 mm <sup>2</sup>	ZLS918	2CCA183440R0001	148 7027	Set of 10	0.5	11
	N 35 mm <sup>2</sup>	ZLS913	2CCA183470R0001	142 1304	1	1	30
	N 95 mm <sup>2</sup>	ZLS954	2CCV672508R0001	142 4404	1	2	100
	N 95 mm <sup>2</sup> two holes	ZLS954-1	2CCG001032R0001	151 5348	1	2	100



#### PE terminal for additional socket yellow-green, for external busbars

	PE 10 mm <sup>2</sup>	ZLS919	2CCA183441R0001	148 7041	Set of 10	0.5	11
	PE 35 mm <sup>2</sup>	ZLS929	2CCA183387R0001	148 6921	1	1	30
	PE 95 mm <sup>2</sup>	ZLS959	2CCA672510R0001	148 7164	1	2	100

#### Red/orange terminals for additional socket

	10 mm <sup>2</sup>	ZLS918/Red	2CCA183443R0001	148 7089	1	0.5	11
	10 mm <sup>2</sup>	ZLS919/Orange	2CCA183444R0001	148 7102	1	0.5	11
	10 mm <sup>2</sup>	ZLS918/Black	2CCA183445R0001	148 7126	1	0.5	11
	35 mm <sup>2</sup>	ZLS913/Red	2CCA183465R0001	142 1342	1	1	30
	35 mm <sup>2</sup>	ZLS916/Orange	2CCA183466R0001	142 1366	1	1	30

### Insulator block

The dark grey insulator block isolates the interrupted bus bar ends from one another and simultaneously marks the disconnection point externally.

#### Insulator block for additional socket

	Type name	ABB IT number	EAN number 761 227	Pack- aging unit	Module	Weight in grams	
	dark gray, to isolate the N bus bar on the additional socket	ZLS927	2CCA183442R0001	148 7065	1	0.5	9



## Terminal range UL for additional socket

For the 125A system (use on ZLS926/928)

The 250A additional (ZLSP926 and ZLSP928) socket has no UL approbation.

The use for this terminals is only for the 125A system.

### N terminal for additional socket light grey, for external busbars

	Type name	ABB IT number	EAN number 761 227	Pack- aging unit	Module	Weight in grams	
	AWG8	ZLS918UL	2CCA183446R0001	149 3301	1	0.5	11
	AWG2	ZLS913UL	2CCA183398R0001	148 6945	1	1	30
	AWG3/0	ZLS954UL	2CCA672511R0001	148 7188	1	2	88

### PE terminal for additional socket grey-green, for external busbars

	AWG8	ZLS919UL	2CCA183447R0001	148 7140	1	0.5	11
	AWG2	ZLS929UL	2CCA183399R0001	148 6969	1	1	30
	AWG3/0	ZLS959UL	2CCA672512R0001	148 7201	1	2	88

### Insulator block

The dark grey insulator block isolates the interrupted bus bar ends from one another and simultaneously marks the disconnection point externally.

### Insulator block for additional socket

	Type name	ABB IT number	EAN number 761 227	Pack- aging unit	Module	Weight in grams	
	dark gray, to isolate the N bus bar on the additional socket	ZLS927	2CCA183442R0001	148 7065	1	0.5	9

## Socket accessories

Accessory can be used on the 125 A or on the 250 A busbar system.

### Intermediate piece

	Type name	ABB IT number	EAN number 761 227	Pack- aging unit	Module	Weight in grams
	light grey, fills shock-proof empty module spaces 18 mm – bag containing 5 items	ZLS725	2CCS500900R0181	010 0989	1	100
	Compensation piece to 18 mm for NT 9 mm – bag containing 5 items	ZLS728	2CCS400900R0101	010 4710	1	70

### Busbar insulator

	dark grey for isolation and spacing of separate busbar sections, 18 mm	ZLS938	2CCA205611R0001	141 8205	1	1
--	---	--------	-----------------	----------	---	---

### Busbar cover

	electrically protected covering of main and auxiliary busbars. The 4 modules cover can be divided. Suitable to accept extension adapter ZLS 101 4x18 mm – bag containing 5 items	ZLS100	2CCF002762R0001	001 5603	1	95
---	---	--------	-----------------	----------	---	----

### Add-on adapter

	18 mm wide, can be plugged on busbar cover ZLS100. To mount conventional DIN devices with 45 mm cap size. – bag containing 10 items	ZLS101	2CCF002763R0001	001 5610	10	2
---	---	--------	-----------------	----------	----	---

### Mounting rail adapter

	Height compensation 22.5 mm, to equalize the installation depth of standard DIN-rail mounted devices alongside the SMISLINE plug-in system.	ZLS741	2CCA180081R0001	001 9632	10	3
---	---	--------	-----------------	----------	----	---

### Locking device for S400, SUP400, F402, F404, FS401, FS403

	Padlock adapter 3 mm – Bag containing 10 items	SA 1	GJF1101903R0001	010 4833	1	–	23
	Padlock set. Locking devices with 2 keys	SA 2	GJF1101903R0002	010 4857	1	–	20

## Busbars 40A and 125A

### 40A and 125A busbars / selection table for sockets

Order data busbar 125A	ABB IT number	EAN number 761 227	ZLS908	ZLS906	Module	Length incl. end piece	Busbar length in mm	Order date busbar 40A	ABB IT number	EAN number 761 227
ZLS201E6	2CCF800158R0001	001 6778	-	1	6	148	103	ZLS203E6	2CCF800218R0001	001 7966
ZLS201E8	2CCF800159R0001	001 6983	1	-	8	186	139	ZLS203E8	2CCF800219R0001	001 8178
ZLS201E12	2CCF800160R0001	001 6211	-	2	12	256	211	ZLS203E12	2CCF800220R0001	001 7409
ZLS201E14	2CCF800161R0001	001 6310	1	1	14	292	247	ZLS203E14	2CCF800221R0001	001 7508
ZLS201E16	2CCF800162R0001	001 6334	2	-	16	328	283	ZLS203E16	2CCF800222R0001	001 7522
ZLS201E18	2CCF800163R0001	001 6358	-	3	18	364	319	ZLS203E18	2CCF800223R0001	001 7546
ZLS201E20	2CCF800164R0001	001 6372	1	2	20	401	355	ZLS203E20	2CCF800224R0001	001 7560
ZLS201E22	2CCF800165R0001	001 6396	2	1	22	437	391	ZLS203E22	2CCF800225R0001	001 7584
ZLS201E24	2CCF800666R0001	001 6419	3	-	24	473	427	ZLS203E24	2CCF800226R0001	001 7607
ZLS201E26	2CCF800167R0001	001 6433	1	3	26	509	463	ZLS203E26	2CCF800227R0001	001 7621
ZLS201E28	2CCF800168R0001	001 6457	2	2	28	545	499	ZLS203E28	2CCF800228R0001	001 7645
ZLS201E30	2CCF800169R0001	001 6471	3	1	30	581	535	ZLS203E30	2CCF800229R0001	001 7669
ZLS201E32	2CCF800170R0001	001 6495	4	-	32	617	571	ZLS203E32	2CCF800230R0001	001 7683
ZLS201E34	2CCF800171R0001	001 6518	2	3	34	653	607	ZLS203E34	2CCF800231R0001	001 7706
ZLS201E36	2CCF800172R0001	001 6532	3	2	36	689	643	ZLS203E36	2CCF800232R0001	001 7720
ZLS201E38	2CCF800173R0001	001 6556	4	1	38	725	679	ZLS203E38	2CCF800233R0001	001 7744
ZLS201E40	2CCF800174R0001	001 6570	5	-	40	761	715	ZLS203E40	2CCF800234R0001	001 7768
ZLS201E42	2CCF800175R0001	001 6594	3	3	42	797	751	ZLS203E42	2CCF800235R0001	001 7782
ZLS201E44	2CCF800176R0001	001 6617	4	2	44	833	787	ZLS203E44	2CCF800236R0001	001 7805
ZLS201E46	2CCF800177R0001	001 6631	5	1	46	869	823	ZLS203E46	2CCF800237R0001	001 7829
ZLS201E48	2CCF800178R0001	001 6655	6	-	48	905	859	ZLS203E48	2CCF800238R0001	001 7843
ZLS201E50	2CCF800179R0001	001 6679	4	3	50	941	895	ZLS203E50	2CCF800239R0001	001 7867
ZLS201E52	2CCF800180R0001	001 6693	5	2	52	977	932	ZLS203E52	2CCF800240R0001	001 7881
ZLS201E54	2CCF800181R0001	001 6716	6	1	54	1013	968	ZLS203E54	2CCF800241R0001	001 7904
ZLS201E56	2CCF800182R0001	001 6730	7	-	56	1049	1004	ZLS203E56	2CCF800242R0001	001 7928
ZLS201E58	2CCF800183R0001	001 6754	5	3	58	1085	1040	ZLS203E58	2CCF800243R0001	001 7942
ZLS201E60	2CCF800184R0001	001 6785	6	2	60	1122	1076	ZLS203E60	2CCF800244R0001	001 7973
ZLS201E62	2CCF800185R0001	001 6808	7	1	62	1158	1112	ZLS203E62	2CCF800245R0001	001 7997
ZLS201E64	2CCF800186R0001	001 6822	8	-	64	1194	1148	ZLS203E64	2CCF800246R0001	001 8017
ZLS201E66	2CCF800187R0001	001 6846	6	3	66	1230	1184	ZLS203E66	2CCF800247R0001	001 8031
ZLS201E68	2CCF800188R0001	001 6860	7	2	68	1266	1220	ZLS203E68	2CCF800248R0001	001 8055
ZLS201E70	2CCF800189R0001	001 6884	8	1	70	1302	1256	ZLS203E70	2CCF800249R0001	001 8079
ZLS201E72	2CCF800190R0001	001 6907	9	-	72	1338	1292	ZLS203E72	2CCF800250R0001	001 8093
ZLS201E74	2CCF800191R0001	001 6921	7	3	74	1374	1328	ZLS203E74	2CCF800251R0001	001 8116
ZLS201E76	2CCF800192R0001	001 6945	8	2	76	1410	1364	ZLS203E76	2CCF800252R0001	001 8130
ZLS201E78	2CCF800193R0001	001 6969	9	1	78	1446	1400	ZLS203E78	2CCF800253R0001	001 8154
ZLS201E80	2CCF800194R0001	001 6990	10	-	80	1482	1436	ZLS203E80	2CCF800254R0001	001 8185
ZLS201E82	2CCF800195R0001	001 7010	8	3	82	1518	1472	ZLS203E82	2CCF800255R0001	001 8208
ZLS201E84	2CCF800196R0001	001 7034	9	2	84	1554	1508	ZLS203E84	2CCF800256R0001	001 8222
ZLS201E86	2CCF800197R0001	001 7058	10	1	86	1590	1544	ZLS203E86	2CCF800257R0001	001 8246
ZLS201E88	2CCF800198R0001	001 7072	11	-	88	1626	1580	ZLS203E88	2CCF800258R0001	001 8260
ZLS201E90	2CCF800199R0001	001 7096	9	3	90	1662	1616	ZLS203E90	2CCF800259R0001	001 8284
ZLS201E92	2CCF800200R0001	001 7119	10	2	92	1698	1652	ZLS203E92	2CCF800260R0001	001 8307
ZLS201E94	2CCF800201R0001	001 7133	11	1	94	1734	1688	ZLS203E94	2CCF800261R0001	001 8321
ZLS201E96	2CCF800202R0001	001 7157	12	-	96	1770	1724	ZLS203E96	2CCF800262R0001	001 8345
ZLS201E98	2CCF800203R0001	001 7171	10	3	98	1806	1760	ZLS203E98	2CCF800263R0001	001 8369
ZLS201E100	2CCF800204R0001	001 6006	11	2	100	1843	1796	ZLS203E100	2CCF800264R0001	001 7195
ZLS201E102	2CCF800205R0001	001 6020	12	1	102	1879	1832	ZLS203E102	2CCF800265R0001	001 7218
ZLS201E104	2CCF800206R0001	001 6044	13	-	104	1915	1868	ZLS203E104	2CCF800266R0001	001 7232
ZLS201E106	2CCF800207R0001	001 6068	11	3	106	1951	1904	ZLS203E106	2CCF800267R0001	001 7256
ZLS201E108	2CCF800208R0001	001 6082	12	2	108	1987	1940	ZLS203E108	2CCF800268R0001	001 7270

Planning for the incorporation of feeder block and spare places should be taken into account.  
The total lengths given above were calculated taking socket spacings and tolerances into account.  
For this reason, the indicated busbar length is not necessarily a multiple of 18mm (1 Module).



# Table of contents

<b>01. Overview, Technical details</b>	84–86
<b>02. Starter pack Touch proof 250 A</b>	87–89
<b>03. Main socket 250 A</b>	90
<b>04. Additional socket</b>	91
<b>05. Incoming 250 A</b>	92–93
<b>06. Terminals for additional socket</b>	94
<b>07. Busbars 250 A</b>	94
<b>08. Direct Feed (XT4) 250 A</b>	96–98

# Busbar system Power Bar System 250 A

## Overview

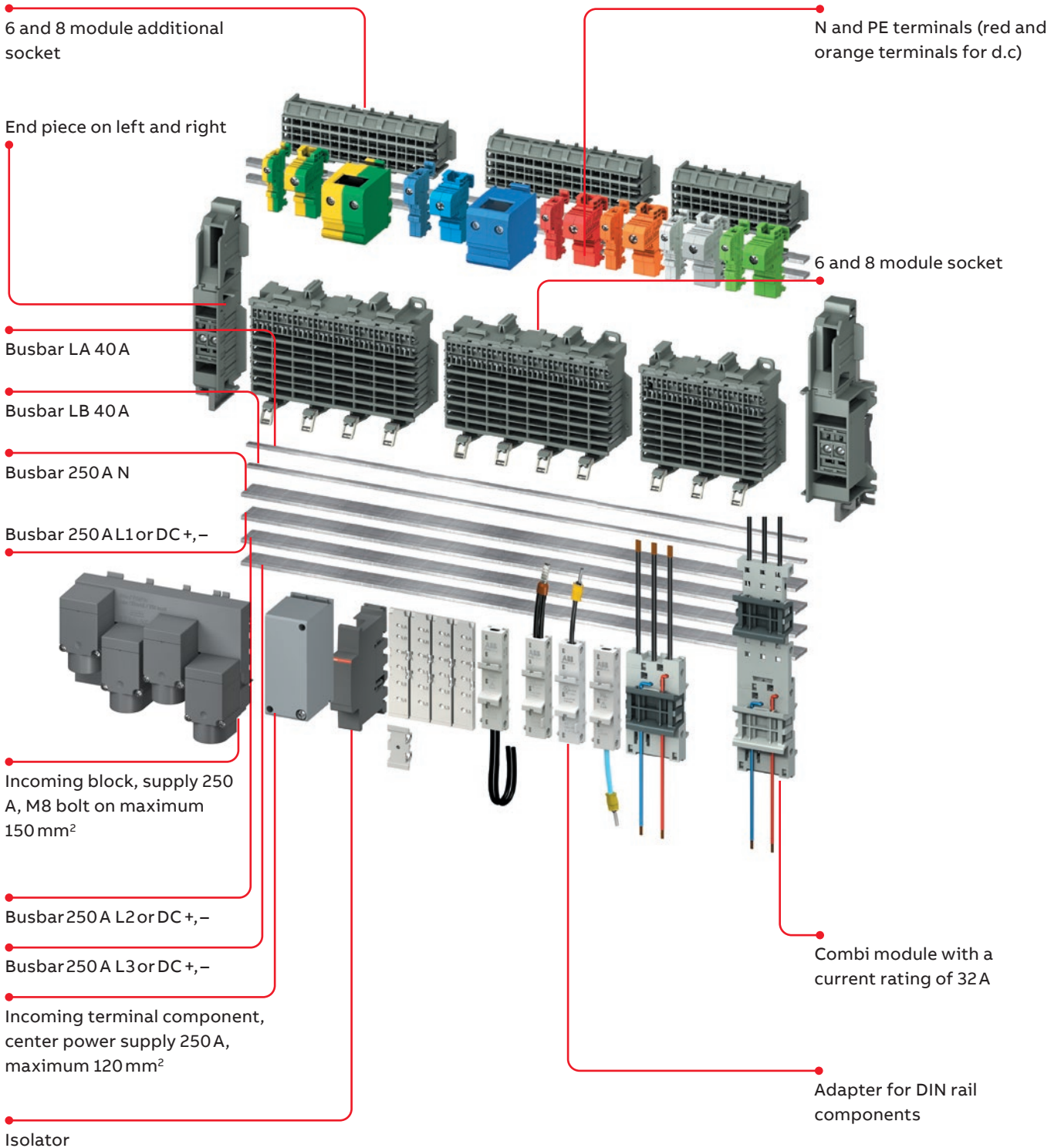

## Technical data according to IEC/EN 61439-6

### Power Bar System 250 A

#### Busbar system touch proof:

Use only for wall mounted application (horizontal or vertical). When installed correctly the requirements of EN/IEC 61439-2 are met.

Number of poles	30 to 110 3P+N / 2 additional bars PE+N
Rated operational voltage (U <sub>e</sub> )	690 VAC, 1000 VDC (400V for LA, LB busbars)
Rated insulation voltage (U <sub>i</sub> ) Main circuit	690 VAC, 440 VDC
Rated insulation voltage (U <sub>i</sub> ) Auxiliary circuit	415 VAC
IP Code	IP20B
Mounting position	horizontal or vertical
Overvoltage category	IV
Pollution degree	3 (690V a.c.) 2 (1000V d.c.)
Rated impulse voltage (U <sub>imp</sub> )	8 kV Main busbars; 6 kV Auxiliary busbars
Rated current of the assembly (I <sub>nA</sub> )	Side feed: 250A, Middle feed 400A, Auxiliary busbars: 40A
Rated current of a circuit (I <sub>nc</sub> )	Main circuit: Max. 100A
Rated current of Auxiliary circuit	40A
Rated short-time withstand current (I <sub>cw</sub> )	15 kA/100ms Main circuit, 4 kA/50ms Auxiliary circuit
Rated peak withstand current Main circuit (I <sub>pk</sub> )	30 kA
Rated peak withstand current Auxiliary circuit (I <sub>pk</sub> )	6 kA
Rated frequency (f)	50/60Hz
Rated conditional short-circuit current (I <sub>cc</sub> )	see table below
Ambient air temperature	max. 60°C
Environmental conditions (damp heat) acc. to IEC/EN 60068-2-30	1 cycle with 55°C/90...96% and 25°C/95...100%
Size of CU bars 3P+N+PE	3x25 mm (75mm <sup>2</sup> )
Size of CU auxiliary bars La Lb	2x5 mm (10mm <sup>2</sup> )
Resistance and reactance values Busbar ZLSP1250	R 0.325mΩ/m X 0.295mΩ/m
Ambient temperature	-25 ... +60 °C
Storage temperature	-40 ... +70 °C

Rated Voltage (U <sub>e</sub> )	Rated conditional short-circuit current (I <sub>cc</sub> )	Incoming current of main busbars (L1, L2, L3, N)	Short circuit protection device (SCPD)	
			Fuse	MCCB
415V	100kA	250A	NH2 gG 690V/250A*	ABB T <sub>max</sub> XT Serie up to 250A*
690V	25kA	250A	NH2 gG 690V/250A	ABB T <sub>max</sub> XT Serie up to 250A*
<b>Incoming current of auxiliary busbars (La, Lb)</b>				
	25kA	40A	NH00 gG 415V/40A	ABB Type S800 (240/415VAC)

\* For 400A Incoming for upstream protection are two fuses or XT breaker necessary or two XT circuit breaker

## Technical data data UL508; Approvals for US and CA: cULus

### Busbar system 250 A

#### SMISLINE TP system for UL 508 – Industrial Control Equipment, CSA C22.2 No. 14 – Industrial Control Equipment UL File E222110

Rated Voltage	600 VAC
Rated Current	250 A left or right
Short Circuit Ratings ABB T <sub>max</sub> XT2, XT4	50 kA, max. 480 VAC, 480Y/277 V and 240 VAC or 35 kA, max. 600 VAC and 600Y/347 V

#### Technical data UL508 Industrial Control Equipment (ZLSP906, ZLSP908, ZLSP920)

	Busbar ZLSP200	Feeder ZLSP934	Feeder block ZLS95X	Combimodule ZLS840X, 842X	DIN Rail adapter ZLS97X	Terminals ZLS95XUL, 91XUL	Combi modul ZMS132X	Adapter moter strater ZMS93X
Maximum rated voltage	600 VAC	600 VAC	600 VAC	600 VAC	600 VAC	600 VAC	600 VAC	600 VAC
Maximum rated current	250 A	250 A	150 A	30 A	32 A, 63 A	32 A, 100 A, 150 A	32 A	32 A

#### DIN rail adapters for MCB SU200 and SUP200

	ZLS970UL, ZLS971UL, ZLS972UL or ZLS973UL
Maximum nominal current	25 A, 45 A

## Starter pack Touch proof 3L

### Power Bar System 250 A

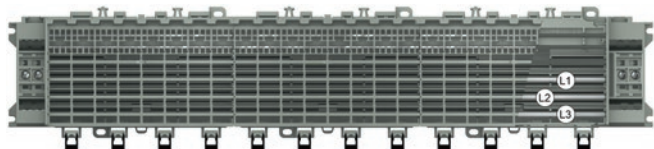

#### Starter Pack 3L: L1, L2, L3 included socket end piece

Solutions available	Busbars length incl. Socket end piece mm	Type name	ABB IT number	EAN number 761 227	Pack unit	Weight in grams
30 modules 3L	607	ZLSP950E30-3L	2CCF212200A0001	1488246	1	1755
32 modules 3L	643	ZLSP950E32-3L	2CCF212201A0001	1488260	1	1863
34 modules 3L	679	ZLSP950E34-3L	2CCF212202A0001	1488284	1	1981
36 modules 3L	715	ZLSP950E36-3L	2CCF212203A0001	1488307	1	2088
38 modules 3L	751	ZLSP950E38-3L	2CCF212204A0001	1488321	1	2195
40 modules 3L	787	ZLSP950E40-3L	2CCF212205A0001	1488345	1	2303
42 modules 3L	823	ZLSP950E42-3L	2CCF212206A0001	1488369	1	2421
44 modules 3L	859	ZLSP950E44-3L	2CCF212207A0001	1488383	1	2528
46 modules 3L	895	ZLSP950E46-3L	2CCF212208A0001	1488406	1	2635
48 modules 3L	931	ZLSP950E48-3L	2CCF212209A0001	1488420	1	2742
50 modules 3L	967	ZLSP950E50-3L	2CCF212210A0001	1488444	1	2861
52 modules 3L	1003	ZLSP950E52-3L	2CCF212211A0001	1488468	1	2968
54 modules 3L	1039	ZLSP950E54-3L	2CCF212212A0001	1488482	1	3075
56 modules 3L	1075	ZLSP950E56-3L	2CCF212213A0001	1488505	1	3182
58 modules 3L	1111	ZLSP950E58-3L	2CCF212214A0001	1488529	1	3301
60 modules 3L	1147	ZLSP950E60-3L	2CCF212215A0001	1488543	1	3408
62 modules 3L	1183	ZLSP950E62-3L	2CCF212216A0001	1488567	1	3515
64 modules 3L	1219	ZLSP950E64-3L	2CCF212217A0001	1488581	1	3622
66 modules 3L	1255	ZLSP950E66-3L	2CCF212218A0001	1488604	1	3741
68 modules 3L	1291	ZLSP950E68-3L	2CCF212219A0001	1488628	1	3848
70 modules 3L	1327	ZLSP950E70-3L	2CCF212220A0001	1488642	1	3955
72 modules 3L	1363	ZLSP950E72-3L	2CCF212221A0001	1488666	1	4062
74 modules 3L	1399	ZLSP950E74-3L	2CCF212222A0001	1488680	1	4180
76 modules 3L	1435	ZLSP950E76-3L	2CCF212223A0001	1488703	1	4288
78 modules 3L	1471	ZLSP950E78-3L	2CCF212224A0001	1488727	1	4395
80 modules 3L	1507	ZLSP950E80-3L	2CCF212225A0001	1488741	1	4502
82 modules 3L	1543	ZLSP950E82-3L	2CCF212226A0001	1488765	1	4620
84 modules 3L	1579	ZLSP950E84-3L	2CCF212227A0001	1488789	1	4728
86 modules 3L	1615	ZLSP950E86-3L	2CCF212228A0001	1488802	1	4835
88 modules 3L	1651	ZLSP950E88-3L	2CCF212229A0001	1488826	1	4942
90 modules 3L	1687	ZLSP950E90-3L	2CCF212230A0001	1488840	1	5060
92 modules 3L	1723	ZLSP950E92-3L	2CCF212231A0001	1488864	1	5167
94 modules 3L	1759	ZLSP950E94-3L	2CCF212232A0001	1488888	1	5275
96 modules 3L	1795	ZLSP950E96-3L	2CCF212233A0001	1488901	1	5382
98 modules 3L	1831	ZLSP950E98-3L	2CCF212234A0001	1488925	1	5500
100 modules 3L	1867	ZLSP950E100-3L	2CCF212235A0001	1488949	1	5607
102 modules 3L	1903	ZLSP950E102-3L	2CCF212236A0001	1488963	1	5715
104 modules 3L	1939	ZLSP950E104-3L	2CCF212237A0001	1488987	1	5822
106 modules 3L	1975	ZLSP950E106-3L	2CCF212238A0001	1489007	1	5940
108 modules 3L	2011	ZLSP950E108-3L	2CCF212239A0001	1489021	1	6047
110 modules 3L	2047	ZLSP950E110-3L	2CCF212240A0001	1489045	1	6121



## Starter pack Touch proof 3LN

### Power Bar System 250 A

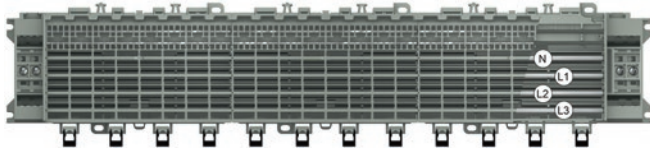

#### Starter Pack 3L: L1, L2, L3 included socket end piece

Solutions available	Busbars length incl. Socket end piece mm	Type name	ABB IT number	EAN number 761 227	Pack unit	Weight in grams
30 modules 3LN	607	ZLSP950E30-3LN	2CCF212300A0001	1489069	1	2122
32 modules 3LN	643	ZLSP950E32-3LN	2CCF212301A0001	1489083	1	2253
34 modules 3LN	679	ZLSP950E34-3LN	2CCF212302A0001	1489106	1	2396
36 modules 3LN	715	ZLSP950E36-3LN	2CCF212303A0001	1489120	1	2527
38 modules 3LN	751	ZLSP950E38-3LN	2CCF212304A0001	1489144	1	2659
40 modules 3LN	787	ZLSP950E40-3LN	2CCF212305A0001	1489168	1	2791
42 modules 3LN	823	ZLSP950E42-3LN	2CCF212306A0001	1489182	1	2933
44 modules 3LN	859	ZLSP950E44-3LN	2CCF212307A0001	1489205	1	3065
46 modules 3LN	895	ZLSP950E46-3LN	2CCF212308A0001	1489229	1	3197
48 modules 3LN	931	ZLSP950E48-3LN	2CCF212309A0001	1489243	1	3328
50 modules 3LN	967	ZLSP950E50-3LN	2CCF212310A0001	1489267	1	3471
52 modules 3LN	1003	ZLSP950E52-3LN	2CCF212311A0001	1489281	1	3603
54 modules 3LN	1039	ZLSP950E54-3LN	2CCF212312A0001	1489304	1	3734
56 modules 3LN	1075	ZLSP950E56-3LN	2CCF212313A0001	1489328	1	3866
58 modules 3LN	1111	ZLSP950E58-3LN	2CCF212314A0001	1489342	1	4008
60 modules 3LN	1147	ZLSP950E60-3LN	2CCF212315A0001	1489366	1	4140
62 modules 3LN	1183	ZLSP950E62-3LN	2CCF212316A0001	1489380	1	4272
64 modules 3LN	1219	ZLSP950E64-3LN	2CCF212317A0001	1489403	1	4403
66 modules 3LN	1255	ZLSP950E66-3LN	2CCF212318A0001	1489427	1	4546
68 modules 3LN	1291	ZLSP950E68-3LN	2CCF212319A0001	1489441	1	4678
70 modules 3LN	1327	ZLSP950E70-3LN	2CCF212320A0001	1489465	1	4809
72 modules 3LN	1363	ZLSP950E72-3LN	2CCF212321A0001	1489489	1	4941
74 modules 3LN	1399	ZLSP950E74-3LN	2CCF212322A0001	1489502	1	5084
76 modules 3LN	1435	ZLSP950E76-3LN	2CCF212323A0001	1489526	1	5215
78 modules 3LN	1471	ZLSP950E78-3LN	2CCF212324A0001	1489540	1	5347
80 modules 3LN	1507	ZLSP950E80-3LN	2CCF212325A0001	1489564	1	5478
82 modules 3LN	1543	ZLSP950E82-3LN	2CCF212326A0001	1489588	1	5621
84 modules 3LN	1579	ZLSP950E84-3LN	2CCF212327A0001	1489601	1	5753
86 modules 3LN	1615	ZLSP950E86-3LN	2CCF212328A0001	1489625	1	5884
88 modules 3LN	1651	ZLSP950E88-3LN	2CCF212329A0001	1489649	1	6016
90 modules 3LN	1687	ZLSP950E90-3LN	2CCF212330A0001	1489663	1	6159
92 modules 3LN	1723	ZLSP950E92-3LN	2CCF212331A0001	1489687	1	6290
94 modules 3LN	1759	ZLSP950E94-3LN	2CCF212332A0001	1489700	1	6422
96 modules 3LN	1795	ZLSP950E96-3LN	2CCF212333A0001	1489724	1	6554
98 modules 3LN	1831	ZLSP950E98-3LN	2CCF212334A0001	1489748	1	6696
100 modules 3LN	1867	ZLSP950E100-3LN	2CCF212335A0001	1489762	1	6828
102 modules 3LN	1903	ZLSP950E102-3LN	2CCF212336A0001	1489786	1	6959
104 modules 3LN	1939	ZLSP950E104-3LN	2CCF212337A0001	1489809	1	7091
106 modules 3LN	1975	ZLSP950E106-3LN	2CCF212338A0001	1489823	1	7234
108 modules 3LN	2011	ZLSP950E108-3LN	2CCF212339A0001	1489847	1	7365
110 modules 3LN	2047	ZLSP950E110-3LN	2CCF212340A0001	1489861	1	7463

## Starter pack Touch proof 3LN LA LB

### Power Bar System 250 A

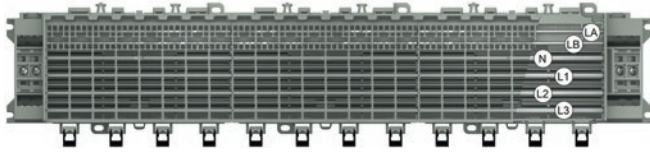

#### Starter Pack 3L: L1, L2, L3 included socket end piece

Solutions available	Busbars length incl. Socket end piece mm	Type name	ABB IT number	EAN number 761 227	Pack unit	Weight in grams
30 modules 3LN LA LB	607	ZLSP950E30-3LNLALB	2CCF212400A0001	1489885	1	2480
32 modules 3LN LA LB	643	ZLSP950E32-3LNLALB	2CCF212401A0001	1489908	1	2611
34 modules 3LN LA LB	679	ZLSP950E34-3LNLALB	2CCF212402A0001	1489922	1	2754
36 modules 3LN LA LB	715	ZLSP950E36-3LNLALB	2CCF212403A0001	1489946	1	2885
38 modules 3LN LA LB	751	ZLSP950E38-3LNLALB	2CCF212404A0001	1489960	1	3017
40 modules 3LN LA LB	787	ZLSP950E40-3LNLALB	2CCF212405A0001	1489984	1	3149
42 modules 3LN LA LB	823	ZLSP950E42-3LNLALB	2CCF212406A0001	1490003	1	3291
44 modules 3LN LA LB	859	ZLSP950E44-3LNLALB	2CCF212407A0001	1490027	1	3423
46 modules 3LN LA LB	895	ZLSP950E46-3LNLALB	2CCF212408A0001	1490041	1	3555
48 modules 3LN LA LB	931	ZLSP950E48-3LNLALB	2CCF212409A0001	1490065	1	3686
50 modules 3LN LA LB	967	ZLSP950E50-3LNLALB	2CCF212410A0001	1490089	1	3829
52 modules 3LN LA LB	1003	ZLSP950E52-3LNLALB	2CCF212411A0001	1490102	1	3961
54 modules 3LN LA LB	1039	ZLSP950E54-3LNLALB	2CCF212412A0001	1490126	1	4092
56 modules 3LN LA LB	1075	ZLSP950E56-3LNLALB	2CCF212413A0001	1490140	1	4224
58 modules 3LN LA LB	1111	ZLSP950E58-3LNLALB	2CCF212414A0001	1490164	1	4366
60 modules 3LN LA LB	1147	ZLSP950E60-3LNLALB	2CCF212415A0001	1490188	1	4498
62 modules 3LN LA LB	1183	ZLSP950E62-3LNLALB	2CCF212416A0001	1490201	1	4630
64 modules 3LN LA LB	1219	ZLSP950E64-3LNLALB	2CCF212417A0001	1490225	1	4761
66 modules 3LN LA LB	1255	ZLSP950E66-3LNLALB	2CCF212418A0001	1490249	1	4904
68 modules 3LN LA LB	1291	ZLSP950E68-3LNLALB	2CCF212419A0001	1490263	1	5036
70 modules 3LN LA LB	1327	ZLSP950E70-3LNLALB	2CCF212420A0001	1490287	1	5167
72 modules 3LN LA LB	1363	ZLSP950E72-3LNLALB	2CCF212421A0001	1490300	1	5299
74 modules 3LN LA LB	1399	ZLSP950E74-3LNLALB	2CCF212422A0001	1490324	1	5442
76 modules 3LN LA LB	1435	ZLSP950E76-3LNLALB	2CCF212423A0001	1490348	1	5573
78 modules 3LN LA LB	1471	ZLSP950E78-3LNLALB	2CCF212424A0001	1490362	1	5705
80 modules 3LN LA LB	1507	ZLSP950E80-3LNLALB	2CCF212425A0001	1490386	1	5836
82 modules 3LN LA LB	1543	ZLSP950E82-3LNLALB	2CCF212426A0001	1490409	1	5979
84 modules 3LN LA LB	1579	ZLSP950E84-3LNLALB	2CCF212427A0001	1490423	1	6111
86 modules 3LN LA LB	1615	ZLSP950E86-3LNLALB	2CCF212428A0001	1490447	1	6242
88 modules 3LN LA LB	1651	ZLSP950E88-3LNLALB	2CCF212429A0001	1490461	1	6374
90 modules 3LN LA LB	1687	ZLSP950E90-3LNLALB	2CCF212430A0001	1490485	1	6517
92 modules 3LN LA LB	1723	ZLSP950E92-3LNLALB	2CCF212431A0001	1490508	1	6648
94 modules 3LN LA LB	1759	ZLSP950E94-3LNLALB	2CCF212432A0001	1490522	1	6780
96 modules 3LN LA LB	1795	ZLSP950E96-3LNLALB	2CCF212433A0001	1490546	1	6912
98 modules 3LN LA LB	1831	ZLSP950E98-3LNLALB	2CCF212434A0001	1490560	1	7054
102 modules 3LN LA LB	1903	ZLSP950E102-3LNLALB	2CCF212436A0001	1490607	1	7317
104 modules 3LN LA LB	1939	ZLSP950E104-3LNLALB	2CCF212437A0001	1490621	1	7449
106 modules 3LN LA LB	1975	ZLSP950E106-3LNLALB	2CCF212438A0001	1490645	1	7592
108 modules 3LN LA LB	2011	ZLSP950E108-3LNLALB	2CCF212439A0001	1490669	1	7723
110 modules 3LN LA LB	2047	ZLSP950E110-3LNLALB	2CCF212440A0001	1490683	1	7821

## Socket system Power Bar System 250 A

Socket base, Busbars for the sockets, Socket end piece

### Socket base

	Description	Type name	ABB IT number	EAN number 761 227	Pack unit	Moduls (1 PLE 18mm)	Weight in grams
	6-module socket Length 108 mm (includes base and cover)	ZLSP906	2CCF212053A0001	148 7324	10	6	113
	8-module socket Length 144 mm (includes base and cover)	ZLSP908	2CCF212052A0001	148 7300	10	8	147

### Busbars for the sockets

	Description	Type name	ABB IT number	EAN number 761 227	Packaging unit	Module	Weight in grams
	250A busbar plated, 25x3 mm, for L1, L2, L3, N and PE – Delivery length 1979 mm	ZLSP1250	2CCF212100M0110	148 8222	1	110	1343
	40A auxiliary busbar plated, 5x2 mm, for LA und LB – Delivery length 1979 mm	ZLS202	2CCF002773R0001	001 5719	10	110	240

### Socket end piece main socket

	Description	Type name	ABB IT number	EAN number 761 227	Packaging unit	Module	Weight in grams
	End piece main socket ZLSP906 or ZLSP908 (Bag cont. 2 pcs.: 1 pc. left/ 1 pc. right)	ZLSP920	2CCF212082A0001	148 7386	1	2	103

## Socket system Power Bar System 250 A

### Additional socket

#### Additional socket

The additional socket can easily be fitted onto the socket base to accommodate the external N and/or PE busbars. This enables neutral connections to be made where single-pole miniature circuit breakers are used with unswitched neutral.

Neutral terminals are clipped onto the additional socket and can be used as detachable neutral connections. One N busbar and/or one PE busbar can be fitted. Each socket base can be equipped with an additional socket.

#### Additional socket for external N and PE busbars

	Type name	ABB IT number	EAN number 761 227	Pack- aging unit	Module	Weight in grams	
	- 8-module socket (suitable for 8-module socket)	ZLSP928	2CCF212060A0001	148 7348	10	8	67
	- 6-module socket (suitable for 6-module socket)	ZLSP926	2CCF212061A0001	148 7362	10	6	53



#### Socket end piece additional socket

	Type name	ABB IT number	EAN number 761 227	Pack- aging unit	Module	Weight in grams	
	End piece additional socket ZLSP926 or ZLSP928 (Bag cont. 2 pcs.: 1 pc. left/ 1 pc. right)	ZLSP921	2CCF212085A0001	148 7409	1	2	54

#### Busbar insulator

	Type name	ABB IT number	EAN number 761 227	Pack- aging unit	Module	Weight in grams	
	dark grey, 20 for isolation and spacing of separate busbar sections, 18mm	ZLS938	2CCA205611R0001	141 8205	1	1	1















#### Busbar cover

	Type name	ABB IT number	EAN number 761 227	Pack- aging unit	Module	Weight in grams	
	electrically protected covering of main and auxiliary busbars. The 4 modules cover can be divided. Suitable to accept extension adapter ZLS 101 4x18mm - bag containing 5 items	ZLS100	2CCF002762R0001	001 5603	1	1	95
	DIN rail Clip for ZLSP926 and ZLSP928. This item is need if the additional socket will be mounted on a DIN rail. 1 pcs. every 30cm	ZLSP937	2CCA212012R0001	498 306	Bag of 5	-	18

## Incoming devices and terminals

Technical data IEC/EN 61439-6 and UL508

### Incoming blocks

	ZLSP934 and 935	ZLSP25X,ZLSP95X
	<b>Standards</b>	IEC/EN 61439-6
	Rated voltage $U_e$ acc. IEC acc. IEC	690 VAC
	Rated voltage $U_e$ acc. IEC acc. IEC	690 VAC
	Rated Voltage acc. UL	600 V AC
	Rated current $I_n$ acc. IEC	250 A (center feed or side feed): 400 A max. when used with two feeder blocks
	Rated current $I_n$ acc. UL	250 A
	Rated current $I_n$ acc. UL	250 A (short circuit protection 250 A Circuit-Breaker (DIVQ/7) 50 kA (480 V); 35 kA (600 V)
	Wire size IEC connections	Cable: 50 mm <sup>2</sup> up to 150 mm <sup>2</sup> ; no flat cable Ring lug M8 (for example Klauke 9SG8 for 120mm <sup>2</sup> or 10SG8 for 150mm <sup>2</sup> )
	Wire size UL connections	35–120 mm <sup>2</sup> one flexible wire with ferrule 10–25 mm <sup>2</sup> one or two flexible wire with ferrule
	Wire size UL connections	4/0AWG – 250 kcmil
	Torque	8Nm Cover 1,2 Nm
	Torque	ZLSP250–253 2,5 Nm ZLSP954, 959 2,0 Nm Cover 1,2 Nm
	Stripping length	Ring lug M8; Width: max 22 mm
	Stripping length	21 mm

## Socket system Power Bar System 250A

### Incoming terminal block and component

#### Incoming block bolt-on solution M8 50mm<sup>2</sup> up to 150mm or 4/0AWG for UL

Connection can be done with ring lug like Klauke 9SG8 for 120 mm<sup>2</sup> or 10SG8 for 150 mm<sup>2</sup>. Connection of two socket rows is possible.

This solution is only possible to mount on a ZLSP908 (not on ZLSP906, ZLS906, ZLS908)

	Version	Type name	ABB IT number	EAN number 761 227	Pack-aging unit	Module	Weight in grams
	<b>Main Socket</b>						
	Incoming terminal block 3L left 250A	ZLSP934-3L-1	2CCG000036R0001	150 6124	1	8	438
	Incoming terminal block 3L+N left 250A	ZLSP934-3LN	2CCG000038R0001	150 6148	1	8	528
	Incoming terminal block 3L right 250A	ZLSP934-3L-R-1	2CCG000039R0001	150 6155	1	8	438
	Incoming terminal block 3L+N right 250A	ZLSP934-3LN-R	2CCG000041R0001	150 6179	1	8	528
	<b>Additional socket</b>						
	Incoming terminal block additional socket N PE left 250A This solution is only possible to mount on a ZLSP928 (not on ZLSP926, ZLS926, ZLS928).	ZLSP935-8NPE	2CCG000042R0001	150 6186	1	8	268
	Incoming terminal block additional socket PE left 250A	ZLSP935-8PE	2CCG000043R0001	150 6193	1	8	178
	Incoming terminal block additional socket N PE right 250A	ZLSP935-8NPE-R	2CCG000046R0001	150 6223	1	8	268
	Incoming terminal block additional socket PE right 250A	ZLSP935-8PE-R	2CCG000047R0001	150 6230	1	8	178
	<b>Covers for ZLSP934</b>						
	Cover for Incoming terminal block 250A (only for replacement)	ZLSP963	2CCG000051R0001	150 6278	1	2	18
	<b>Connection N to N (Main socket to Additional socket)</b>						
	Connection to wire N from main socket to additional socket. Can only use for M8 120 mm <sup>2</sup> . Feeding is only possible form the main socket side.	ZLSP963N-N	2CCG000050R0001	150 6261	1	2	74
<b>Cover for wiring by using 2 rows</b>							
Cover for connection with the cables on one terminal (Pac à 4 pcs)	ZLSP964	2CCG000207R0001	150 7541	1	2	34	

#### Incoming terminal component 250A

	Version	Type name	ABB IT number	EAN number 761 227	Pack-aging unit	Module	Weight in grams
	Feeder component N	ZLSP250	2CCV672600R0001	149 0782	1	2	112
	Feeder component L1	ZLSP251	2CCV672601R0001	149 0805	1	2	112
	Feeder component L2	ZLSP252	2CCV672602R0001	149 0829	1	2	112
	Feeder component L3	ZLSP253	2CCV672603R0001	149 0843	1	2	112
	Feeder component N additional socket	ZLSP954	2CCV672608R0001	149 0867	1	2	100
	Feeder component N additional socket (2 holes)	ZLSP954-1	2CCG000034R0001	150 6100	1	2	100
	Feeder component PE additional socket	ZLSP959	2CCV672609R0001	149 0881	1	2	100

#### Cover for Incoming block 250A

Cover for Incoming block 250A	ZLSP25D	2CCA183484R0001	150 1426	1	2	23
-------------------------------	---------	-----------------	----------	---	---	----

## Terminal range IEC for additional socket

For 250 A system (use on ZLSP926/928 or ZLS926/928)

### N terminals and PE terminals

Corresponding N terminals (blue) or PE terminals (yellow-green) are available for the power supply and the outgoing conductors of the external N and PE busbars for cross sections. The terminals are fitted with label holders which can be used with the marking adapter or the marking label (Phoenix Contact type Clipline UC-TM).

#### N terminal for additional socket light blue, for external busbars

	Type name	ABB IT number	EAN number 761 227	Pack- aging unit	Module	Weight in grams
	N 10 mm <sup>2</sup>	ZLS918	2CCA183440R0001	148 7027	Set of 10	0.5 11
	N 35 mm <sup>2</sup>	ZLS913	2CCA183470R0001	142 1304	1	1 30
	N 95 mm <sup>2</sup>	ZLS954	2CCV672508R0001	142 4404	1	2 100
	N 95 mm <sup>2</sup> two holes	ZLS954-1	2CCG001032R0001	151 5348	1	2 100



#### PE terminal for additional socket yellow-green, for external busbars

	PE 10 mm <sup>2</sup>	ZLS919	2CCA183441R0001	148 7041	Set of 10	0.5 11
	PE 35 mm <sup>2</sup>	ZLS929	2CCA183387R0001	148 6921	1	1 30
	PE 95 mm <sup>2</sup>	ZLS959	2CCA672510R0001	148 7164	1	2 100

#### Red/orange terminals for additional socket

	10 mm <sup>2</sup>	ZLS918/Red	2CCA183443R0001	148 7089	1	0.5 11
	10 mm <sup>2</sup>	ZLS919/Orange	2CCA183444R0001	148 7102	1	0.5 11
	10 mm <sup>2</sup>	ZLS918/Black	2CCA183445R0001	148 7126	1	0.5 11
	35 mm <sup>2</sup>	ZLS913/Red	2CCA183465R0001	142 1342	1	1 30
	35 mm <sup>2</sup>	ZLS916/Orange	2CCA183466R0001	142 1366	1	1 30

### Insulator block

The dark grey insulator block isolates the interrupted bus bar ends from one another and simultaneously marks the disconnection point externally.

#### Insulator block for additional socket

	Type name	ABB IT number	EAN number 761 227	Pack- aging unit	Module	Weight in grams
	dark gray, to isolate the N bus bar on the additional socket	ZLS927	2CCA183442R0001	148 7065	1	0.5 9

## Socket system Power Bar System 250 A

### Busbars 40 A and 250 A

250 A and 40 A busbars / selection table for sockets

Order data busbar 250 A	ABB IT number	EAN number 761227	ZLSP908	ZLSP906	Pack unit	Moduls (1 PLE 18mm)	Weight in grams	Busbar length in mm	Order data busbar 40 A	ABB IT number	EAN number 761 227
ZLSP1250E30	2CCF212100M0030	148 7423	3	1	1	30	366	535	ZLS203E30	2CCF800229R0001	001 7669
ZLSP1250E32	2CCF212100M0032	148 7447	4	–	1	32	391	571	ZLS203E32	2CCF800230R0001	001 7683
ZLSP1250E34	2CCF212100M0034	148 7461	2	3	1	34	415	607	ZLS203E34	2CCF800231R0001	001 7706
ZLSP1250E36	2CCF212100M0036	148 7485	3	2	1	36	439	643	ZLS203E36	2CCF800232R0001	001 7720
ZLSP1250E38	2CCF212100M0038	148 7508	4	1	1	38	464	679	ZLS203E38	2CCF800233R0001	001 7744
ZLSP1250E40	2CCF212100M0040	148 7522	5	–	1	40	488	715	ZLS203E40	2CCF800234R0001	001 7768
ZLSP1250E42	2CCF212100M0042	148 7546	3	3	1	42	513	751	ZLS203E42	2CCF800235R0001	001 7782
ZLSP1250E44	2CCF212100M0044	148 7560	4	2	1	44	537	787	ZLS203E44	2CCF800236R0001	001 7805
ZLSP1250E46	2CCF212100M0046	148 7584	5	1	1	46	561	823	ZLS203E46	2CCF800237R0001	001 7829
ZLSP1250E48	2CCF212100M0048	148 7607	6	–	1	48	586	859	ZLS203E48	2CCF800238R0001	001 7843
ZLSP1250E50	2CCF212100M0050	148 7621	4	3	1	50	610	895	ZLS203E50	2CCF800239R0001	001 7867
ZLSP1250E52	2CCF212100M0052	148 7645	5	2	1	52	635	932	ZLS203E52	2CCF800240R0001	001 7881
ZLSP1250E54	2CCF212100M0054	148 7669	6	1	1	54	659	968	ZLS203E54	2CCF800241R0001	001 7904
ZLSP1250E56	2CCF212100M0056	148 7683	7	–	1	56	683	1004	ZLS203E56	2CCF800242R0001	001 7928
ZLSP1250E58	2CCF212100M0058	148 7706	5	3	1	58	708	1040	ZLS203E58	2CCF800243R0001	001 7942
ZLSP1250E60	2CCF212100M0060	148 7720	6	2	1	60	732	1076	ZLS203E60	2CCF800244R0001	001 7973
ZLSP1250E62	2CCF212100M0062	148 7744	7	1	1	62	757	1112	ZLS203E62	2CCF800245R0001	001 7997
ZLSP1250E64	2CCF212100M0064	148 7768	8	–	1	64	781	1148	ZLS203E64	2CCF800246R0001	001 8017
ZLSP1250E66	2CCF212100M0066	148 7782	6	3	1	66	806	1184	ZLS203E66	2CCF800247R0001	001 8031
ZLSP1250E68	2CCF212100M0068	148 7805	7	2	1	68	830	1220	ZLS203E68	2CCF800248R0001	001 8055
ZLSP1250E70	2CCF212100M0070	148 7829	8	1	1	70	854	1256	ZLS203E70	2CCF800249R0001	001 8079
ZLSP1250E72	2CCF212100M0072	148 7843	9	–	1	72	879	1292	ZLS203E72	2CCF800250R0001	001 8093
ZLSP1250E74	2CCF212100M0074	148 7867	7	3	1	74	903	1328	ZLS203E74	2CCF800251R0001	001 8116
ZLSP1250E76	2CCF212100M0076	148 7881	8	2	1	76	928	1364	ZLS203E76	2CCF800252R0001	001 8130
ZLSP1250E78	2CCF212100M0078	148 7904	9	1	1	78	952	1400	ZLS203E78	2CCF800253R0001	001 8154
ZLSP1250E80	2CCF212100M0080	148 7928	10	–	1	80	976	1436	ZLS203E80	2CCF800254R0001	001 8185
ZLSP1250E82	2CCF212100M0082	148 7942	8	3	1	82	1001	1472	ZLS203E82	2CCF800255R0001	001 8208
ZLSP1250E84	2CCF212100M0084	148 7966	9	2	1	84	1025	1508	ZLS203E84	2CCF800256R0001	001 8222
ZLSP1250E86	2CCF212100M0086	148 7980	10	1	1	86	1050	1544	ZLS203E86	2CCF800257R0001	001 8246
ZLSP1250E88	2CCF212100M0088	148 8000	11	–	1	88	1074	1580	ZLS203E88	2CCF800258R0001	001 8260
ZLSP1250E90	2CCF212100M0090	148 8024	9	3	1	90	1098	1616	ZLS203E90	2CCF800259R0001	001 8284
ZLSP1250E92	2CCF212100M0092	148 8048	10	2	1	92	1123	1652	ZLS203E92	2CCF800260R0001	001 8307
ZLSP1250E94	2CCF212100M0094	148 8062	11	1	1	94	1147	1688	ZLS203E94	2CCF800261R0001	001 8321
ZLSP1250E96	2CCF212100M0096	148 8086	12	–	1	96	1172	1724	ZLS203E96	2CCF800262R0001	001 8345
ZLSP1250E98	2CCF212100M0098	148 8109	10	3	1	98	1196	1760	ZLS203E98	2CCF800263R0001	001 8369
ZLSP1250E100	2CCF212100M0100	148 8123	11	2	1	100	1220	1796	ZLS203E100	2CCF800264R0001	001 7195
ZLSP1250E102	2CCF212100M0102	148 8147	12	1	1	102	1245	1832	ZLS203E102	2CCF800265R0001	001 7218
ZLSP1250E104	2CCF212100M0104	148 8161	13	–	1	104	1269	1868	ZLS203E104	2CCF800266R0001	001 7232
ZLSP1250E106	2CCF212100M0106	148 8185	11	3	1	106	1294	1904	ZLS203E106	2CCF800267R0001	001 7256
ZLSP1250E108	2CCF212100M0108	148 8208	12	2	1	108	1318	1940	ZLS203E108	2CCF800268R0001	001 7270

Planning for the incorporation of feeder block and spare places should be taken into account.  
The total lengths given above were calculated taking socket spacings and tolerances into account.  
For this reason, the indicated busbar length is not necessarily a multiple of 18 mm (1 Module).



## Busbar system 250 A

Technical data according to IEC/EN 61439-6

Direct feed use with XT4 plug-in version only

The direct feed starter pack solution allows a direct connection from the 250 A Power Bar System to the Installation for plug-in circuit-breaker Tmax XT4 Moulded Case Circuit Breaker. Lower part for plug-in for Tmax XT4, 3pole (1SDA068196R1) or 4pole (1SDA068198R1) is needed.

For fixed XT4 version a conversion kit for moving part plug-in is needed additional. 3pole (1SDA066282R1) and 4 pole (SDA066283R1).

The solution is built for a vertical design.

The additional heat sink part is helpful to reduce the heat on the system.

### Direct Feed 250A

Busbar system touch proof:

Use only for wall mounted application (horizontal or vertical). When installed correctly the requirements of EN/IEC 61439-2 are met.



Number of poles	32 to 80 3P+N, additional socket N and PE
Rated operational voltage ( $U_e$ )	690VAC, 440VDC (400V for LA, LB busbars)
Rated insulation voltage ( $U_i$ )	690VAC, 440VDC
IP Code	IP20B
Pollution degree	3 (690Va.c.) 2 (1000Vd.c.)
Rated impulse voltage ( $U_{imp}$ )	8 kV (L1L2L3N)
Rated current of the assembly ( $I_{nA}$ )	250A
Rated current of a circuit ( $I_{nc}$ ): main circuit	Max. 250A
Rated current of Auxiliary circuit	40A
Rated short-time withstand current ( $I_{cw}$ )	15kA/100ms Main circuit, 4kA/50ms Auxiliary circuit
Rated peak withstand current Main circuit ( $I_{pk}$ )	30kA
Rated peak withstand current Auxiliary circuit ( $I_{pk}$ )	6kA
Rated frequency (f)	50/60Hz
Rated conditional short-circuit current ( $I_{cc}$ ): see table below	
Ambient air temperature	max. 60°C
Size of CU bars 3P+N+PE	3 x 25 mm (75 mm <sup>2</sup> )
Size of CU auxiliary bars La Lb	2 x 5 mm (10 mm <sup>2</sup> )
Environmental conditions (damp heat)	1 cycle with 55°C/90...96% and 25°C/95...100%
Ambient temperature	-25 ... +60°C
Storage temperature	-40 ... +70°C

Voltage (VAC)	Rated conditional short-circuit current ( $I_{cc}$ )	Incoming current of main busbars (L1, L2, L3, N)	Short circuit protection device (SCPD)
415V	100kA	250A	ABB
690V	25kA	250A	Tmax XT4 250A

Technical data data UL508; Approvals for US and CA: cULus  
Direct Feed 250A

**SMISLINE TP system for UL 508 – Industrial Control Equipment,  
CSA C22.2 No. 14 – Industrial Control Equipment UL File E222110**

**Control Equipment UL File E222110**

UL Rated Voltage	600 VAC
UL Rated Current (End Feed)	250A
UL Short Circuit Rating	50kA (480V), 35kA (600V) with XT4 250A

## Direct Feed Touch proof 3L and 3LN

### Power Bar System 250 A

At the first 12 module positions close to the XT4 a derating of 0,76 shall be applied.

For the other modules the derating is according the data from the technical catalogue for MCB,

RCD, RCBOs. The specific deratings for devices for influence of adjacent poles and ambient temperature must be still carefully attended in any case.

#### Ordering data

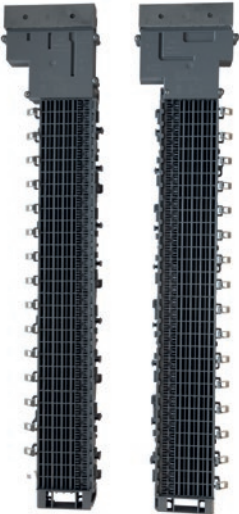
	Solutions available	direct feed length incl. Socket end piece mm	Type name	ABB IT number	EAN number 761 227	Pack unit	Weight in grams
	32PLE 3L left	742	ZLSP960-3L-32-L	2CCG000155R0001	150 7022	1	2868
	32PLE 3LN left	742	ZLSP960-3LN-32-L	2CCG000156R0001	150 7039	1	4258
	32PLE 3L right	742	ZLSP960-3L-32-R	2CCG000157R0001	150 7046	1	3258
	32PLE 3LN right	742	ZLSP960-3LN-32-R	2CCG000158R0001	150 7053	1	4258
	40PLE 3L left	886	ZLSP960-3L-40-L	2CCG000159R0001	150 7060	1	3308
	40PLE 3LN left	886	ZLSP960-3LN-40-L	2CCG000160R0001	150 7077	1	4796
	40PLE 3L right	886	ZLSP960-3L-40-R	2CCG000161R0001	150 7084	1	3308
	40PLE 3LN right	886	ZLSP960-3LN-40-R	2CCG000162R0001	150 7091	1	4796
	48PLE 3L left	1030	ZLSP960-3L-48-L	2CCG000163R0001	150 7107	1	3747
	48PLE 3LN left	1030	ZLSP960-3LN-48-L	2CCG000164R0001	150 7114	1	5333
	48PLE 3L right	1030	ZLSP960-3L-48-R	2CCG000165R0001	150 7121	1	3747
	48PLE 3LN right	1030	ZLSP960-3LN-48-R	2CCG000166R0001	150 7138	1	5333
	56PLE 3L left	1174	ZLSP960-3L-56-L	2CCG000167R0001	150 7145	1	4187
	56PLE 3LN left	1174	ZLSP960-3LN-56-L	2CCG000168R0001	150 7152	1	5871
	56PLE 3L right	1174	ZLSP960-3L-56-R	2CCG000169R0001	150 7169	1	4187
	56PLE 3LN right	1174	ZLSP960-3LN-56-R	2CCG000170R0001	150 7176	1	5871
	64PLE 3L left	1318	ZLSP960-3L-64-L	2CCG000171R0001	150 7183	1	4627
	64PLE 3LN left	1318	ZLSP960-3LN-64-L	2CCG000172R0001	150 7190	1	6408
	64PLE 3L right	1318	ZLSP960-3L-64-R	2CCG000173R0001	150 7206	1	4627
	64PLE 3LN right	1318	ZLSP960-3LN-64-R	2CCG000174R0001	150 7213	1	6408
	66PLE 3L left	1354	ZLSP960-3L-66-L	2CCG000175R0001	150 7220	1	4746
	66PLE 3LN left	1354	ZLSP960-3LN-66-L	2CCG000176R0001	150 7237	1	6551
	66PLE 3L right	1354	ZLSP960-3L-66-R	2CCG000177R0001	150 7244	1	4746
	68PLE 3LN right	1390	ZLSP960-3LN-66-R	2CCG000178R0001	150 7251	1	6551
	68PLE 3L left	1390	ZLSP960-3L-68-L	2CCG000179R0001	150 7268	1	4853
	68PLE 3LN left	1390	ZLSP960-3LN-68-L	2CCG000180R0001	150 7275	1	6683
	68PLE 3L right	1390	ZLSP960-3L-68-R	2CCG000181R0001	150 7282	1	4853
	70PLE 3LN right	1426	ZLSP960-3LN-68-R	2CCG000182R0001	150 7299	1	6683
	70PLE 3L left	1426	ZLSP960-3L-70-L	2CCG000183R0001	150 7305	1	4960
	70PLE 3LN left	1426	ZLSP960-3LN-70-L	2CCG000184R0001	150 7312	1	6814
	70PLE 3L right	1426	ZLSP960-3L-70-R	2CCG000185R0001	150 7329	1	4960
	72PLE 3LN right	1462	ZLSP960-3LN-70-R	2CCG000186R0001	150 7336	1	6814
	72PLE 3L left	1462	ZLSP960-3L-72-L	2CCG000187R0001	150 7343	1	5067
	72PLE 3LN left	1462	ZLSP960-3LN-72-L	2CCG000188R0001	150 7350	1	6946
	72PLE 3L right	1462	ZLSP960-3L-72-R	2CCG000189R0001	150 7367	1	5067
	74PLE 3LN right	1498	ZLSP960-3LN-72-R	2CCG000190R0001	150 7374	1	6946
	74PLE 3L left	1498	ZLSP960-3L-74-L	2CCG000191R0001	150 7381	1	5185
	74PLE 3LN left	1498	ZLSP960-3LN-74-L	2CCG000192R0001	150 7398	1	7089
	74PLE 3L right	1498	ZLSP960-3L-74-R	2CCG000193R0001	150 7404	1	5185
	76PLE 3LN right	1534	ZLSP960-3LN-74-R	2CCG000194R0001	150 7411	1	7089
76PLE 3L left	1534	ZLSP960-3L-76-L	2CCG000195R0001	150 7428	1	5293	
76PLE 3LN left	1534	ZLSP960-3LN-76-L	2CCG000196R0001	150 7435	1	7220	
76PLE 3L right	1534	ZLSP960-3L-76-R	2CCG000197R0001	150 7442	1	5293	
78PLE 3LN right	1570	ZLSP960-3LN-76-R	2CCG000198R0001	150 7459	1	7220	
78PLE 3L left	1570	ZLSP960-3L-78-L	2CCG000644R0001	150 7466	1	5400	
78PLE 3LN left	1570	ZLSP960-3LN-78-L	2CCG000200R0001	150 7473	1	7352	
78PLE 3L right	1570	ZLSP960-3L-78-R	2CCG000645R0001	150 7480	1	5400	
80PLE 3LN right	1606	ZLSP960-3LN-78-R	2CCG000202R0001	150 7497	1	7352	
80PLE 3L left	1606	ZLSP960-3L-80-L	2CCG000203R0001	150 7503	1	5507	
80PLE 3LN left	1606	ZLSP960-3LN-80-L	2CCG000204R0001	150 7510	1	7483	
80PLE 3L right	1606	ZLSP960-3L-80-R	2CCG000205R0001	150 7527	1	5507	
80PLE 3LN right	1606	ZLSP960-3LN-80-R	2CCG000206R0001	150 7534	1	7483	

## Busbar system 250 A



### Direct feed Accessories

At the first 12 module positions close to the XT4 a derating of 0,76 shall be applied.

For the other modules the derating is according the data from the technical catalogue for MCB,

RCCB, RCBOs. The specific deratings for devices for influence of adjacent poles and ambient temperature must be still carefully attended in any case.

#### Ordering data

	Solutions available	Type name	ABB IT number	EAN number 761 227	Pack unit	Weight in grams
	Heatsink 3L	ZLSP960HS-3L	2CCG000736R0001	151 2446	1	197
	Heatsink 3LN	ZLSP960HS-3LN	2CCG000739R0001	151 2453	1	262
	Screws (only for replacement, all screws are included in direct feed)	ZLSP960screw	2CCG000361R0001	150 8401		55
						
						



# Table of contents

<b>01. Technical details</b>	100
<b>02. Technical details</b>	101–102
<b>03. DIN adapter IEC</b>	103
<b>04. DIN adapter UL</b>	104

## Combi modules adapter for manual motor starter and DIN adapters

Technical data IEC/EN 61439-6 and UL508

—  
**Modules can be used on the 125A or on the 250A busbar system. Combi module for MS116/MS132 and AF contactor Motor starter MS116/132 and AF contactors are not part of this catalogue.**

	ZMS132 Combi Module	ZMS 930 Adapter	ZLS970 DIN Adapter IEC	ZLS970UL DIN Adapter UL489
Standards	IEC/EN 61439-6	UL 508 CSA C22.2 No. 14-13	IEC/EN 61439-6	UL 508 CSA C22.2 No. 14-13
Rated voltage U <sub>e</sub> acc. IEC acc. IEC	690 VAC, 440 V DC	690 VAC, 440 V DC	690 VAC, 440 V DC	
Rated Voltage acc. UL	600 V AC	600 V AC	600 V AC	240 V AC
Rated current I <sub>n</sub> acc.. IEC	32 A	32 A	32 A, 63 A Maximum rated current of outgoing circuits (I <sub>nc</sub> ) max. 50 A for S800 with ZLS972X, ZLS973X.	
Rated current I <sub>n</sub> acc. UL	30 A	30 A	30 A, 60 A	25 A, 45 A

## Combi module: starting solutions in kit form

### Mounting possibilities

#### Direct-On-Line Starters

MS116

- + BEA16-4
- + AF09, AF12, AF16

MS116 up to 16 A

- + BEA26-4
- + AF26, AF30, AF38

MS116 > 16 A

- + BEA38-4
- + AF26, AF30, AF38

MS132

- + BEA16-4
- + AF09, AF12, AF16

MS132 up to 10 A

- + BEA26-4
- + AF26, AF30, AF38

MS132 > 10 A

- + BEA38-4
- + AF26, AF30, AF38



with control voltage

#### Mounting possibilities on the combi module:

The following combinations of contactor, motor circuit breaker and connector are possible on the combi module.

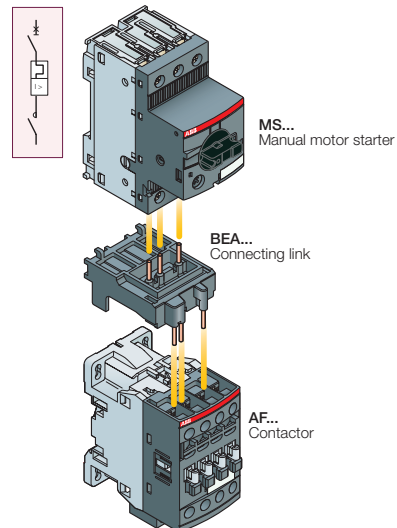

#### Reversing Starters

MS116

- + BEA16-4, BER16-4, VEM4
- + AF09, AF12, AF16

MS116 up to 16 A

- + BEA26-4, BER38-4, VEM4
- + AF26, AF30, AF38

MS116 > 16 A

- + BEA38-4, BER38-4, VEM4
- + AF26, AF30, AF38

MS132

- + BEA16-4, BER16-4, VEM4
- + AF09, AF12, AF16

MS132 up to 10 A

- + BEA26-4, BER38-4, VEM4
- + AF26, AF30, AF38

MS132 > 10 A

- + BEA38-4, BER38-4, VEM4
- + AF26, AF30, AF38



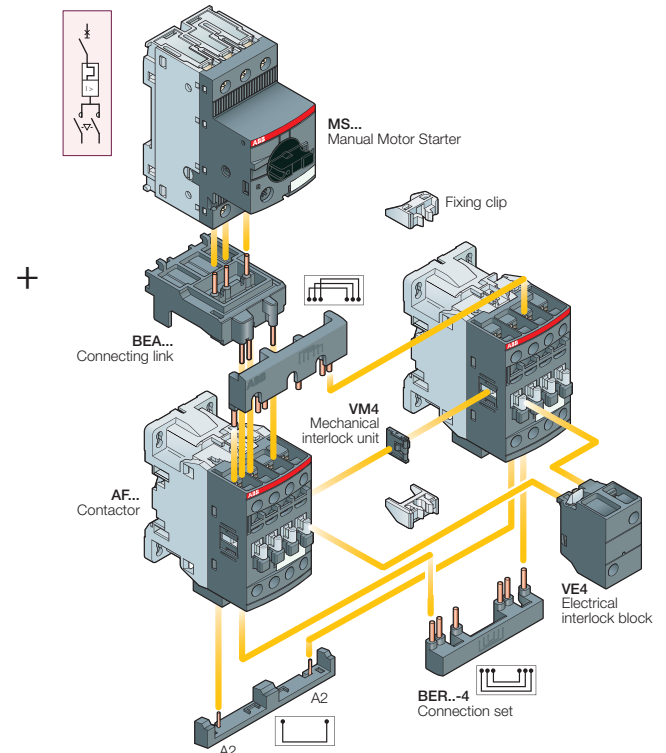

without control voltage



## Combi modules cadapter for manual motor starter and DIN adapters

Technical data IEC/EN 61439-6 and UL508

### Combi module for manual motor starter plus adapter plus contactor

	Description/ application	Bbn 761 227 EAN	Type code	Aborder code	Pack unit	Module	Weight 1 piece
	L1,L2,L3	141 4641	ZMS132-3L	2CCA182500R0001	1	2.5	0.095
	L1,L2,L3,LA	141 4634	ZMS132-3LA	2CCA182502R0001	1	2.5	0.098
	L1,L2,L3,LB	141 4627	ZMS132-3LB	2CCA182504R0001	1	2.5	0.098
	L1, L2,L3, LA, LB	141 4610	ZMS132-3LAB	2CCA182506R0001	1	2.5	0.102
<b>Modules for wire bottom feed</b>	L1,L2,L3	150 3208	ZMS132-3LWB	2CCF182543R0001	1	2.5	0.105
<b>Module for manual motor starter MS132 K Push-in terminals wires top feed</b>	L1, L2, L3	150 3178	ZMS132-3L-PI	2CCF182540R0001	1	2.5	0.105
	L1, L2, L2, LB	150 3185	ZMS132-3LB-PI	2CCF182541R0001	1	2.5	0.118
	L1, L2, L2, LA, LB	150 3192	ZMS132-3LAB-PI	2CCF182542R0001	1	2.5	0.136
<b>Module without wires, Spare parts</b>	Combi module without wires	141 4603	ZMS137	2CCA182508R0001	1	2.5	0.075
	Intermediate piece 9 mm	141 4412	ZMS935	2CCA182616R0001	1	2.5	0.007
	Connection pin to mount 2 combi modules together	141 4801	E210-SPV	2CCC703715R0001	Set of 30 pces		0.01

### Adapter for manual motor starter plus adapter plus contactor

	EAN number 761 227	Type name	ABB IT number	Pack unit	Module	Weight in grams
<b>Adapter for MS116 and MS132 wire bottom feed</b>						
L1, L2, L3	141 4597	ZMS930	2CCA182520R0001	1	2.5	0.053
L1, L2, L3, LA, LB	141 4580	ZMS931	2CCA182522R0001	1	2.5	0.062
L1,L2,L3,LA	142 4619	ZMS936	2CCA182521R0001	1	2.5	0.058
<b>Adapter for MS116 and MS132 wires top feed</b>						
L1, L2, L3	141 4573	ZMS932	2CCA182524R0001	1	2.5	0.053
L1, L2, L3, LA, LB	141 4566	ZMS933	2CCA182526R0001	1	2.5	0.062
L1,L2,L3,LA	142 4626	ZMS937	2CCA182525R0001	1	2.5	0.058
<b>Adapter for manual motor starter MS132 K Push-in terminals wires</b>						
 <p style="text-align: center;">Top feed      Bottom feed</p>						
L1,L2,L3 wires bottom	150 3215	ZMS930-PI	2CCF182550R0001	1	2.5	0.058
L1,L2,L3 wires top	150 3208	ZMS932-PI	2CCF182551R0001	1	2.5	0.058
<b>Adapter MS116 and MS132 without wires, Spare parts</b>						
Adapter for MS without wires	141 4559	ZMS934	2CCA182512R0001	1	2.5	0.034
Intermediate piece 9 mm	141 4412	ZMS935	2CCA182616R0001	1	2.5	0.007
Adapter for AF contactor no wires	141 4542	ZMS938	2CCA182510R0001	1	2.5	0.0034
Connection pin to mount 2 combi modules together	141 4801	E210-SPV	2CCC703715R0001	Set of 30 pces		0.01

## DIN adapters

IEC and UL508 32 A, 63 A

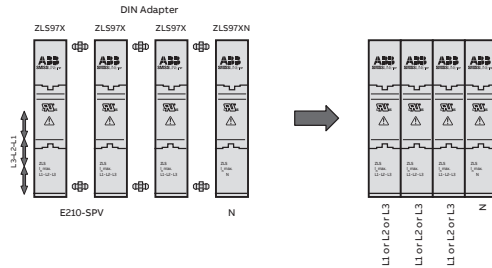

**Litzenlänge ZLS97X**

**Bottom:**

N: 68 mm

L1: 100 mm

L2: 114 mm

L3: 126 mm

**Top:**

N: 86 mm

L1: 94 mm

L2: 80 mm

L3: 88 mm

Multipole universal adapter can plugged together with single adapters and the connection piece E210SPV.

If you need the length up to the extreme end of the wire please add 20 mm (ferrule length).

### DIN adapters 32 A and 63 A, Adapter for use EN/IEC 61439-6 or UL508

Adapters can be used on the 125A or on the 250A busbar system.

Designation	Type name	ABB IT number	EAN number 761 227	Pack- aging unit	Module	Weight in grams
<b>Adapter 32A</b>						
L1 or L2 or L3 wire top	ZLS970	2CCA180551R0001	144 4563	10	1	20
L1 or L2 or L3 wire bottom	ZLS971	2CCA180552R0001	144 4570	10	1	20
N wire top	ZLS970N	2CCA180553R0001	144 4587	10	1	20
N wire bottom	ZLS971N	2CCA180554R0001	144 4570	10	1	20
<b>Adapter 63A</b>						
L1 or L2 or L3 wire top	ZLS972	2CCA180555R0001	144 4709	10	1	24
L1 or L2 or L3 wire bottom	ZLS973	2CCA180556R0001	144 4716	10	1	24
N wire top	ZLS972N	2CCA180557R0001	144 4723	10	1	24
N wire bottom	ZLS973N	2CCA180558R0001	144 4730	10	1	24
<b>Adapter 32A with 300mm wire</b>						
L1 or L2 or L3 wire top	ZLS970300	2CCA180559R0001	144 4747	10	1	26
L1 or L2 or L3 wire bottom	ZLS971300	2CCA180560R0001	144 4754	10	1	26
N wire top	ZLS970N300	2CCA180561R0001	144 4761	10	1	26
N wire bottom	ZLS971N300	2CCA180562R0001	144 4778	10	1	26
<b>Adapter 63A with 300mm wire</b>						
L1 or L2 or L3 wire top	ZLS972300	2CCA180563R0001	144 4785	10	1	37
L1 or L2 or L3 wire bottom	ZLS973300	2CCA180564R0001	144 4792	10	1	37
N wire top	ZLS972N300	2CCA180565R0001	144 4808	10	1	37
N wire bottom	ZLS973N300	2CCA180566R0001	144 4815	10	1	37



## Adapters for MCB SU200 and SUP200

UL489 25A, 45A; Circuit breaker accessories E257901

### Adapters

Adapters can be used on the 125A or on the 250A busbar system.



#### Adapter 25A UL489, adapter can be only used together with ABB for MCB SU200 and SUP200

L1 or L2 or L3 wire top	ZLS970UL	2CCA337020R0001	144 4822	10	1	21
L1 or L2 or L3 wire bottom	ZLS971UL	2CCA337021R0001	144 4839	10	1	21



#### Adapter 45A UL489, adapter can be only used together with ABB for MCB SU200 and SUP200

L1 or L2 or L3 wire top	ZLS972UL	2CCA337024R0001	144 4860	10	1	25
L1 or L2 or L3 wire bottom	ZLS973UL	2CCA337025R0001	144 4877	10	1	25

### Accessory



#### Dummy housing

18mm wide	ZLS964	2CCA180550R0001	144 4556	10	1	11
-----------	--------	-----------------	----------	----	---	----

#### Connector for multi-pole adapter

Bag with 30 pcs. 2 connectors are needed to connect 2 adapters	E210-SPV	2CCC703715R0001	141 4801	Set of 30 pcs.		50
--	----------	-----------------	----------	-------------------	--	----

# Adapter for S800

27 mm wide Solution for S800

Simple mounting S800 MCB on SMISSLINE TP system with 27mm wide DIN Rail adapter.  
 Assembly to plug-in socket system with DIN Rail

adapter and S800. Maximum rated current of outgoing circuits ( $I_{nc}$ ) max. 50A for S800 with ZLS972X, ZLS973X.

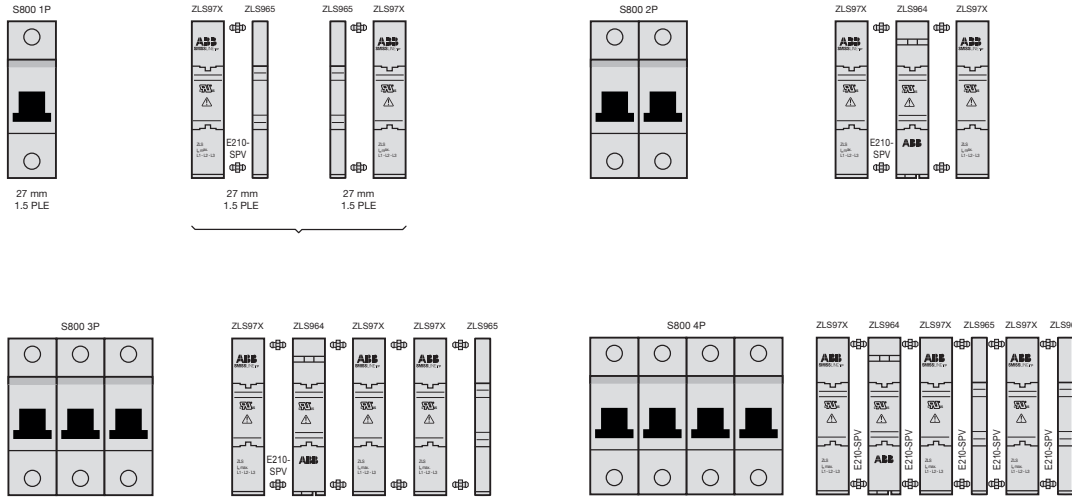

Designation	Type name	ABB IT number	EAN number 761 227	Pack-aging unit	Module	Weight in grams
9mm wide	ZLS965	2CCA180545R1001	150 1440	Set of 5	0.5	5



---

# Table of contents

<b>01. Busbar system</b>	108
<b>02. MCBs technical details S400</b>	117
<b>03. RCDs technical details F402, F404</b>	130
<b>04. OVR technical details OVR404</b>	140
<b>05. Surge and lightning protection solutions IS404</b>	141
<b>06. Auxiliary switches and signal contacts</b>	144
<b>07. Shunt trip for S400</b>	146

# Smisline TP technical details

## Busbar system 125A Overview

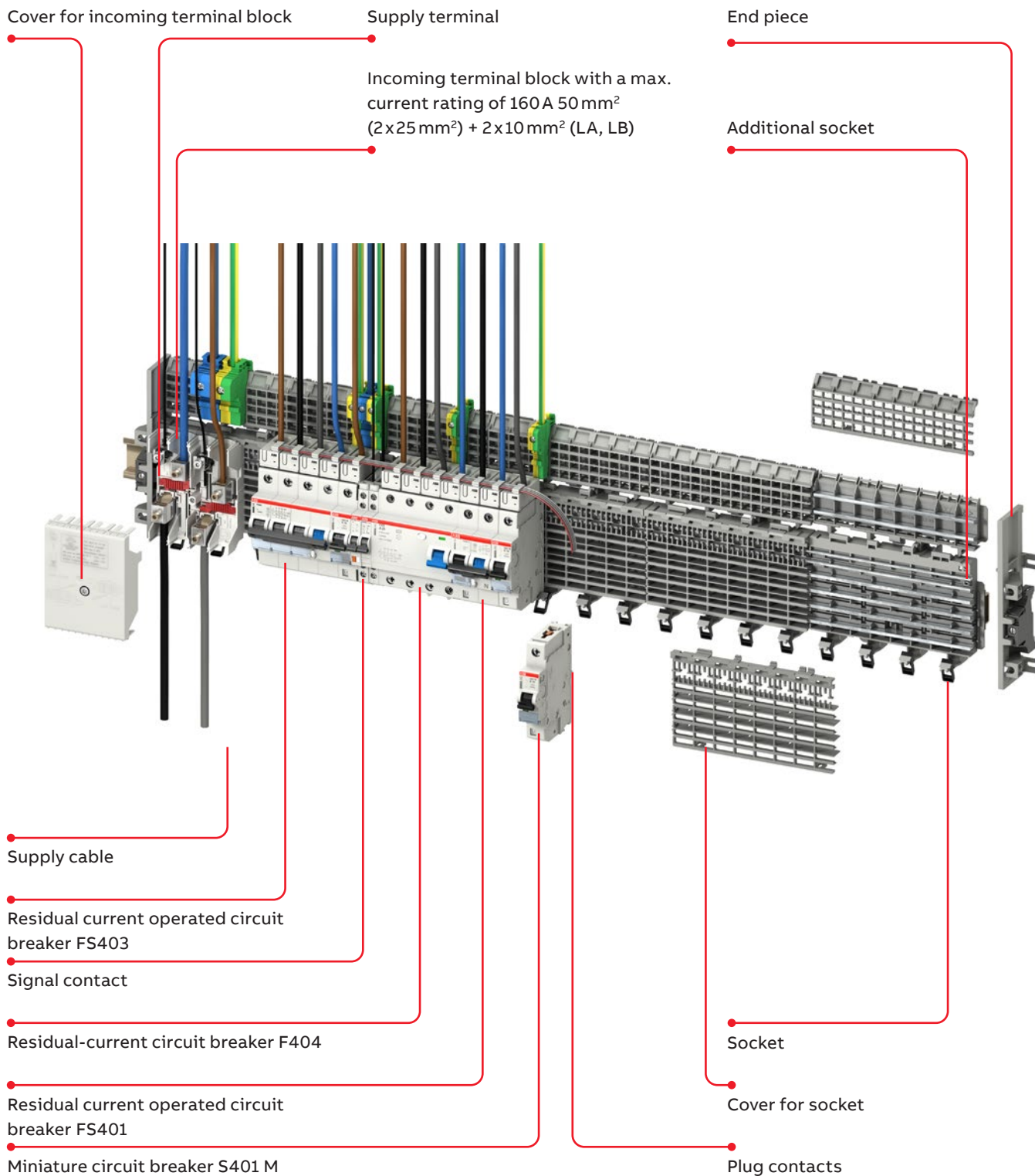

## Smissline TP technical details

### Busbar system 125 A

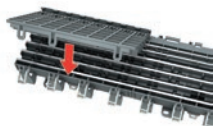

#### Socket bases ZLS906, ZLS908

The smissline socket system is a totally new kind of assembly and connection technology for the construction of distributions. Besides the classic method of snapping the devices onto 35-mm mounting rails, the new family of devices can be directly attached to the socket bases with integrated busbars. The time-consuming process of connecting up the supply is thereby no longer needed. In addition, in the event of rearrangement or expansion, the replacement of devices in existing systems is made significantly easier.

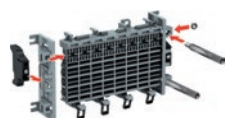

The socket sections and the wide range of accessories make it possible to plan with the capability for expansion and to construct distribution systems of any desired size in a short period of time.

6- and 8-module sockets are installed either by screwing them onto any flat surface or by snapping them onto a 35 mm DIN mounting rail. Lateral movement or detachment of the sockets again is possible before final fixing.

- to determine the required socket length, the space necessary for
- the devices required
- the incoming terminal block and
- any reserve spaces needed must be determined.

#### Snap mounting

Pull down the slide with a screwdriver until it latches (socket can be moved).

Press on front of slid:

Fixed position

(Sockets fixed)



#### The key features

- System of any desired length (even number of poles)
- Integrated busbars
- Simple device change
- Long-term planning and problem free extension possible
- Significant time savings during assembly and connection



#### Busbars for the sockets and additional socket ZLS200

The busbars of size 10x3mm can be loaded with currents up to 125A. They are plated for perfect contact with the devices plug-in contacts. The maximum available busbar length is 1979 mm. The same busbar type is used, regardless whether it is fitted in the socket (L1, L2, L3, N) or in the additional socket (N, PE). The busbars are inserted into the socket from the front.



#### Auxiliary busbars for the socket ZLS202

The 5x2mm auxiliary busbars are intended for a common power supply of auxiliary switches and signal contacts. They are also plated and their max. delivery length is 1979 mm.

Like the main busbars, the auxiliary busbars are inserted in holders LA and LB from the front. Of course, only on auxiliary busbar can be fitted.

## Smissline TP technical details

### Busbar system 125A Incoming



#### Incoming terminal blocks ZLS260 to 262

Compact terminal block with the construction width of 18 mm for 2 poles. The maximum rated current is 63A for L1, L2, L3N and 6A for LA, LB.

#### General

The incoming terminal block is used to connect cables directly to the busbars. The terminals act directly on the busbars and therefore fix the incoming terminal block. Removable terminal tops permit the connection of continuous conductors (risers) while horizontal or vertical cable entry is also possible.

Instead of using the incoming terminal block, the power supply can also be realized via a device (e.g. residual current operated circuit breaker, miniature circuit breaker or switch disconnecter).

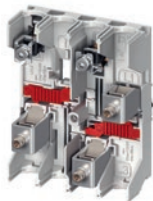

#### Incoming terminal blocks ZLS924

A standard incoming terminal block whose cover provides protection against accidental contact.

Construction height 50 mm. The base plate can be fitted with a maximum of 4 main terminals L1, L2, L3 and N for the busbars, and 2 auxiliary terminals LA and LB for the auxiliary busbars.



#### Incoming terminal block left and right

In order to prevent the cables from crossing when two sockets rows are connected it is a good solution to use a left and a right incoming block (see photo).



#### Incoming terminal component ZLS250 to 255

The incoming terminal component, with an installation width of 36 mm is available as a single-pole component for the line conductors L1, L2, L3 and as neutral. The terminals act directly on the busbars and thereby fix the incoming terminal component. The incoming terminal component, L1, L2, L3 and N can be combined to meet specific needs. A maximum cable cross-section of 95 mm<sup>2</sup> can be connected to the incoming terminal component.



#### Incoming bolt-on solution M8 50 mm<sup>2</sup> up to 150 mm or 4/0AWG up to 250 kcmil

This Incoming block can be used for side feed Incoming with 250A for IEC and UL applications. It is an bolt-on solution for a connection up to 150 mm<sup>2</sup>. For a safe and strong connection to Incoming molded case circuit breaker upstream. Can only used for the 250A Power Bar System.

## Smisline TP technical details

### Busbar system 125A Incoming IEC

—  
01 and 02 Power supply left or right, maximum 125A.

—  
03 Power supply in centre, maximum 160A. A maximum of 125A is permitted on either side. A total of 160A must not be exceeded.

—  
04 Incoming maximum 63A for this incoming block.

—  
05 Incoming terminal component, in centre, maximum 200A. But on each side not more than 125A.

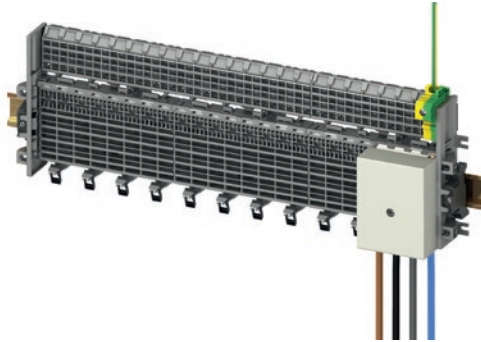

01

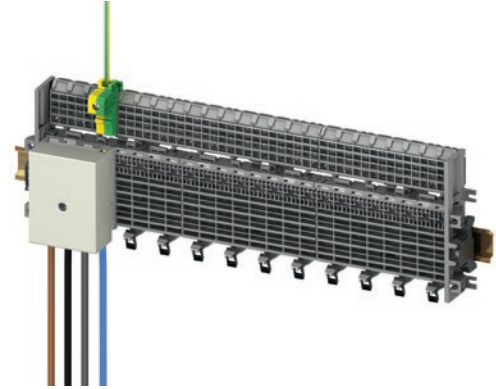

02

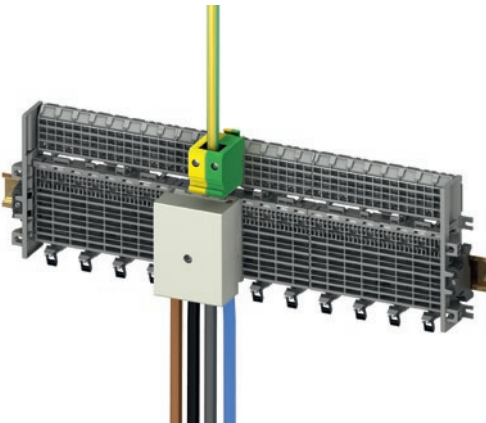

03

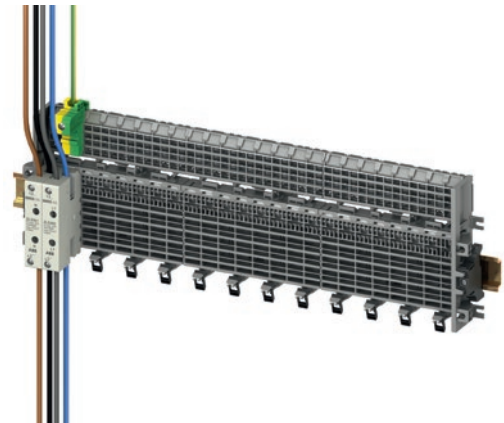

04

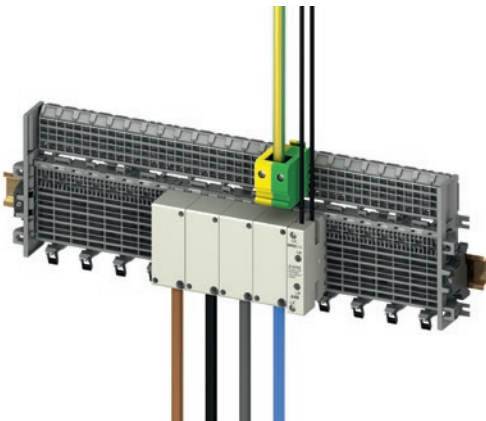

05



## Technical details

### Busbar system power supply

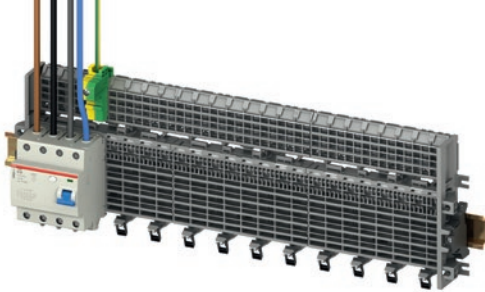

#### Indirect supply via residual current operated circuit breaker (RCCB) (or switch disconnector)

The supply cable is connected at the top of the RCCB. This supply variant gives the busbars and therefore all subsequent devices RCCB protection. If several RCCB groups are planned, the busbars should be separated and spaced using the dark grey busbar insulator ZLS938. Attention must then be paid to the regulations governing protection of the residual current circuit breaker by subsequent miniature circuit breakers. The supply can also be fed in through the switch disconnector.

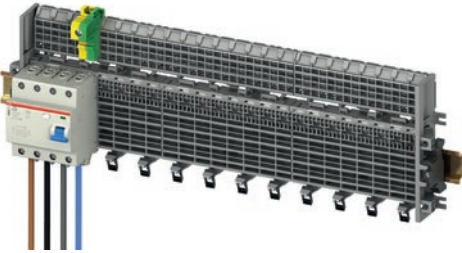

#### Direct supply to residual current operated circuit breaker (or switch disconnector)

Instead of using the incoming terminal block, the power can also be supplied via a device.

In this case, the supply cable is connected to the lower terminal of the device. The residual current operated circuit breaker or switch disconnector can be supplied with 63 A regardless of its rated current, since the plug-in connection arrangement of the device is suitable for this amount of current.

For current in excess of 63 A, the incoming terminal block or the incoming terminal component should be used.

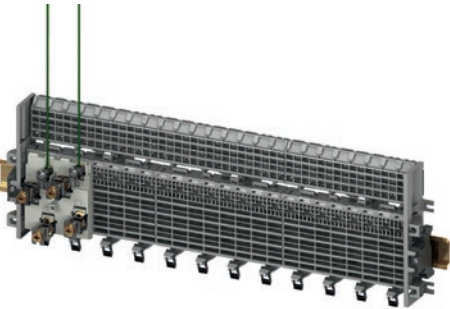

#### Supply of auxiliary busbars LA and LB

The two auxiliary busbars LA and LB can be supplied using the additional terminal ZLS 233 via an incoming terminal block. The maximum operating current of the auxiliary busbars is 40 A.

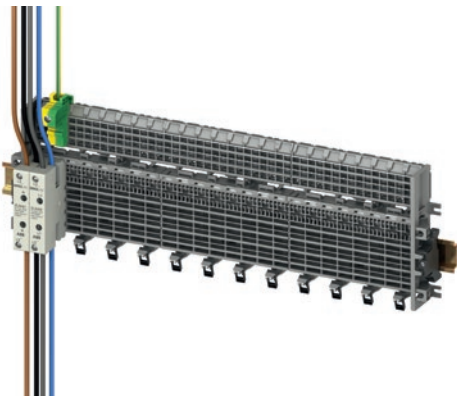

#### Incoming block for two auxiliary busbars LA, LB

The pluggable incoming block is especially for the two auxiliary busbars LA, LB. The maximum rated current is 6 A.

## Power supply SMISLINE TP Power Bar System 250 A

IEC/EN 61439-6

—  
01 Power supply side feed, (ZLSP25X, ZLSP95X) with terminals for 50 mm<sup>2</sup> up to 120 mm<sup>2</sup> flexible wire with ferrule, max. 1 wire, 10 mm<sup>2</sup> – 25 mm<sup>2</sup> two wires, 250 A

—  
02 Ring terminal solution M8, 50 mm<sup>2</sup> up to 150 mm<sup>2</sup> are possible. It is possible to run the connection cable through several SMISLINE socket rows.

—  
03 Central feed 400 A total. The cables in the connections must have the same length. For 400 A Incoming for upstream protection are two fuses or XT breaker necessary.

### Two power supply solution are possible for the 250A SMISLINE TP System:

- Solution one is the 144 mm (8PLE) wide ring terminal solution (ZLSP934). This is directly attached to the Power Bar socket ZLSP908. The connection is made via ring terminal M8. It is possible to run the connection cable through several SMISLINE socket rows.
- Solution two are the incoming terminal component (ZLSP25X, ZLSP95X) with terminals for 50 mm<sup>2</sup> up to 120 mm<sup>2</sup>

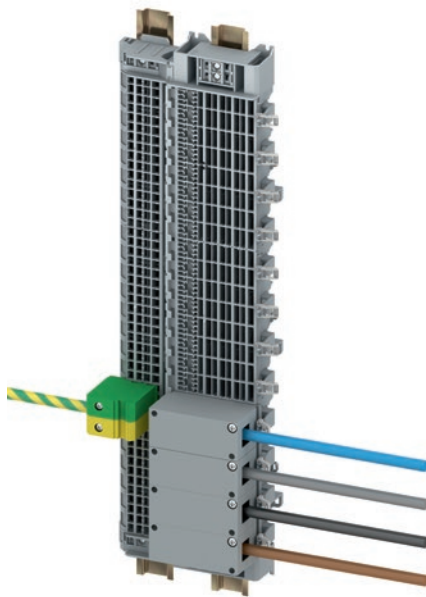

—  
01



—  
02

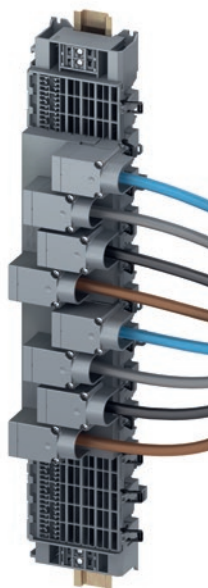

—  
03

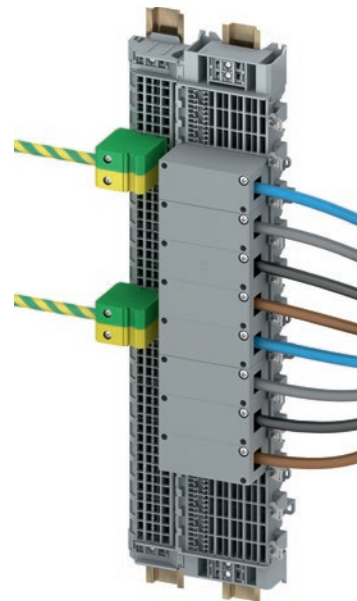

---

## Power supply SMISLINE TP Power Bar System 250 A

SMISLINE TP for UL 508 – Industrial Control Equipment

—  
01 Incoming with Incoming solution ZLSP934 bolt on M8 max. 4/0AWG – 250kcmil. 250A side feed

—  
01

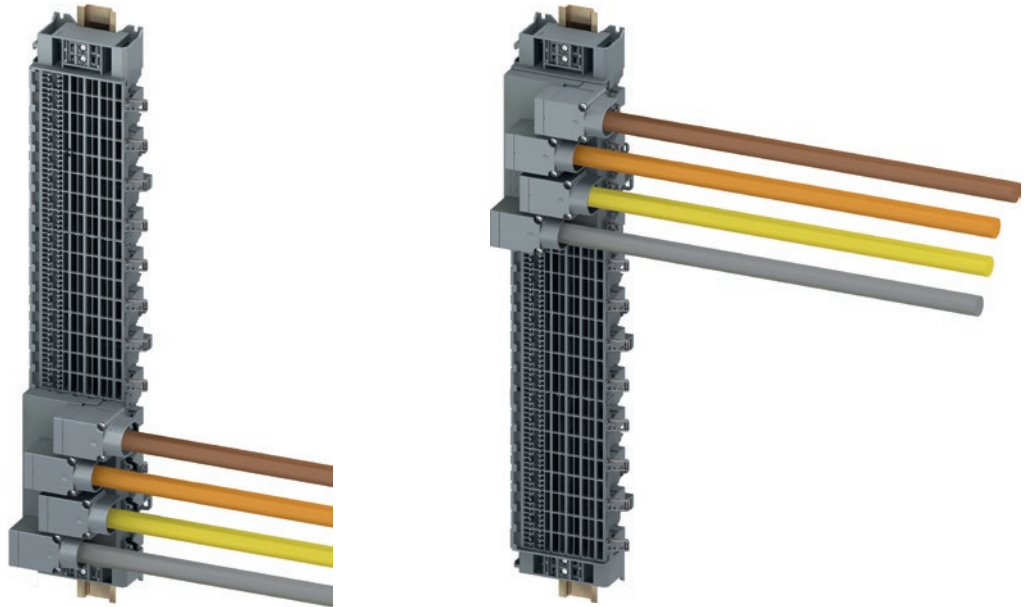

## Power supply: overload and short-circuit protection

### Overload and short-circuit protection of the plug-in socket system

#### Protection of the busbar system without upstream overcurrent protection

An important factor for the protection of the busbar system (sockets, incoming terminal block, incoming terminal component, adapter, combi module or terminals) is the characteristic of the rated peak withstand current  $I_{pk}$ . The rated peak withstand current  $I_{pk}$  of the SMISLINE busbar system is 30 kA.

#### Protection of the busbar system with upstream overcurrent protection

The rated short-circuit current  $I_{cf}$  of the SMISLINE busbar system is 50 kA. If, on the power supply side, a circuit breaker of the type Sace Tmax 200A, a high performance circuit breaker S800 or a NH fuse is positioned upstream of the busbar system, then due to the short-circuit current limiting effect of this protection device, a larger prospective short-circuit current of up to 50 kA for the plug-in socket system is permissible.

### Overload and short-circuit protection of devices on the busbar system

The rated short-circuit breaking capacity (or rated breaking capacity) of the protective devices, together with the maximum short-circuit current at the installation location of the devices on the busbar system, must be taken into consideration.

This is not only relevant for the SMISLINE busbar system, but is also applicable to the distribution construction.

#### Miniature circuit breaker

If the prospective short-circuit current at the installation location of a miniature circuit breaker is not greater than its rated breaking capacity, no back-up protection via an upstream overcurrent protection device is necessary.

If the prospective short-circuit current at the installation location of a miniature circuit breaker is greater than its rated short-circuit breaking capacity, the current ratings of the upstream overcurrent protection device must not exceed the table values in the back-up tables (catalogue, page 90 onwards).

#### Residual-current circuit breaker

A back-up fuse with max. 100A gL/gG or a high performance circuit breaker S800 100A is required for short-circuit protection upstream or downstream (see Coordination table, page 34). A back-up fuse is not required up to the level of the internal short-circuit withstand rating. Thermal protection can be ensured by means of downstream miniature circuit breakers, but only if the rated currents do not exceed the value of the current rating of the residual-current circuit breaker in consideration of a utilisation factor.

#### Surge arrester OVR

An upstream overcurrent protection device with max. 125A gL/gG is necessary for short-circuit protection (in the case of non-independent interruptions of the secondary current).

#### Back-up fuses for devices with a DIN Rail adapter

In principle, the same requirements apply as for directly plugged-in devices.

## Smisline TP technical details

### Busbar system 125A accessories



#### Socket end piece ZLS920

To prevent displacement of sockets and busbars (particular when installed vertically) end pieces can be fitted at the start and finish of each row of sockets. These simultaneously ensure electrically protected covering of the busbar end faces and mechanical fixing of the sockets on the mounting rail.



#### Intermediate piece ZLS725

The light grey intermediate piece matches the device profile and fills empty module spaces.

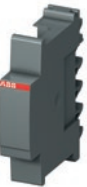

#### Busbar insulator ZLS938

The dark grey busbar insulator electrically isolates the separated busbar ends from each other (e.g. when using several RCD protected groups) and also identifies the isolation point from outside. It conforms with the device profile and its space requirement is 1 module.



#### Busbar cover ZLS100

If component modules or spare modules are not required, the busbar cover ensures electrically protected covering of the main and auxiliary busbars. The cover (4 modules) can be divided anywhere. The openings allow voltage measurements on the busbars without removing the cover.

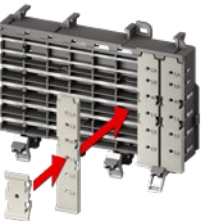

#### Extension adapter ZLS101

The extension adapter, single or several side by side, can be plugged into the busbar cover via the built-in holding device. This enables conventional DIN devices with 45 mm cap size to be snapped onto the SMISLINE socket. By plugging in several extension adapters one on top of the other, heights can be adjusted in multiples of 7 mm.

## Definitions

### **Rated short-circuit breaking capacity $I_{cn}$**

#### **According to EN 60898-1**

The maximum current which a switching device can switch off without damage at a rated operational voltage and rated operational frequency. It is specified as an effective value.

### **Rated ultimate short-circuit breaking capacity $I_{cu}$**

#### **According to EN 60947-2**

Ultimate short-circuit breaking capacity that a circuit breaker can switch off without damage at a rated operational voltage and rated operational frequency. It is specified as an effective value.

### **Rated service short-circuit breaking capacity $I_{cs}$**

#### **According to EN 60947-2**

Service short-circuit breaking capacity that a circuit breaker can switch off without damage at a rated operational voltage and rated operational frequency. It is specified as an effective value.

### **Rated insulation voltage $U_i$**

The rated insulation voltage ( $U_i$ ) is the voltage to which dielectric checks and creepage distances refer. The maximum rated operational voltage must not exceed its rated insulation voltage.

### **Rated impulse withstand voltage $U_{imp}$**

Peak of a withstand voltage of a specified form and polarity with which the circuit can be loaded under specified test conditions without a breakdown and to which clearances relate.

The rated impulse withstand voltage must be equal to or greater than the values of the withstand over-voltages (transient overvoltages) which occur in the system in which the device is used.

### **Rated short-time withstand current $I_{cw}$**

The rated short-time withstand current is the effective value of the short-circuit current, as specified by the manufacturer for this circuit, that the circuit can conduct without damage. Unless otherwise specified, a time of 1s shall apply.

### **Rated conditional short-circuit current $I_{cc}$**

The rated conditional short-circuit current is the value of the prospective short-circuit current, as specified by the manufacturer, for a switching device combination that the latter can conduct during the total break time. The information about the specified short-circuit device must be given by the manufacturer.

### **Rated fused short-circuit current $I_{cf}$**

The rated fused short-circuit current is the conditional rated short-circuit current if the short-circuit device is a fuse in accordance with IEC 60269 [IEV 441-17-21, modified].

### **Rated peak withstand current $I_{pk}$**

The rated peak withstand current is the peak value of the withstand current of the circuit of a combination of switching devices, as specified by the manufacturer.

### **Back-up protection**

Assignment of two overcurrent protective devices in series, where the protective device, generally but not necessarily on the supply side, effects the overcurrent protection with or without the assistance of the other protective device and prevents excessive stress on the latter [IEC 60947-1, definition 2.5.24].

### **Total selectivity**

Overcurrent discrimination where, in the presence of two overcurrent protective devices in series, the protective device on the load side effects the protection without causing the other protective device to operate [IEC 60947-2, definition 2.17.2].

### **Partial selectivity**

Overcurrent discrimination where, in the presence of two overcurrent protective devices in series, the protective device on the load side effects the protection up to a given level of overcurrent, without causing the other protective device to operate [IEC 60947-2, definition 2.17.3].

# Miniature circuit breaker (MCB) Properties

### General Information

The SMISLINE miniature circuit-breaker is an energy-restricting circuit-breaker that has high performance values and that is equally suitable for the industrial sector, for commercial use and for installation at home.

If a short-circuit occurs, it guarantees excellent selectivity conditions to upstream overcurrent circuit breakers while the load on equipment that is connected downstream is limited to a minimum amount.

### The most important features

- High rated breaking capacity of 6 kA and 10 kA acc. IEC/EN60989-1 and 25 kA, 30 kA and 40 kA acc. IEC/EN 60947-2
- Optimum ease of installation and connection
- The pole conductors are protected against accidental contact
- Tripping characteristic on B, C, D, K, UCZ/UCC

### Miniature circuit-breaker in accordance with standard EN 60898-1

This standard is for electrical installation material for household installations and for similar purposes. It regulates the use of miniature circuit-breakers by the layman up to a maximum of 125 A, a voltage of 440 VAC and up to a maximum of 25 kA.

### Miniature circuit-breaker in accordance with standard EN60947-2

This standard is for low-voltage material used for industrial purposes. It regulates the use of circuit-breakers (and not miniature circuit-breakers) by qualified personnel up to a maximum voltage of 1000 VAC or 1500 VDC. This standard does not recognise any maximum values when it comes to current and breaking capacity. In practice, the standard is also applied to miniature circuit-breakers.

### Miniature Circuit Breaker SUP400 for branch circuit protection acc. to UL 489 File E312425

The miniature circuit breaker SUP400 is ABB's solution for UL 489 branch circuit protection up to 480Y/277V AC. This circuit breaker is an all-round device applications for universal use in North American and global markets due to its approvals according standards UL489.

### Brief description of tripping

The SMISLINE miniature circuit breakers have a current-limiting operation. They have two different releases acting on the mechanism.

1. Thermal release, operating with a time delay, for overload protection
2. Electro-magnetic release plunger operated for short-circuit protection.

They offer: – high short-circuit breaking capacity  
– high selectivity to the back-up fuse  
– In the event of short-circuits, low electrodynamic and heating effects on the cable and the point of fault location due to the drastically limited let through energy  $\int i^2 dt$ .

### Oscillogram of a short-circuit current interruption

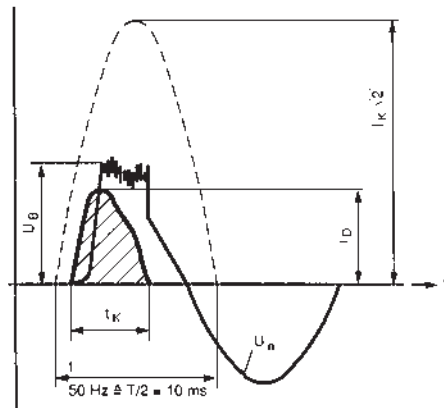

- $i_k \cdot \sqrt{2}$  = peak value of prospective short-circuit current
- $i_o$  = Max. peak let through current of circuit breaker S 400
- $U_n$  = Supply voltage
- $U_a$  = Arc voltage of circuit breaker
- $t_k$  = Total interruption time



1 N  
S200A100100001



1 N  
2 N  
S200A100100001



1 N  
2 N  
3 N  
S200A100100001



1 N  
2 N  
3 N  
4 N  
S200A100100001



1 N  
2 N  
3 N  
4 N  
5 N  
7 N  
8 N  
S200A100100001

# MCBs technical details

## Trip characteristics

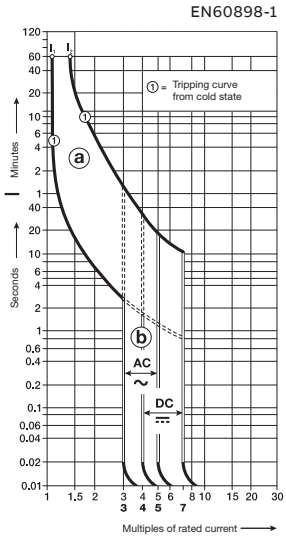

**Trip characteristics: B**  
 Thermal trip  
 1.13...1.45 x I<sub>n</sub>  
 Electromagnetic trip  
 3...5 x I<sub>n</sub> AC  
 4...7 x I<sub>n</sub> DC  
 Calibration temperature 30°C

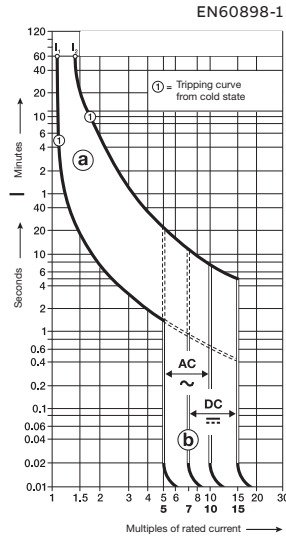

**Trip characteristics: C**  
 Thermal trip  
 1.13...1.45 x I<sub>n</sub> acc. to EN60898-1  
 Thermal trip  
 1.05...1.3 x I<sub>n</sub> acc. to EN60947-2  
 Electromagnetic trip  
 5...10 x I<sub>n</sub> AC  
 7...14 x I<sub>n</sub> DC  
 Calibration temperature 30°C

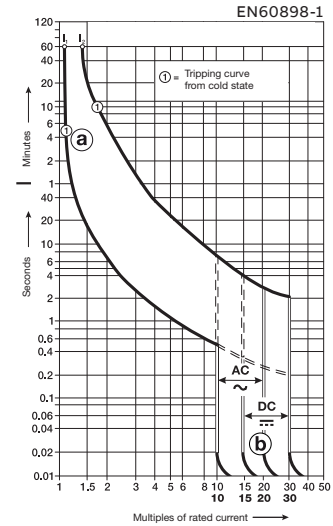

**Trip characteristics: D**  
 Thermal trip  
 1.13...1.45 x I<sub>n</sub>  
 Electromagnetic trip  
 10...20 x I<sub>n</sub> AC  
 15...30 x I<sub>n</sub> DC  
 Calibration temperature 30°C

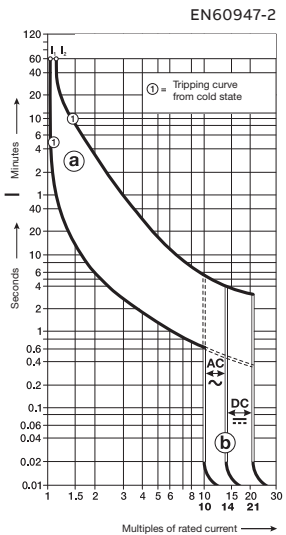

**Trip characteristics: K**  
 Thermal trip  
 1.05...1.3 x I<sub>n</sub>  
 Electromagnetic trip  
 10...14 x I<sub>n</sub> AC  
 14...20 x I<sub>n</sub> DC  
 Calibration temperature 40°C

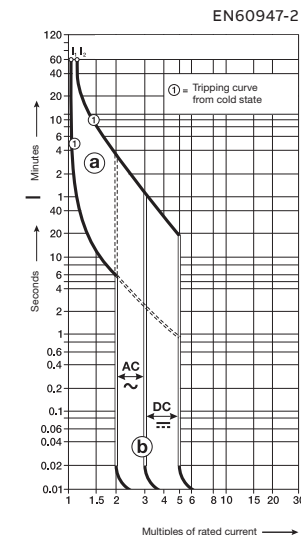

**Trip characteristics: UC**

Z	C
1.05...1.35 x I <sub>n</sub>	1.13...1.35 x I <sub>n</sub>
3...5 x I <sub>n</sub> DC	7...14 x I <sub>n</sub> DC
2...3 x I <sub>n</sub> AC	5...10 x I <sub>n</sub> AC

Calibration temperature 40°C

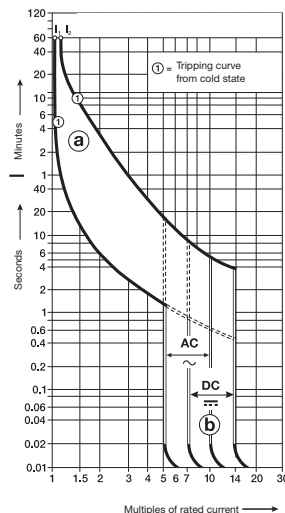



## MCBs technical details

### Trip characteristics

#### Trip characteristics example of trip curve interpretation of B-characteristics

**a Thermal trip characteristics:**

Lower test current  $I_1$  = defined as non-tripping current.  
 The circuit breaker withstands 1.13 times the rated current for at least 60 minutes.  
 Upper test current  $I_2$  = defined as trip current.  
 The circuit breaker trips at 1.45 times the rated current within 60 minutes.

**b Electro-magnetic trip characteristics AC:**

The circuit breaker withstands 3 times the rated current for more than 0.1 sec. (in this example, up to around 2 sec.).  
 The circuit breaker trips in less than 0.1 sec. at 5 times the rated current.

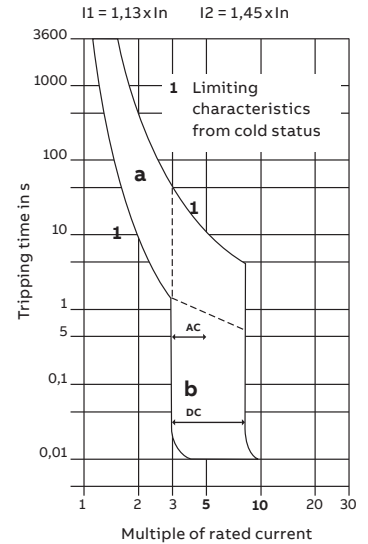

#### Trip behaviour of different trip characteristics

Trip characteristics and current ratings	Thermal release			Electromagnetic release		
	Test currents: lower $I_1$	upper test current $I_2$	Trip time	Test currents: lower test current	upper test current	Trip time
B 4 to 63A	$1.13 \times I_n$	$1.45 \times I_n$	> 1 h < 1 h	$3 \times I_n$	$5 \times I_n$	> 0.1 s < 0.1 s
C 0.5 to 63A	$1.13 \times I_n$	$1.45 \times I_n$	> 1 h < 1 h	$5 \times I_n$	$10 \times I_n$	> 0.1 s < 0.1 s
D 6 to 63A	$1.13 \times I_n$	$1.4 \times I_n$	> 1 h < 1 h	$10 \times I_n$	$20 \times I_n$	> 0.1 s < 0.1 s
K 0.5 to 63A	$1.05 \times I_n$	$1.2 \times I_n$	> 2 h < 2 h	$10 \times I_n$	$14 \times I_n$	> 0.2 s < 0.2 s
		$1.5 \times I_n$	< 2 min			
		$6.0 \times I_n$	> 2 s			

**Application characteristics: B**

Miniature circuit breaker for circuits supplying loads generating no or only minor inrush currents (boilers, electric heaters, cookers).

**Application characteristics: C**

The 'standard' miniature circuit breaker for circuits supplying loads producing inrush currents particular to inductive loads (TV sets, fluorescent and discharge lamps) and for socket outlets.

**Application characteristics: D**

Miniature circuit breaker for circuits supplying loads producing very high inrush currents (transformers, capacitor banks).  
 Main circuit breaker for the back-up protection of downstream connected circuit breakers.

**Application characteristics: K**

Circuit breaker for equipment: The characteristics of these types enable the close protection requirements for equipment to be met.

**Application characteristics: UC**

Device protection in DC systems of up to 250V = with a time constant of <15ms (emergency networks, electroplating, etc.).

## MCBs technical details

### Internal resistances at rated voltage and power losses

Internal resistances and power loss per pole (cold resistance at room temperature)

#### S400E, S400M

B, C tripping characteristics

$I_n$ [A]	$R_i$ [mΩ]	$P_v$ [W]
0.5	5023	1.3
1	1424	1.4
1.6	677	1.7
2	338	1.4
3	146	1.3
4	109	1.7
6	50	1.8
8	22	1.4
10	17	1.7
13	12	2.0
16	8.4	2.2
20	5.1	2.0
25	3.9	2.4
32	3.1	3.2
40	2.3	3.7
50	1.5	3.8
63	1.4	5.6

#### S400M-UC

C, Z tripping characteristics

$I_n$ [A]	$R_i$ [mΩ]	$P_v$ [W]
0.5	8173	2.0
1	2174	2.2
1.6	1039	2.7
2	521	2.1
3	235	2.1
4	132	2.1
6	67	2.4
8	29	1.8
10	20	2.0
13	15	2.5
16	10	2.6
20	5.6	2.2
25	4.3	2.7
32	3.7	3.8
40	2.6	4.2
50	1.7	4.2
63	1.4	5.6

#### S400E, S400M

D, K tripping characteristics

$I_n$ [A]	$R_i$ [mΩ]	$P_v$ [W]
0.5	4419	1.1
1	1311	1.3
1.6	627	1.6
2	326	1.3
3	135	1.2
4	85	1.4
6	46	1.7
8	20	1.3
10	16	1.6
13	11	1.9
16	7.8	2.0
20	5.0	2.0
25	3.8	2.4
32	3.0	3.1
40	2.3	3.7
50	1.5	3.8
63	1.4	5.6

#### S400P, SUP400M

B, C, K tripping characteristics

$I_n$ [A]	$R_i$ [mΩ]	$P_v$ [W]
2	333	1.3
3	137	1.2
4	83	1.3
5	45	1.1
6	45	1.6
8	19	1.2
10	13	1.3
13	10	1.7
15	7.6	1.7
16	7.6	1.9
20	5.0	2.0
25	3.7	2.3
30	3.0	2.7
32	2.9	3.0
35	2.9	3.6
40	2.3	3.6
50	1.5	3.7
63	1.4	5.5

## MCBs technical details

### Pulse triggering

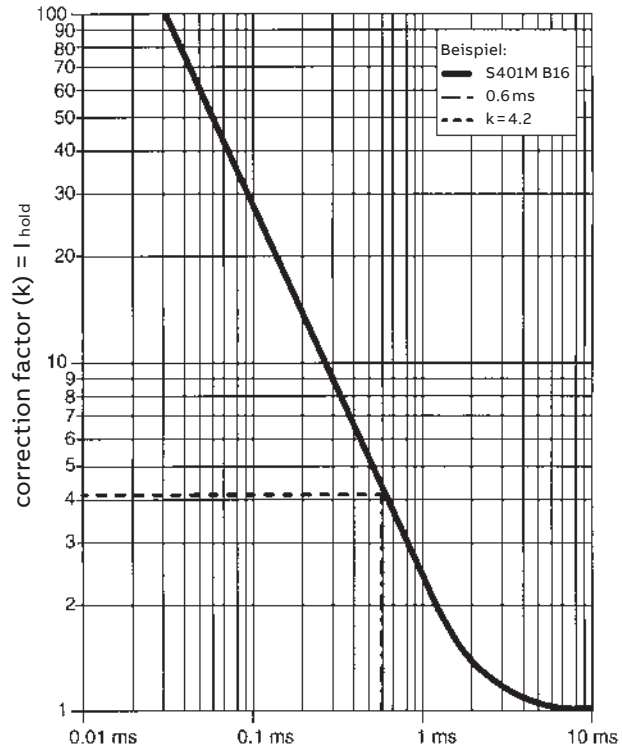

**Example 1:** Non tripping  
(Electromagnetic tripping)

S 401-B16

$$I_{\text{hold}} = k \times \text{non tripping}$$

$$I_{\text{hold}} = 4,2 \times 3 \times 16$$

$$I_{\text{hold}} = 201,6 \text{ A}$$

$$\text{B-Characteristic} = 3 \times I_n$$

$$\text{C-Characteristic} = 5 \times I_n$$

$$\text{K-Characteristic} = 10 \times I_n$$

$$\text{Z-Characteristic} = 2 \times I_n$$

The MCB S 401-B16 hold is keeping by an Impulse of 0.6ms up to a current of 201.6A.

**Example 2:**

S 401-K25

$$I_{\text{hold}} = k \times \text{non tripping}$$

$$I_{\text{hold}} = 4,2 \times 10 \times 25$$

$$I_{\text{hold}} = 1050 \text{ A}$$

The MCB S 401-K25 is keeping by an Impulse of 0.6ms up to a current of 1050A.

## MCBs technical details

### Limitation of specific let-through energy $I^2t$ 240/415V

#### $I^2t$ diagrams - Specific let-through energy value $I^2t$

The  $I^2t$  curves give the values of the specific let-through energy expressed in  $A^2s$  (A=amps; s=seconds) in relation to the perspective short-circuit current ( $I_{rms}$ ) in kA.

#### S400M; B, C, D, K

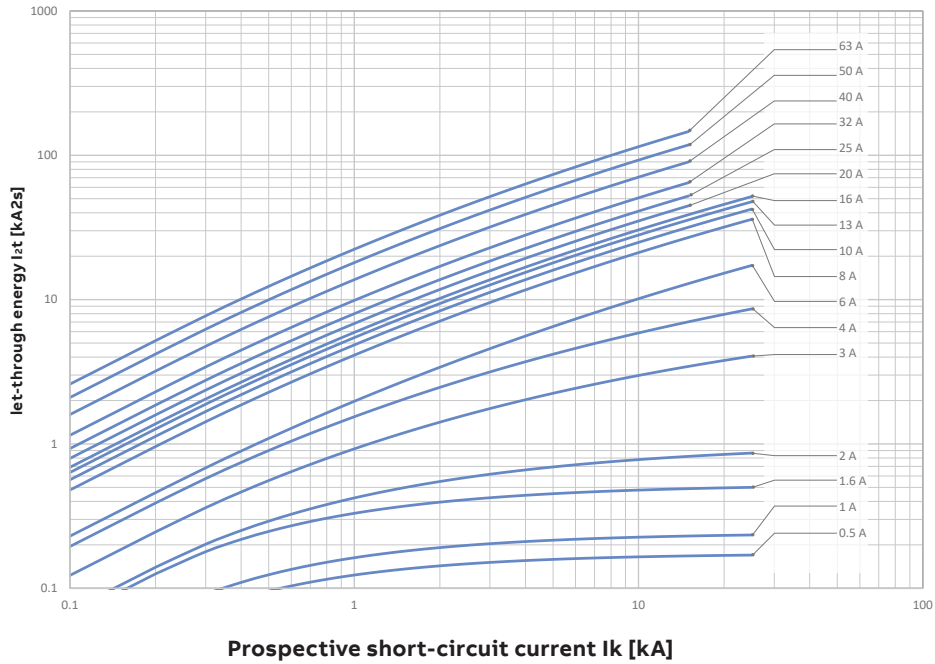

#### S400UC, S400UCZ

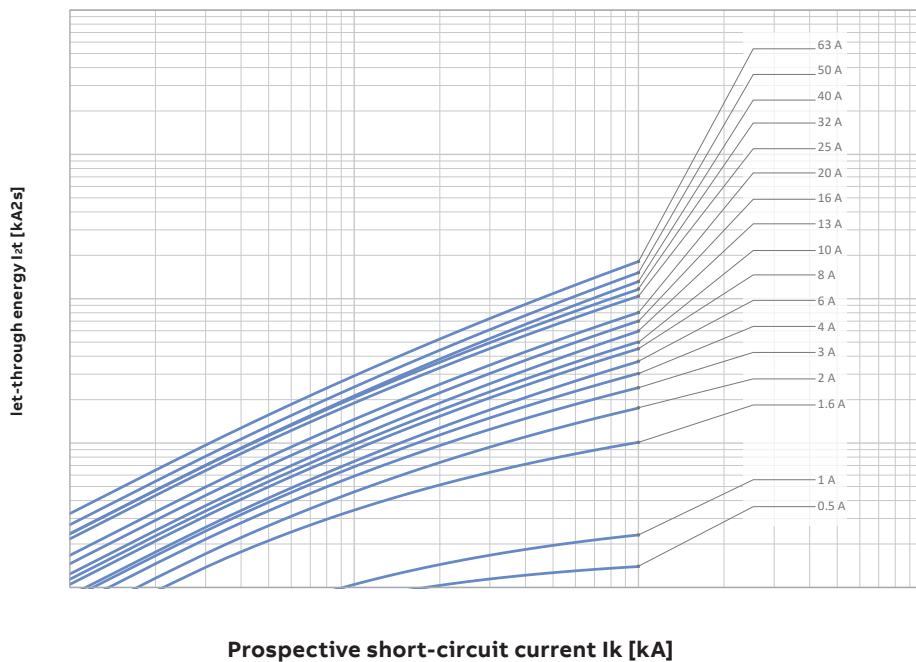

## MCBs technical details

Limitation of specific let-through energy  $I^2t$  240/415V

S400P; B, C, K, SUP400

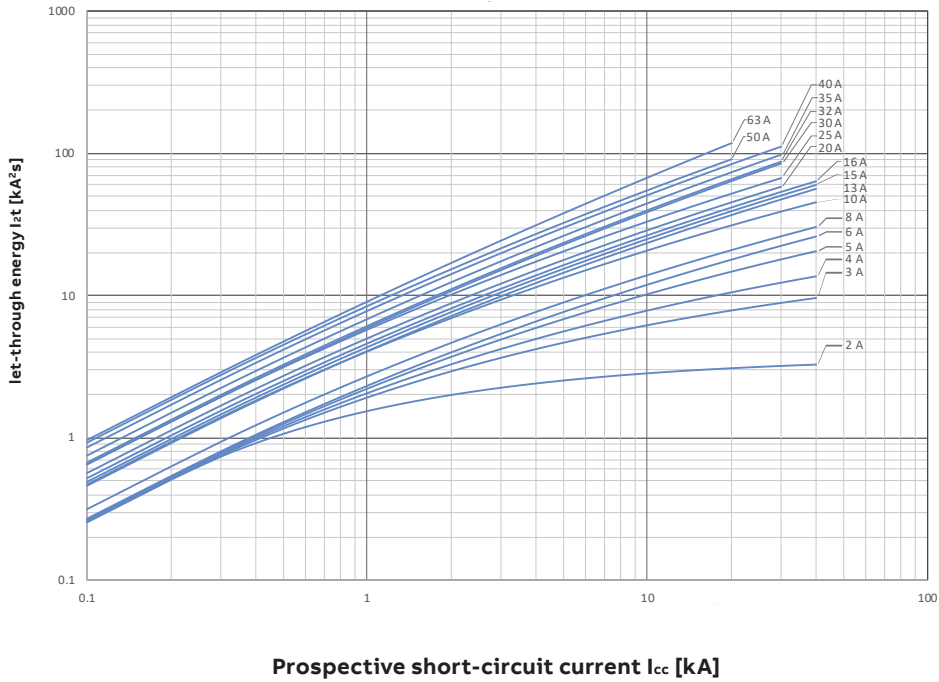

## MCBs technical details

Peak current  $I_p$  240/415 V

### Limitation curves – Peak current values

The  $I_p$  curves give the values of the peak current, expressed in kA, in relation to the prospective symmetrical short-circuit current (kA).

#### S400M; B, C, D, K

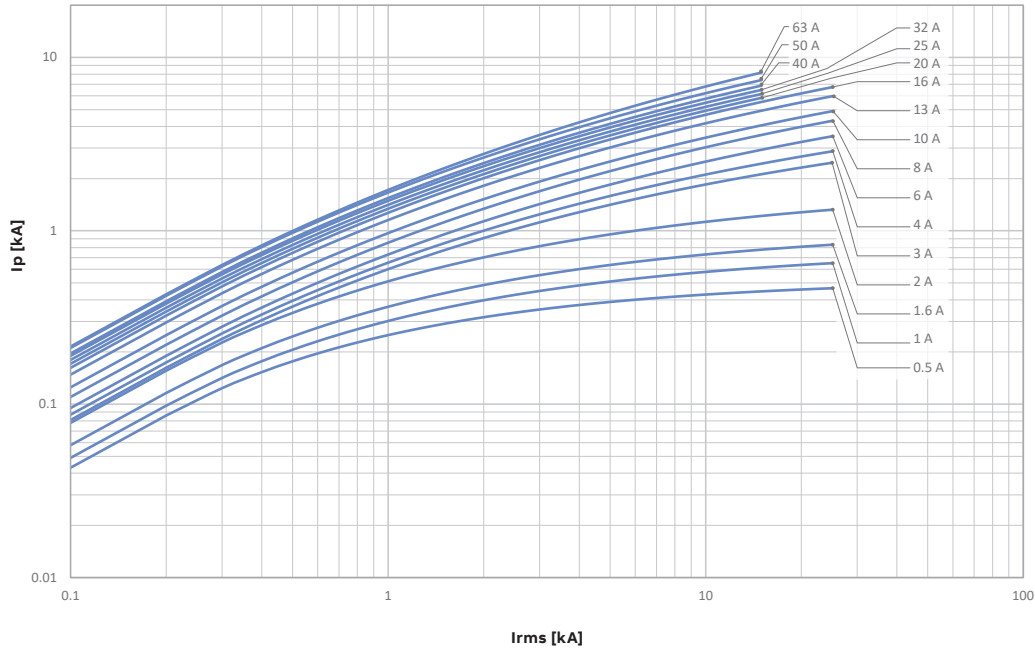

Prospective short-circuit current  $I_k$  [kA]

#### S400UC, S400UCZ

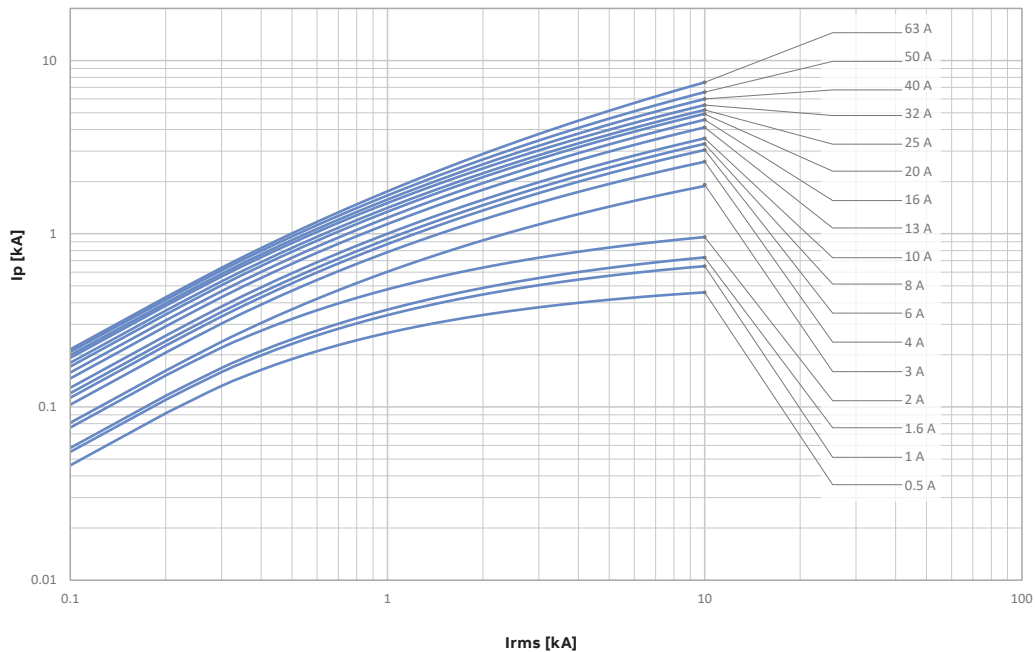

Prospective short-circuit current  $I_k$  [kA]

## MCBs technical details

Limitation of specific let-through energy  $I^2t$  240/415V

### Limitation curves – Peak current values

The  $I_p$  curves give the values of the peak current, expressed in kA, in relation to the perspective symmetrical short-circuit current (kA).

**S400P; B ,C, K, SUP400**

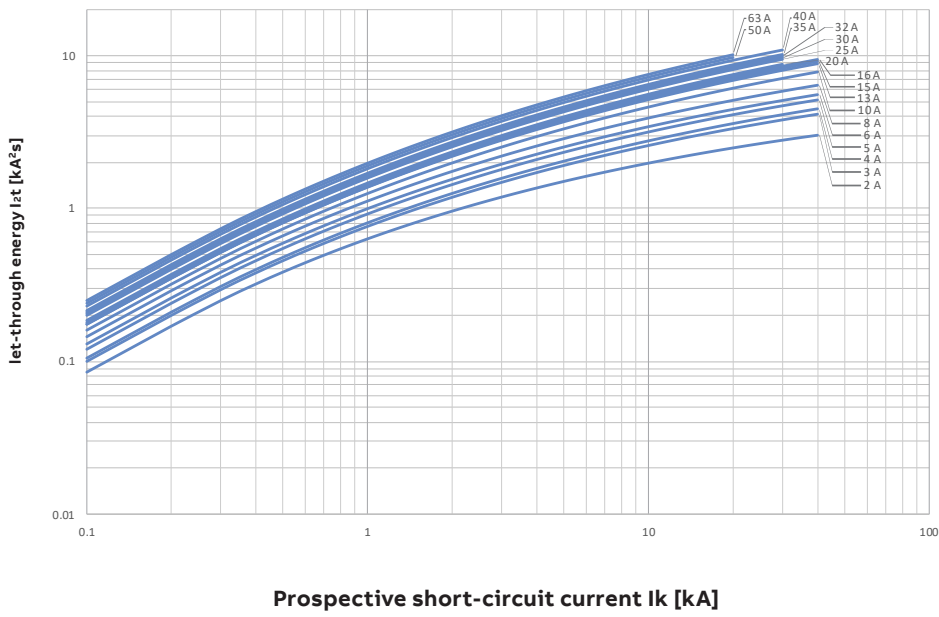

## MCBs technical details

### Performances at different ambient temperatures

#### Allowable current of miniature circuit breakers depending on ambient temperature and max. load current for row mounted miniature circuit breakers.

##### Practical procedure

Conditions often arise which allow for simple consideration of the ambient temperature and thermal influences of row mounted circuit breakers according to IEC/EN 60898 and IEC/EN 60947-2. The following procedure has proven to be effective:

1. Selection of circuit breaker according to the rated current of the equipment or the current carrying capacity of the cable depending on which of these is the lower value.
2. Consideration of thermal factors
  - for an ambient temperature
  - for thermal influence of row mounted circuit breakers
3. This results in the rated current of the circuit breaker to be selected for the relevant current

This procedure considers all thermal influence factors and results in an optimum choice of the rated current for the circuit breaker.

#### Basis for the simplified procedure

##### 1. Different ambient temperature

The thermal releases are set to a reference ambient temperature. For trip characteristic K, this is 40°C, for trip characteristics B, C and D, this is 30°C. At different ambient temperatures, the specified current values.

##### 2. Influence of row mounted devices at continuous load

If the circuit breakers are lined up close to one another and have equally high load levels, a correction factor must be taken. This influence can be reduced if fillers and/or spacers (9 mm wide) are used.

#### Influence of adjacent devices Correction factor Fm

Number of adjacent poles	Fm
1	1
2	0.95
3	0.9
4	0.86
5	0.82
6	0.8
7	0.78
8	0.77
9	0.76
<9	0.76



## MCBs technical details

### Influence of ambient temperature

Max. operating currents depending on ambient temperature for S400E, S400M, S400M-UC, S400P miniature circuit breakers  
B, C, D and Z tripping characteristics

I <sub>n</sub> (A)	Ambient temperature T (°C)											
	0	10	15	20	25	30*	35	40	45	50	55	60
0.5	0.58	0.55	0.53	0.52	0.51	0.5	0.48	0.47	0.46	0.44	0.43	0.42
1	1.15	1.09	1.07	1.04	1.02	1.0	0.97	0.94	0.91	0.89	0.86	0.83
1.6	1.85	1.75	1.71	1.67	1.63	1.6	1.55	1.50	1.46	1.42	1.38	1.34
2	2.31	2.19	2.13	2.08	2.03	2.0	1.93	1.88	1.83	1.77	1.72	1.67
3	3.50	3.32	3.24	3.16	3.09	3.0	2.93	2.85	2.77	2.69	2.61	2.53
4	4.60	4.37	4.27	4.17	4.07	4.0	3.86	3.76	3.66	3.56	3.45	3.34
6	6.90	6.59	6.44	6.29	6.14	6.0	5.83	5.68	5.53	5.37	5.22	5.07
8	9.20	8.84	8.63	8.42	8.22	8.0	7.81	7.60	7.39	7.19	6.98	6.77
10	11.50	10.90	10.70	10.40	10.20	10.0	9.65	9.39	9.14	8.88	8.63	8.38
13	15.00	14.40	14.00	13.70	13.30	13.0	12.70	12.30	12.00	11.60	11.30	11.00
16	18.50	17.60	17.20	16.80	16.40	16.0	15.60	15.20	14.70	14.30	13.90	13.50
20	23.10	22.10	21.60	21.00	20.50	20.0	19.50	19.00	18.50	18.00	17.50	17.00
25	28.90	27.50	26.90	26.30	25.60	25.0	24.30	23.70	23.00	22.40	21.80	21.20
32	37.00	35.30	34.50	33.70	32.80	32.0	31.20	30.40	29.50	28.70	27.90	27.10
40	46.20	44.10	43.00	42.00	41.00	40.0	39.00	37.90	36.90	35.90	34.90	33.90
50	57.70	55.00	53.70	52.40	51.10	50.0	48.60	47.30	46.00	44.70	43.40	42.10
63	72.70	69.30	67.70	66.10	64.50	63.0	61.30	59.70	58.10	56.40	54.80	53.20

\* Reference ambient air temperature for overload tripping

Max. operating currents depending on ambient temperature for S400M, SUP400M miniature circuit breakers  
K tripping characteristic

I <sub>n</sub> (A)	Ambient temperature T (°C)											
	0	10	15	20	25	30	35	40*	45	50	55	60
0.5	0.68	0.65	0.63	0.60	0.58	0.55	0.53	0.5	0.45	0.43	0.42	0.41
1	1.16	1.14	1.12	1.09	1.07	1.05	1.02	1.0	0.96	0.94	0.91	0.88
1.6	1.89	1.85	1.81	1.77	1.73	1.70	1.65	1.6	1.56	1.52	1.48	1.44
2	2.35	2.29	2.23	2.18	2.13	2.10	2.03	2.0	1.93	1.87	1.82	1.77
3	3.56	3.48	3.40	3.32	3.25	3.20	3.09	3.0	2.93	2.85	2.77	2.69
4	4.68	4.58	4.48	4.38	4.28	4.20	4.07	4.0	3.87	3.77	3.66	3.55
5	6.06	5.91	5.76	5.61	5.46	5.30	5.15	5.0	4.85	4.69	4.54	4.39
6	7.06	6.91	6.76	6.61	6.46	6.30	6.15	6.0	5.85	5.69	5.54	5.39
8	9.45	9.24	9.03	8.82	8.62	8.40	8.21	8.0	7.79	7.59	7.38	7.17
10	11.80	11.50	11.20	11.00	10.70	10.50	10.20	10.0	9.69	9.43	9.18	8.93
13	15.50	15.10	14.70	14.40	14.00	13.70	13.40	13.0	12.70	12.30	12.00	11.70
15	17.80	17.40	17.00	16.60	16.20	15.80	15.40	15.0	14.60	14.20	13.80	13.40
16	18.80	18.40	18.00	17.60	17.20	16.80	16.40	16.0	15.60	15.20	14.80	14.40
20	23.50	23.00	22.50	22.00	21.50	20.90	20.40	20.0	19.40	18.90	18.40	17.90
25	29.50	28.90	28.30	27.60	27.00	26.30	25.70	25.0	24.40	23.80	23.10	22.40
30	35.70	34.90	34.10	33.30	32.40	31.60	30.80	30.0	29.10	28.30	27.50	26.70
32	37.70	36.90	36.10	35.30	34.40	33.60	32.80	32.0	31.10	30.30	29.50	28.70
35	44.80	43.40	42.00	40.60	39.20	37.80	36.40	35.00	33.60	32.20	30.80	29.40
40	47.30	46.20	45.10	44.10	43.10	42.10	41.10	40.0	39.00	38.00	37.00	36.00
50	59.00	57.70	56.40	55.10	53.80	52.50	51.30	50.0	48.70	47.40	46.10	44.80
63	74.10	72.50	70.90	69.30	67.70	66.10	64.50	63.0	61.30	59.60	58.00	56.40

\* Reference ambient air temperature for overload tripping

## MCBs technical details

### Use of MCBs in direct current circuits

#### Protection of circuits with fluorescent lamps

The following table gives the maximum permissible number of fluorescent lamps which can be protected by a single-pole circuit breaker of characteristic. The figure for multi-pole circuit breakers is reduced by 20%.

A standard miniature circuit breaker type S400 M can be used in a DC system by observing the following conditions: Single pole miniature circuit breaker max. 72VDC. 2-pole miniature circuit breaker with 2-poles in series max. 125V DC. The polarity needs not to be taken into account. Load connection can either be at the top or at the bottom of the MCB.

#### Example of permissible DC voltages depending on the number of poles and the circuit configuration in earthed DC systems:

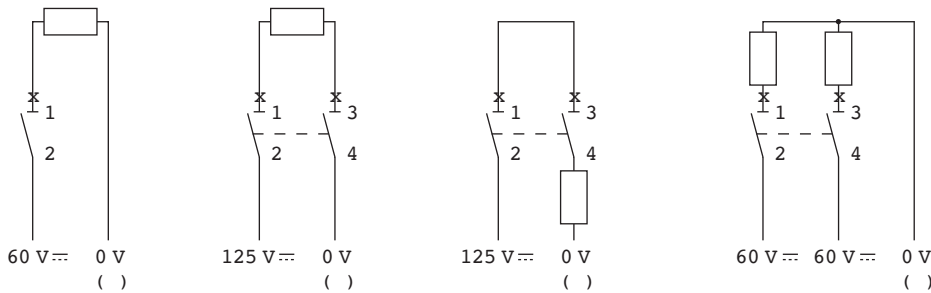

#### Examples for different voltages between a conductor and earth where voltages between conductors are identical:

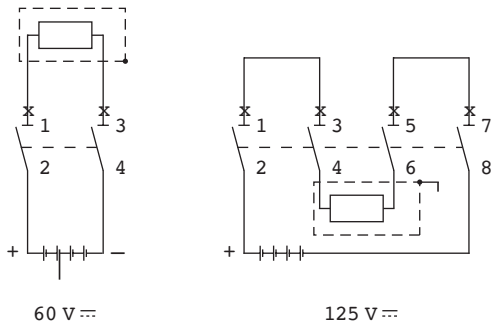

## MCBs technical details

### S400UC

**UC = Universal Current = AC/DC**

S400UC MCBs can be used in the one-pole version as 250Vd.c., and in the 2-pole version with series connection of two poles up to 440Vd.c..

**For DC incoming supply from above**

S400 UC-... MCBs have, in the area of arc chutes, permanent magnets, it is therefore necessary to take into account the polarity during the installation process. Doing so ensures that in the case of a short circuit the magnetic field of the permanent magnets corresponds with the electromagnetic field of the short-circuit current, therefore safely leading the short circuit into the arc chute. Incorrect polarities may cause damage to the MCB.

**This is why – in the case of top-fed devices – terminal 1 must be connected to (-) and terminal 3 (+).**

**Example for permissible voltages between the conductors depending on the number of poles and circuit layout:**

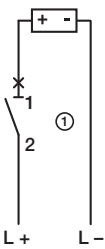
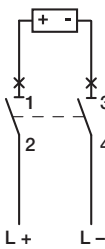
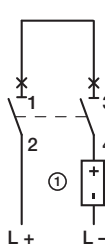
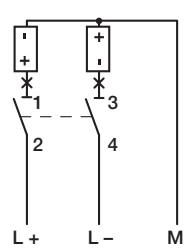
voltage $U_N$ between conductors	250Vd.c.	440Vd.c.	440Vd.c.	440Vd.c.
voltage $U_N$ between conductor and earth	250Vd.c.	250Vd.c.	440Vd.c.	250Vd.c.
supply				

# RCDs technical details

## Properties

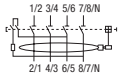

Type A

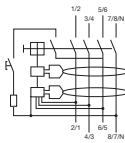

Type B

### General information about residual current operated circuit breakers

The residual current operated circuit breaker prevents personal injury and damage to property caused by electric current. Use of this circuit breaker is required in various national and international standards for electrical installations.

Modern residual current operated circuit breakers respond to small residual currents. Interruption occurs in a fraction of a second even before a hazardous situation for people, animals and property can arise.

The principle of magnetic tripping independent of the supply voltage ensures perfect and safe operation even in the event of undervoltage and neutral interruptions.

### The key features

- High short-circuit resistance 10 kA
- Sensitive for alternating and pulsating DC residual currents
- 2- and 4-pole types
- Nominal residual trip currents 10, 30, 100, 300 mA
- Snap-on auxiliary switches and signal contacts
- Nominal currents 25, 40, 63 A
- Double terminals

According to the wave form of the earth leakage currents they are sensitive to, the RCDs may be classed as:

- AC type (for alternating current only) AC are not in the Smisline portfolio
- A type (for alternating and/or pulsating current with DC components)
- B type (for alternating and/or pulsating current with DC components and continuous fault current).

### Selectivity

RCDs raise similar issue to those surrounding the installation of MCBs, and in particular the need to reduce to a minimum the parts of the system out of order in the event of a fault.

For RCBOs the problem of selectivity in the case of short-circuit currents may be handled with the same specific criteria as for MCBs.

However, for correct residual current protection, the more important aspects are linked to tripping times. Protection against contact voltages is only effective if the maximum times indicated on the safety curve are not exceeded.

# RCDs technical details

## Properties





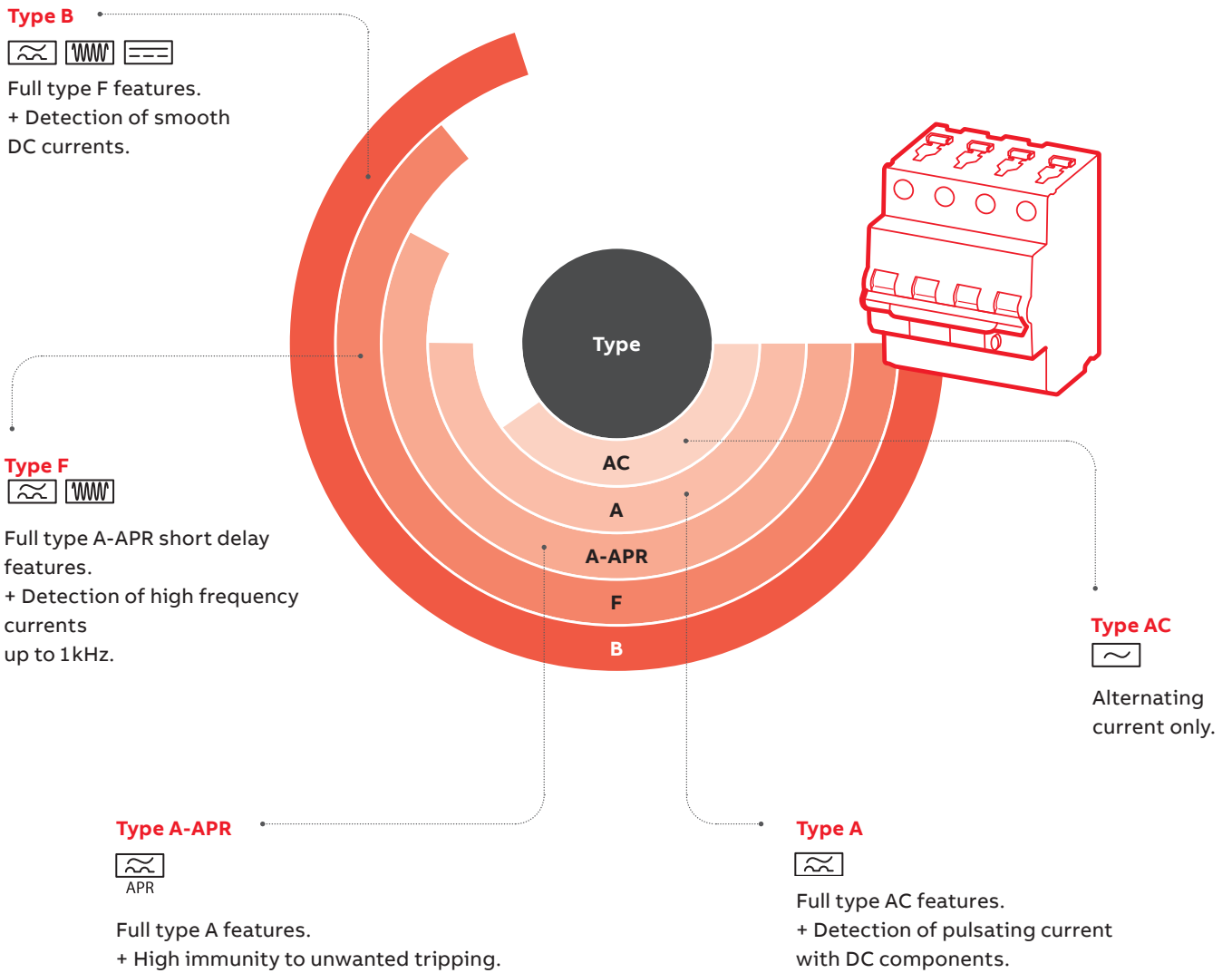



The variety of residual current devices has continuously increased in last decades following the technology evolution and the massive introduction of electronics in all fields of applications. According to the capability to detect different waveforms of residual current and the relative

sophisticated type testing, today the spectrum of RCDs types covers from pure AC loads up to high frequency and DC related applications with an increasing level of protection passing from AC types up to F and B types.



## RCDs technical details

### Properties

Release current		RCD type			
		Type AC	Type A	Type F	Type B
	0,5 ... 1 I <sub>Δn</sub>	■	■	■	■
	0,35 ... 1,4 I <sub>Δn</sub>	-	■	■	■
	0,25 ... 1,4 I <sub>Δn</sub> 0,11 ... 1,4 I <sub>Δn</sub>	-	■	■	■
	max. 1,4 I <sub>Δn</sub> + 6mA	-	■	■	■
	max. 1,4 I <sub>Δn</sub> + 10mA	-	-	■	■
	0,5 ... 1,4 I <sub>Δn</sub>	-	-	■	■
	0,5 ... 2 I <sub>Δn</sub>	-	-	-	■
	0,5 ... 2,4 I <sub>Δn</sub> 0,5 ... 6 I <sub>Δn</sub> 0,5 ... 14 I <sub>Δn</sub>	-	-	-	■

## RCDs technical details

### Properties

#### Partial selectivity

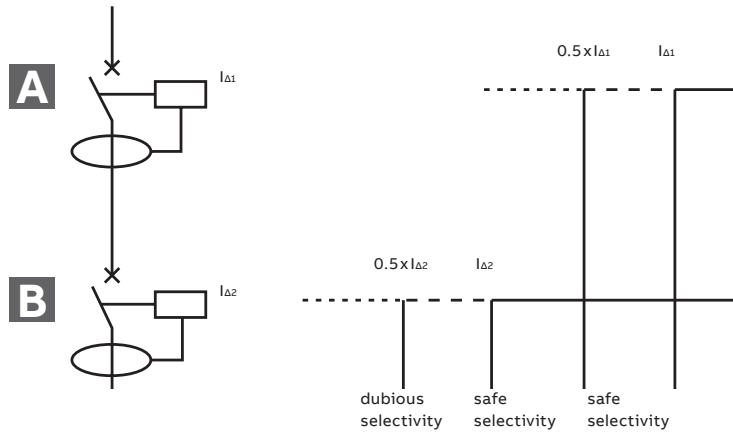

#### Total selectivity

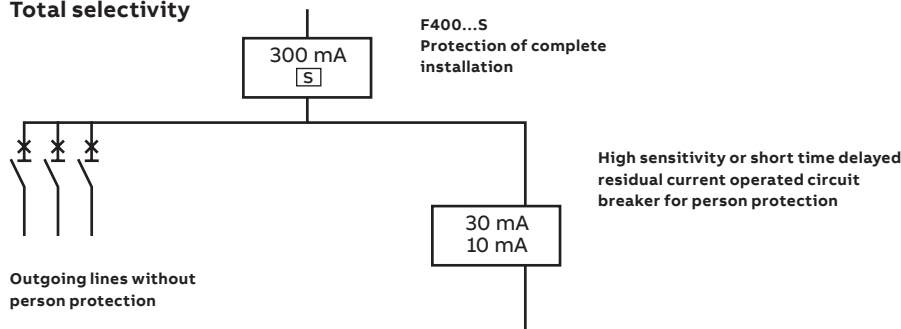

#### Amperometric (partial) selectivity

Selectivity may be created by placing low-sensitivity RCDs upstream and higher-sensitivity RCDs downstream.

An essential condition which must be satisfied in order to achieve selective co-ordination is that the  $I_{\Delta 1}$  value of the breaker upstream (main breaker) is more than double the  $I_{\Delta 2}$  value of the breaker downstream. The operative rule to obtain an amperometric (partial) selectivity is  $I_{\Delta n}$  of the upstream breaker =  $3 \times I_{\Delta n}$  of the downstream breaker (e.g.: F404, 300 mA upstream; F402, 100 mA downstream).

In this case, selectivity is partial and only the downstream breaker trips for earth fault currents  $I_{\Delta 2} < I_{\Delta m} < 0,5 \times I_{\Delta 1}$ .

#### Chronometric (total) selectivity

To achieve total selectivity, delayed or selective RCDs must be installed.

The tripping times of the two devices connected in series must be co-ordinated so that the total interruption time  $t_2$  of the downstream breaker is less than the upstream breaker's no-response limit time  $t_1$ , for any current value. In this way, the downstream breaker completes its opening before the upstream one.

To completely guarantee total selectivity, the  $I_{\Delta}$  value of the upstream device must also be more than double that of the downstream device in accordance with IEC 64-8/563.3, comments. The operative rule to obtain an amperometric (partial) selectivity is  $I_{\Delta n}$  of the upstream breaker =  $3 \times I_{\Delta n}$  of the downstream breaker (e.g.: F404, S type, 300 mA upstream).

For safety reasons, the delayed tripping times of the upstream breaker must always be below the safety curve.

## RCDs technical details

### Standard, short-time delayed and selective type

The use of multiple electronic reactors for the supply of fluorescent lamps instead generates permanent leakage currents and inrush currents that can provoke nuisance tripping of a standard residual current breaker.

IT system loads and other electronic equipment (e.g. dimmers, computers, inverters) with capacitive input filters connected between the phases and ground can also generate permanent earth leakage currents whose sum may provoke the nuisance tripping of a standard residual current breaker.

For these situations, the SHORT-TIME DELAY breakers allow a greater number of devices to be connected to the installation.

Soft-starters for motors are loads which can generate high-frequency capacitive currents (provoked by the harmonics) toward ground or fed into the network. Also in this case, the use of SHORT-TIME DELAY residual breakers reduces the sensibility to nuisance tripping.

Compared with standard type breakers, SHORT-TIME DELAY residual current breakers are therefore characterised, for any given sensibility, by:

- Higher residual trip current
- Tripping time delay
- Better resistance to overvoltages, harmonics and impulse disturbances.

#### Regulations

The tests set out in the IEC 61008 and IEC 61009 standards verify the resistance of residual current breakers to unwanted tripping provoked by operation overvoltages, using a ring wave impulse shape of  $0.5\mu\text{s}/100\text{kHz}$ . All residual current circuit-breakers are required to pass this test with a peak current value of 200A.

For what concerns atmospheric overvoltages, the IEC 61008 and 61009 standards prescribe the 8/20  $\mu\text{s}$  surge test with a 3000A peak current, but limit the requirement to residual current devices classified as selective; no test is required for other types.

The ABB range of SHORT-TIME DELAY anti- nuisance tripping breakers and blocks pass the general  $0.5\mu\text{s}/100\text{kHz}$  ring wave test and also withstand the 8/20  $\mu\text{s}$  impulse test with the same peak current of 3000A prescribed for selective devices.

The F402 K and F404 K should therefore be used to prevent unwanted tripping.

#### Three different types of Residual current operated circuit breaker

- standard RCD 30 mA
- selective RCD 300 mA **S**
- short-time delay RCD 30 mA **K** high immunity

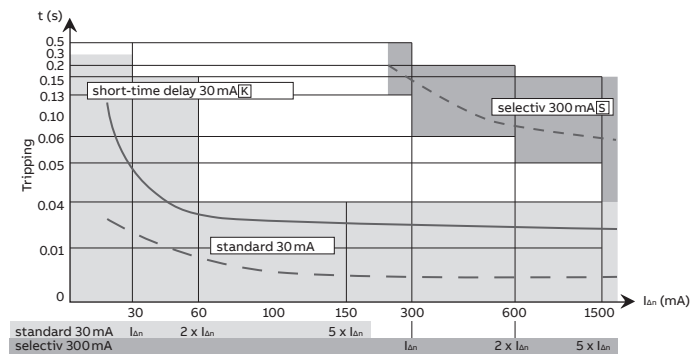

- The display is characteristics view. All exact tripping times please see standards according IEC 61008-1, IEC 61009-1, EN 61008-1 and EN 61009-1.
- The standard RCD 30 mA tripp after circa 22 mA and a release time of  $\leq 35$  ms.
- The selectiv RCD 300 mA tripp after circa 200 mA and a release time of circa 180 ms.
- The short-time delay RCD 30 mA tripp after circa 25 mA and a release time of 100 ... 120 ms.



## RCDs technical details

Standard, short-time delayed and selective type

### Unwanted tripping

In the event of disturbance in the mains, the RCDs normally present in the system are tripped, breaking the circuit even in the absence of a true earth fault.

Disturbances of this kind are most often caused by:

- operation overvoltages caused by inserting or removing loads (opening or closing protection of control devices, starting and stopping motors, switching fluorescent lighting systems on and off, etc.)
- overvoltages of atmospheric origin, caused by direct or indirect discharges on the electrical line.

Under these circumstances, breaker tripping is unwanted, since it does not satisfy the need to avoid the risks due to direct and indirect contacts. On the contrary, the sudden and unjustified interruption of the power supply may result in very serious problems.

### SHORT-TIME DELAY RCDs

The ABB range of SHORT-TIME DELAY anti-disturbance residual current circuitbreakers and blocks was designed to overcome the problem of unwanted tripping due to overvoltages of atmospheric or operation origin.

The electronic circuit in these devices can distinguish between temporary leakage caused by disturbances on the mains and permanent leakage due to actual faults, only breaking the circuit in the latter case.

SHORT-TIME DELAY residual current circuit-breakers and blocks have a slight delay into the tripping time, but this does not compromise the safety limits set by the Standards in force (release time at  $2 I_{\Delta n} = 150$  ms).

Guaranteeing conventional residual current protection, their installation in the electrical circuit therefore allows any unwanted tripping to be avoided in domestic and industrial systems in which service continuity is essential.

This delay makes the SHORT-TIME DELAY residual current devices especially suited for installations involving motor starters/variable speed drives, fluorescent lamps or IT/electronic equipment.

—  
Table of RDC selectivity

Upstream $I_{\Delta n}$		10 [mA] inst	30 inst	100 inst	300 inst	300 S	500 inst
Downstream $I_{\Delta n}$ [mA]							
10	inst		■	■	■	■	■
30	inst			■	■	■	■
100	inst				■	■	
300	inst						
300	S						
500	inst						
500	S						

inst = instantaneous S = selective ■ = amperometric (partial) selectivity ■ = chronometric (total) selectivity

## RCDs technical details

### Technical data

#### Coordination tables between Short Circuit Protection Devices (SCPD) and F404 RCCBs

If you are using an RCCB you must verify that the Short Circuit Protection Device (SCPD) protects it from the effects of high current that arise under short-circuit conditions. The IEC/EN 61008 provides some tests to verify the behaviour of RCCB in short-circuit conditions. The tables below provide the maximum withstanding short-circuit current expressed in eff. kA for which the RCCBs are protected thanks to the coordination with the SCPD with a rated current (thermal protection) less than or equal to the rated current of the associated RCCB.

	F404 25 A	F404 40 A	F404 63 A
gG fuse 25 A	100		
gG fuse 40 A	60	60	
gG fuse 63 A	20	20	20
gG fuse 100A	10	10	10
S403M	10	10	10
S803N	20	20	20
S803S	25	25	25

#### Internal resistances and power losses of RCCBs and RCBOs

For RCDs internal resistance and power loss are intended per device (cold resistance at room temperature)

—

**F402**

In [A]	Ri [mΩ]	Pv [W]
25	6.1	3.8
40	5.8	9.3

—

F404			F404B
In [A]	Ri [mΩ]	Pv [W]	Pv [W]
25	6.1	3.8	1.2
40	5.8	9.3	1.2
63	1.1	4.4	1.2

## RCBO Type F technical details

### Properties

Nowadays single phase inverters are present in many household and industrial loads, such as washing machines, hoovers, dishwashers, ventilation, pumps etc.... Inverter technology is a “plus” in domestic equipment, since it helps to reach better performance reducing power consumption and improving energy efficiency.

#### Working principle

A single phase frequency converter, also named inverter, is a commonly used electric drive which regulates the speed of an electric motor, operating on supply voltage and frequency.

During normal operation, the current generated by a single phase inverter in the downstream section is the result of the overlapping of mixed frequency components which varies from 10 Hz (motor frequency), to 50 Hz (rated frequency) and 1000 Hz (switching frequency).

RCDs type F have been specifically designed for single phase inverters applications in order to meet the requirement to assure adequate protection level in case of an earth fault with such harmonic content, offering at the same time an increased resistance to nuisance tripping.

On the other side only RCD type B remain the only devices which are suitable to detect smooth DC components in the residual current caused by insulation faults in the DC section of a three phase frequency converter.

#### Type F features at a glance:

Type F RCDs offer the same range of protection and functionality as an RCD Type A APR; this means that they detect sinusoidal AC currents as well as pulsating DC currents. In addition to this, they are also tested according to IEC/EN 62423 which foresees the application of a simulated multi-frequency residual current with appropriate coefficient associated to the each level of frequency up to 1kHz.

The intervention characteristic has a short-time delayed which prevents unwanted tripping in case pulsed leakage currents of up to ten milliseconds occur at activation of filters.

The RCDs Type F have a surge current withstand capacity of more than 3kA and can accept superimposed smooth DC residual currents of up to 10mA without affecting their standard functionality.

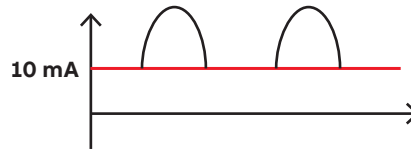

#### Typical residual current waves that can occur in a circuit that supplies a single phase inverter:

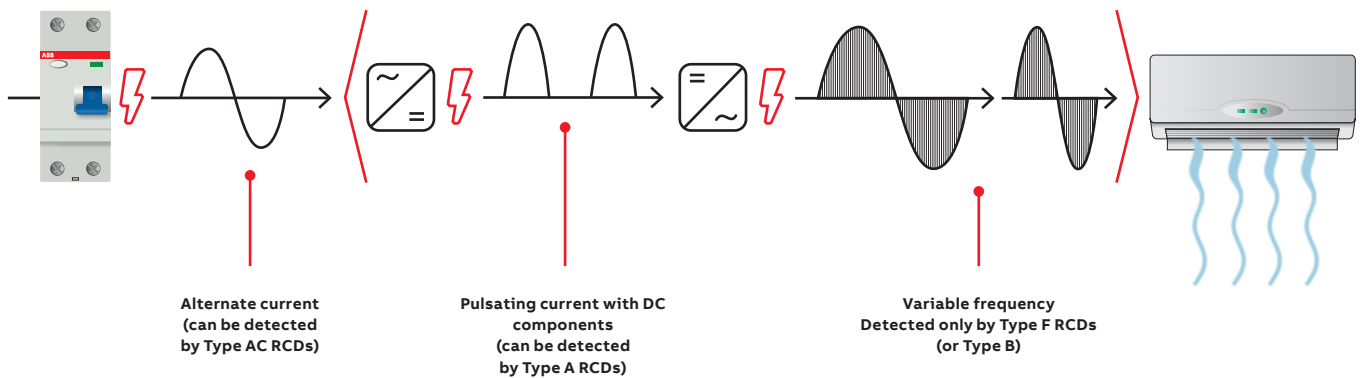

## RCBO technical details

### Internal resistances and power losses, Derating

#### Internal resistances and power losses

For RCBO internal resistance and power loss are intended per device (cold resistance at room temperature)

#### FS401E, FS401M

B, C tripping characteristics

$I_n$ [A]	$R_i$ [mΩ]	$P_v$ [W]
6	53	1.9
10	19	1.9
13	14	2.3
16	11	2.7
20	7.6	3.0
25	7.0	4.4
32	5.5	5.6

#### FS403E, FS403M

B, C tripping characteristics

$I_n$ [A]	$R_i$ [mΩ]	$P_v$ [W]
6	146	5.3
10	49	4.9
13	32	5.4
16	26	6.6
20	19	7.5
25	16	10.1
32	12	12.6

NOTE 1. For RCBO internal resistance and power loss are intended per device

#### FS400E, FS400M, FS400MK

B, C tripping characteristics

$I_n$ [A]	Ambient temperature T (°C)											
	0	10	15	20	25	30*	35	40	45	50	55	60
6	7.10	6.70	6.55	6.40	6.20	6.00	5.80	5.60	5.40	5.20	5.00	4.80
10	11.00	10.70	10.50	10.30	10.15	10.00	9.85	9.70	9.55	9.40	9.25	9.10
13	14.40	14.00	13.75	13.50	13.25	13.00	12.75	12.50	12.25	12.00	11.75	11.50
16	17.40	17.00	16.75	16.50	16.25	16.00	15.75	15.50	15.25	15.00	14.75	14.50
20	21.70	21.10	20.85	20.60	20.30	20.00	19.70	19.40	19.10	18.80	18.50	18.20
25	28.20	27.10	26.60	26.10	25.55	25.00	24.45	23.90	23.35	22.80	22.25	21.70
32	36.00	34.70	34.00	33.30	32.65	32.00	31.35	30.70	30.05	29.40	28.75	28.10

\*Reference ambient air temperature for overload tripping

#### Influence of adjacent poles Correction factor $F_m$

No. of adjacent poles	correction factor
1...3 poles	1
5...6 poles	0.86
6	0.8
7	0.78
8	0.77
9	0.76
10	0.76



## RCBO technical details

Limitation of specific let-through energy  $I^2t$ , peak current  $I_p$

### $I^2t$ diagrams - Specific let-through energy value $I^2t$

The  $I^2t$  curves give the values of the specific let-through energy expressed in  $kA^2s$  (A=amps; s=seconds) in relation to the perspective short-circuit current ( $I_{rms}$ ) in kA.

#### FS400M characteristics B-C

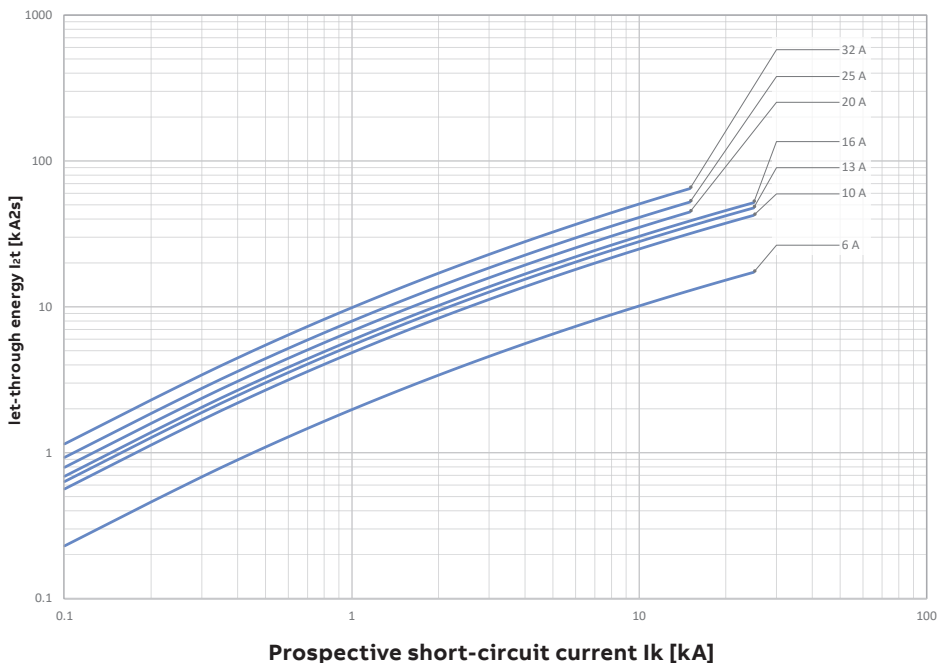

### Limitation curves – Peak current values

The  $I_p$  curves give the values of the peak current, expressed in kA, in relation to the perspective symmetrical short-circuit current (kA).

#### FS400M Characteristics B-C

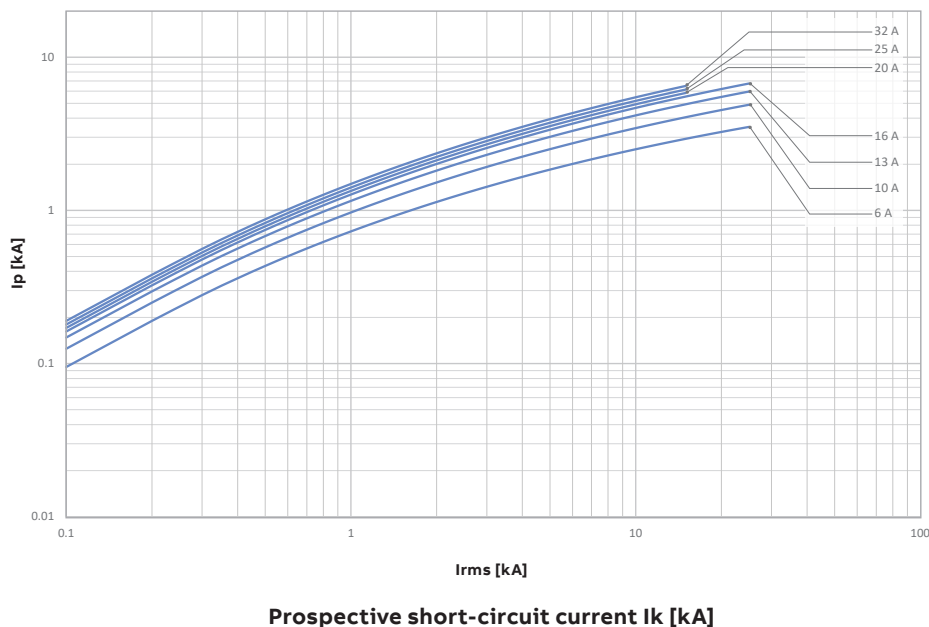

## OVR technical details

### Surge arrester OVR



The type 2 surge arresters in the QuickSafe product range are suitable for protecting electrical low voltage systems and terminals in the 240/415V system. The devices can be used as type 2 surge arresters within the scope of the lightning protection zone concept at zone transition 0B-1 and higher. The high nominal discharge capability of 20 kA makes it possible for the equipment to have a longer service life in comparison to the minimum requirements of the standard. The devices consist of a basic unit and pluggable protection modules, which can be removed extremely easily to carry out insulation measurement. They are fully compatible with SMISSLINE installation devices and the surge arresters in the ABB System pro M model series. The surge arresters are tested as type 2 arresters in accordance with the EN/IEC 61643-11 test standard.

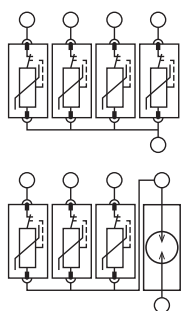

#### Mounting

##### Installation and electrical connection

The over voltage protection device "OVR" will be installed near the front of the protected consumers conditioning.

The surge arrester is to be mounted right after the Incoming block of the socket system.

The OVR404 is snapped directly onto the SMISSLINE bus bar system.

## Surge and lightning protection solutions

Products Standards, IEC 61643

The New IEC 61643-11:2011 is similar to the EN 61643-11:2012 and are the standards for Low-Voltage Surge Protective Devices. These standards exist since the nineties and have gone through different releases improving them. In the last release not only the evaluation of the product performances is under focus, but the stress on safety evaluation.

Regarding performances, this new edition recognizes the possibility to evaluate and certify a SPD under multiple categories, option not considered in the previous editions. So in order to certify an SPD under the Type 1 and Type 2 category, two different tests need to be performed to validate the features under each one of them.

Until now, the safety of the SPD was verified reproducing situations that represent the working conditions of the SPD, as for example, the short-circuit test or the temporary over-voltage test. According to the new edition of the standard, new tests reproducing the potential interruption of the Neutral conductor and the different modes of end of life of the SPD are performed.

These two additional tests are a real Plus on safety management and they are a guarantee for the final user that the installation will not suffer any stress in case of the end of life of the SPD. The new QuickSafe® range has been specially developed to answer to these new requirements. All this reducing the stress on the back-up protection device.

The new QuickSafe® technology allows to comply with the end of life tests thanks to a patented internal disconnection system, this systems disconnects the internal circuit before the internal components (MOVs) go into short-circuit.

The advantage for the customer is that the product is self-protected up to higher values of current and this allows to install back-up protection elements with higher rated current, as these elements will only intervene in the rear case of a short-circuit on site together with a sudden End of Life of the SPD (this happens when for example the SPD is hit by a current higher than its I<sub>max</sub>).

You will find the tables on page 36 indicating the maximum back-up rated current MCB or fuse to use to guarantee the coordination.

This new technology allows as well to increase the prospective withstand short-circuit current at the point of the installation up to I<sub>sc</sub> = 100kA with a back up protection of maximum rated current of 125A (for OVR T2 QS and OVR T2-T3 QS) and 160A (for OVR T1-T2s QS and OVR T2s QS).

### What's new in IEC/EN 61643-11:2012?

- New test procedure which takes into account the failure behavior of protective equipment in the event of an overload, or when the service life has expired
- The Type 1 operating duty test is conducted with a higher current than that specified in the previous standard
- Recognition of the mixed types, as Type 1+2 and Type 2+3, this allows as to certify the product with more than one category.

In simple words, the new OVR QuickSafe® can be used in 99.9% of standard installations and becomes an easy replacement to any other SPD ranges.

### Thermal Disconnection – Temperatures measured at the disconnection point of the MOV

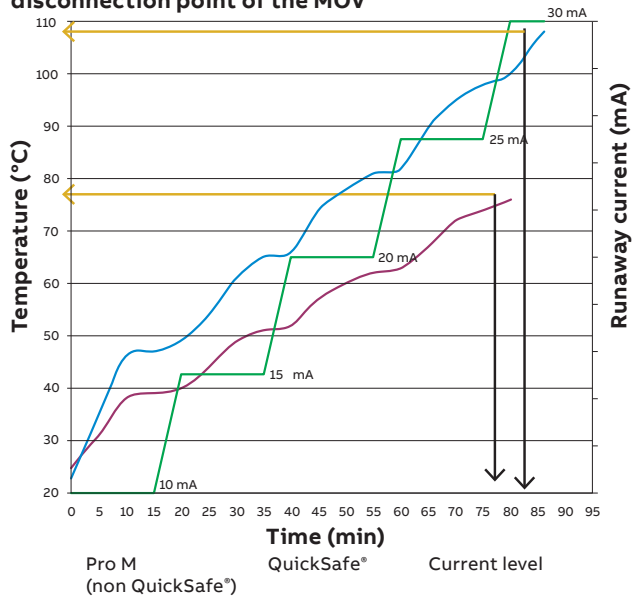

Here we can see 2 different curves representing the behavior of the actual range (blue curve) and the new QuickSafe® range (red curve), for the same level of current (the green line represent the evolution of the current with the time, as specified by the IEC 61643-11).

- These curves represent the temperature INCREASE that the MOV suffers when being tested under these values of current for the indicated time. These are NOT absolute temperature, but relatives ones
- As you can see with the black arrows, the time to guarantee the disconnection fo the same level of current has been reduced by 6 minutes
- And even better, as you can see with the orange arrows, the maximum reached temperature required to guarantee the disconnection is lower, from 108 to 76 °C.

# OVR technical details

## Coordination

### Coordination of surge protection devices

The first over voltage protection device does not provide effective protection for the entire power system. Therefore, a coordination of the over voltage protection devices with each other is required.

**Configuration 1**  
 $15 \text{ kA} \leq I_p \leq 50 \text{ kA}$

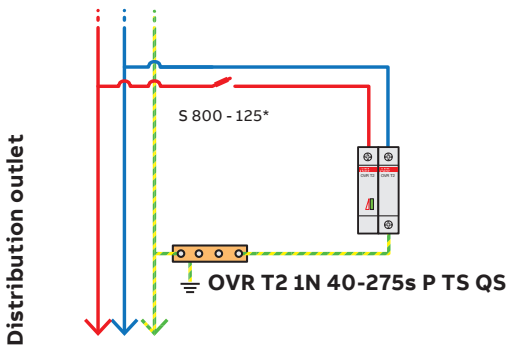
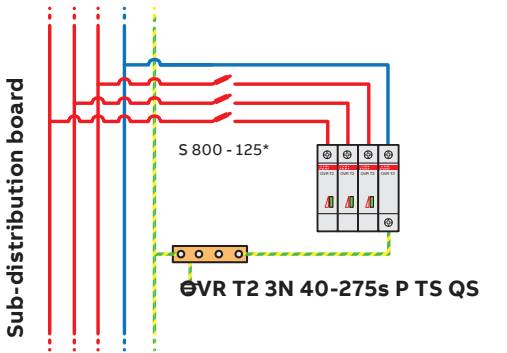
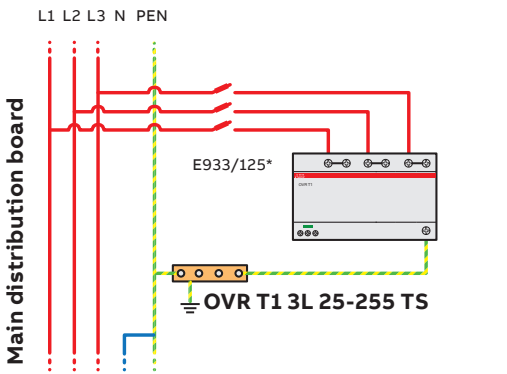

**Configuration 2**  
 $7 \text{ kA} \leq I_p \leq 15 \text{ kA}$

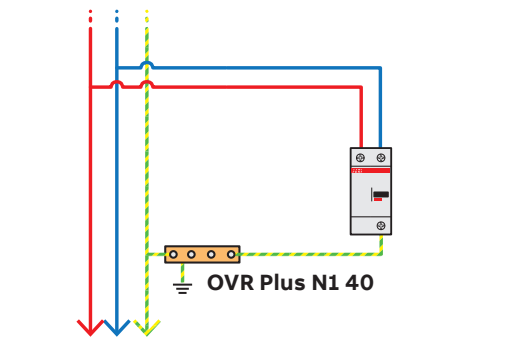
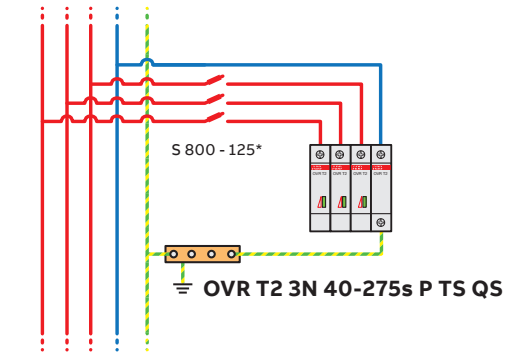
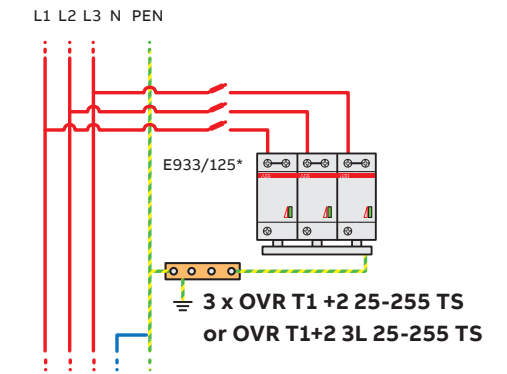



## Surge and lightning protection solutions

### Selection of surge protective devices

#### End of life indicator of the standard surge protective device

This option enables indication of the surge protective device state via a mechanical indicator which changes from green to red as the surge protective device comes to end-of-life. When this occurs, the surge protective device must be changed as protection is no longer guaranteed.

#### Technical features of the integrated auxiliary contact

- Contacts information: Normally-opened (NO)/Normally-closed (NC)
- Min. load: 12VDC – 10 mA
- Max. load: 250VAC – 1A
- Connection cross-section: 1.5mm<sup>2</sup>.

#### Pluggable

The pluggable feature of ABB surge protective devices facilitates maintenance. Should one or more worn cartridges need to be replaced, the electrical circuit does not have to be isolated nor do the wires have to be removed.

#### Auxiliary contact (TS)

This function, achieved by wiring a 3-point 1A volt-free contact, enables the operational state of the surge protective device to be checked remotely (maintenance premises). For standard products, the TS changes status when the cartridge needs to be replaced, protection is not guaranteed. On products fitting the Safety Reserve (s) system, it indicates that one component of the cartridge is damaged, but the protection is still guaranteed.

#### End-of-life indicator standard SPD

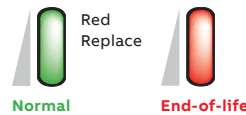

#### NOTE:

A faulty surge protective device does not interrupt continuity of service (if wired such that priority is given to continuity of service), it simply disconnects itself. But, the equipment is no longer protected.



#### NOTE:

Pluggable surge protective device cartridges have a foolproof system (Neutral cartridges different to Phase cartridges) preventing incorrect operations when replacing a cartridge.

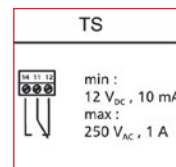

Wiring schematic

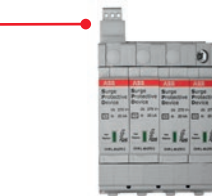

Surge protective device fitted with the auxiliary contact option

## Auxiliary switches and signal contacts

### Wiring variants

#### 1. Wiring without auxiliary busbars LA, LB

Wiring of auxiliary switch and signal contact blocks without contact to the auxiliary busbars LA and LB.

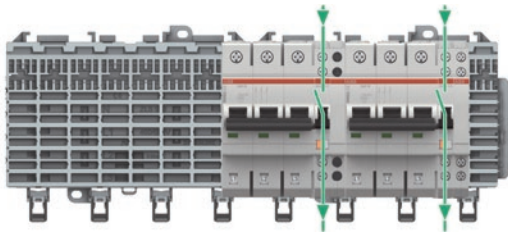

#### 2. Input contacts the auxiliary busbars LA, LB. Standard output wiring.

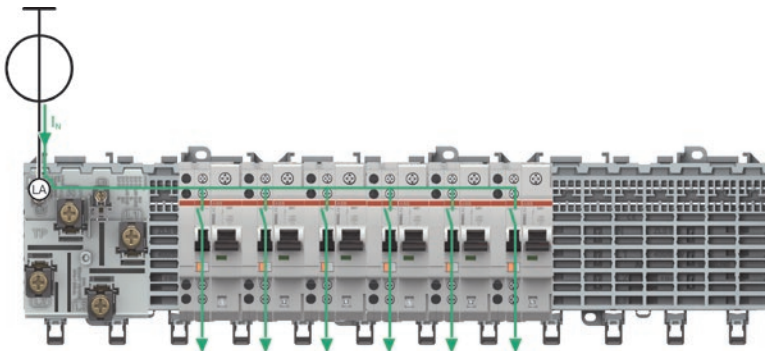

#### 3. Collective alarm, signal contact contacts the auxiliary busbars LA, LB

A cost-effective collective alarm solution can be implemented without additional wiring by using this arrangement.

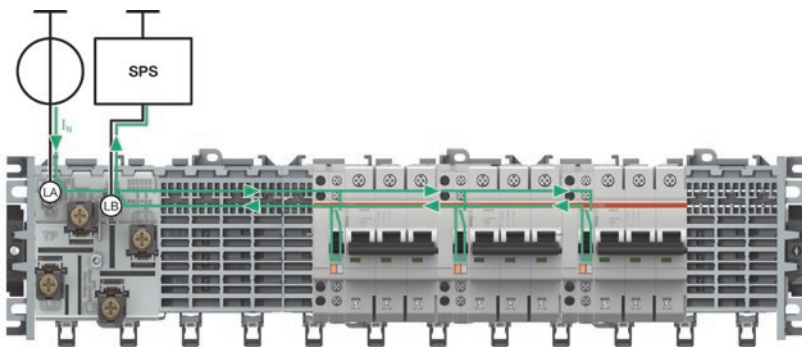

#### Contact description signal contact

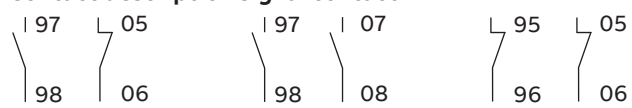

#### Contact description auxiliary contact

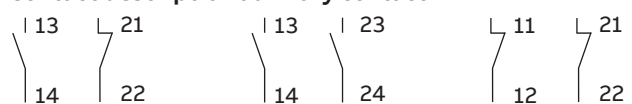

## Auxiliary switches and signal contacts

### Contact arrangements to auxiliary busbars



#### Left/right mounting of auxiliary switch/signal contact for miniature circuit breaker

##### Space-saving on the socket system

By mounting the auxiliary switches/signal contacts alternately on the left and right, the installation width on the SMISSLINE socket system can be reduced. A dummy housing is therefore not needed when just using auxiliary switches or signal contacts.

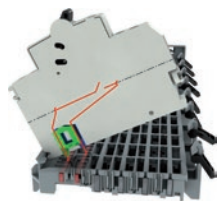

S400 miniature circuit breakers with auxiliary switches mounted on left and right: 25% space saving

S400 miniature circuit breakers with NT40163 9 mm on the right and S400 with auxiliary switch on the left: 20% space saving



#### Supply options for auxiliary busbars LA and LB

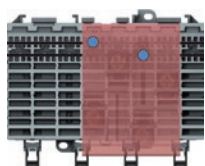

Supply option for auxiliary busbars using incoming terminal block.

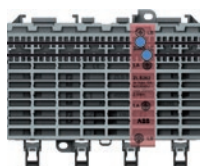

Supply option for auxiliary busbars using incoming terminal block.

#### Positioning of contacting piece ZLS632 on auxiliary switch and signal contact

The small auxiliary switch/signal contact contacting piece can be simply and quickly changed from the position of the LA to the LB auxiliary busbar by reversing it by 180 degree.

#### HK/SK 1NO, 1NC

#### Signal or auxiliary contact Collective alarm

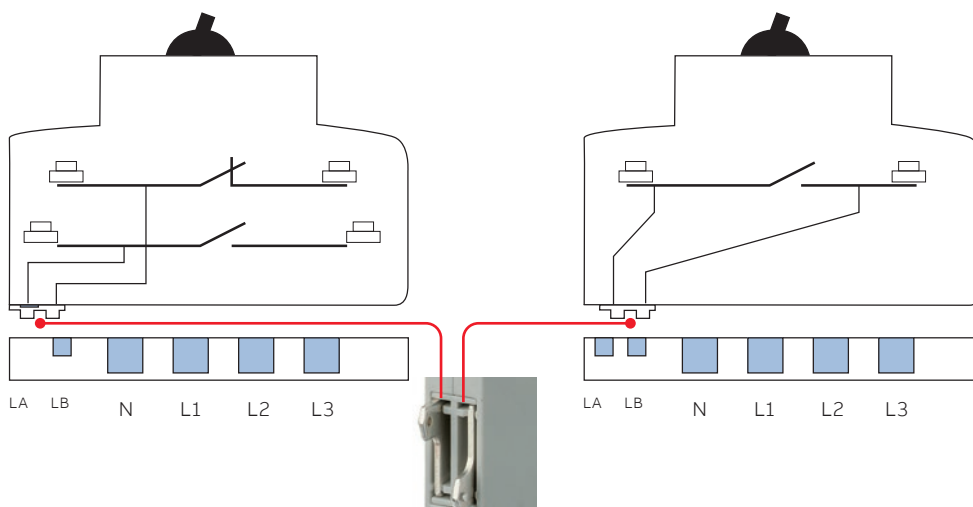

# Shunt trip for S400

## Technical details



### Shunt trips

Function: remote opening of the device when a voltage is applied suitable for MCB S400.

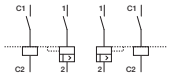

### Shunt trip

			S2C-A1						S2C-A2				
Rated voltage	AC	V	12 ... 60						110 ... 415				
	DC	V	12 ... 60						110 ... 250				
Max. release duration		ms	< 10						< 10				
Min. release voltage	AC	V	7						55				
	DC	V	10						80				
Consumption on release	Ub	V	12 DC	12 AC	24 DC	24 AC	60 DC	60 AC	110 DC	110 AC	220 DC	230 AC	415 AC
	Ib max	A	2.2	2.5	4.5	5	14	8.8	0.35	0.5	1.1	1.0	2.7
Coil resistance		Ω	3.7						225				
Terminals		mm <sup>2</sup>	16						16				
Tightening torque		Nm	2						2				
Dimensions (HxDxW)		mm	100x69x17.5						100x69x17.5				





# Table of contents

<b>01. Dimension of SMISLINE</b>	150
----------------------------------	-----

# SMISLINE dimensions (in mm)

—  
01 8-module socket  
ZLS908 and additional  
socket ZLS928  
including end piece

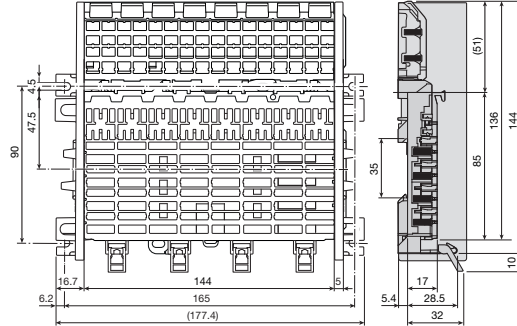

01

—  
02 8-module socket  
ZLS908 and additional  
socket ZLS928

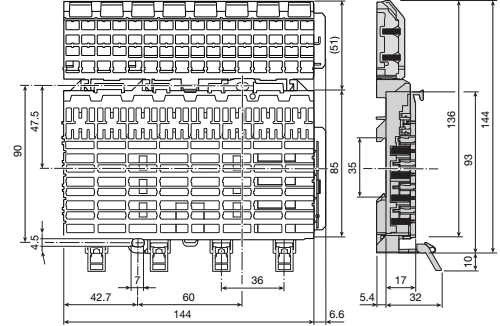

02

—  
03 8-module  
socket ZLS908

—  
04 6-module  
socket ZLS906

—  
05 6-module socket  
ZLS906 and additional  
socket ZLS926  
including end piece

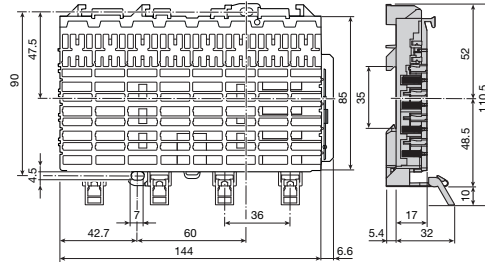

03

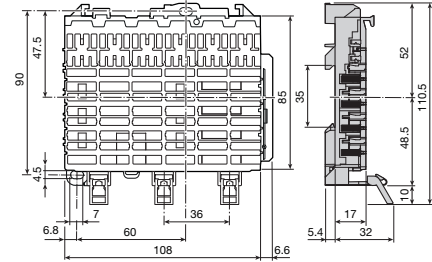

04

—  
06 6-module socket  
ZLS906 and additional  
socket ZLS926

—  
07 8-module socket  
ZLSP908 and additional  
socket ZLSP928  
including end piece

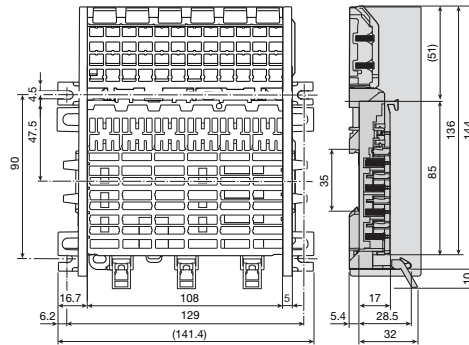

05

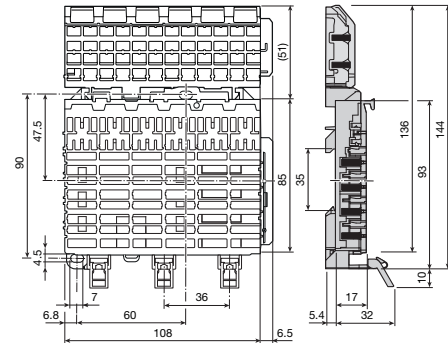

06

—  
08 8-module socket  
ZLSP908 and additional  
socket ZLSP928

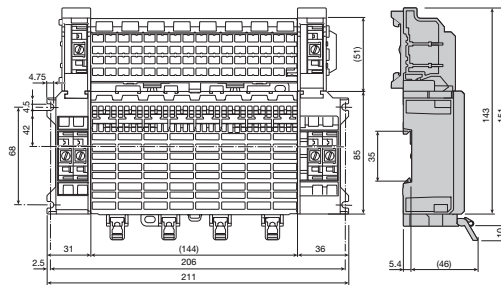

07

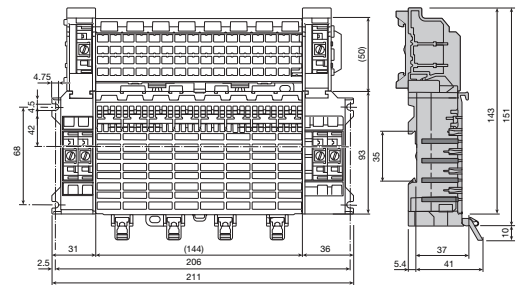

08

## SMISSLINE dimensions (in mm)

- 01 6-module socket ZLSP906
- 02 6-module socket ZLSP906 and additional socket ZLSP926 including end piece
- 03 6-module socket ZLSP906 and additional socket ZLSP926
- 04 6-module socket ZLSP906
- 05 Terminal for additional socket
- 06 Incoming terminal block 63A ZLS260-261
- 07 Incoming terminal block 160A ZLS924

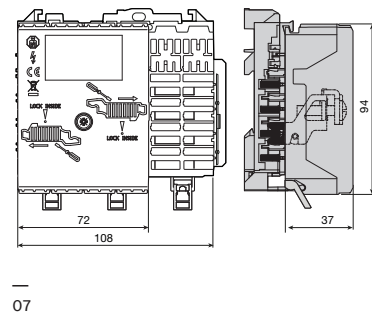
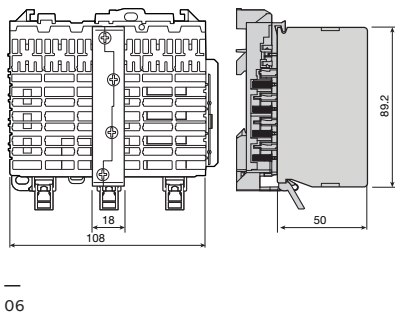
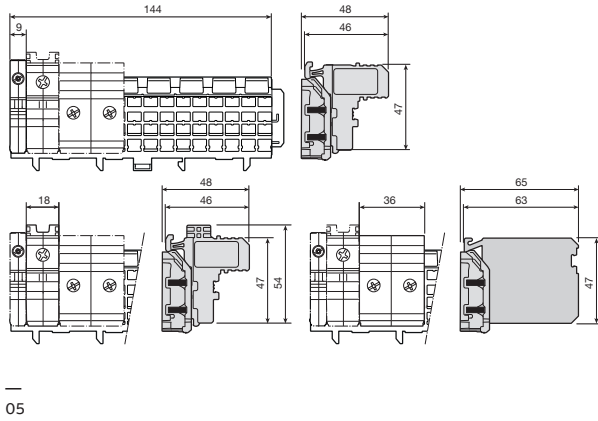
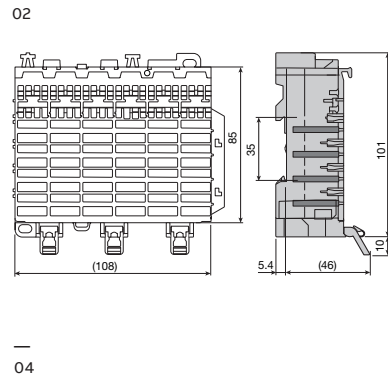
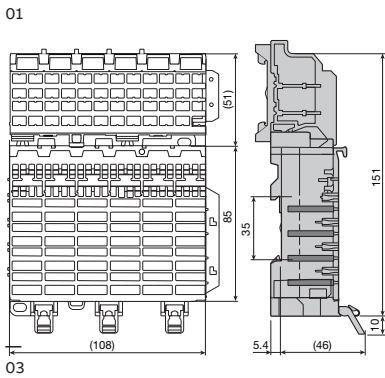
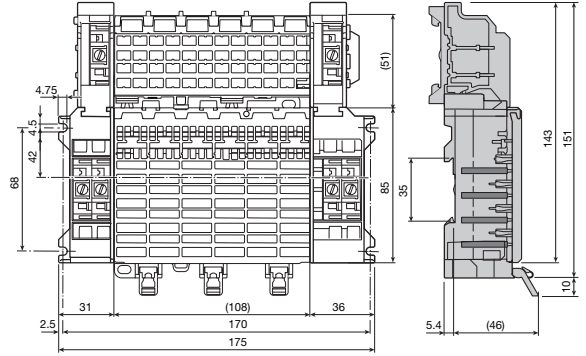
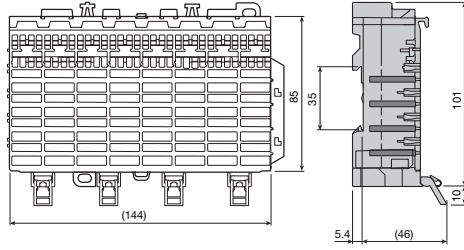



# SMISSLINE dimensions (in mm)

- 01 Incoming components 200A
- 02 DIN rail adapters
- 03 DIN rail adapters for S800
- 04 DIN rail adapters for S800
- 05 Combi module and adapter for manual motor starter MS116 and MS132
- 06 Covering of main and auxiliary busbars ZLS100
- 07 Covering of main and auxiliary busbars ZLS100 with DIN adapter ZLS101
- 08 Intermediate piece ZLS725

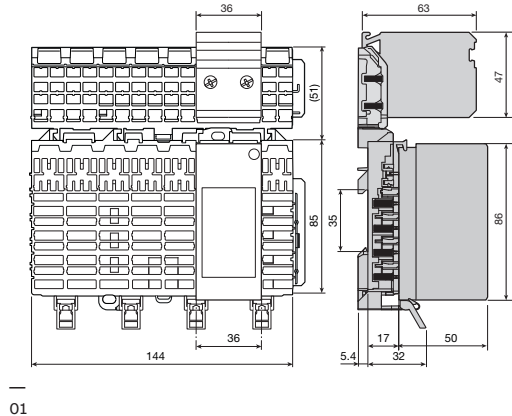

01

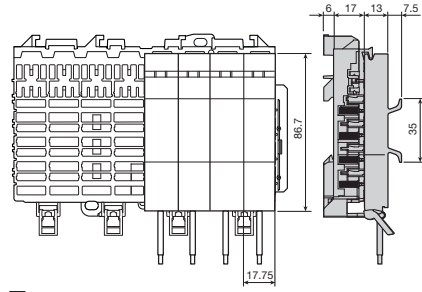

02

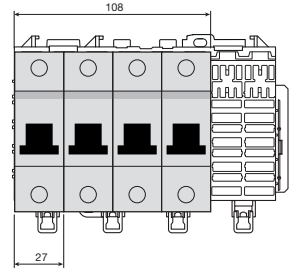

03

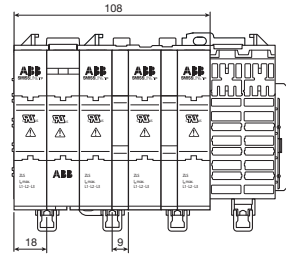

04

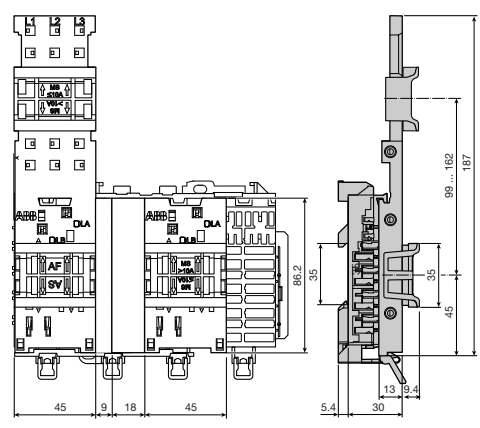

05

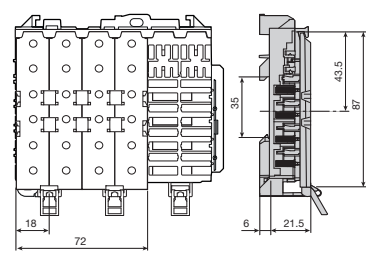

06

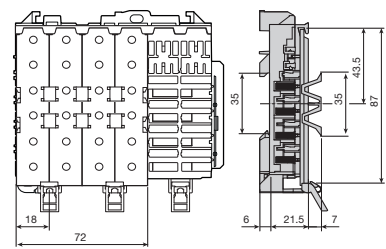

07

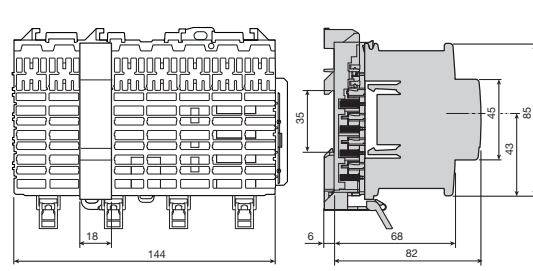

08

## SMISLINE dimensions (in mm)

- 01 Incoming block 250A ZLSP25X
- 02 Incoming terminal block 250A ZLSP934 left version
- 03 Incoming terminal block 250A ZLSP934 right version
- 04 Busbar system 250 A Direct feed ZLSP960 left version
- 05 Busbar system 250 A Direct feed ZLSP960 right version

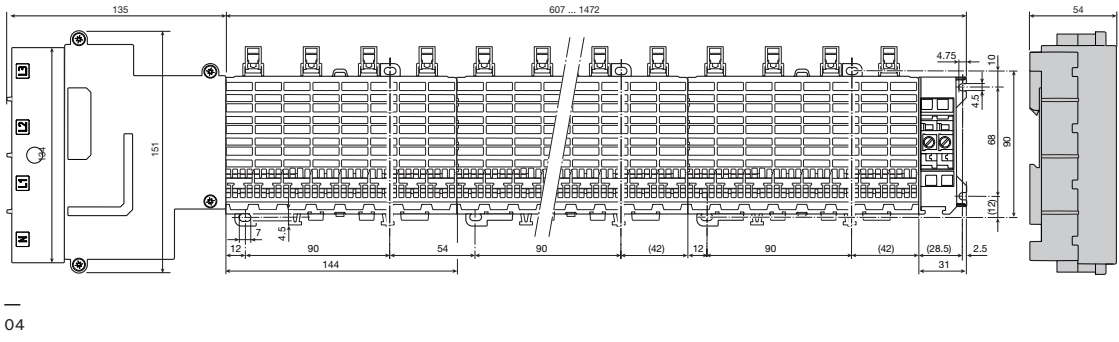
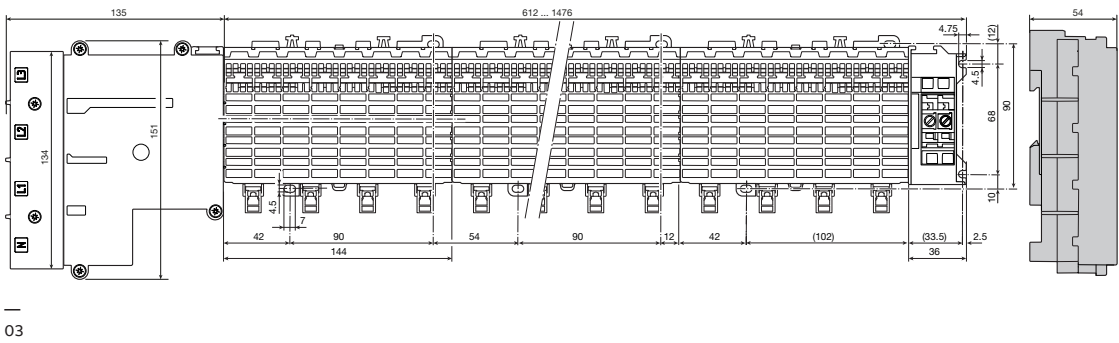
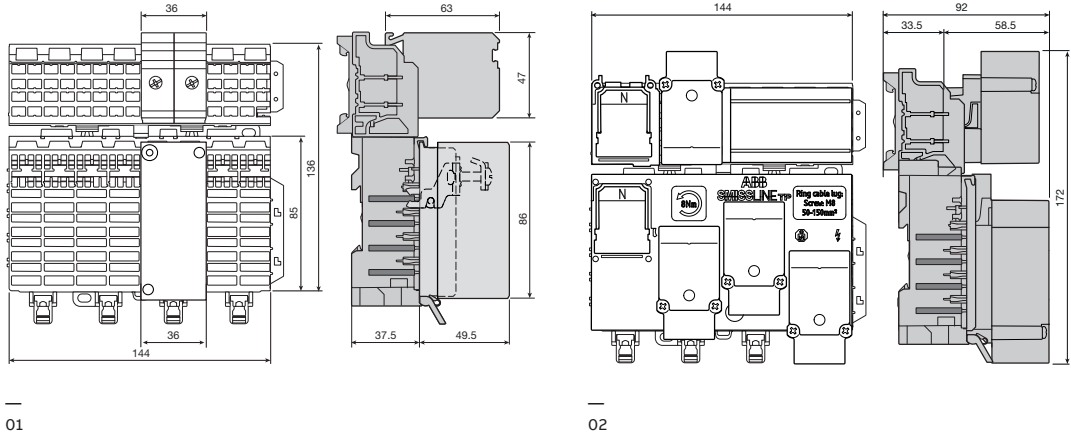

## SMISLINE dimensions (in mm)

- 01 Direct feed heat sink
- 02 Miniature circuit breaker S400
- 03 Miniature circuit breaker SUP401
- 04 Miniature circuit breaker SUP402
- 05 Miniature circuit breaker SUP403
- 06 Residual current operated circuit breaker F402
- 07 Residual current operated circuit breaker F404 type A

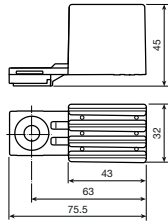

01

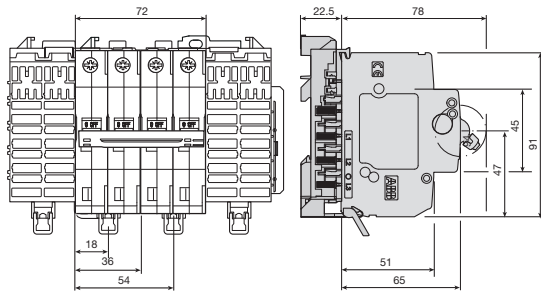

02

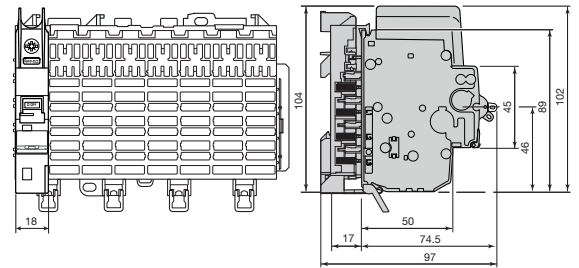

03

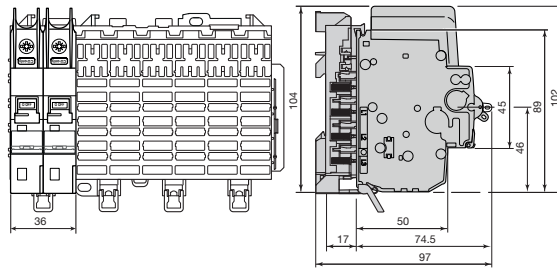

04

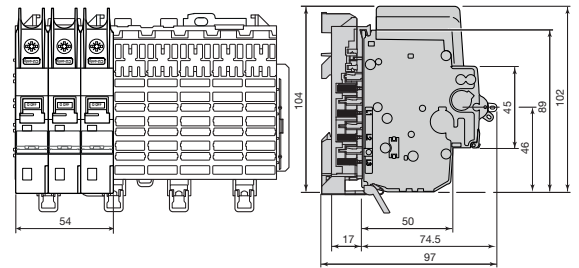

05

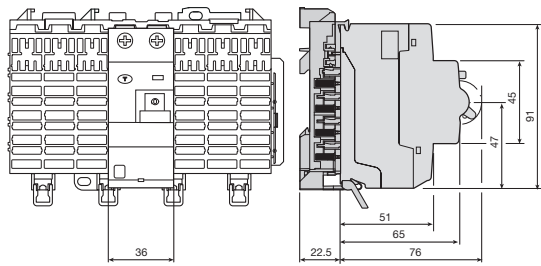

06

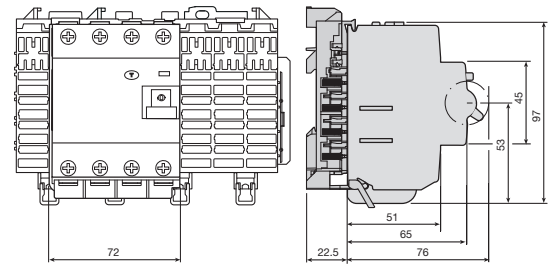

07

## SMISLINE dimensions (in mm)

—  
01 Residual current operated circuit breaker (RCBO) FS401

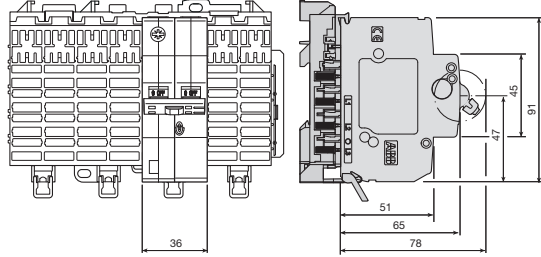

01

—  
02 Residual current operated circuit breaker (RCBO) FS403

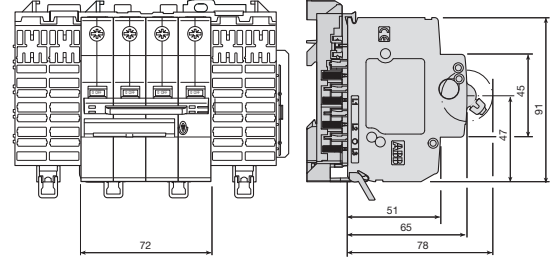

02

—  
03 Residual current operated circuit breaker (RCBO) FS402

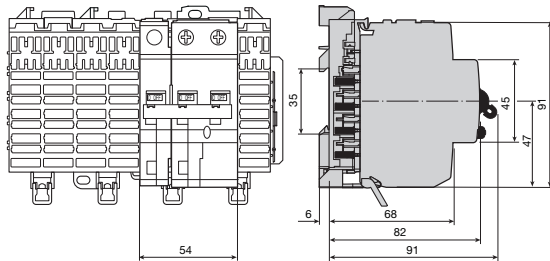

03

—  
04 Surge arrester (SPD) OVR404

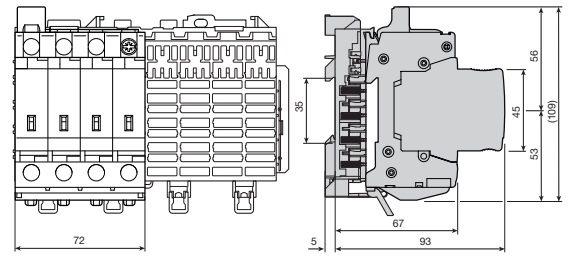

04

—  
05 Auxiliary switch and signal contacts

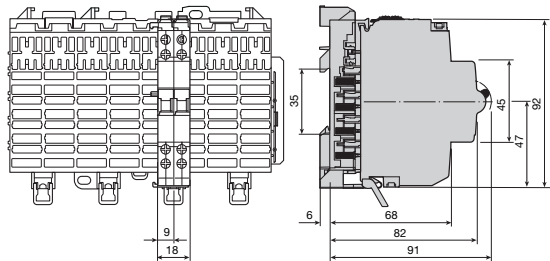

05

—  
06 Neutral disconnector NT400

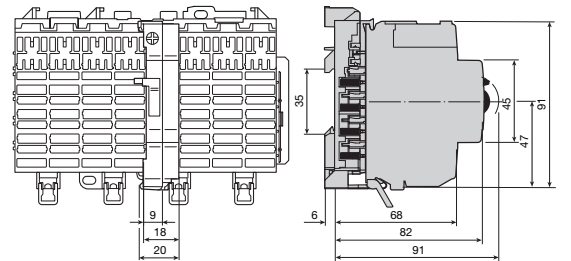

06

—  
07 Residual current operated circuit breaker F404 type B

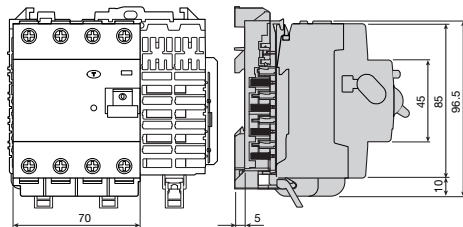

07

















# Table of contents

<b>01. Approvals and standards</b>	158
------------------------------------	-----

# Approvals and standards

	CH	CH	DE	US CA		CN	AU											
																		
S400E Miniature circuit breaker B and C	●		●															
S400M Miniature circuit breaker B and D	●		●															
S400M Miniature circuit breaker C	●		●		●	●	●	●	●	●	●	●	●	●	●	●	●	●
S400M Miniature circuit breaker K	●		●		●	●	●	●	●	●	●	●	●	●	●	●	●	●
S400M Miniature circuit breaker UC C, Z						●	●	●	●	●	●	●	●	●	●	●	●	●
S400P Miniature circuit breaker			●			●	●	●	●	●	●	●	●	●	●	●	●	●
SUP400 Miniature circuit breaker (CCC only 2 A...30A)				●			●	●	●	●	●	●	●	●	●	●	●	●
F402 Residual current operated circuit breaker		●	●															
F404 Residual current operated circuit breaker			●															
F404 Residual current operated circuit breaker type B																		
FS401E/FS401M Residual current operated circuit breaker B and C	●		●				●	●										
FS403E/FS403M Residual current operated circuit breaker B and C	●		●		●		●											
FS401/403 Residual current operated circuit breaker Type F	●		●		●		●											
IS404 switch disconnector																		
OVR404 Surge arrester																		
HK400/SK400 Auxiliary switch and signal contacts	●				●	●	●	●	●	●	●	●	●	●	●	●	●	●
Busbar system incl. incoming 125A			●	●	●	●	●	●	●	●	●	●	●	●	●	●	●	●
Busbar system incl. incoming 250A ZLSP934			●	●	●	●	●	●	●	●	●	●	●	●	●	●	●	●
Direct feed				●	●	●	●	●	●	●	●	●	●	●	●	●	●	●
Busbar system incl. incoming 250A without additional socket				●	●	●	●	●	●	●	●	●	●	●	●	●	●	●
DIN rail adapter acc. UL489 25A and 45A			●	●	●	●	●	●	●	●	●	●	●	●	●	●	●	●
DIN rail adapter IEC and UL508 32A and 63A			●	●	●	●	●	●	●	●	●	●	●	●	●	●	●	●
Adapter for motor starter and contactors				●	●	●	●	●	●	●	●	●	●	●	●	●	●	●

● Approved

