

FLOWERPOWER™

220-240V 50/60Hz 5W/GU10 IP55

EN: MOUNTING  
 NO: MONTERING  
 SE: MONTERING  
 FI: ASENNUS

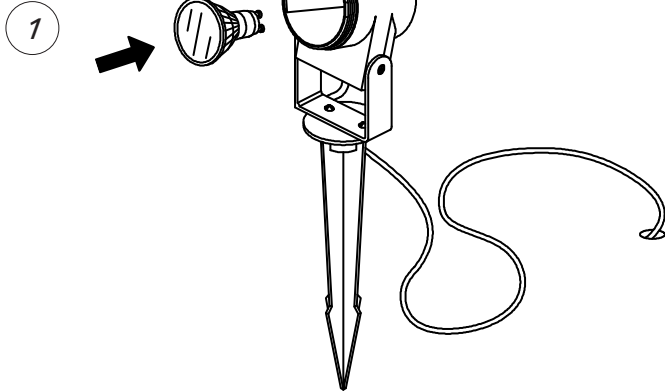

2

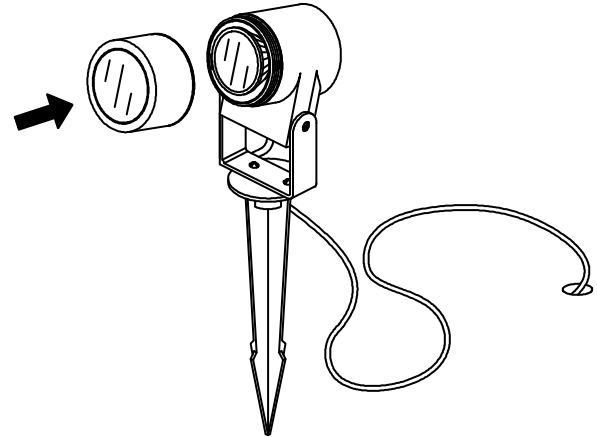

3

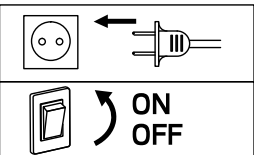
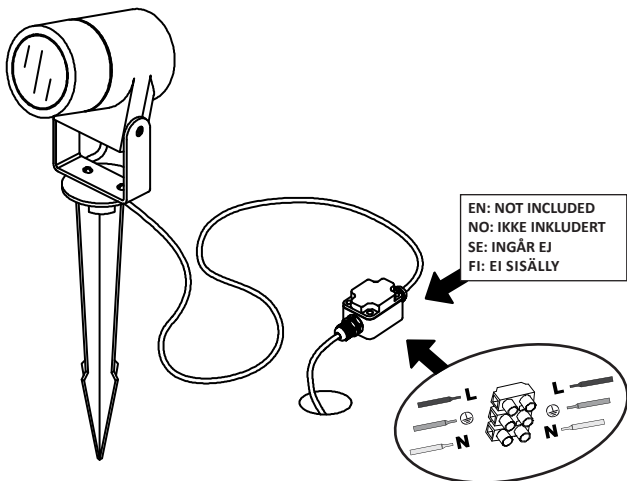

4

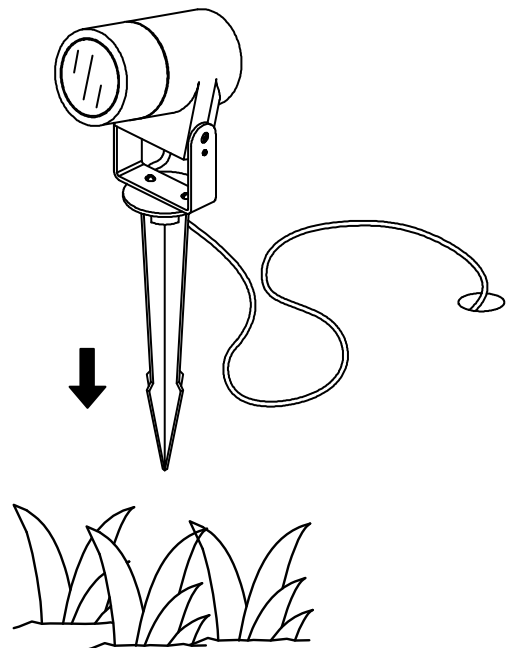

EN: MEASUREMENT  
 NO: MÅL  
 SE: MÅTT  
 FI: MITAT

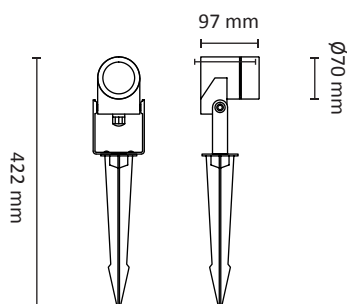

**OBS!**

EN: The luminaire should not be covered by insulation blanket or similar materials in any case.  
 NO: Armaturet skal under ingen omstendigheter dekkes av isolasjonsmatte eller lignende.  
 SE: Under inga omständigheter måste armaturen täcka en isoleringsgardin eller liknande material.  
 FI: Valaisin ei saa missään tapauksessa peittää eristysverho tai vastaavia materiaaleja.

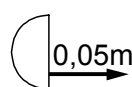

EN: Minimum distance to flammable material in the beam direction.  
 NO: Minimumsavstand til brennbart materiale i armaturens stråleretning.  
 SE: Minsta avstånd mellan brännbart material och lampans ljusrättning.  
 FI: Vähimmäismitta lampusta palaavaan materiaaliin.