

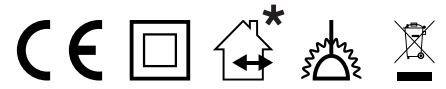

EN: Instruction manual  
 NO: Monteringsveiledning  
 SE: Installationsguide  
 FI: Asennusohje

LUZENSE®



220-240V 50/60Hz LED IP44\*

# SWITCH GYRO®

EN: This product contains a light source of energy efficiency class G  
 NO: Dette produktet inneholder en LED-lyskilde med energieffektivitets-klasse G  
 SE: Denna produkt innehåller en ljuskälla med energieffektivitetsklassen G  
 FI: Tämä tuote sisältää LED -valonlähteen energiatehokkuus luokalla G

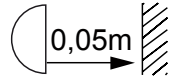

EN: Minimum distance to flammable material in the beam direction.  
 NO: Minimumsavstand til brennbar materiale i armaturens stråleretning.  
 SE: Minsta avstånd mellan brännbart material och lampans ljusrättning.  
 FI: Vähimmäismitta valaisimesta palaavaan materiaaliin.

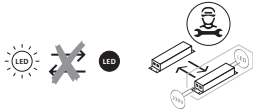

EN: Unreplaceable light source. Replaceable control gear by qualified electrician.  
 NO: Ikke utskiftbar lyskilde. Forkobling kan byttes av autorisert el-installatør.  
 SE: Ej utbyttbar ljuskälla. Drivdon kan bytas av auktoriserad elektriker.  
 FI: Ei vaihdettava valonlähde. Valtuutettu sähköasentaja voi vaihtaa käyttölaitteet.

## OBS!

EN: Installation must be performed by a qualified electrician.  
 NO: Må installeres av autorisert el-installatør.  
 SE: Måste installeras av en behörig elinstallatör.  
 FI: Vain valtuutettu sähköasentaja saa asentaa.

EN: MEASUREMENT  
 NO: MÅL  
 SE: MÅTT  
 FI: MITAT

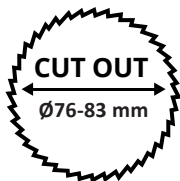
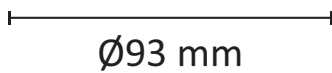
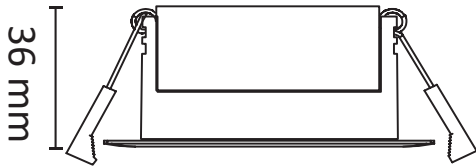

DIP Switch

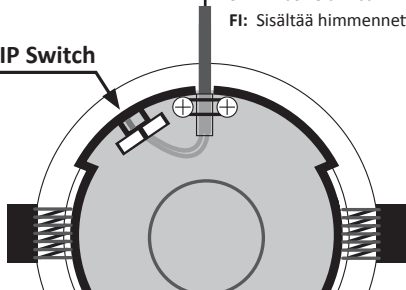

EN: CABLE CONNECTION  
 NO: LEDNINGSTILKOBLING  
 SE: KABELANSLUTNING  
 FI: JOHTOLIITÄNTÄ

Max. 16A  
 Max. 2,5mm<sup>2</sup>

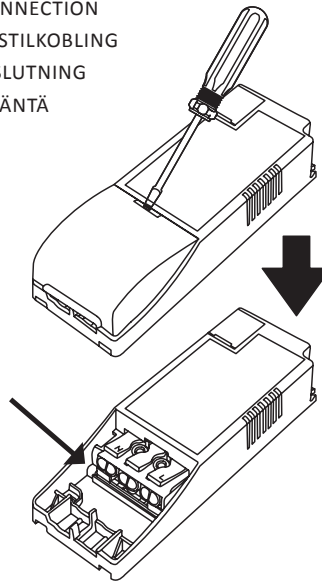

EN: Included dimmable LED driver.  
 NO: Inkludert dimbar LED driver.  
 SE: Inklusive dimbar LED drivdon.  
 FI: Sisältää himmennettävän LED-liitäntälaitteen.

EN: COMPATIBLE PRODUCTS.  
 NO: KOMPATIBLE PRODUKTER.  
 SE: KOMPATIBLA PRODUKTER.  
 FI: YHTEENSOPIVAT TUOTTEET.

	UNIBOX MULTI
	DRIVER PIPE HOUSING



EN: White/black may be used indoors and outdoors.  
 NO: Hvit/sort kan benyttes innendørs og utendørs.  
 SE: Vit/Svart kan användas inomhus och utomhus.  
 FI: Valkoinen/musta sisä- ja ulkokäyttöön.

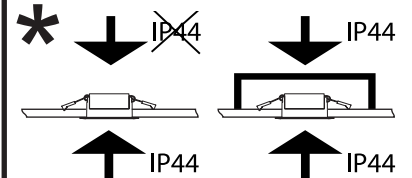

EN: IP44 from the luminaire underside.  
 NO: IP44 fra armaturens underside.  
 SE: IP44 från armaturens undersida.  
 FI: IP44 valaisimen alapuolelta.

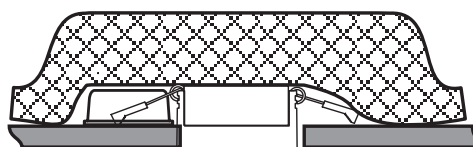
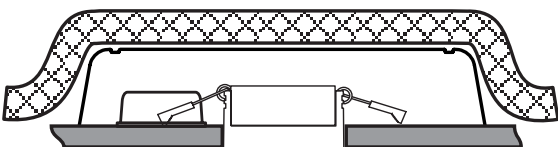
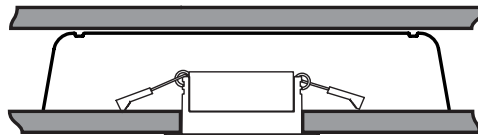
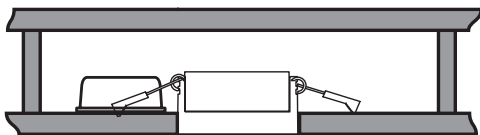

EN: May be covered by insulation sheet.  
 NO: Kan overdekkes av isolasjonsmatter.  
 SE: Kan övertäckas av isolationsmattor.  
 FI: Voi peittää eristysmatolla.