



GYRO® FRAME 1

220-240V 50/60Hz 450mA LED 8W IP44*

EN: MEASUREMENT

NO: MÅL
 SE: MÅTT
 FI: MITAT

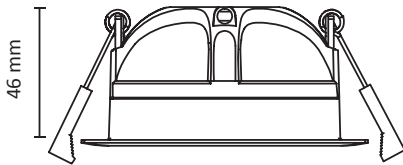

95x95 mm



EN: Installation must be performed by a qualified electrician.
 NO: Må installeres av autorisert el-installatør.
 SE: Måste installeras av en behörig elinstallatör.
 FI: Vain valtuutettu sähköasentaja saa asentaa.

OBS!

EN: CABLE CONNECTION

NO: LEDNINGSTILKOBING
 SE: KABELANSLUTNING
 FI: JOHTOLIITÄNTÄ

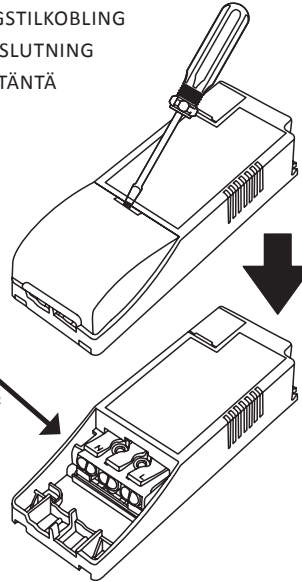

Max. 16A
 Max. 2,5mm²

EN: Included dimmable LED driver.
 NO: Inkludert dimbar LED driver.
 SE: Inklusive dimbar LED drivdon.
 FI: Sisältää himmennettävän LED-liitäntälaitteen.

EN: CORRESPONDING PRODUCT.

NO: TILHØRENDE PRODUKT.
 SE: TILLHÖRANDE PRODUKT.
 FI: AIHEESEEN LIITTYVÄ TUOTE.

UniDim™	KUD-265EV
UniDim™	KUD-500EV-L
UniDim™	KUD-500EV-LS
UniDim™	DUO
UniDim™	MINI
UniDim™	KDT-500IE
WiDim®	WI-FI system
Bluedim®	Bluetooth system
	DOWNLIGHT BOX HIGH
	DOWNLIGHT BOX LOW
	DRIVER PIPE HOUSING

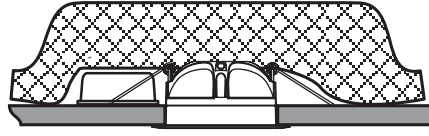
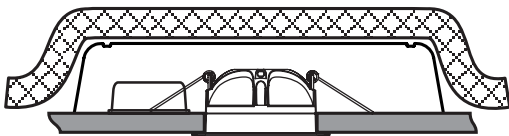
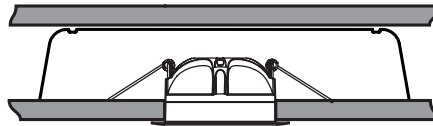
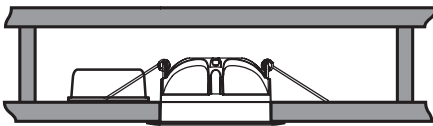

EN: May be covered by insulation sheet.
 NO: Kan overdekkes av isolasjonsmatter.
 SE: Kan övertäckas av isolationsmattor.
 FI: Voi peittää eristysmatolla.



EN: White/black may be used indoors and outdoors.
 NO: Hvit/sort kan benyttes innendørs og utendørs.
 SE: Vit/Svart kan användas inomhus och utomhus.
 FI: Valkoinen/musta sisä- ja ulkokäyttöön.

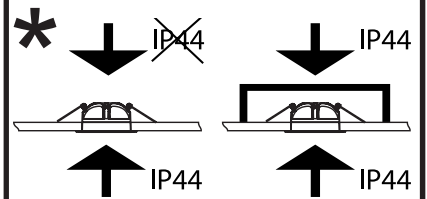

EN: IP44 from the luminaire underside.
 NO: IP44 fra armaturens underside.
 SE: IP44 från armaturens undersida.
 FI: IP44 valaisimen alapuolelta.

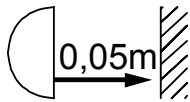

EN: Minimum distance to flammable material in the beam direction.
 NO: Minimumsavstand til brennbar materiale i armaturens stråleretning.
 SE: Minsta avstånd mellan brännbart material och lampans ljusrättning.
 FI: Vähimmäismitta lampusta palaavaan materiaaliin.