

SWITCH IP65 PRO

220-240V 50Hz IP65 IK08

EN: MEASUREMENT
 NO: MÅL
 SE: MÅTT
 FI: MITAT

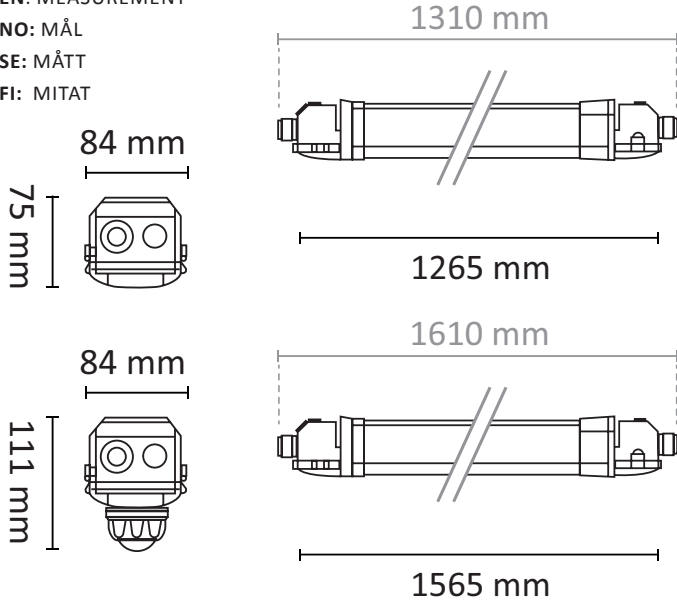

EN: This product contains a light source of energy efficiency class C
 NO: Dette produktet inneholder en LED-lyskilde med energieffektivitets-klasse C
 SE: Denna produkt innehåller en ljuskälla med energieffektivitetsklassen C
 FI: Tämä tuote sisältää LED -valonlähteen energiatehokkuus luokalla C

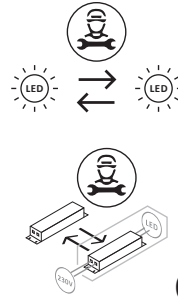

EN: Replaceable light source (LED only)/control gear by a professional.
 NO: Utskiftbar lyskilde/forkobling av autorisert el-installatør.
 SE: Utbytbar ljuskälla/drivdon av auktoriserad elektriker.
 FI: Vaihdeettava valonlähde/ajuri valtuutetun sähköasentajan toimesta.

OBS!

EN: Installation must be performed by a professional.
 NO: Må installeres av autorisert el-installatør.
 SE: Måste installeras av en behörig elektriker.
 FI: Vain valtuutettu sähköasentaja saa asentaa.

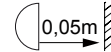

EN: Minimum distance to flammable material in the beam direction.
 NO: Minimumsavstand til brennbart materiale i armaturens stråleretning.
 SE: Minsta avstånd mellan brännbart material och lampans ljusrättning.
 FI: Vähimmäismitta valaisimesta palaavaan materiaaliin.

EN: ASSEMBLY
 NO: MONTERING
 SE: MONTERING
 FI: KIINNITYS

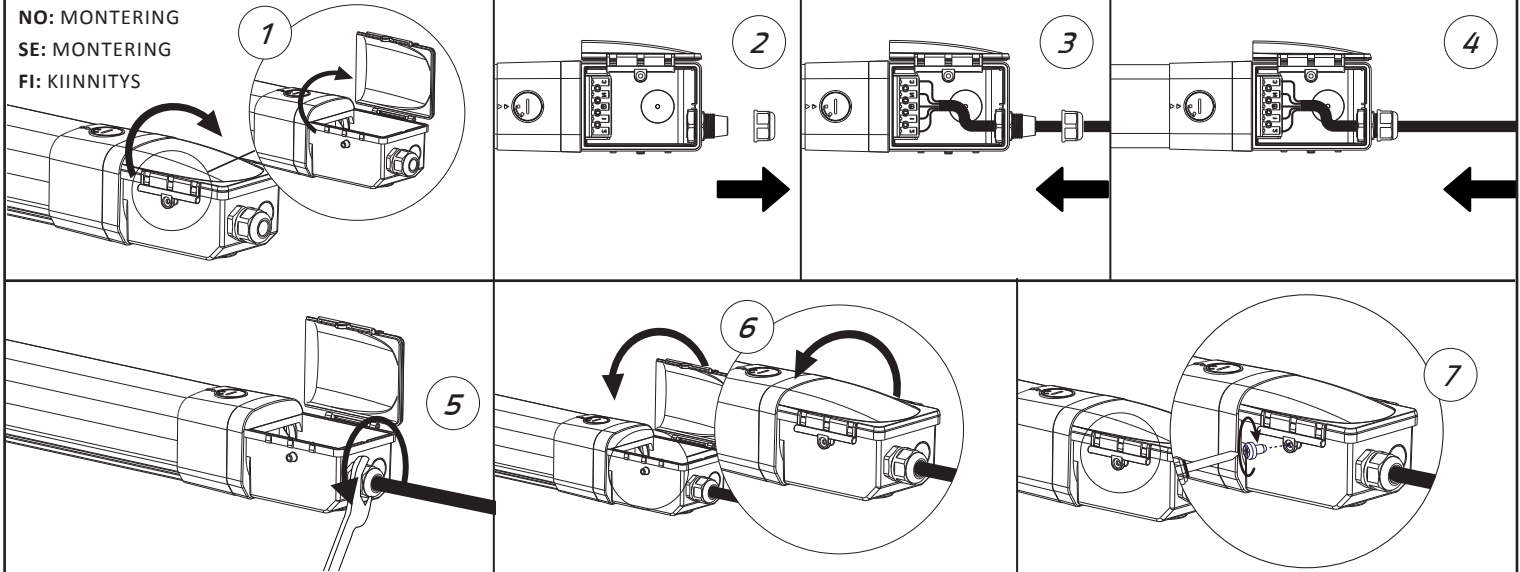

5 wires

DALI

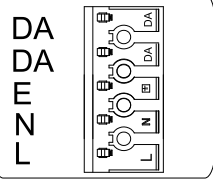
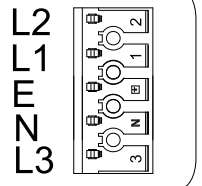

I rated [CC]	1	2
200mA	-	-
250mA	ON	-
300mA	-	ON
350mA	ON	ON

3000K → CCT adjustable → 4000K

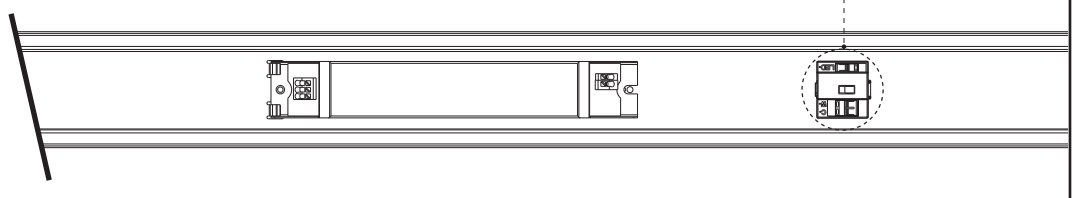
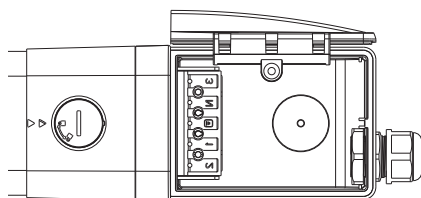

EN: MOUNTING
NO: MONTERING

SE: MONTERING
FI: ASENNUS

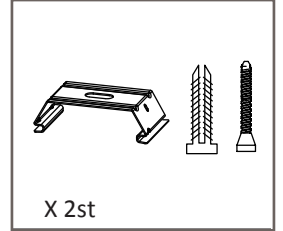
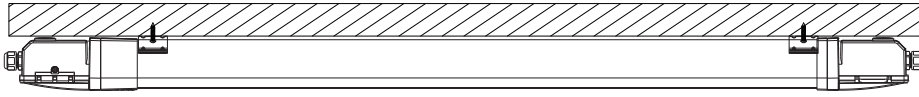

INCLUDED

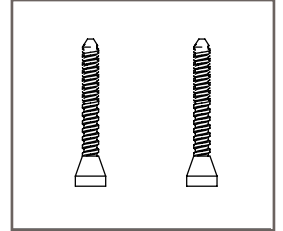
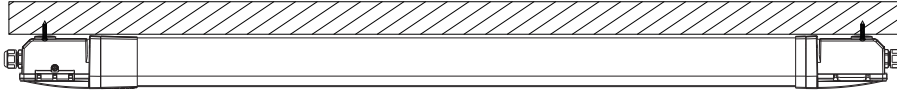

INCLUDED

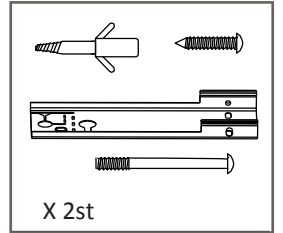
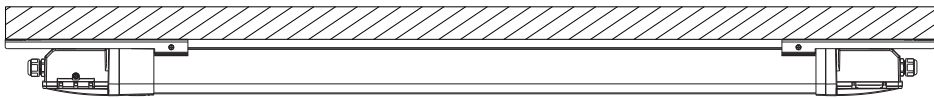

NO: 33 405 46
SE: 72 200 24

EN: WIRE SUSPENSION
NO: WIRE OPPHENG

SE: WIREUPPHÄNG
FI: VAIJERIRIPUSTUS

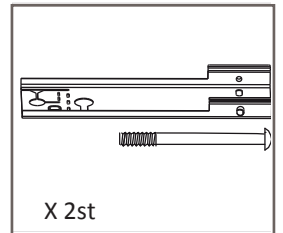
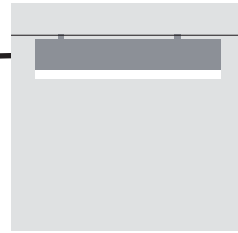
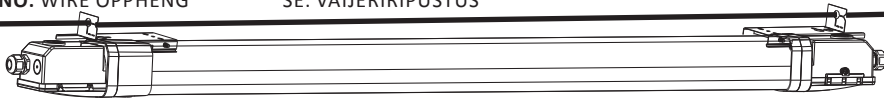

NO: 33 405 46
SE: 72 200 24

EN: DISASSEMBLY INSTRUCTION
NO: DEMONTERINGSINSTRUKSJON

SE: DEMONTERINGSINSTRUKTION
FI: PURKAMISOHJE

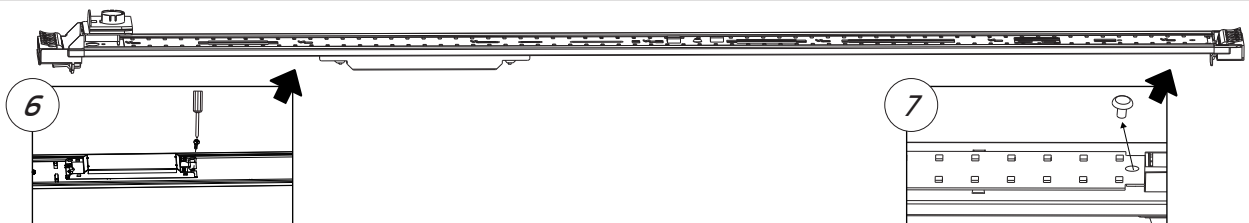
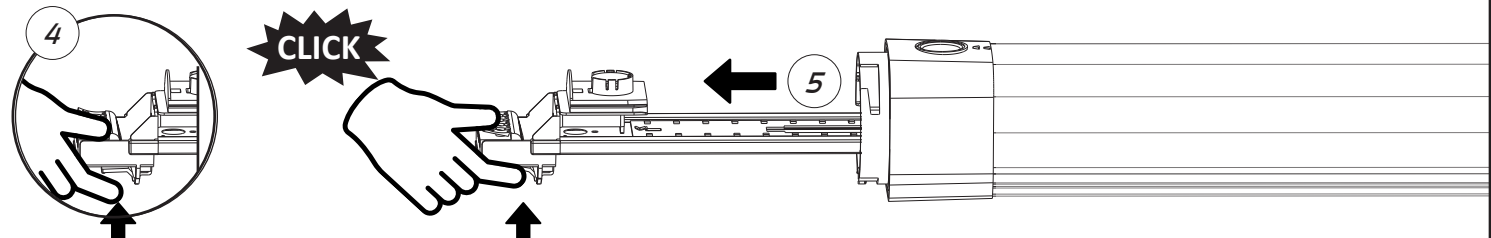

EN: SENSOR INSTALLATION

SE: SENSOR INSTALLATION

NO: SENSOR INSTALLASJON

FI: ANTURIN ASENNUS

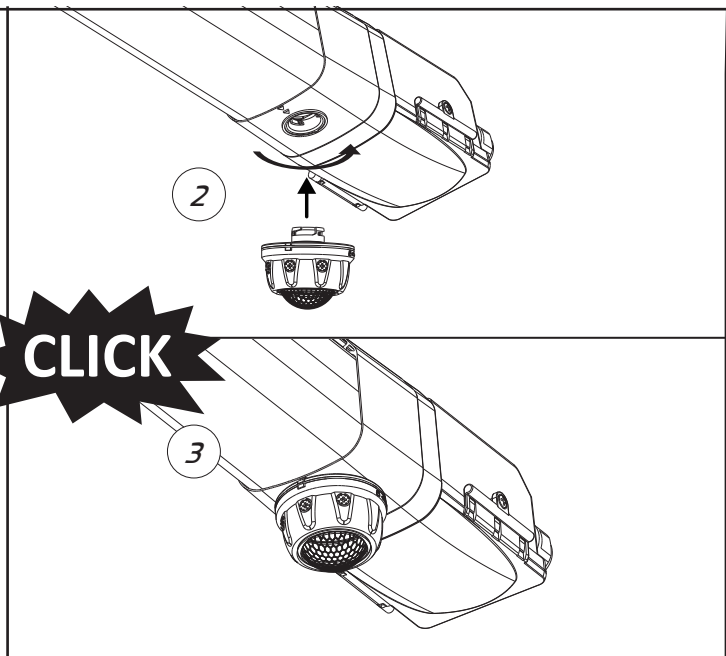
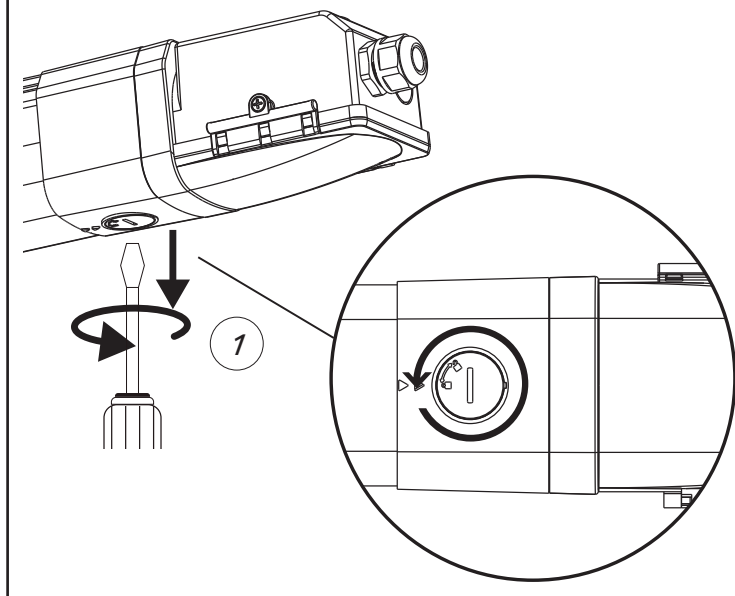

SWITCH IP65 PRO 1200 SETTINGS

Luminaire	Lumen	mA settings	Effect	Lifespan
Switch IP65 PRO 1200	3680lm	200mA	23W	100.000h
Switch IP65 PRO 1200	4480lm	250mA	28W	100.000h
Switch IP65 PRO 1200	5440lm	300mA	34W	100.000h
Switch IP65 PRO 1200	6400lm	350mA	40W	100.000h

RE-LAMPING GUIDE:

Luminaire replacement	Lumen	Total Effect (W)	Lifespan	Replacement	Total Lumen	mA settings	Total Effect (W)	Energy-saving	Lifespan	The number of lightsources which may be replaced through the LED lifespan	Light level compared to fluorescent
1x36W	1980lm	48W	10.000h	Switch IP65 PRO 1200	3680lm	200mA	23W	25W	100.000h	10	186%
2x36W	3960lm	94W	10.000h	Switch IP65 PRO 1200	4480lm	250mA	28W	66W	100.000h	20	113%
1x36W HF	1980lm	38W	14.000h	Switch IP65 PRO 1200	3680lm	200mA	23W	15W	100.000h	7	186%
2x36W HF	3960lm	74W	14.000h	Switch IP65 PRO 1200	4480lm	250mA	28W	46W	100.000h	14	113%
1X28W T5	2050lm	28W	16.000h	Switch IP65 PRO 1200	3680lm	200mA	23W	5W	100.000h	6	180%
2x28W T5	3660lm	56W	16.000h	Switch IP65 PRO 1200	3680lm	200mA	23W	33W	100.000h	13	101%
1x54W T5	3560lm	54W	16.000h	Switch IP65 PRO 1200	3680lm	200mA	23W	31W	100.000h	6	103%
2x54W T5	6450lm	108W	16.000h	Switch IP65 PRO 1200	6400lm	350mA	40W	68W	100.000h	13	99%

* For the calculation - a typical efficacy of a similar luminaire for fluorescent tubes are used

SWITCH IP65 PRO 1500 SETTINGS

Luminaire	Lumen	mA setting	Effect	Lifespan
Switch IP65 PRO 1500	5600lm	200mA	35W	100.000h
Switch IP65 PRO 1500	6880lm	250mA	43W	100.000h
Switch IP65 PRO 1500	8000lm	300mA	51W	100.000h
Switch IP65 PRO 1500	9600lm	350mA	60W	100.000h

RE-LAMPING GUIDE:

Luminaire replacement	Lumen	Total Effect (W)	Lifespan	Replacement	Total Lumen	mA settings	Total Effect (W)	Energy-saving	Lifespan	The number of lightsources which may be replaced through the LED lifespan	Light level compared to fluorescent
1x58W	3190lm	63W	10.000h	Switch IP65 PRO 1500	5600lm	200mA	35W	28W	100.000h	10	166%
2x58W	6380lm	126W	10.000h	Switch IP65 PRO 1500	6880lm	250mA	43W	83W	100.000h	20	105%
1x58W HF	3190lm	58W	14.000h	Switch IP65 PRO 1500	5600lm	200mA	35W	23W	100.000h	7	166%
2x58W HF	6380lm	116W	14.000h	Switch IP65 PRO 1500	8000lm	300mA	51W	73W	100.000h	14	105%
1x35W T5	2340lm	40W	16.000h	Switch IP65 PRO 1500	5600lm	200mA	35W	5W	100.000h	6	226%
2x35W T5	4150lm	80W	16.000h	Switch IP65 PRO 1500	5600lm	200mA	35W	45W	100.000h	13	127%
1x49W T5	3330lm	52W	16.000h	Switch IP65 PRO 1500	5600lm	200mA	35W	17W	100.000h	6	159%
2x49W T5	5920lm	104W	16.000h	Switch IP65 PRO 1500	8000lm	300mA	51W	61W	100.000h	13	114%
1x80W T5	5400lm	85W	16.000h	Switch IP65 PRO 1500	6880lm	250mA	43W	50W	100.000h	6	124%
2x80W T5	9620lm	170W	16.000h	Switch IP65 PRO 1500	9600lm	350mA	60W	110W	100.000h	13	100%

* For the calculation - a typical efficacy of a similar luminaire for fluorescent tubes are used

PRODUCT CODE:		PRODUCT:	SENSOR TYPE:		CONTROLLER / SETUP REMOTE	
Norway	Sweden		Microwave	PIR	Norway	Sweden
33 405 47	72 200 25	Switch PIR Sensor corridor function		X	33 405 55	72 201 10
33 405 48	72 200 26	Switch HF sensor corridor function	X		33 405 55	72 201 10
33 405 50	72 200 28	Switch Swarm sensor	X		33 405 56	72 201 11
33 405 55	72 201 10	Switch control unit for corridor function sensor	EN: For detailed functions, setup details, programming etc – please see the manual following the sensors. NO: For detaljerte funksjoner, oppsettsdetaljer, programmering etc – se bruksanvisningen etter sensorene. SE: För detaljerade funktioner, inställningsdetaljer, programmering etc – se manualen efter sensorerna.			
33 405 56	72 201 11	Switch control unit for Swarm sensor				

33 405 47	72 200 25	Switch PIR sensor corridor function
<p>EN: The sensor can be easily mounted in to fixing point in the luminaire's end cap. Remove the lid with a screwdriver. Twist the sensor to the integrated micro connector.</p> <p>The sensor settings are to be set by the Control Unit 33 405 55 / 72 201 10 via wireless radio signal when the luminaire is connected to mains power.</p> <p>Factory setting: Sensitivity 100%, Holdtime 3 seconds, Daylight disabled, Stand by period 0 seconds.</p>	<p>NO: Sensoren monteres enkelt i montasjepunktet i armaturens endestykke. Fjern lokket med en skrutrekk. Sensoren vris fast til den integrerte mikrokontakten. Sensorinnstillinger gjøres med Kontrollenheten 33 405 55 via et trådløst radiosignal når armaturen er tilkoblet nettspenning.</p> <p>Fabrikkinnstilling: Rekkevidde 100%, Etterlystid 3 sekunder, Dagslysbegrensere avslått, Grunnlys tid 0 sekunder</p>	<p>SE: Sensorn kan enkelt monteras i fästpunkten i armaturens gavel. Ta bort locket med en skruvmejsel. Vrid sensorn till den integrerade mikrokontakten.</p> <p>Sensorinställningarna ska ställas in av Styrenheten 72 201 10 via trådlös radiosignal när armaturen är ansluten till elnätet.</p> <p>Fabrikkinställning: Räckvidd 100 %, Efterlystid 3 sekunder, Dagsljusbegränsare avstängd, Grundljusjustid 0 sekunder</p>

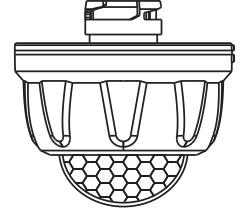

33 405 48	72 200 26	Switch HF Sensor corridor function
<p>EN: The sensor can be easily mounted in to fixing point in the luminaire's end cap. Remove the lid with a screwdriver. Twist the sensor to the integrated micro connector.</p> <p>The sensor settings are to be set by the Control Unit 33 405 55 / 72 201 10 via wireless radio signal when the luminaire is connected to mains power.</p> <p>Factory setting: Sensitivity 100%, Holdtime 3 seconds, Daylight disabled, Stand by period 0 seconds.</p>	<p>NO: Sensoren monteres enkelt i montasjepunktet i armaturens endestykke. Fjern lokket med en skrutrekk. Sensoren vris fast til den integrerte mikrokontakten. Sensorinnstillinger gjøres med Kontrollenheten 33 405 55 via et trådløst radiosignal når armaturen er tilkoblet nettspenning.</p> <p>Fabrikkinnstilling: Rekkevidde 100%, Etterlystid 3 sekunder, Dagslysbegrensere avslått, Grunnlys tid 0 sekunder</p>	<p>SE: Sensorn kan enkelt monteras i fästpunkten i armaturens gavel. Ta bort locket med en skruvmejsel. Vrid sensorn till den integrerade mikrokontakten.</p> <p>Sensorinställningarna ska ställas in av Styrenheten 72 201 10 via trådlös radiosignal när armaturen är ansluten till elnätet.</p> <p>Fabrikkinställning: Räckvidd 100 %, Efterlystid 3 sekunder, Dagsljusbegränsare avstängd, Grundljusjustid 0 sekunder</p>

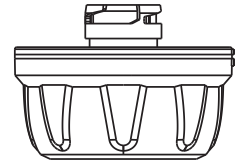

33 405 50	72 200 28	Switch SWARM sensor
<p>EN: Swarm sensor 3340550/7220028.</p> <p>The sensor can be easily mounted in to fixing point in the luminaire's end cap. Remove the lid with a screwdriver. Twist the sensor to the integrated micro connector. With the control unit, 3340556/7220111 you can set details for e.g. lighting group 1-8, range, afterglow time and level. In the event of defects, this control unit can retrieve settings from nearby sensors and send settings to a new fixture. Settings are sent to the luminaire/sensor with a wireless radio signal when the luminaire is connected to mains voltage.</p> <p>Factory setting: Sensitivity 100% Holdtime 5 seconds Daylight disabled Stand by period 0 seconds Stand by dim level 20%</p>	<p>NO: Swarm sensor 33 405 50 er en kommuniserende sensor. Denne monteres enkelt i montasjepunktet i armaturens endestykke. Med kontrollenheten 3340556 kan man stille inn detaljer for bl.a. belyningsgruppe 1-8, rekkevidde, etterlystid og nivå. Ved defekter kan denne kontrollenheten hente innstillinger fra nærliggende sensorer og sende innstillinger til ny armatur. Innstillinger sendes til armatur/sensor med et trådløst radiosignal når armaturen er tilkoblet nettspenning.</p> <p>Fabrikkinnstilling: Rekkevidde 100% Etterlystid 5 sekunder Dagslysbegrensere avslått Stand by tid 0 sekunder Grunnlys nivå 20%</p>	<p>SE: Swarm sensor 72 201 28 är en kommuniserande sensor som enkelt monteras i fästpunkten i armaturens gavel. Ta bort locket med en skruvmejsel. Vrid sensorn till den integrerade mikrokontakten. Med styrenheten 7220111 kan du ställa in detaljer för t.ex. ljusgrupp 1-8, räckvidd, efterlystid och nivå. Vid defekter kan denna styrenhet hämta inställningar från närliggande sensorer och skicka inställningar till en ny fixtur. Inställningar skickas till armaturen/sensorn med trådlös radiosignal när armaturen är ansluten till nätspänning.</p> <p>Fabrikkinställning: Räckvidd 100 % Efterlystid 5 sekunder Dagsljusbegränsare avstängd Standby-tid 0 sekunder Grundljusnivå 20%</p>

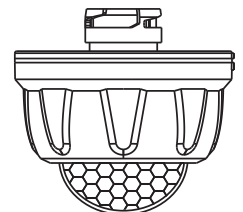

Switch control units
<p>EN: The control units are devices to do quick and simple setups and change of setups for the sensors. By do the setting on the controller unit and send a radio signal to the luminaires, a quick and easy setting may be done. There are two different control units, one for regular sensors and one more advanced for Swarm communicating sensor. Please read the instruction manual of the control unit for details.</p> <p>NO: Kontrollenhetene er enheter for å gjøre raske og enkle oppsett og endring av oppsett for sensorene. Ved å gjøre innstillingen på kontrollenheten og sende et radiosignal til armaturene, kan en rask og enkel innstilling gjøres.</p> <p>Det er to forskjellige kontrollenheter, en for vanlige sensorer og en mer avansert for Swarm-kommuniserende sensor. Les bruksanvisningen til kontrollenheten for detaljer.</p> <p>SE: Styrenheterna är enheter för att göra snabba och enkla inställningar och ändra inställningar för sensorerna. Genom att göra inställningen på styrenheten och skicka en radiosignal till armaturerna kan en snabb och enkel inställning göras.</p> <p>Det finns två olika styrenheter, en för vanliga sensorer och en mer avancerad för Swarm-kommuniserande sensor. Läs styrenhetens bruksanvisning för detaljer.</p>

