

Thermal overload relay T16



Thermal overload relays are economic electromechanical protection devices for the main circuit. They are used mainly to protect motors against overload and phase failures. Starter combinations are setup together with contactors.

Description

- Overload protection – trip class 10
- Phase loss sensitivity
- Temperature compensation from -25...+60 °C
- Adjustable current setting for overload protection
- Automatic or manual reset selectable
- Suitable for three- and single-phase application
- Trip-free mechanism
- Status indication
- STOP and TEST function
- Direct mounting onto mini contactors or block contactors



Order data

T16 screw terminal for B6/B7/VB6/VB7 mini contactors and for AS block contactors

Setting range	Type	Order code	Weight Pkg (1 pce) kg
A			
0.10...0.13	T16-0.13	1SAZ711201R1005	0.100
0.13...0.17	T16-0.17	1SAZ711201R1008	0.100
0.17...0.23	T16-0.23	1SAZ711201R1009	0.100
0.23...0.31	T16-0.31	1SAZ711201R1013	0.100
0.31...0.41	T16-0.41	1SAZ711201R1014	0.100
0.41...0.55	T16-0.55	1SAZ711201R1017	0.100
0.55...0.74	T16-0.74	1SAZ711201R1021	0.100
0.74...1.00	T16-1.0	1SAZ711201R1023	0.100
1.00...1.30	T16-1.3	1SAZ711201R1025	0.100
1.30...1.70	T16-1.7	1SAZ711201R1028	0.100
1.70...2.30	T16-2.3	1SAZ711201R1031	0.100
2.30...3.10	T16-3.1	1SAZ711201R1033	0.100
3.10...4.20	T16-4.2	1SAZ711201R1035	0.100
4.20...5.70	T16-5.7	1SAZ711201R1038	0.100
5.70...7.60	T16-7.6	1SAZ711201R1040	0.100
7.60...10.0	T16-10	1SAZ711201R1043	0.104
10.0...13.0	T16-13	1SAZ711201R1045	0.104
13.0...16.0	T16-16	1SAZ711201R1047	0.104

Suitable for mounting on: AS09 ... AS16, B6/BC6, B7/BC7, VB6/VBC6, VB7/VBC7

Approvals						Marks
A	K	E				P a
cULus UL 508	CB scheme	CCC	ABS	RINA	DNV	Lloyd's Register CE



1

2

3

4

5

6

7

8

Functional description

1. Terminals 1L1, 3L2, 5L3
2. Current setting range
Adjustable current setting for overload protection
3. Status indication
4. RESET button
Automatic or manual reset selectable
5. Signaling contacts 97-98
6. Terminals 2T1, 4T2, 6T3
7. Tripping contacts 95-96
8. STOP button

Application / internal function

The thermal overload relays are three pole relays with bimetal tripping elements (1 per pole). The motor current flows through the bimetal tripping elements and heats them directly and indirectly. In case of an overload (over current), the bimetal elements become bent as a result of the heating. This leads to a release of the relay and a change of the contacts switching position (95-96 / 97-98). The contact 95-96 is used to control the load contactor.

The overload relays have a setting scale in Amperes, which allows the direct adjusting of the relay without any additional calculation. In compliance with international and national standards, the setting current is the rated current of the motor and not the tripping current (no tripping at $1.05 \times I$, tripping at $1.2 \times I$; I = setting current). The relays are constructed in way that they protect themselves in the event of an overload. The overload relay has to be protected against short-circuit. The appropriate Short-circuit protective devices are shown in the table.

Operation mode

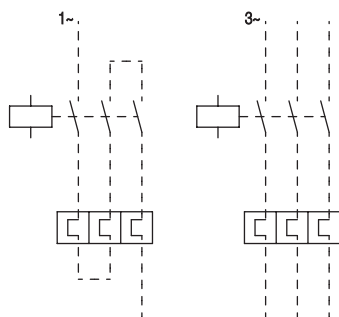

Wiring diagram

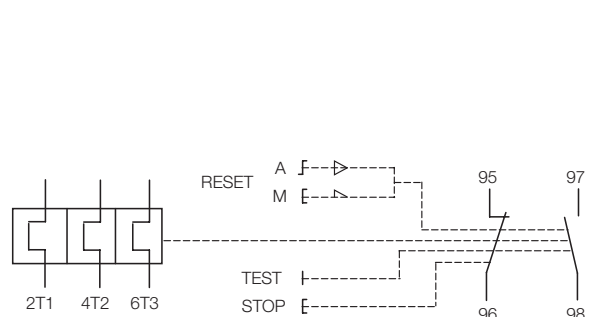

	Contact 95-96	Contact 97-98	Status indication	Comment
Trip state	open	closed		
RESET state	closed	open	ON	
TEST manual reset mode	open	closed		
TEST auto reset mode	open	closed		while TEST is operated
STOP while device is in trip state	open	closed		STOP button has no function
STOP while device is in RESET state	open	open		while STOP button is pressed

Resistance and power loss per pole and Short-circuit protective device

Type	Setting range		Resistance per pole	Power loss per pole		Short-circuit protection device coordination type 2
	lower value	upper value		at lower value	at upper value	
	A	A	Ω	W	W	
T16-0.13	0.10	0.13	106.51	1.1	2.0	0.5 A, Type T
T16-0.17	0.13	0.17	62.28	1.1	2.0	1.0 A, Type T
T16-0.23	0.17	0.23	37.43	1.1	2.0	1.0 A, Type T
T16-0.31	0.23	0.31	20.60	1.1	2.0	1.0 A, Type T
T16-0.41	0.31	0.41	11.42	1.1	2.0	2.0 A, Type gG
T16-0.55	0.41	0.55	6.35	1.1	2.0	2.0 A, Type gG
T16-0.74	0.55	0.74	3.62	1.1	2.0	4.0 A, Type gG
T16-1.0	0.74	1.00	1.920	1.1	2.0	6.0 A, Type gG
T16-1.3	1.00	1.30	1.065	1.1	2.0	6.0 A, Type gG
T16-1.7	1.30	1.70	0.623	1.1	2.0	10.0 A, Type gG
T16-2.3	1.70	2.30	0.340	1.1	2.0	10.0 A, Type gG
T16-3.1	2.30	3.10	0.187	1.1	2.0	10.0 A, Type gG
T16-4.2	3.10	4.20	0.102	1.1	2.0	20.0 A, Type gG
T16-5.7	4.20	5.70	0.059	1.1	2.0	20.0 A, Type gG
T16-7.6	5.70	7.60	0.031	1.1	2.0	35.0 A, Type gG
T16-10	7.60	10.00	0.0193	1.1	2.0	35.0 A, Type gG
T16-13	10.00	13.00	0.0131	1.3	2.2	40.0 A, Type gG
T16-16	13.00	16.00	0.0078	1.3	2.2	40.0 A, Type gG

Technical diagrams

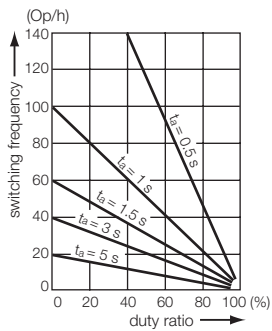

Intermittent periodic duty, t_a : Motor starting time

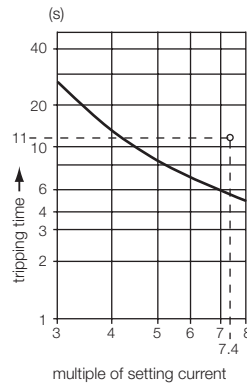

Example of a tripping curve, starting from cold state

Main dimensions

in mm, inches

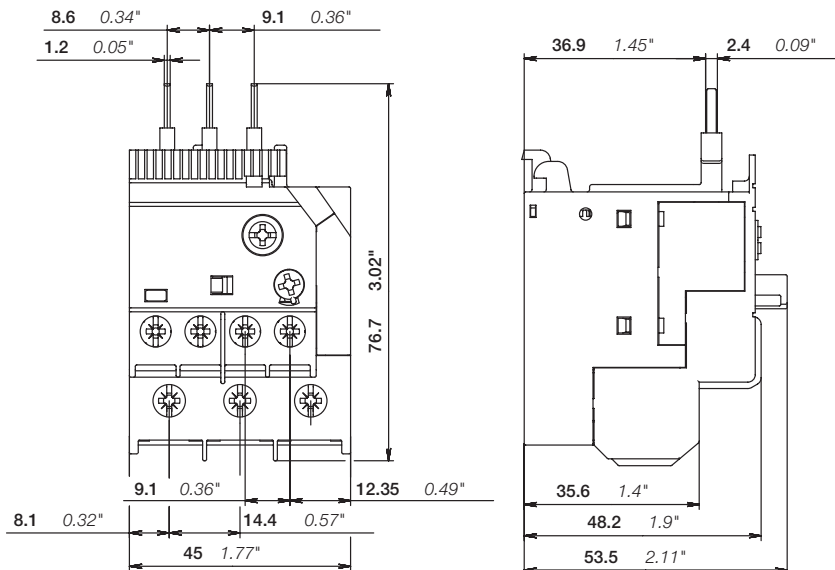





Technical data IEC/ENData at $T_A = 40\text{ °C}$ and at rated values, if nothing else indicated**Main circuit**

Terminal marking	2T1-4T2-6T3
Rated operational voltage U_e	690 V AC
	- V DC
Setting range - thermal overload protection	see table on page 1
Rated operational current AC-3 I_e	see upper value of setting range, see table on page 3
Trip class	10
Rated frequency	50/60 Hz
Frequency range	3
Number of poles	see table on page 3
Resistance per pole	see table on page 3
Power loss per pole	see table on page 3

Isolation data

Rated impulse withstand voltage U_{imp}	6 kV
Rated insulation voltage U_i	690 V
Pollution degree	3

Electrical connection

 solid	$1/2 \times 0.75 \dots 1.5 \text{ mm}^2$ $1/2 \times 1.5 \dots 4 \text{ mm}^2$
 stranded	$1/2 \times 1 \dots 4 \text{ mm}^2$
 flexible with ferrule	$1/2 \times 0.75 \dots 4 \text{ mm}^2$
 flexible with ferrule insulated	$1/2 \times 0.75 \dots 4 \text{ mm}^2$
 flexible without ferrule	$1/2 \times 0.75 \dots 4 \text{ mm}^2$
Stripping length	12 mm
Tightening torque	1.1...1.5 Nm
Recommended screw driver	M4 (Pozidriv 2)





Auxiliary circuit

Terminal marking	95-96, 97-98	
Rated operational voltage U_e	600 V	
Conventional free air thermal current I_{th}	N.C., 95-96	6 A
	N.O., 97-98	4 A
Rated frequency	DC, 50/60 Hz	
Number of poles	1 N.C. + 1 N.O.	
Rated operational current I_e acc. to IEC/EN 60947-5-1 for utilization category		
at AC-15 at 110-120 V	N.C., 95-96	3.00 A
	N.O., 97-98	0.5 A
at AC-15 at 220-230-240 V	N.C., 95-96	3.00 A
	N.O., 97-98	0.5 A
at AC-15 at 440 V	N.C., 95-96	0.75 A
	N.O., 97-98	0.5 A
at AC-15 at 480-500 V	N.C., 95-96	0.75 A
	N.O., 97-98	0.5 A
at DC-13 at 24 V	N.C., 95-96	1.25 A
	N.O., 97-98	1.25 A
at DC-13 at 110-120-125 V	N.C., 95-96	0.55 A
	N.O., 97-98	0.55 A
at DC-13 at 250 V	N.C., 95-96	0.27 A
	N.O., 97-98	0.27 A
at DC-13 at 500 V	N.C., 95-96	0.15 A
	N.O., 97-98	0.15 A
Minimum switching capacity	17 V / 3 mA	
Short-circuit protective device	N.C., 95-96	6 A, Type gG
	N.O., 97-98	4 A, Type gG

Isolation data

Rated impulse withstand voltage U_{imp} .	6 kV
Rated insulation voltage U_i	690 V
Pollution degree	3

Electrical connection

	solid	$1/2 \times 0.75 \dots 4 \text{ mm}^2$
	stranded	$1/2 \times 0.75 \dots 4 \text{ mm}^2$
	flexible with ferrule	$1/2 \times 0.75 \dots 2.5 \text{ mm}^2$
	flexible with ferrule insulated	$1 \times 0.75 \dots 2.5 \text{ mm}^2$ $2 \times 0.75 \dots 1.5 \text{ mm}^2$
	flexible without ferrule	$1/2 \times 0.75 \dots 1 \text{ mm}^2$ $1/2 \times 1 \dots 2.5 \text{ mm}^2$
Stripping length	9 mm	
Tightening torque	1...1.5 Nm	
Recommended screw driver	M3 (Pozidriv 2)	

General data

Duty time	100%	
Operating frequency without early tripping	up to 15 operations/h or 60 operations/h with 40% duty ratio, if the motor breaking current $6 \times I_n$ and the motor starting time does not exceed 1 s	
Dimensions (W x H x D)	see drawing "Dimensions" on page 3	
Weight	see table "Order data" on page 1	
Mounting	mount on the contactor and tighten the screws of the main circuit terminals or with single mounting kit on DIN rail (35 mm)	
Mounting position	position 1-5	
Minimum distance to other units same type	horizontal vertical	none not applicable
Minimum distance to electrical conductive board	horizontal vertical	none on request
Degree of protection	IP20	
Altitude	up to 2000 m	

Electromagnetic compatibility

Electromagnetic compatibility	not applicable
-------------------------------	----------------

Environmental data

Ambient air temperature		
Operation	open - compensated without derating	-25...+60 °C
	open	-25...+60 °C
Storage		-50...+80 °C
Ambient air temperature compensation		continuous
Resistance to vibrations acc. to IEC 60068-2-6 (Fc)		5g / 3...150 Hz
Resistance to shock acc. to IEC 60068-2-27(Ea)		25g / 11 ms

Standards / directives

Standards	IEC/EN 60947-4-1 IEC/EN 60947-5-1 IEC/EN 60947-1 UL 508, CSA 22.2 No. 14
Low Voltage Directive	2006/95/EC
EMC Directive	2004/108/EC
RoHS Directive	2005/95/EC

Technical data UL/CSA



Main circuit

Type	Full load amps (FLA)	Short-circuit protective device			
		480 / 600 V AC		480 / 600 V AC	
		SCCR	Fuse type	SCCR	Fuse type
T16-0.13	0.13 A	18 kA	1 A, K5	100 kA	30 A, Class J
T16-0.17	0.17 A	18 kA	1 A, K5	100 kA	30 A, Class J
T16-0.23	0.23 A	18 kA	1 A, K5	100 kA	30 A, Class J
T16-0.31	0.31 A	18 kA	3 A, K5	100 kA	30 A, Class J
T16-0.41	0.41 A	18 kA	3 A, K5	100 kA	30 A, Class J
T16-0.55	0.55 A	18 kA	3 A, K5	100 kA	30 A, Class J
T16-0.74	0.74 A	18 kA	3 A, K5	100 kA	30 A, Class J
T16-1.0	1.00 A	18 kA	6 A, K5	100 kA	30 A, Class J
T16-1.3	1.30 A	18 kA	6 A, K5	100 kA	30 A, Class J
T16-1.7	1.70 A	18 kA	6 A, K5	100 kA	30 A, Class J
T16-2.3	2.30 A	18 kA	10 A, K5	100 kA	30 A, Class J
T16-3.1	3.10 A	18 kA	10 A, K5	100 kA	30 A, Class J
T16-4.2	4.20 A	18 kA	15 A, K5	100 kA	30 A, Class J
T16-5.7	5.70 A	18 kA	20 A, K5	100 kA	30 A, Class J
T16-7.6	7.60 A	18 kA	25 A, K5	100 kA	30 A, Class J
T16-10	10.0 A	18 kA	35 A, K5	100 kA	45 A, Class J
T16-13	13.0 A	18 kA	40 A, K5	100 kA	45 A, Class J
T16-16	16.0 A	18 kA	60 A, K5	100 kA	45 A, Class J

Main circuit

Max. operational voltage	600 V AC
Trip rating	125% of FLA
Full load amps (FLA)	see table above
Short-circuit rating RMS symmetrical	see table above
Short-circuit protective device	see table above

Electrical connection

Connecting capacity	
 stranded	1/2 x AWG 18...10
 flexible without ferrule	1/2 x AWG 18...10
Stripping length	12 mm
Tightening torque	9...13 lb-in

Auxiliary circuit

Conventional thermal current	N.C., 95-96	5 A
	N.O., 97-98	2.5 A
Making and breaking capacity	N.C., 95-96	B600, Q300
	N.O., 97-98	D300, Q300

Electrical connection



Connecting capacity	
 stranded	1/2 x AWG 18...12
 flexible without ferrule	1/2 x AWG 18...12
Stripping length	9 mm
Tightening torque	9...13 lb-in



ABB STOTZ-KONTAKT GmbH
Electrification Business
Low Voltage Products and Systems
Eppelheimer Straße 82
D-69123 Heidelberg / Germany
Phone: +49 (0) 6221 7 01-0
Fax: +49 (0) 6221 7 01-13 25
E-Mail: info.desto@de.abb.com

**You can find the address of your local sales organization
on the ABB home page**
[https://new.abb.com/low-voltage/products/
motor-protection/manual-motor-starter](https://new.abb.com/low-voltage/products/motor-protection/manual-motor-starter)

We reserve the right to make technical changes or modify the contents of this document without prior notice. With regards to purchase orders, the agreed particulars shall prevail. ABB AG does not accept any responsibility whatsoever for potential errors or possible lack of information in this document.

We reserve all rights in this document and in the subject matter and illustrations contained therein. Any reproduction, disclosure to third parties or utilization of its contents – in whole or in parts – is forbidden without prior written consent of ABB AG.

Copyright© 2024 ABB - All rights reserved