

Manual motor starter magnetic only MO132

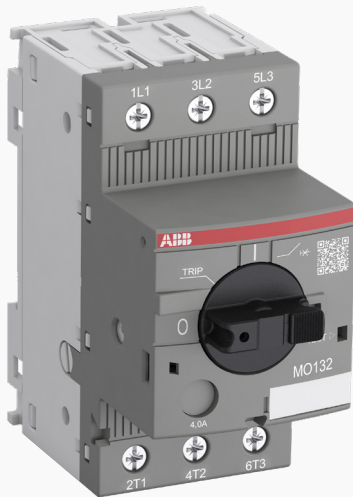

Manual motor starters magnetic only are electromechanical protection devices for the main circuit mainly used to switch motors manually ON/OFF and protect them fuseless against short-circuits.

Fuseless protection with a manual motor starter saves costs, space and ensures a quick reaction under short-circuit condition, by switching off the motor within milliseconds. Fuseless starter combinations are setup together with contactors and overload relays.

Description

- Short-circuit protection
- Disconnect function
- Suitable for three- and single-phase application
- Trip-free mechanism
- Clear switch position indication ON/OFF/TRIP
- Lockable handle



Order data

MO132 screw terminal

Setting range	Rated operational power 400 V AC-3, AC-3e kW	Type	Order code	Weight Pkg (1 pce) kg
A				
0.16	0.03 (1)	MO132-0.16	1SAM360000R1001	0.215
0.25	0.06	MO132-0.25	1SAM360000R1002	0.215
0.40	0.09	MO132-0.4	1SAM360000R1003	0.215
0.63	0.12	MO132-0.63	1SAM360000R1004	0.215
1.00	0.25	MO132-1.0	1SAM360000R1005	0.215
1.60	0.55	MO132-1.6	1SAM360000R1006	0.265
2.50	0.75	MO132-2.5	1SAM360000R1007	0.265
4.00	1.5	MO132-4.0	1SAM360000R1008	0.265
6.30	2.2	MO132-6.3	1SAM360000R1009	0.265
10.0	4.0	MO132-10	1SAM360000R1010	0.265
12.0	5.5	MO132-12	1SAM360000R1012	0.310
16.0	7.5	MO132-16	1SAM360000R1011	0.310
20.0	7.5	MO132-20	1SAM360000R1013	0.310
25.0	11	MO132-25	1SAM360000R1014	0.310
32.0	15	MO132-32	1SAM360000R1015	0.310

Note: For overload protection of motors, an appropriate thermal or electronic overload relay must be used.
(1) 690 V

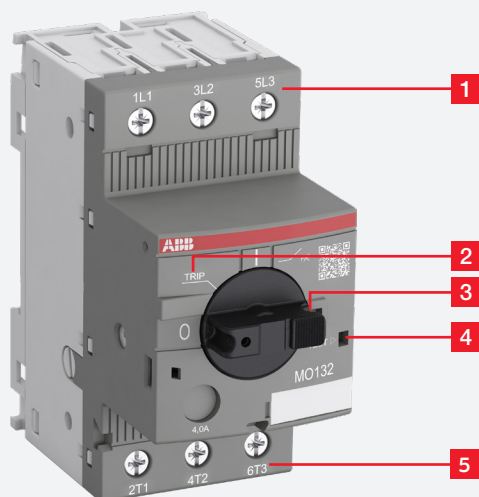

Functional description

1. Terminals 1L1, 3L2, 5L3
2. Switch position TRIP
3. Lockable handle
4. Test function
5. Terminals 2T1, 4T2, 6T3

Application

The manual motor starters magnetic only protect the load and the installation against short-circuit. They are three pole protection devices with electromagnetic tripping elements for short-circuit protection. Furthermore, they provide a disconnect function for safely isolation of the installation and the supply and can be used for the manual switching of loads.

For overload protection of the motors, an appropriate thermal or electronic overload relays must be used.

Operation mode

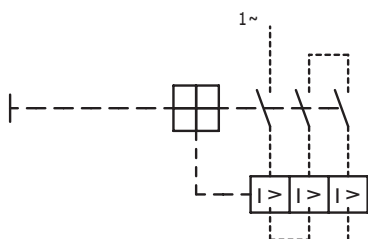

Single-phase operation

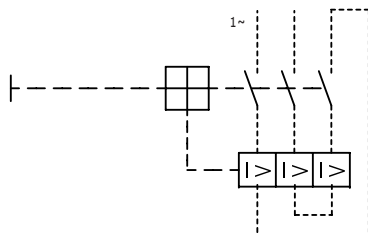

Single-phase operation

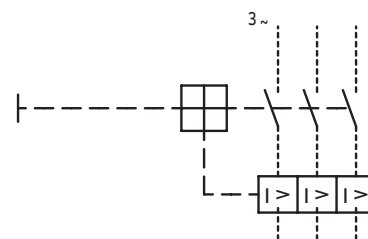

Three-phase operation

Wiring diagram

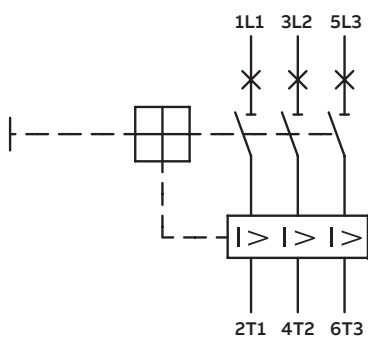

Power loss per pole

Type	Power loss per pole W
MO132-0.16	1.7
MO132-0.25	1.6
MO132-0.4	1.5
MO132-0.63	1.5
MO132-1.0	1.6
MO132-1.6	1.7
MO132-2.5	1.8
MO132-4.0	0.7
MO132-6.3	1.1
MO132-10	2.2
MO132-12	1.6
MO132-16	1.9
MO132-20	2.1
MO132-25	2.2
MO132-32	3.1

Main dimension

in mm / inches

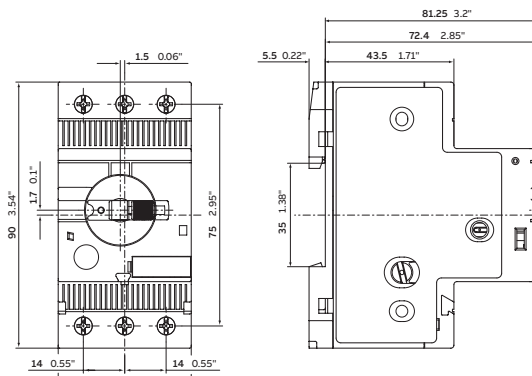

MO132 ≤ 10 A

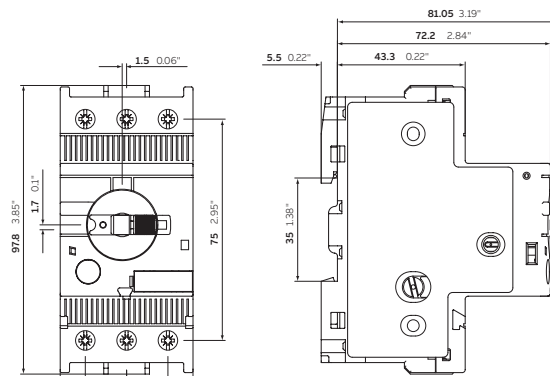

MO132 > 10 A

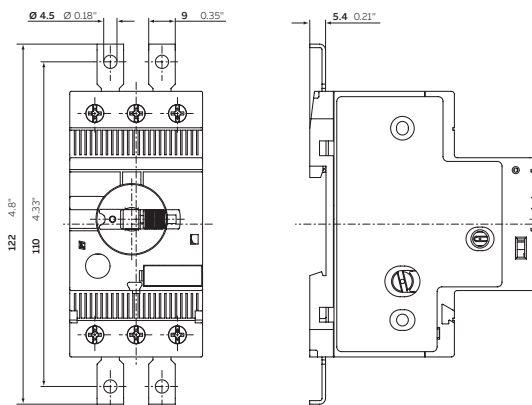

MO132 ≤ 10 A with screw fixing kit FS116 (accessory)

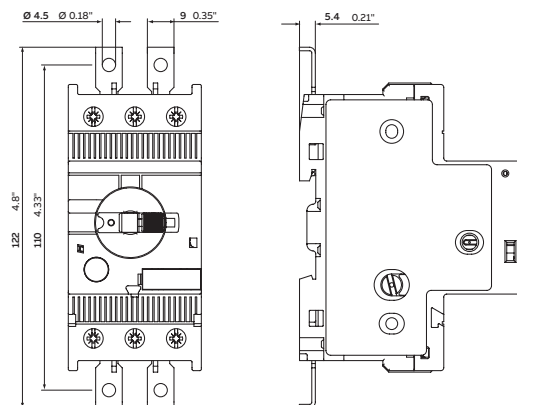

MO132 > 10 A + with screw fixing kit FS116 (accessory)

Technical data IEC/EN

Data at TA = 40 °C and at rated values, if nothing else indicated





Main circuit

Terminal marking	1L1-3L2-5L3 2T1-4T2-6T3
Rated operational voltage Ue	690 V AC
Rated operational current Ie	-
Rated operational current DC-5 3 conducting paths in series up to 250 V	see table below
Rated instantaneous short-circuit current setting Ii	-
Rated service short-circuit breaking capacity Ics	see table "Short-circuit breaking capacity and back-up fuses" on page 6
Rated ultimate short-circuit breaking capacity Icu	see table below
Rated frequency	50/60 Hz
Frequency range	0 ... 400 Hz
Number of poles	3
Power loss per pole	see table "Power loss per pole" on page 3

Isolation data

Rated impulse withstand voltage Uimp	6 kV
Rated insulation voltage Ui	690 V
Pollution degree	3

Electrical connection

Type		MO132 ≤ 10 A	MO132 ≥ 12 A
Connecting capacity			
 Rigid	1 or 2 x	1 ... 4 mm ²	1 ... 2.5 mm ² 2.5 ... 6 mm ²
 Flexible with ferrule	1 or 2 x	0.75 ... 2.5 mm ²	0.75 ... 6 mm ²
 Flexible with insulated ferrule	1 or 2 x	0.75 ... 2.5 mm ²	0.75 ... 6 mm ²
 Flexible	1 or 2 x	0.75 ... 2.5 mm ²	1 ... 2.5 mm ² 2.5 ... 6 mm ²
Stripping length		9 mm	10 mm
Tightening torque		0.8 ... 1.2 Nm / 10 ... 12 lb.in	2.0 Nm / 18 lb.in
Recommended screw driver		Pozidriv 2	Pozidriv 2

Type	Rated instantaneous short-circuit current setting Ii A	Rated operational current Ie A
MO132-0.16	2.00	0.16
MO132-0.25	3.13	0.25
MO132-0.4	5.00	0.40
MO132-0.63	7.88	0.63
MO132-1.0	12.50	1.00
MO132-1.6	20.00	1.60
MO132-2.5	31.25	2.50
MO132-4.0	50.00	4.00
MO132-6.3	78.75	6.30
MO132-10	125	10.0
MO132-12	150	12.0
MO132-16	200	16.0
MO132-20	250	20.0
MO132-25	313	25.0
MO132-32	400	32.0

General data

Mechanical durability		100 000
Electrical durability		50 000
Duty time		100 %
Dimensions (W x H x D)		see drawing "Dimensions" on page 3
Weight		see table "Order data" on page 1
Mounting		TH35-15 (35 x 15 mm Mounting Rail) acc. to IEC 60715 TH35-7.5 (35 x 7.5 mm Mounting Rail) acc. to IEC 60715
Mounting position		position 1-6 (optional for single mounting)
Group mounting		on request
Minimum distance to other units same type	horizontal	0 mm
	vertical	150 mm
Minimum distance to electrical conductive board	horizontal, up to 400 V	0 mm
	horizontal, up to 690 V	> 1.5 mm
	vertical	75 mm
Degree of protection	housing	IP20
	main circuit terminals	IP10
Utilization category		A
Maximum operating altitude		2000 m
Maximum operating frequency		170 cycles/h

Environmental data

Ambient air temperature		
Operation	open - compensated	-
	open	-25 ... +60 °C
	enclosed (IB132)	0 ... +40 °C
Storage		-50 ... +80 °C
Resistance to vibrations acc. to IEC 60068-2-6		5g / 3 ... 150 Hz
Resistance to shock acc. to IEC 60068-2-27		25g / 11 ms

Standards / directives

Standards	IEC/EN 60947-1 IEC/EN 60947-2 IEC/EN 60947-4-1 UL 60947-1 UL 60947-4-1 CSA-C22.2 No. 60947-1 CSA-C22.2 No. 60947-4-1
Low Voltage Directive	2014/35/EU
RoHS Directive	2011/65/EU

Short-circuit breaking capacity and back-up fuses

Ics Rated service short-circuit breaking capacity

Icu Rated ultimate short-circuit breaking capacity

Iq (Icc) Rated conditional short-circuit current

- No back-up fuse required, because short-circuit proof up to Icu (for Icu see table below)

Type	230 V AC			400 V AC			440 V AC			500 V AC			690 V AC		
	Ics kA	Icu kA	gG A	Ics kA	Icu kA	gG A	Ics kA	Icu kA	gG A	Ics kA	Icu kA	gG A	Ics kA	Icu kA	gG A
MO132-0.16	100	100	-	100	100	-	100	100	-	100	100	-	100	100	-
MO132-0.25	100	100	-	100	100	-	100	100	-	100	100	-	100	100	-
MO132-0.4	100	100	-	100	100	-	100	100	-	100	100	-	100	100	-
MO132-0.63	100	100	-	100	100	-	100	100	-	100	100	-	100	100	-
MO132-1.0	100	100	-	100	100	-	100	100	-	100	100	-	100	100	-
MO132-1.6	100	100	-	100	100	-	100	100	-	100	100	-	100	100	-
MO132-2.5	100	100	-	100	100	-	100	100	-	100	100	-	100	100	-
MO132-4.0	100	100	-	100	100	-	30	30	35 (1)	20	20	35 (1)	3	3	32 (1)
MO132-6.3	100	100	-	100	100	-	30	30	63 (1)	20	20	63 (1)	3	3	50 (1)
MO132-10	100	100	-	100	100	-	30	30	100 (1)	20	20	100 (1)	3	3	50 (1)
MO132-12	100	100	-	100	100	-	30	30	100 (1)	20	20	100 (1)	3	3	63 (1)
MO132-16	100	100	-	100	100	-	30	30	125 (1)	20	20	125 (1)	3	3	63 (1)
MO132-20	100	100	-	100	100	-	30	30	125 (1)	20	20	125 (1)	3	3	80 (1)
MO132-25	50	50	125 (1)	50	50	125 (1)	30	30	125 (1)	10	10	125 (1)	3	3	100 (1)
MO132-32	30	50	125 (1)	30	50	125 (1)	30	30	125 (1)	10	10	125 (1)	3	3	100 (1)

(1) Maximum rated current of the back-up fuse for short circuit up to 100kA if Icc > Ics

Technical data UL/CSA

Main circuit

Maximum operational voltage	600 V	
Manual motor controller ratings	see table "Manual motor controller for motor disconnect" on page 8	
Motor ratings	Horse power	see table below
	Full load amps (FLA)	see table below
	Locked rotor amps (LRA)	see table below

Electrical connection

Type	MO132 ≤ 10 A	MO132 > 12 A
Connecting capacity		
 Flexible without ferrule	1 or 2 x AWG 16 ... 12	AWG 16 ... 8
Stranded acc. to UL/CSA	1 or 2 x AWG 16 ... 12	AWG 16 ... 8
Stripping length	9 mm	10 mm
Tightening torque	0.8 ... 1.2 Nm / 10 ... 12 lb.in	2.0 Nm / 18 lb.in
Recommended screw driver	Pozidriv 2	

Note: For UL listed, use 75°C stranded Cu wire only.

UL/CSA Motor ratings, single phase

hp Horse power
 FLA Full load amps
 LRA Locked rotor amps

Type	110 - 120 VAC			200 Vac			208 Vac			220-240 V ac			440-480 VAC		
	hp	FLA	LRA	hp	FLA	LRA	hp	FLA	LRA	hp	FLA	LRA	hp	FLA	LRA
MO132-0.16	-	0.16	0.96	-	0.16	0.96	-	0.16	0.96	-	0.16	0.96	-	0.16	0.96
MO132-0.25	-	0.25	1.5	-	0.25	1.5	-	0.25	1.5	-	0.25	1.5	-	0.25	1.5
MO132-0.4	-	0.4	2.4	-	0.4	2.4	-	0.4	2.4	-	0.4	2.4	-	0.4	2.4
MO132-0.63	-	0.63	3.78	-	0.63	3.78	-	0.63	3.78	-	0.63	3.78	-	0.63	3.78
MO132-1.0	-	1	6	-	1	6	-	1	6	-	1	6	-	1	6
MO132-1.6	-	1.6	9.6	-	1.6	9.6	-	1.6	9.6	1/10	1.6	9.6	-	1.6	9.6
MO132-2.5	-	2.5	15	1/6	2.5	15	1/6	2.5	15	1/6	2.5	15	1/2	2.5	15
MO132-4.0	1/8	4	24	1/4	4.0	24	1/3	4	24	1/3	4	24	1	4	24
MO132-6.3	1/4	6.3	37.8	1/2	6.3	37.8	1/2	6.3	37.8	1/2	6.3	37.8	2	6	36
MO132-10	1/2	9.8	58.8	1	10	60	1	8.8	52.8	1 1/2	10	60	3	8.5	51
MO132-12	1/2	9.8	58.8	1 1/2	12	72	1 1/2	12	72	2	12	72	3	8.5	51
MO132-16	1	16	96	2	13.8	82.8	2	13.2	79.2	2	12	72	5	14	84
MO132-20	1 1/2	20	120	3	19.6	118	3	18.7	112	3	17	102	5	14	84
MO132-25	2	24	144	3	19.6	118	3	18.7	112	3	17	102	7 1/2	21	126
MO132-32	2	24	144	3	19.6	118	5	30.8	185	5	28	168	10	26	156

UL/CSA Motor ratings, three phase

Type	110-120 VAC			200 VAC			208 VAC			220-240 VAC			440-480 VAC			550-600 VAC		
	hp	FLA	LRA	hp	FLA	LRA	hp	FLA	LRA	hp	FLA	LRA	hp	FLA	LRA	hp	FLA	LRA
MO132-0.16	-	0.16	0.96	-	0.16	0.96	-	0.16	0.96	-	0.16	0.96	-	0.16	0.96	-	0.16	0.96
MO132-0.25	-	0.25	1.5	-	0.25	1.5	-	0.25	1.5	-	0.25	1.5	-	0.25	1.5	-	0.25	1.5
MO132-0.4	-	0.4	2.4	-	0.4	2.4	-	0.4	2.4	-	0.4	2.4	-	0.4	2.4	-	0.4	2.4
MO132-0.63	-	0.63	3.78	-	0.63	3.78	-	0.63	3.78	-	0.63	3.78	-	0.63	3.78	-	0.63	3.78
MO132-1.0	-	1	6	-	1	6	-	1	6	-	1	6	-	1	6	1/2	1	6
MO132-1.6	-	1.6	9.6	-	1.6	9.6	-	1.6	9.6	-	1.6	9.6	3/4	1.6	9.6	3/4	1.6	9.6
MO132-2.5	-	2.5	15	1/2	2.5	15	1/2	2.5	15	1/2	2.5	15	1	2.5	15	1 1/2	2.5	15
MO132-4.0	-	4	24	3/4	4	24	3/4	4	24	3/4	4	24	2	4	24	3	3.9	25.6
MO132-6.3	1/2	6.3	37.8	1	6.3	37.8	1	6.3	37.8	1 1/2	6.3	37.8	3	4.8	32	5	6.1	36.8
MO132-10	1	10	60	2	7.8	57.5	2	7.5	55	3	9.6	64	5	7.6	46	7 1/2	9	50.8
MO132-12	1 1/2	12	72	3	11	73.6	3	10.6	71	3	9.6	64	7 1/2	11	63.5	10	11	64.8
MOS132-16	2	16	84	3	11	73.6	3	10.6	71	5	15.2	92	10	14	81	10	11	64.8
MO132-20	3	19.2	128	5	17.5	105.8	5	16.7	102	5	15.2	92	10	14	81	15	17	93
MO132-25	3	19.2	128	5	17.5	105.8	7 1/2	24.2	140	7 1/2	22	127	15	21	116	20	22	116
MO132-32	5	30.4	184	7 1/2	25.3	146	10	30.8	179	10	28	162	20	27	145	25	27	146

UL/CSA Maximum short-circuit current ratings – MO132

Type	Manual Motor Controllers							
	Branch circuit protection, max. size per NEC/CEC (1)		for motor disconnect		for group installations		for tap conductor protection in group installations	
	Fuses	Circuit breaker	480 V	600 V	480 V	600 V	480Y / 277 V	600Y / 347 V
A	A	kA	kA	kA	kA	kA	kA	
MO132-0.16	Any Listed fuses. Size per NEC/CEC	Any Listed UL489 / CSA C22.2 No.5 circuit breaker. Size per NEC/CEC	65	47	65	47	65	47
MO132-0.25			65	47	65	47	65	47
MO132-0.4			65	47	65	47	65	47
MO132-0.63			65	47	65	47	65	47
MO132-1.0			65	47	65	47	65	47
MO132-1.6			65	47	65	47	65	47
MO132-2.5			65	47	65	47	65	47
MO132-4.0			65	47	65	47	65	47
MO132-6.3			65	18	65	18	65	18
MO132-10			65	18	65	18	65	18
MO132-12			30	18	30	18	30	18
MO132-16			30	18	30	18	30	18
MO132-20			30	18	30	18	30	18
MO132-25			30	18	30	18	30	18
MO132-32			30	18	30	18	30	18

(1) NEC: NFPA®70 National Electrical Code®; CEC: CSA C22.1 Canadian Electrical Code.

UL/CSA Maximum short-circuit current ratings – MO132 with electronic overload relays and AF contactors

Type	EOL	Combination Motor Controllers (Type F) (1)		
		Coordination type 1 Minimum contactor size	480Y / 277 V kA	600Y / 347 V kA
MO132-0.16	EF19	AF09 ... AF38	100	50
MO132-0.25	EF19	AF09 ... AF38	100	50
MO132-0.4	EF19	AF09 ... AF38	100	50
MO132-0.63	EF19	AF09 ... AF38	100	50
MO132-1.0	EF19	AF09 ... AF38	100	50
MO132-1.6	EF19	AF09 ... AF38	100	50
MO132-2.5	EF19	AF09 ... AF38	100	50
MO132-4.0	EF19	AF09 ... AF38	100	50
MO132-6.3	EF19	AF09 ... AF38	100	50
MO132-10	EF19	AF09 ... AF38	100	30
MO132-12	EF19	AF09 ... AF38	65	30
MO132-16	EF19	AF12 ... AF38	65	30
MO132-20	EF19	AF16 ... AF38	65	–
MO132-25	EF45-30	AF26 ... AF38	50	–
MO132-32	EF45-45	AF38	50	–

(1) In combination with feeder block S1-M3-xx or terminal spacer TS1-M3-S1 (for 0.16 ... 10 A) / TS1-M3-S2 (for 12 ... 32 A).

UL/CSA Maximum short-circuit current ratings – MO132 with thermal overload relays and AF contactors

Type	TOL	Combination Motor Controllers (Type F) (1)		
		Coordination type 1 Minimum contactor size		
			480Y / 277 V kA	600Y / 347 V kA
MO132-0.16	TF42	AF09... AF38	65	50
MO132-0.25	TF42	AF09... AF38	65	50
MO132-0.4	TF42	AF09... AF38	65	50
MO132-0.63	TF42	AF09... AF38	65	50
MO132-1.0	TF42	AF09... AF38	65	50
MO132-1.6	TF42	AF09... AF38	65	50
MO132-2.5	TF42	AF09... AF38	65	50
MO132-4.0	TF42	AF09... AF38	65	50
MO132-6.3	TF42	AF09... AF38	65	47
MO132-10	TF42	AF09... AF38	65	30
MO132-12	TF42	AF09... AF38	65	30
MOS132-16	TF42	AF26... AF38	65	30
MO132-20	TF42	AF26... AF38	65	30
MO132-25	TF42	AF26... AF38	50	30
MO132-32	TF42	AF38	50	30

(1) In combination with feeder block S1-M3-xx or terminal spacer TS1-M3-S1 (for 0.16 ... 10 A) / TS1-M3-S2 (for 12 ... 32 A).

UL/CSA Maximum short-circuit current ratings – MO132 with electronic overload relays and AF contactors

Type	EOL	Combination Motor Controllers (Type F) (1)		
		Coordination type 1 Minimum contactor size		
			480Y / 277 V kA	600Y / 347 V kA
MO132-0.16	EF19	AF26... AF38	65	47
MO132-0.25	EF19		65	47
MO132-0.4	EF19		65	47
MO132-0.63	EF19		65	47
MO132-1.0	EF19		65	47
MO132-1.6	EF19		65	47
MO132-2.5	EF19		65	47
MO132-4.0	EF19		65	47
MO132-6.3	EF19		65	47
MO132-10	EF19		65	47
MO132-12	EF19		30	-
MOS132-16	EF19		30	-
MO132-20	EF19		30	-
MO132-25	EF45 - 30		30	-
MO132-32	EF45 - 45	30	-	

(1) In combination with feeder block S1-M3-xx or terminal spacer TS1-M3-S1 (for 0.16 ... 10 A) / TS1-M3-S2 (for 12 ... 32 A).

NOTE : More coordination tables are available in our SOC (selected optimized coordination) tool:

<https://applications.it.abb.com/SOC/Motor>.



ABB STOTZ-KONTAKT GmbH
Eppelheimer Straße 82
69123 Heidelberg, Germany
Phone: +49 (0) 6221 7 01-0
Fax: +49 (0) 6221 7 01-13 25
E-Mail: info.desto@de.abb.com

abb.com/contacts

We reserve the right to make technical changes or modify the contents of this document without prior notice. With regards to purchase orders, the agreed particulars shall prevail. ABB AG does not accept any responsibility whatsoever for potential errors or possible lack of information in this document.

We reserve all rights in this document and in the subject matter and illustrations contained therein. Any reproduction, disclosure to third parties or utilization of its contents – in whole or in parts – is forbidden without prior written consent of ABB AG.

Copyright© 2024 ABB - All rights reserved

2CDC131035D0202 - Rev D (01.2024)