

MAIN CATALOG

PLC Automation

PLCs, Control Panels, Engineering Suite
AC500, CP600, ABB Ability™ Automation Builder



PLC Automation

PLCs, Control Panels, Engineering Suite

APPLICATION
DESCRIPTIONS
AND FEATURES

ABB ABILITY™
AUTOMATION BUILDER
INTEGRATED
ENGINEERING SUITE

002–059 **PLC Automation product family**

AC500-ECO
ENTRY LEVEL PLC
SOLUTIONS

060–097 **Application descriptions and
features**

098–113 **ABB Ability™ Automation
Builder
Integrated engineering suite**

AC500
HIGH PERFORMANCE
MODULAR PLC

114–139 **AC500-eCo
Entry level PLC solutions**

140–191 **AC500
High performance modular PLC**

AC500-XC
PLC OPERATING IN
EXTREME CONDITIONS

192–239 **AC500-XC
PLC operating in eXtreme
Conditions**

AC500-S
FUNCTIONAL
SAFETY PLC

240–253 **AC500-S
Functional safety PLC**

254–263 **CP600-eCo, CP600 and
CP600-Pro Control panels**

CP600-ECO, CP600
AND CP600-PRO
CONTROL PANELS

264–291 **Additional information**

292–299 **Index**

ADDITIONAL
INFORMATION

PLC Automation product family

004–007	Overview
008–009	ABB solutions for various applications
010–011	Connectivity
012–015	ABB Ability™ Automation Builder
016–017	AC500 libraries and software
018–021	PLCs at a glance ...
022–023	AC500 V2 CPU Selector
024–025	AC500 V3 CPU Selector
026	AC500-eCo – modular concept
027	AC500 and AC500-XC – modular concept
028–029	S500 I/O system – modular concept
030–031	AC500-eCo V3 system characteristics
032–033	AC500-eCo V3 overview
034–035	AC500 system characteristics
036–037	AC500 PM595 controller system characteristics
038–039	Condition monitoring system CMS based on AC500
040–041	AC500 V3 enhanced connectivity and performance
042–043	AC500 extreme conditions
044–045	AC500-S safety PLC – functional safety
046	Visualization options
047–048	PB610 Panel Builder 600
049	CP600 connectivity
050	CP600 control panel platform at a glance ...
051	What does your application need?
052–053	CP600-eCo control panels
054–055	CP600 control panels
056–057	CP600-Pro control panels
058–059	PLC Automation website – online tools

PLC Automation product family

Overview

ABB offers a comprehensive range of scalable PLCs and robust HMI control panels. Since its launch, the AC500 PLC platform has achieved significant industry recognition for delivering high performance, quality and reliability.



Comprehensive range

- ABB delivers scalable, flexible and efficient ranges of automation components to fulfill all conceivable requirements of the most diverse automation applications.
- ABB's automation devices deliver solutions with high performance and flexibility to be effectively deployed within various industries and applications including water, building infrastructure, data centers, renewable energy, machinery automation, material handling, marine and many more.

Engineering suite

- ABB Ability™ Automation Builder is the integrated software suite for machine builders and system integrators requiring state-of-the-art productive machine and system automation.
- Combining the tools required for configuring, programming, debugging and maintaining automation projects from one common intuitive interface, Automation Builder addresses the largest single cost element of most of today's industrial automation projects - software.





Programmable Logic Controllers PLCs

- The AC500-eCo, AC500, AC500-XC and AC500-S scalable PLC ranges provide solutions for small, medium and high-end applications.
- Our AC500 PLC platform offers different performance levels and is the ideal choice for high availability, extreme environments, condition monitoring, motion control or safety solutions.
- Our AC500 PLC platform offers interoperability and compatibility in hardware and software from compact PLCs up to high end and safety PLCs.

Control panels

- CP600-eCo, CP600 and CP600-Pro control panels in combination with the PB610 Panel Builder 600 offer a wide range of features and functionalities for maximum operability.
- ABB control panels are distinguished by their robustness and easy usability, providing all the relevant information from production plants and machines at one single touch.



PLC Automation product family

Overview

Engineering suite



ABB Ability™ Automation Builder

- Connects the engineering tools for PLC, safety, control panels, drives and motion control.
- Combines the tools required for configuring, programming, debugging and maintaining automation projects from one common intuitive interface.



Library packages

- For efficient engineering of demanding applications.
- Easy-to-use application examples.

Visualization



CP600-eCo

- Economical control panel aimed for standard functions and high usability for clear interaction with the operation process.

Programmable Logic Controllers PLCs



AC500-eCo

- Compact PLC for economical automation solutions and motion control in smaller applications.
- Integrates seamlessly into the broader AC500 PLC platform.

I/O modules



S500-eCo

- Range of modular I/Os for economical configurations in smaller applications.
- Connected directly to the AC500 or AC500-eCo CPU modules.
- S500-eCo I/O modules can be mixed with standard S500 modules.
- Usage as remote I/O with fieldbus communication interface modules.



CP600

- Robust HMI with high visualization performance, versatile communication and representative design for machines and systems.



CP600-Pro

- HMI with high end visualization performance, multi-touch operation, versatile communication and representative design, partly usable to trigger safety actions with AC500-S.



AC500

- Powerful PLC featuring a wide range of performance, communications and I/O capabilities for industrial applications.
- For complex, high-speed machinery, motion control and networking solutions.



AC500-XC

- Extreme condition PLC variant.
- With extended operating temperature, immunity to vibration and corrosive gases, for use at high altitudes and in humid environments.



AC500-S

- Integrated safety PLC (SIL3, PL e) for safety applications in factory, machinery or process automation area.
- For simple and complex safety solutions.



S500

- Range of modular I/O with protected outputs and comprehensive diagnosis, covering a wide range of signal types.
- Installed as remote I/O with a communication interface module or directly connected to the AC500 CPU.
- Support of different fieldbuses to use the S500 I/O modules with PLCs from different manufacturers.



S500-XC

- Extreme condition S500 I/O variant.
- With extended operating temperature, immunity to vibration and corrosive gases, for use at high altitudes and in humid environments.



S500-S

- Safety S500 I/O variant.
- Extreme condition variants available.

PLC Automation product family

ABB solutions for various applications



Variable speed drives

Widest selection with scalable possibilities.

- Boosts productivity and energy efficiency, and cuts maintenance costs
- Scalable drives portfolio from micro, machinery and general purpose drives, to industrial drives and industry-specific drives
- Available directly from stock or can be built to order to meet more complex requirements
- Life cycle services to ensure exact operation of the processes, year after year



Motors

For optimal application control.

- Wide range of low voltage and medium voltage motors
- Reaches efficiency and energy saving levels even under the most demanding conditions
- Designed to operate reliably with low life cycle costs



ACS880 for speed, torque or position control

For almost any power and application.

- High accuracy and advanced functionality for wide power range and several variants. Ideal solution for almost any application from positioning applications like stacker cranes, metal presses, rotary tables and cutting systems to demanding open loop applications like winches
- Same user interface and hardware for the positioning controlled and the speed/torque controlled drives simplifying the engineering and use
- Ready made, embedded motion control functions eliminating the need for external position controllers

Performance

Efficiency

Accuracy

Discover our drives, motors and PLCs



new.abb.com/drives



new.abb.com/motors-generators



Scalability

Programmable Logic Controllers PLCs For high performance and flexibility.

- The AC500 PLC platform provides solutions for small, medium and high-end applications
- ABB's AC500 PLC and control panel portfolio provides a high number of scalable products, communication protocols and connectivity options, from the field layer right through to the management and visualization layers



Usability

HMI (human-machine interface) Clear in touch with productivity.

- The CP600 control panel platform is harmonized with AC500 PLCs and ABB Ability™ Automation Builder software
- Scalable solutions from basic CP600-eCo functionalities to premium CP600-Pro
- Easy programming with predefined customizable widgets



Engineering

ABB Ability™ Automation Builder Next level engineering efficiency.

- Automation Builder integrates engineering tools for PLCs, safety, drives, motion and control panels
- Manage complexity and realize connectivity easily
- One common intuitive interface for configuring, programming, debugging and maintaining automation projects



Productivity

Machinery drives

Persistent and adaptable performance.

- Designed to offer high performance, adaptability and reliable operation
- The units can be configured and optimized to match exactly the customer's needs with a great motor control accuracy and performance
- Part of all-compatible product family
- Designed specifically for machine builders and system integrators



PLC Automation product family

Connectivity

ABB's PLC and control panel portfolio provides a high number of scalable products, communication protocols and connectivity options, from the field layer right through to the management and visualization layers.

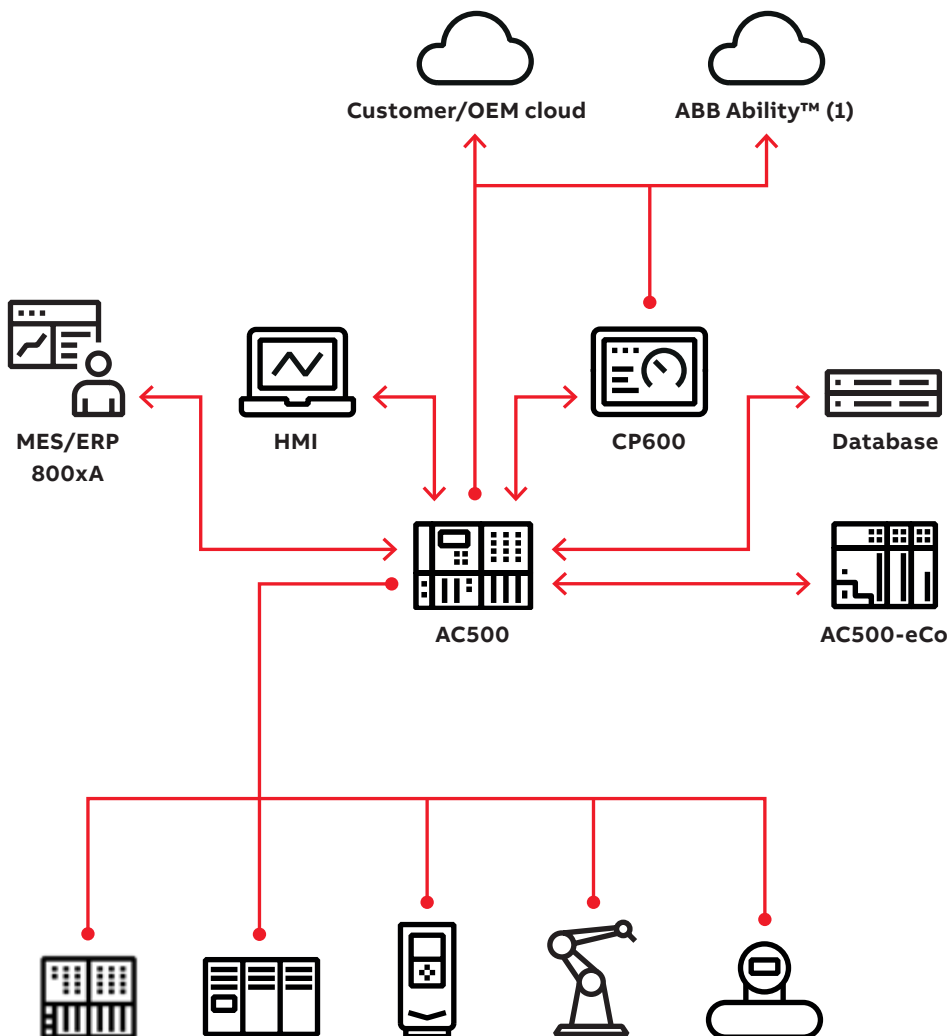

IT network/Internet

- FTP(S)
- HTTP(S)
- MQTT
- NTP/SNTP
- OPC UA
- SMTP(S)

Factory/site network

- BACnet
- DNP3 (1)
- FTP(S)
- HTTP(S)
- IEC 60870-5-104
- IEC 61850
- KNX
- MySQL/MSSQL
- NTP/SNTP
- OPC DA/AE
- OPC UA
- SNMP
- TCP/IP
- UDP

Control network

- CANopen
- CAN 2A/2B
- DNP3 (1)
- EtherCAT
- Ethernet/IP
- IEC 60870-5-104
- IEC 61850
- Modbus RTU
- Modbus TCP
- PROFIBUS DP
- PROFINET/PROFIsafe
- SAE J1939

(1) In preparation



Protocol	Application
Connector to SQL Database	Save to or get data from MSSQL or MySQL databases
DNP3 (1)	Telecontrol in distributed plants such as water, solar, power infrastructure (outstation)
FTP(S)	Server and client for secure and efficient exchange of big data
HTTP Request	Request information like temperature, humidity etc. from devices with web server functionality
HTTP(S)	Publish HTML5 websites for monitoring and control
IEC 60870-5-104	Telecontrol in distributed plants such as water, solar, power infrastructure (control- and substation)
IEC 61850	Mainly used in the electrification part of infrastructure projects
KNX/BACnet	Standard protocols used in building and infrastructure automation projects
MQTT	Certificated based publishing of data to private clouds for dashboards or data analytics
OPC DA/AE/UA	Connectivity for SCADA, DCS and management applications
SNTP/SNMP	Protocol for time synchronization, network supervision and configuration
UDP and TCP/IP	Implement specific and efficient own communication

PLC Automation product family

ABB Ability™ Automation Builder

Engineering productivity for machine builders and system integrators.



Product license options

	Automation Builder Basic	Automation Builder Standard	Automation Builder Premium
Free	●		
AC500-eCo	●	●	●
AC500 with local I/O & network (1)	●	●	●
AC500 with fieldbus (2)		●	●
AC500-S Safety		○	○
Drive Manager		●	●
Drive application programming (3)	●	●	●
Motion programming	● (4)	●	●
Panel Builder 600	○	●	●
Panel Builder 600 Basic	●	●	●
Integrated engineering (5)		●	●
Productivity features (6)			●
Additional features (7)		○	○

- fully
- partly

(1) TCP protocols, Modbus, IEC 60870-5-104, CS31

(2) PROFIBUS, PROFINET, EtherCAT, CAN

(3) Drive application programming for drives with embedded PLC (only available with Automation Builder 2.1 and before). Drive Composer pro license included in Standard and Premium Edition.

(4) No fieldbus connectivity in Automation Builder Basic

(5) PLC, Safety, Panel, Drive, Motion, SCADA

(6) C/C++, ECAD data exchange, CSV interface extensions, project compare, project scripting

(7) Advanced simulation support for virtual system testing, Professional Developer Tools e.g. for multi-user engineering or static code analysis



Discover engineering productivity when designing your automation solutions

Automation Builder is ABB's integrated programming, simulation, commissioning and maintenance environment for PLCs, safety, drives, motion, control panels and SCADA. Automation Builder combines the proven ABB tools Drive Manager, Drive composer pro, Mint WorkBench, Panel Builder and ABB zenon.

Always get the right scope of Automation Builder for your automation solutions

One single software installer helps you to create and maintain your personal Automation Builder configuration - either on your PC or on a server. Any changes or updates are just a matter of a few mouse clicks.

The Automation Builder licensing system is designed for supporting most operation scenarios. Licenses can be installed on PCs, USB dongles or license servers. In case of changes in the organization or in the engineering workflows the licenses can easily be transferred to where you need them.

Next level engineering efficiency

Improve your engineering efficiency by maximizing data re-use. Data that is available from third party tools can be imported or synchronized, either via dedicated interfaces or generic Excel sheets. Configurations that have been created for the PLC can automatically be re-used e.g. for the configuration of drives or operator panels.

Engineering efforts can be reduced further by using easy-to-use libraries e.g. for wind, water, solar, drives, motion, robotics, safety and building automation applications. And in case building blocks are missing for your automation solution simply create them yourself. Project scripting allows you to automate the creation of any part of your configuration or application.

The quality of the resulting PLC application can be automatically checked by static code analysis. More than 100 pre-defined rules can be used to define and keep the quality level that is required for your business.

PLC Automation product family

ABB Ability™ Automation Builder

Fast track to comprehensive applications

For creating the application code all five IEC 61131-3 languages can be used. This opens up access to a large community of developers sharing proven code snippets. Even existing PC based functions or protocols can be re-used by using the C/C++ integration. Furthermore, Simulink models and MATLAB functions can be used as well by converting them to PLC code.

Minimized efforts for project code and data administration

Configure and program all devices of your automation solution in one single project. This makes it easy to share your solutions with others. For more advanced usage the integrated version control system supports further scenarios like multi-user engineering or product line management.

Managing the life-cycle of your automation solutions is also easy. The annual Automation Builder release also supplies you with the latest versions of device firmware. The decision, whether to use the latest firmware with the latest feature set or to keep the current firmware with the current feature set can be made for each project and independent of the installed Automation Builder version.

Speeding up during commissioning and maintenance

Whenever there is an issue in the automation system, it is required to quickly and efficiently fix it. Automation Builder supports this by a generic three-step approach:

- General diagnosis provides a traffic light view on devices and (sub)systems.
- Detailed diagnosis provides detailed information e.g. about the source and the type of the issue.
- Extended diagnosis is available for some subsystems such as fieldbuses and offers advanced commissioning functions such as comparing connected vs. configured devices or manual control of bus states.

The diagnosis information is accessible not only via Automation Builder, but also via the AC500 display, the PLC application or operator panels.

Easily create a connected world

Connectivity can be achieved in multiple ways. Different cloud protocols like MQTT or OPC UA are deeply integrated into ABB AC500 PLCs. For advanced connectivity needs the integration with CP600 operator panels or even with the ABB zenon software can be used for further processing and transmission of any data. Setting up the interfaces and sharing the data is not much more than a single click in Automation Builder.

Advanced simulation – a game changer in engineering

Simulate all kinds of applications with minimum effort. Test the complete system seamlessly before involving real hardware. Even complex systems can be built up efficiently, ensuring smooth interaction of all components and operator training at an early stage.

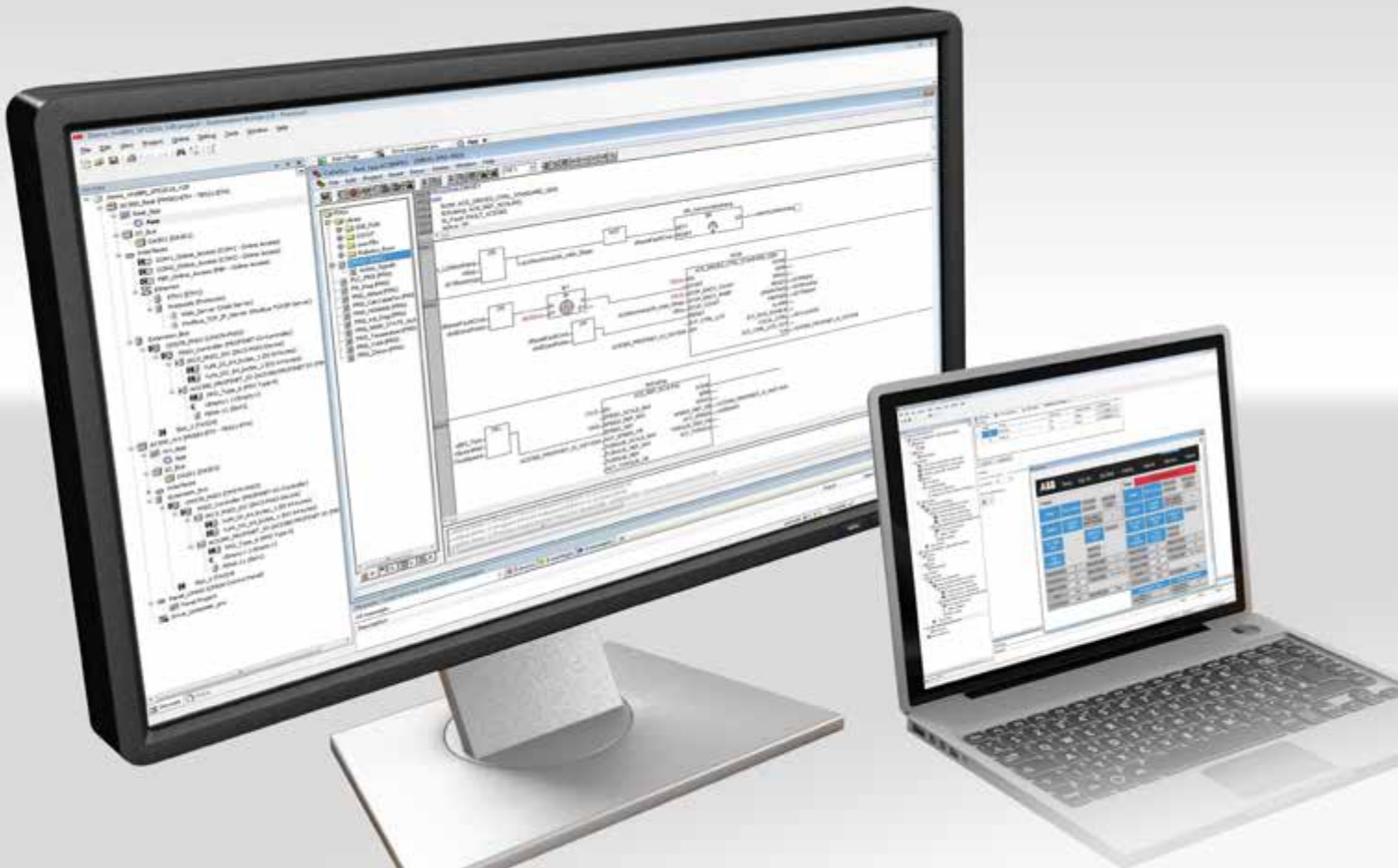

Download Automation Builder from

new.abb.com/automationbuilder

Familiarize yourself with Automation Builder using the 30-day test license.

PLC Automation product family

AC500 libraries and software

A good investment for system integrators and end-users, AC500 libraries and software improve stability while reducing warranty costs and service. Library and software packages contain functions or protocols and easy-to-use examples for minimal programming effort and quick implementation of complex and demanding applications.

AC500 libraries and software deliver the seamless integration of PLCs, drives and HMI required to build and commission automation solutions quickly and easily. AC500 libraries and software by ABB are maintained to ensure that your programs can also be used with less risk.

Solar library

Library package for solar trackers increasing energy efficiency, providing quick commissioning and excellent positioning accuracy.

Water library

Library package with energy efficiency functionalities offering quick commissioning of water applications, such as pump stations with remote communication.

Temperature control library

Library package for the advanced PID temperature control of demanding applications, for example extrusion.

HA-CS31 library

Library package adds high availability system functionality for redundant hot standby over serial CS-31 bus.

Drive integration library

Library package for the quick integration of ABB ACS drives using different fieldbuses.

Motion control library

Library package with axis wizard and CAM editor for decentral, central and coordinated motion according to the PLCopen standard.



BACnet library

Library package adds BACnet-ASC device profile for communication to BMS Building Management Systems in larger infrastructure projects.

HA-Modbus TCP library

Library package adds High Availability System functionality for redundant hot standby over Ethernet field network via Modbus TCP.

KNX protocol

Engineering and protocol package which seamlessly integrates ETS and Automation Builder.

61850 protocol

Adds engineering tool and library for 61850 Ed.1 MMS Server and GOOSE publish and subscribe functionalities.

PCO library

Contains process control function blocks for integration of AC500 as controller in a DCS solution. For ABB Ability™ System 800xA an object library is available which provides matching symbols and faceplates.



PLC Automation product family

PLCs at a glance ...

AC500 Programmable Logic Controllers with scalable, state-of-the-art technology for better performance.

Standard industrial communication fieldbus, network and protocols supported by the 'One Platform' solution make the AC500 the perfect automation solution in even the most demanding

environments. Flexible and scalable superior CPUs deliver performance whenever and wherever you need it.



Secure cloud connectivity options



One programming tool for the entire AC500 PLC platform



Scalable and flexible range of products, with various communication protocol and connectivity options



Reliable, secure and safe with different performance levels



The ideal choice for high availability, extreme environments, condition monitoring, motion control or safety solutions

AC500 PLC platform

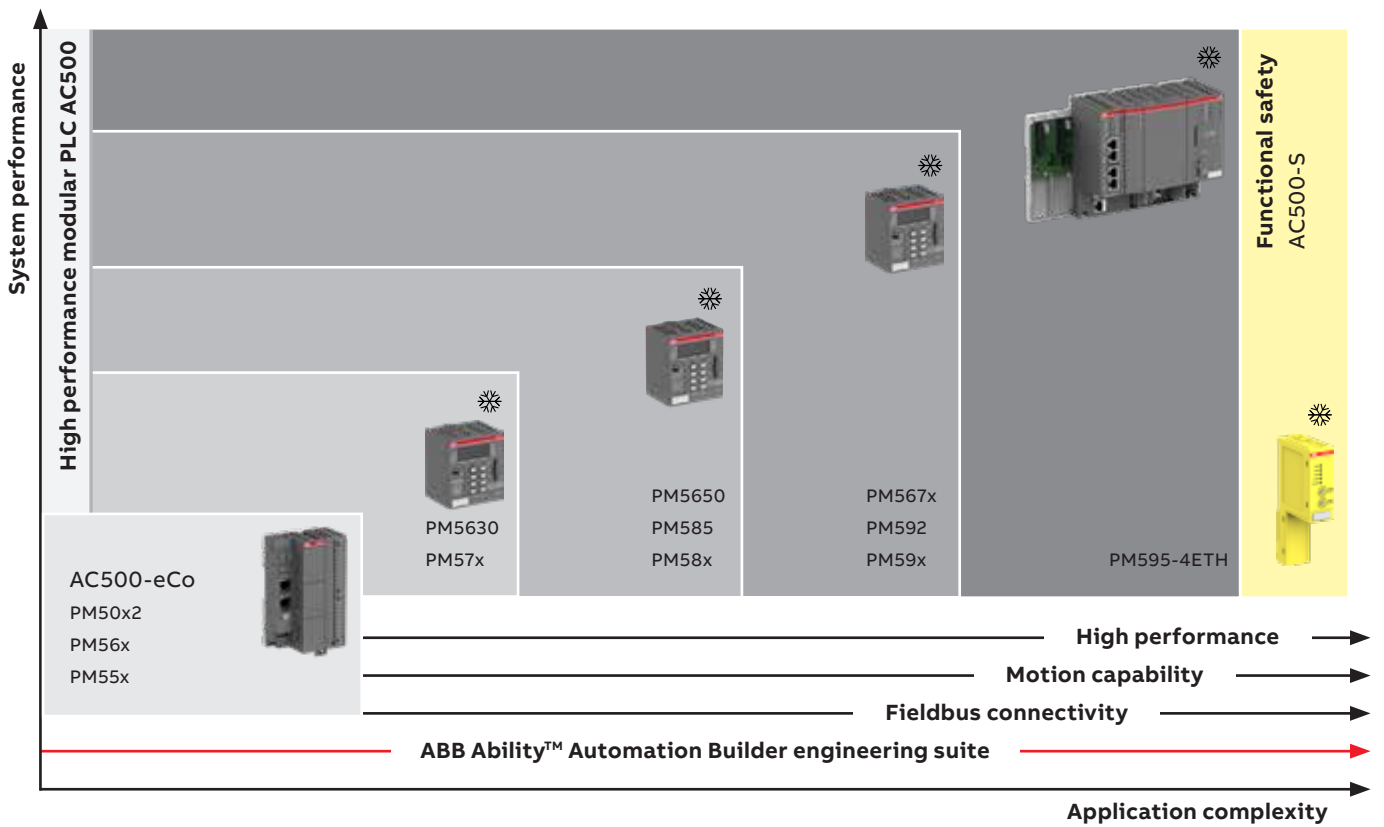

PLC Automation product family

PLCs at a glance ...

	AC500-eCo V3	AC500	AC500 V3
System configuration and application programming			
Automation Builder (common programming tool)	●	●	●
Application Features			
Extended temperature range	● Pro W version (5)		
Extreme conditions in harsh environments			
Functional safety		●	●
Support of simple motion with FM562 module (1)		●	
Support of simple motion with onboard I/O PTO/PWM	●		
Support of PLCopen Motion Control	● (3) not Basic version	●	● (3)
Support of High Availability (HA) CS31 based		●	
Support of High Availability (HA) Modbus TCP based		● (4)	● (4)
Hot Swap of attached I/Os mounted on Hot Swap terminal unit		● (9)	●
CPU features			
	AC500-eCo V3	AC500	AC500 V3
Performance (time per binary instruction)	0.20...0.02 μs	0.0006...0.06 μs	0.001...0.02 μs
Program memory	1 ... 8 MB (8) thereof	128 kB...16 MB	8 ... 160 MB (8) thereof
User data memory	Prog. code + Data (12) 256 kB... 1 MB	128 kB...16 MB	Prog. code + Data (12) 2 MB ... 32 MB
Remanent data (= saved)	8... 100 kB	12 kB...3 MB	256 kB ... 1.5 MB
Serial communication			
RS232	● with option board	●	●
RS485	● with option board	●	●
Isolated interface	● with option board	●	●
Modbus RTU Master/Slave	● with option board	●	●
CS31 protocol		●	
CAN communication interface on CPU			
CANopen Master, J1939 and CAN 2A/2B protocols			●
Ethernet features on CPU with integrated Ethernet or external communication module			
Online access (Programming)	● only onboard	●	●
ICMP (Ping), DHCP, IP configuration protocol	● only onboard	●	●
UDP data exchange, Modbus TCP	● only onboard	●	●
Ethernet features on CPU with integrated Ethernet only			also on CM5640-2ETH communication module
HTTP / HTTPS (integrated web server)	● / ● not Basic version	● / -	● / ●
HTML 5 Web Visu	● / ● not Basic version		●
Sntp (AC500 V2), NTP (AC500 V3, AC500-eCo V3) (Time synchronization) Client / Server	● / ●	● / ●	● / ●
FTP / FTPS server	● / ●	● / -	● / ●
FTP client		● (7)	
SMTP client (Simple Mail Transfer Protocol)	● (5)	●	● (5)
IEC 60870-5-104 remote control protocol	● Pro version	●	●
MQTT for IoT connection with TLS security	● not Basic version	●	●
Network variables on UDP	●		●
Socket programming	●	●	●
OPC DA (AC500 V2 and V3)	●	●	●
OPC UA server (AC500 V3 only)	● not Basic version		●
Selectable protocol			
BACnet (B-ASC profile)		● (4)	
BACnet (B-BC profile)	● (4) Pro version		● (4)
KNX protocol for building communication	● (4) Pro version		● (4)
IEC 61850 protocol (MMS Server, GOOSE)	● (4) Pro version		● (4)
EtherCAT Master	● (4) (5) (11)	● (6)	
PROFINET IO Controller		● (6)	
Ethernet/IP Scanner / Adapter	● (4) (5) not Basic version		● (4)(5) only adapter on CM5640-2ETH
Capability to connect fieldbus modules	○ Modbus TCP	●	●
I/Os integrated on CPU	● with motion I/Os		
I/O modules features			
	S500-eCo	S500	S500
Analog modules			
Configurable		●	●
Dedicated	●		
Digital modules			
Configurable	○	●	●
Dedicated	●	●	●
Transistor outputs short circuit protected		●	●
Output diagnosis		●	●
Hot Swap of I/O modules (10)		●	●
Extension with S500-eCo and S500(-XC) I/O modules	●	●	●

AC500-S (2)	AC500-XC	AC500-XC V3	AC500-S-XC (2)
●	●	●	●
	●	●	●
	●	●	●
●	●	●	●
●	●	●	●
●	●	● (3)	●
	●		
	● (4)	● (4)	
	● (9)	●	
AC500-S (2)	AC500-XC	AC500-XC V3	AC500-S-XC (2)
0.05 μs	0.0006...0.06 μs	0.001...0.02 μs	0.05 μs
1...1.3 MB	128 kB...16 MB	8 ... 160 MB (8) thereof	1...1.3 MB
1024 kB	128 kB...16 MB	Prog. code + Data (12) 2 MB ... 32 MB	1024 kB
120 kB	12 kB...3 MB	256 kB...1.5 MB	120 kB
●	●	●	●
●	●	●	●
●	●	●	●
●	●	●	●
●	●	●	●
		●	
●	●	●	●
●	●	●	●
●	●	●	●
		also on CM5640-2ETH-XC communication module	
● / -	● / -	● / ●	● / -
● / ●	● / ●	● / ●	● / ●
● / -	● / -	● / ●	● / -
● (7)	● (7)	● (5) for V3	● (7)
●	● (5) for V3	● (5) for V3	●
●	●	●	●
●	●	●	●
●	●	●	●
		●	
● (4)	● (4)	● (4)	● (4)
		● (4)	
		● (4)	
	● (6)		
	● (6)		
		● (4)(5) only adapter on CM5640-2ETH-XC	
●	●	●	●
S500-S (2)	S500-XC	S500-XC	S500-S-XC (2)
●	●	●	●
	●	●	
●	●	●	●
●	●	●	●
●	●	●	●
● (2)	●	●	● (2)

- fully
- partly
- (1) Requires Library PS552-MC-E
- (2) AC500-S and AC500-S-XC require AC500 or AC500-XC modules to operate. The latter supports all communication interfaces.
- (3) Requires new V3 Library PS5611-MC
- (4) Licensed features, runtime license per CPU.
- (5) In preparation
- (6) PM595 and/or CPU V3 only
- (7) Application library download from "application examples"
- (8) Memory size is complete size for program, data and web server with AC500 V3 CPU, thereof size of User data and User program is smaller
- (9) As of PM585-ETH
- (10) Mounted on Hot Swap terminal unit when attached to AC500 CPU V2 as of PM585-ETH or AC500 CPU V3 or communication interface modules for Modbus TCP, PROFINET (CI501-PNIO, CI502-PNIO) or PROFIBUS.
- (11) Only Pro PM5072 version
- (12) Memory size of V2 versus V3 CPUs is not comparable. Projects have a different and separate User Program code and Data memory calculation in Automation Builder 2.4.0 version or later: System, configuration and web server parts are not counted anymore. This results in typically about 50% lower memory usage compared to V2, and even lower memory usage compared to V3 projects compiled in Automation Builder 2.3.0 or before.

PLC Automation product family

AC500 V2 CPU Selector

Your requirements

You are looking for a well established PLC solution with large product range for all kind of applications. You need particularly:

- Support of CS31 serial interface communication and High Availability solution with fast switching time
- Condition Monitoring capability
- Support of various types of communication protocols like PROFIBUS DP, CANopen, PROFINET, EtherCAT or serial interface protocols
- IoT connection with MQTT support
- Safety applications with support of PROFI-safe communication (F-Host and F-Device)
- PLC integration into System 800xA DCS communication

Application specification and performance needs

Small application

- less-complex communication via standard industrial fieldbus
- simple safety solution

	AC500
	PM57x
Basic	
What does your project need?	
Compactness and onboard I/Os ?	●
230 V AC power supply onboard ?	○
Standard operational temperature ?	●
Extreme environmental conditions (e.g. high temperature, humidity or vibrations) ?	● (XC)
Functional Safety up to SIL3 ?	●
Application feature	
Simple motion with PTO module FM562 / onboard I/O ?	● / -
High-speed motion or interpolated motion ?	-
Data logging ?	-
Condition monitoring CMS ?	-
High availability with CS31 protocol ?	○
High availability with Ethernet Modbus TCP protocol ?	○
HTML5 web server ?	-
Telecontrol with IEC 60870-5-104 ?	○
Process control objects library (PCO) for DCS integration ?	●
Application performance	
More than 1 Cyclic and 1 Interrupt IEC 61131 Task ?	●
4 or more IEC 61131 Tasks ?	-
More than 2 kB retain variables ?	●
User program / User data memory ?	512 kB / 512 kB
Large flash disk for data collecting ?	-
Web server data ≤ 1MB ?	●
Web server data ≥ 4MB ?	-
Floating point arithmetic calculation with FPU ?	-
Number of Ethernet Sockets for parallel connection ?	≤ 13
Number of Modbus TCP Sockets (part of Ethernet Sockets) ?	≤ 12
CPU performance (ns per bit instruction) ?	60 ns
Communication/Fieldbus	
Decentralized I/Os or communication on serial CS31 fieldbus ?	●
Decentralized I/Os or communication on serial Modbus RTU fieldbus ?	●
Decentralized I/Os or communication on PROFIBUS DP master / slave fieldbus ?	● / ●
Decentralized I/Os or communication on CAN/CANopen master / slave fieldbus ?	● / ●
Decentralized I/Os or communication on Modbus TCP network ?	●
Decentralized I/Os or communication on PROFINET IO controller / device network ?	● / ●
Decentralized I/Os or communication on EtherCAT master network ?	●
Two or more onboard Ethernet interfaces ?	-
Onboard selectable protocols PROFINET IO / EtherCAT ?	-
KNX building communication	-
BACnet (B-ASC profile) / BACnet (B-C profile)	● / -
IEC 61850 MMS / GOOSE protocol ?	-
IoT enabled with MQTT with TLS secured communication, support of JSON library	●
OPC UA server ?	-

- Not possible

○ Possible but not optimal solution

● Possible with additional devices

● Possible and best selection

Small application

- less-complex communication via standard industrial fieldbus
- simple safety solution

Medium to large application

- good motion capability
- medium to complex communication via standard industrial fieldbus and Ethernet-based protocols
- safety applications with F-Device support

Large demanding application

- with fast response time for motion, calculation or complex communication via standard industrial fieldbus and Ethernet-based protocols
- complex safety calculation with F-Device support and/or CMS

Extremely demanding application

- complex communication with embedded Ethernet-based coupler and fast response time
- highly-complex safety support with F-Device
- high speed and/or extensive coordinated motion control

PM58x	PM585-ETH	PM59x-ETH	PM591-2ETH	PM592-ETH	PM595-4ETH
○	○	○	○	○	○
○	○	○	○	○	○
●	●	●	●	●	●
● (XC)	-	● (XC)	● (XC)	● (XC)	● (XC)
●	●	●	●	●	●
● / -	● / -	● / -	● / -	● / -	● / -
-	●	●	●	●	●
○	○	●	●	●	●
-	-	-	-	●	-
●	●	●	●	●	●
○	●	●	●	●	●
-	-	-	-	-	-
○	○	●	●	●	●
●	●	●	●	●	●
●	●	●	●	●	●
○	●	●	●	●	●
●	●	●	●	●	●
1 MB / 1 MB	1 MB / 2 MB	2-4 MB / 2-4MB	4 MB / 4 MB	4 MB / 4 MB	16 MB / 16 MB
○	○	○	○	4 GB	4 GB
○	○	○	○	○	○
4 MB	4 MB	8 MB	8 MB	8 MB	16 MB
-	●	●	●	●	●
≤ 22	≤ 29	≤ 29	≤ 61	≤ 29	≤ 61
≤ 12	≤ 12	≤ 12	≤ 28	≤ 12	≤ 28
50 ns	4 ns	2 ns	2 ns	2 ns	0.6 ns
●	●	●	●	●	●
●	●	●	●	●	●
● / ●	● / ●	● / ●	● / ●	● / ●	● / ●
● / ●	● / ●	● / ●	● / ●	● / ●	● / ●
●	●	●	●	●	●
● / ●	● / ●	● / ●	● / ●	● / ●	● / ●
●	●	●	●	●	●
-	-	-	●	-	●
-	-	-	-	-	● / ● / -
-	-	-	-	-	-
● / -	● / -	● / -	● / -	● / -	● / -
-	-	-	-	-	-
●	●	●	●	●	●
-	-	-	-	-	-

Automation product family

AC500 V3 CPU Selector

Your requirements

You are looking for a well established PLC solution with a large product range for extended features and large communication capability. You need particularly:

- Large memory and computing performance for your application
- High Ethernet capability with secured communication and support of communication network with extensive Modbus TCP communication
- IoT connection with MQTT support and OPC UA server
- Very efficient web visualization with HTML5 support
- Safety applications with local or decentralized I/O on PROFINET/PROFIsafe
- Fast coordinated motion capability from small to large CPU with embedded motion I/O or EtherCAT support

Application specification and performance needs

- | | |
|---|---|
| <p>Extremely cost-sensitive simple application</p> <ul style="list-style-type: none"> • with compact PLC and a small number of I/Os | <p>Cost-effective small application</p> <ul style="list-style-type: none"> • with compact PLC and large number of onboard I/Os • effective modularity with option boards • less-complex communication on Ethernet-based industrial fieldbus • IoT enabled with MQTT and OPC UA • web server applications • simple motion capability with high-speed onboard I/Os |
|---|---|

		A500-eCo V3		
		Basic	Standard	
		PM5012-x-ETH	PM5032-x-ETH	PM5052-xETH
Basic	What does your project need?			
	Compactness and onboard I/Os ?	●	●	●
	230 V AC power supply onboard ?	○	○	○
	Standard operational temperature ?	●	●	●
Application feature	Extreme environmental conditions (e.g. high temperature, humidity or vibrations) ?	-	-	-
	Functional Safety up to SIL3 ?	○	○	○
	Simple motion with PTO on onboard I/O ?	○	●	●
	High-speed motion or interpolated motion ?	-	-	-
	Data logging ?	-	-	-
	Condition monitoring CMS ?	-	-	-
	High availability with Ethernet Modbus TCP protocol ?	-	-	-
	HTML5 web server ?	-	●	●
	Process control objects library (PCO) for DCS integration ? (6)	●	●	●
	Application performance	More than 1 Cyclic and 1 Interrupt IEC 61131 Task ?	○	●
4 or more IEC 61131 Tasks ?		-	●	●
More than 2 kB retain variables ?		●	●	●
Total user program memory / thereof user program code + data max.		1 MB / 256 kB (5)	2 MB / 512 kB (5)	4 MB / 768 kB (5)
Large flash disk for data collecting ?		-	-	○
Web server data ≤ 1MB ?		-	-	-
Web server data ≥ 4MB ?		-	see above (2)	see above (2)
Floating point arithmetic calculation with FPU ?		-	●	●
Number of Ethernet Sockets for parallel connection ?		Unlimited (3)	Unlimited (3)	Unlimited (3)
Number of Modbus TCP Sockets (part of Ethernet Sockets) ?		8	20	20
Communication/Fieldbus	CPU performance (ns per bit instruction) ?	20 ns	20 ns	20 ns
	Motion performance PTO axis / ms	-	4 / 5	4 / 2
	Motion performance EtherCAT axis / ms	-	-	-
	Decentralized I/Os or communication on serial CS31 fieldbus ?	-	-	-
	Decentralized I/Os or communication on serial Modbus RTU fieldbus ?	●	●	●
	Decentralized I/Os or communication on PROFIBUS DP master / slave fieldbus ?	-	-	-
	Decentralized I/Os or communication on CAN/CANopen master / slave fieldbus ?	-	-	-
	Decentralized I/Os or communication on Modbus TCP network ?	●	●	●
	Decentralized I/Os or communication on PROFINET IO controller / device network ?	-	-	-
	Decentralized I/Os or communication on EtherCAT master network ?	-	-	-
Communication/Fieldbus	Two or more onboard Ethernet interfaces ?	-	-	-
	Telecontrol with IEC 60870-5-104 ?	-	-	-
	Onboard selectable protocols Ethernet/IP ?	-	● (4)	● (4)
	KNX building communication	-	-	-
	BACnet (B-ASC profile) / BACnet (B-C profile)	-	-	-
	DNP3	-	-	-
	IEC 61850 MMS / GOOSE protocol ?	-	-	-
	IoT enabled with MQTT with TLS secured communication, support of JSON library	-	●	●
	OPC UA server ?	-	●	●

- Not possible

○ Possible but not optimal solution

● Possible with additional devices

● Possible and best selection

Small application

- large program/data memory
- medium-complex communication via Ethernet-based industrial fieldbus
- IoT capability with MQTT and OPC UA
- building control applications with KNX
- simple or coordinated motion

Small application

- large program/data/web memory
- good capability for communication via standard industrial fieldbus and Ethernet-based protocols
- simple safety application local or decentralized on PROFI-safe
- coordinated motion capability on EtherCAT or CAN onboard

Medium to large application

- very large program/data and web server memory
- good coordinated motion capability on EtherCAT or onboard CAN
- medium to complex communication via industrial fieldbus and Ethernet-based protocols
- medium safety applications with PROFI-safe

Extremely demanding application

- with fast response time and complex communication with industrial fieldbus and Ethernet-based protocols
- highly-complex OPC UA communication and MQTT
- larger web server applications
- very large High Availability application with complex Modbus TCP communication
- highly-complex safety applications with PROFI-safe
- high speed and/or large coordinated motion control
- very large flash disk for data collection

	AC500 V3				
Pro					
PM5072-x-2ETH(W)	PM5630 V3	PM5650 V3	PM5670 V3	PM5675 V3	
●	○	○	○	○	○
○	○	○	○	○	○
●	●	●	●	●	●
○ (W version)	● (XC)	● (XC)	● (XC)	● (XC)	● (XC)
○	●	●	●	●	●
●	-	-	-	-	-
● (4)	● (4)	● (4)	● (4)	● (4)	● (4)
○	○	●	●	●	●
-	-	-	-	-	-
-	●	●	●	●	●
●	●	●	●	●	●
●	●	●	●	●	●
●	○	●	●	●	●
●	●	●	●	●	●
8 MB / 1 MB (5)	8 MB / 2 MB (5)	80 MB / 8 MB (5)	160 MB / 32 MB (5)	160 MB / 32 MB (5)	
○	○	○	○	8GB	
-	○	○	○	○	
see above (2)	see above (2)	see above (2)	see above (2)	see above (2)	
●	●	●	●	●	
Unlimited (3)	Unlimited (3)	Unlimited (3)	Unlimited (3)	Unlimited (3)	
30	30	50	120	120	
20 ns	20 ns	10 ns	2 ns	2 ns	
4 / 1	-	-	-	-	
-	4 / 2	8 / 1	16 / 1	16 / 1	
-	-	-	-	-	
●	●	●	●	●	
-	● / ●	● / ●	● / ●	● / ●	
-	● / -	● / -	● / -	● / -	
●	●	●	●	●	
-	● / ●	● / ●	● / ●	● / ●	
○ (1)(4)	●	●	●	●	
●	●	●	●	●	
●	●	●	●	●	
● (4)	● (4)	● (4)	● (4)	● (4)	
● (4)	● (4)	● (4)	● (4)	● (4)	
- / ● (4)	- / ● (4)	- / ● (4)	- / ● (4)	- / ● (4)	
● (1)(4)	● (1)(4)	● (1)(4)	● (1)(4)	● (1)(4)	
● (4)	● (4)	● (4)	● (4)	● (4)	
●	●	●	●	●	
●	●	●	●	●	

(1) In preparation
 (2) Total memory for code, data and web server with AC500 V3 CPU, thereof size of User data and User program is smaller and dynamically allocated
 (3) Number of ETH Socket total is basically not limited, but depends on: CPU load, priority of application tasks, kind of used protocols, amount of data transferred, network structure
 (4) Feature(s) is (are) licensed, runtime license per CPU.
 (5) Memory size of V2 versus V3 CPUs is not comparable. Projects have a different and separate User Program code and Data memory calculation in Automation Builder 2.4.0 version or later. System, configuration and web server parts are not counted anymore. This results in typically about 50% lower memory usage compared to V2, and even lower memory usage compared to V3 projects compiled in Automation Builder 2.3.0 or before.
 (6) Available as application example with compiled library.

PLC Automation product family

AC500-eCo – modular concept

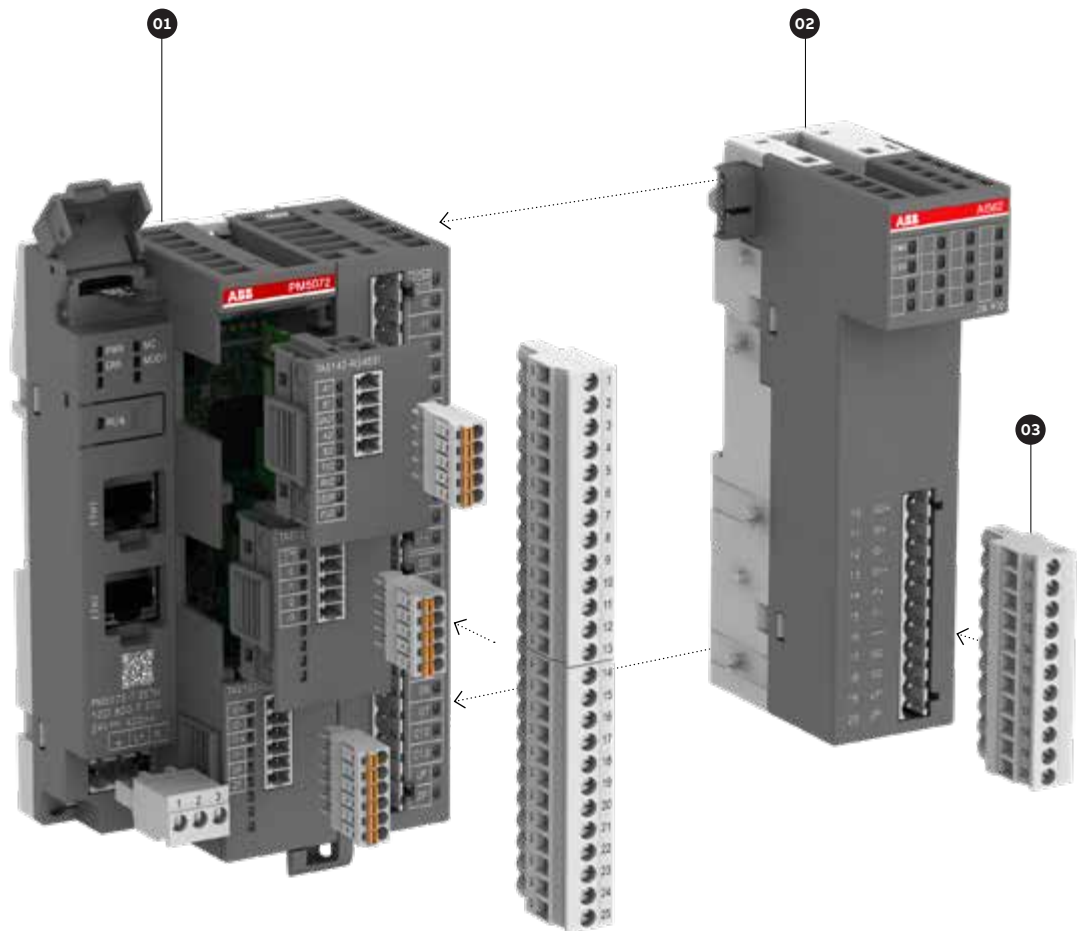

01 – AC500-eCo central processing unit (CPU)

- Different memory options
- Different CPU types and performances
- Integrated communication option
- Onboard I/O extension using option board slots of AC500-eCo V3 CPU
- Ethernet-based communication.

02 – S500-eCo I/O modules

- Up to 10 modules
- Decentralized extension available.

03 – Terminal blocks

- Three types of pluggable terminal blocks available for AC500-eCo V2 and S500-eCo I/O modules
- Two types of terminal block sets for AC500-eCo V3.

PLC Automation product family

AC500 and AC500-XC – modular concept

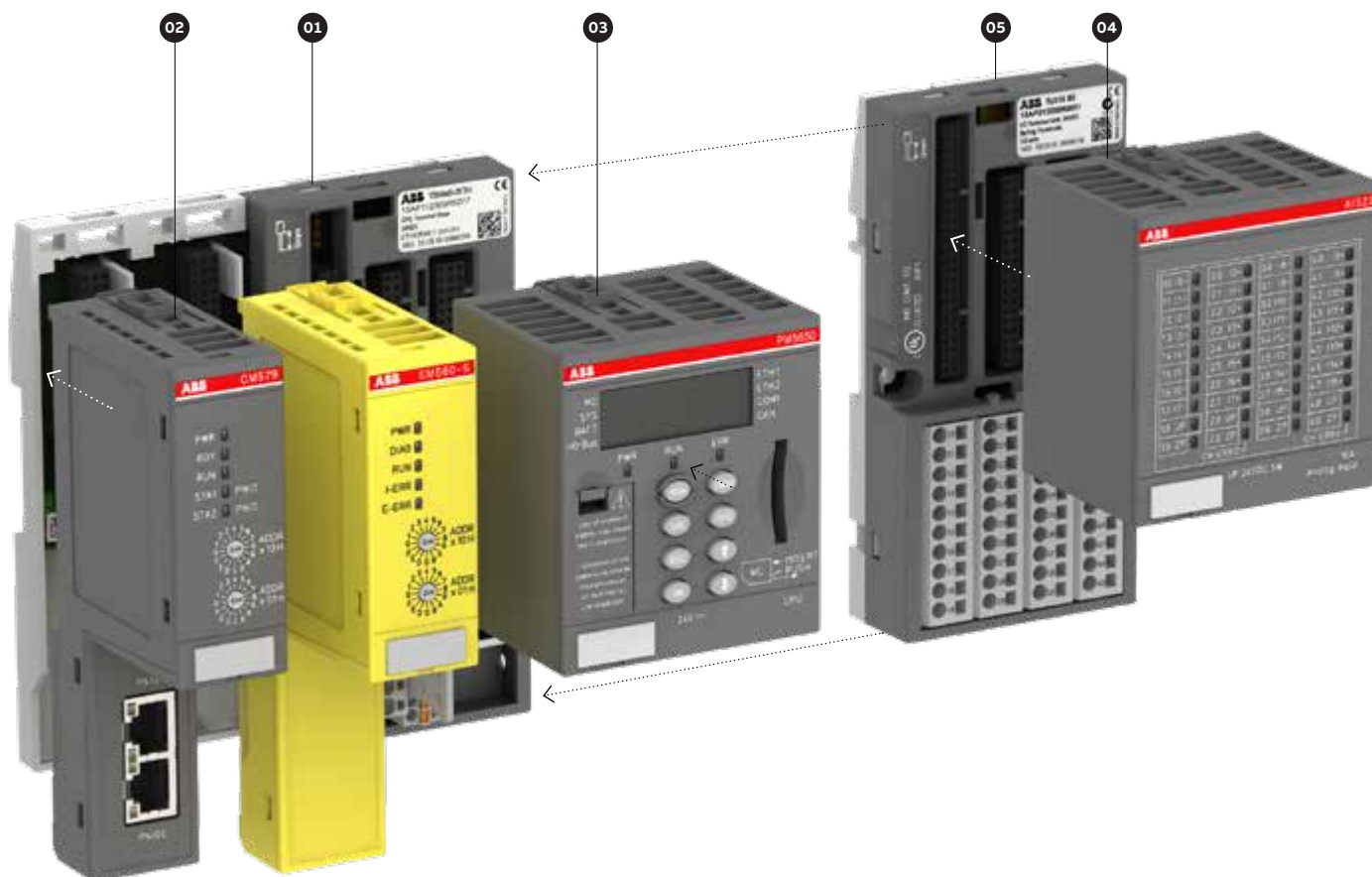

01 – Terminal base

- Common for all AC500 V2 CPU types
- For 1, 2 or 4 communication modules
- With serial interfaces
- With 1 or 2 Ethernet interfaces
- Specific terminal base only for AC500 V3 CPU with 0, 1, 2, 4 and 6 communication modules.

02 – Communication modules

- For PROFIBUS DP, Ethernet, Modbus TCP, EtherCAT, CANopen, PROFINET IO or serial programmable
- Up to 4 pluggable
- Up to 6 pluggable for AC500 V3 CPU
- Support of AC500-S safety solution.

03 – AC500 central processing unit (CPU)

- Different performance, memory, network, operating conditions options
- Integrated communication
- AC500 V3 CPU with large memory and high performance (requires specific terminal base).

04 – S500 I/O modules

- Up to 10 modules
- Decentralized extension available
- Hot Swap I/Os local or decentralized on PROFINET IO and additionally PROFIBUS DP for V2.

05 – Terminal units

- Up to 10 terminal units
- Decentralized extension available.

PLC Automation product family

S500 I/O system – modular concept

The S500 I/O module range, which is part of the AC500 PLC platform, can be used with the AC500 PLCs and other controllers. Whether for standard situations or extreme conditions: With these I/O modules you will have a cost-efficient solution with low technical barriers in many industry segments, especially in water & wastewater, food & beverage, paper or data centers. In addition to saving time and money you will benefit from more...

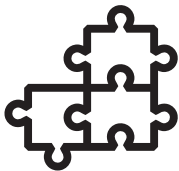

Easiness

- Fast integration into existing environment
- Easy integration with third-party PLCs
- Lean portfolio covers all requirements
- I/O modules with configurable channels allow for less inventory

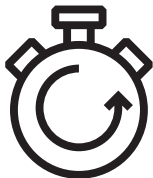

Efficiency

- Configurable I/Os reduce footprint & price
- Hot-Swap I/Os for increased availability
- Fast counters on each module
- Pre-wiring possible
- Scalable assortment optimizes price

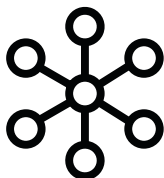

Flexibility

- Terminal units which fit many different I/O modules
- Openness with support of different fieldbus protocols
- S500-eCo and standard S500 I/O modules can be mixed
- Configurable channels make subsequent configuration change possible

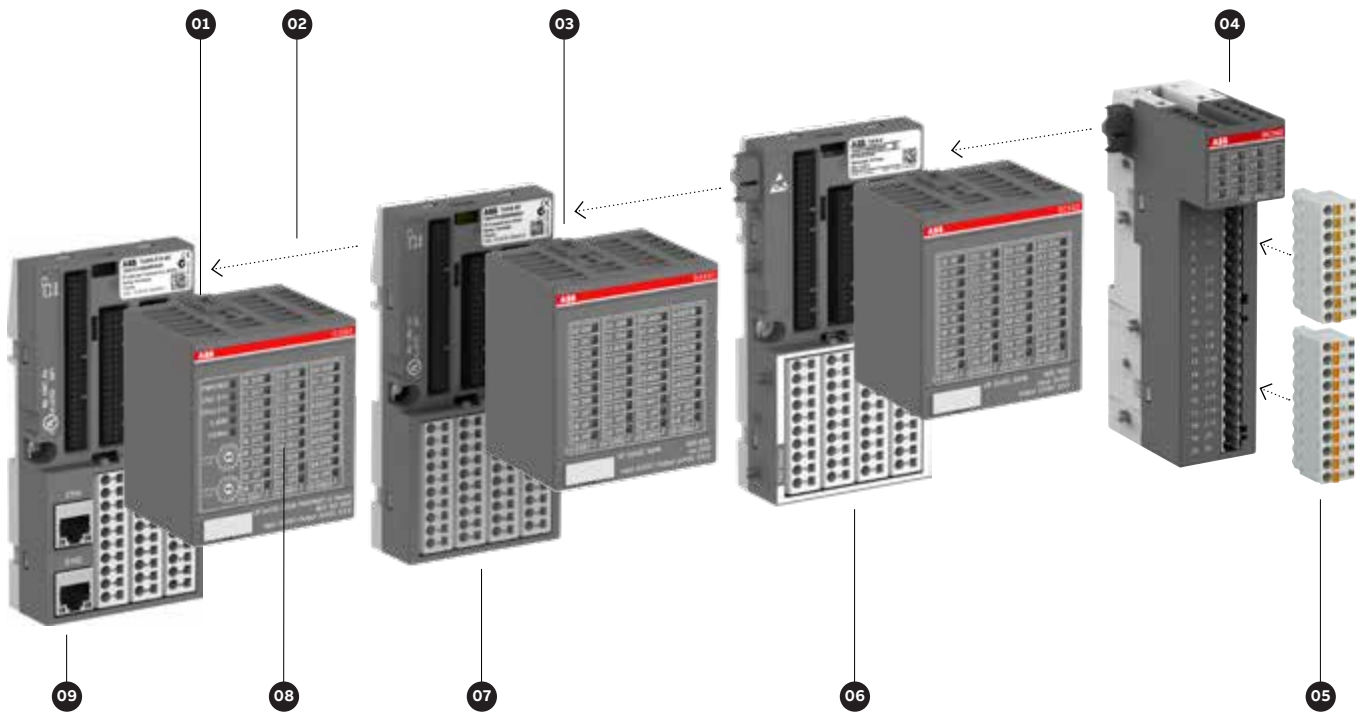

01 – Communication interface modules

Available for common fieldbuses:

- PROFIBUS-DP
- PROFINET
- EtherCAT
- Modbus TCP
- CANopen

02 – I/O bus

Transmits process data between communication interface module and I/O modules

03 – S500 I/O modules

With up to 32 channels in variants for analog and digital signals

04 – Compact S500-eCo I/O modules

With up to 16 channels in variants for analog and digital signals

05 – Removable terminal blocks

Push-in spring or screw connectors for cables up to 2.5 mm²

06 – Terminal units for Hot Swap of I/Os

For exchange of I/O modules while the system is running

07 – Terminal units for I/Os

Variants with screw or spring connection

08 – Integrated I/Os

Up to 24 I/O channels in the communication interface module save space

09 – Terminal units for communication interface modules

Variants for different fieldbus types

PLC Automation product family

AC500-eCo V3 system characteristics

The AC500-eCo V3 Basic, Standard and Pro CPUs are available with different performance levels. For digital and analog I/O or communication extension, option boards can be used. Locally, AC500-eCo V3 Standard and Pro CPUs can be extended with up to 10 I/O modules.

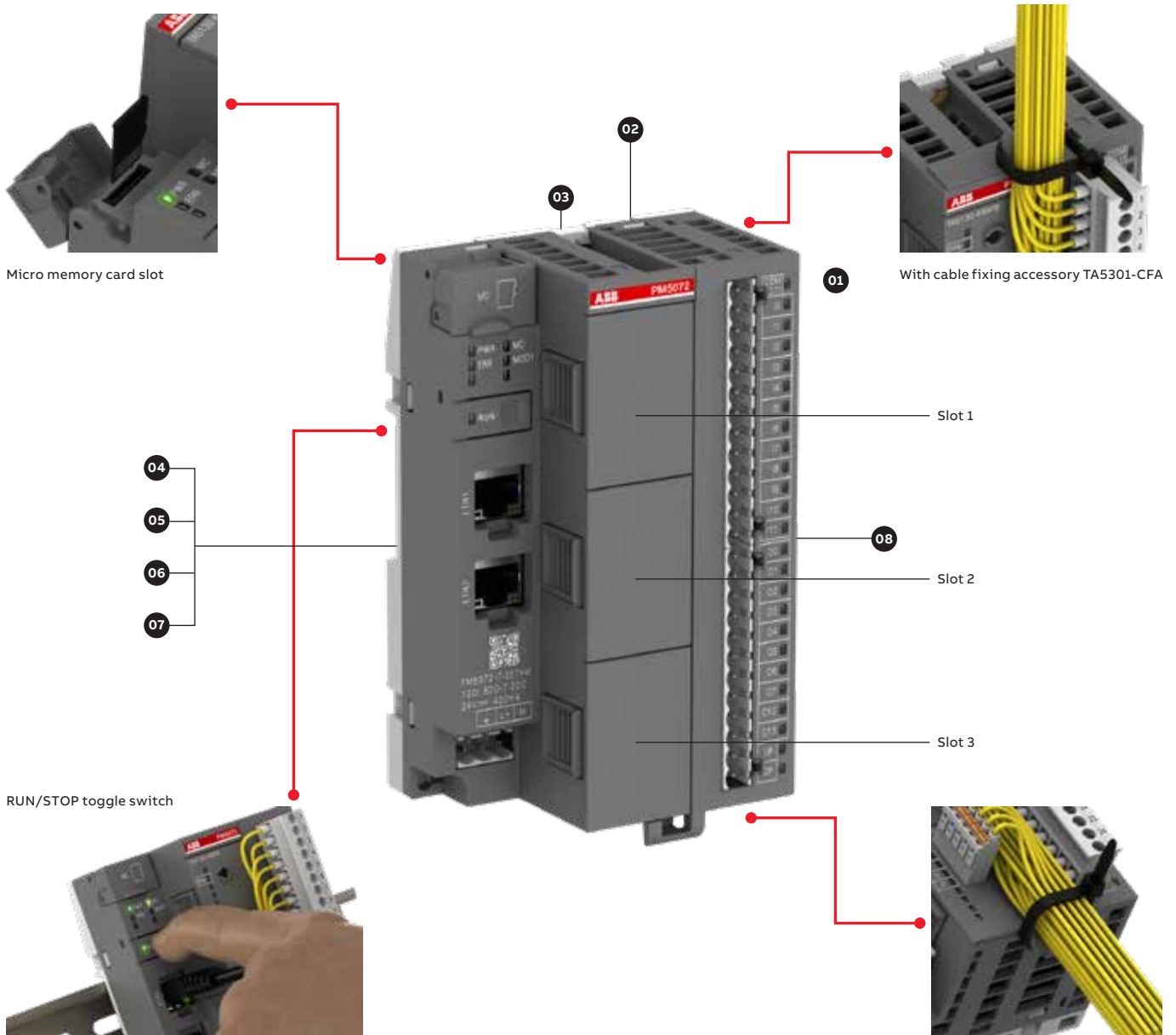

	Basic	Standard	Pro
	PM5012-x-ETH	PM5032-x-ETH	PM5052-x-ETH
Option board slot 1	●	●	●
Option board slot 2	-	●	●
Option board slot 3	-	-	●

— 01 AC500-eCo V3 Standard and Pro CPUs are locally extendable with up to 10 I/O modules (standard S500 and S500-eCo I/O modules can be mixed).

— 02 Cable fixing adapter

— 03 Wall mounting

— 04 Option boards for digital I/O extension

— 05 Option boards for analog I/O extension - in preparation

— 06 Option boards for COMx serial communication

— 07 Option boards KNX address push button or slot cover

— 08 Terminal block sets

— 09 AC500-eCo Starter kit. For more information, see page 271

— 10 Input simulator

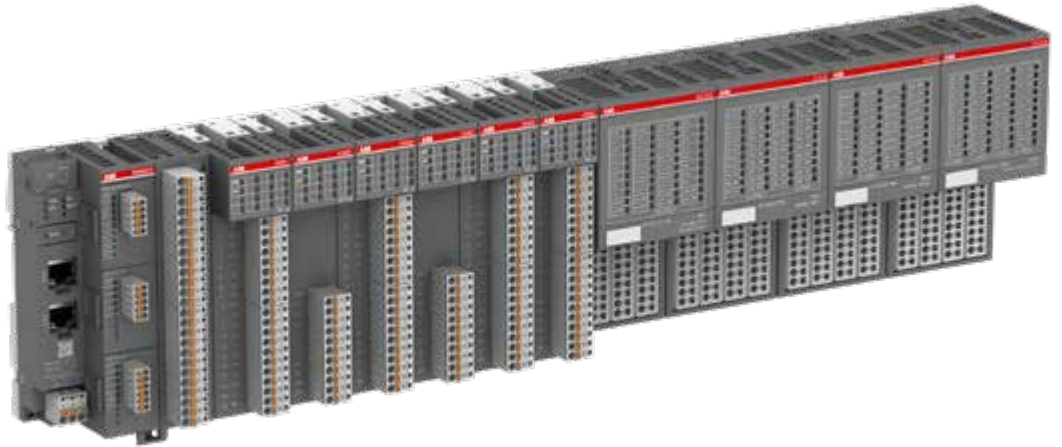

— 01



— 02



— 03



— 04



— 05



— 06



— 07

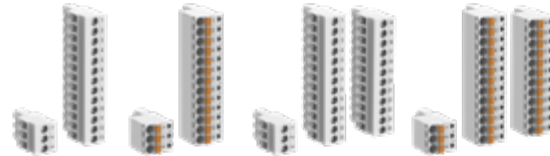

— 08



— 09



— 10







Please discover our [AC500-eCo V3 brochure](#)

PLC Automation product family

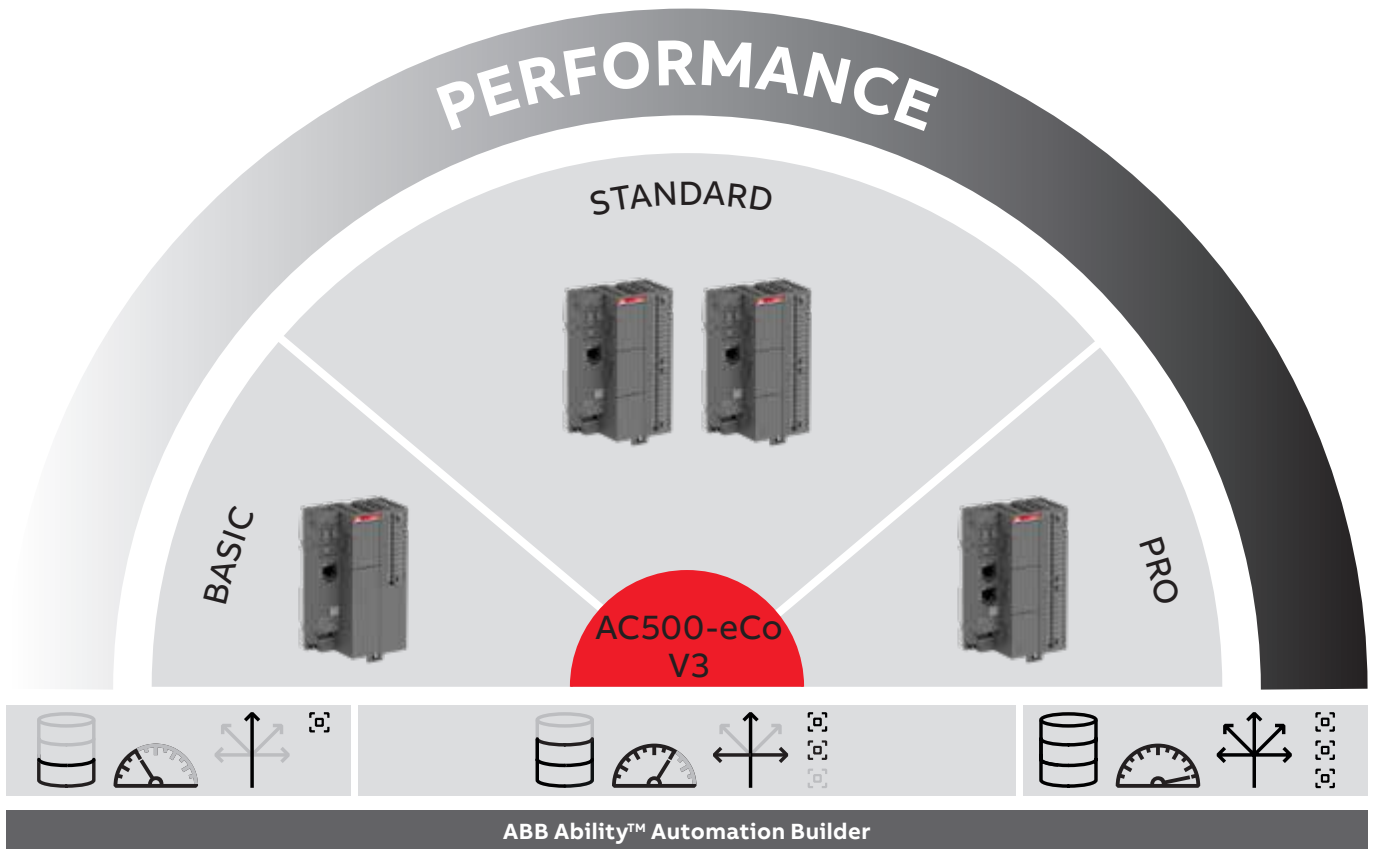
AC500-eCo V3 overview

More AC500-eCo features but the same footprint



-  Memory
-  Performance
-  Connectivity
-  Option board

BASIC**STANDARD****PRO****Basic****Basic and compact applications**

- For extremely cost-sensitive and simple applications
- Few I/O channels only
- Ethernet communication
- Easy onboard extension with one option board, no I/O-bus
- Adequate performance
- Benefits from the ABB Ability™ Automation Builder software platform

Standard**For modular and distributed applications**

- Powerful processor with integrated Floating Point Unit for fast calculation
- Ethernet interface on all the products for all-purpose communication (e.g. Modbus TCP, Ethernet/IP (1))
- Web server with HTML5 web visualization
- IoT-enabled with OPC UA server
- MQTT protocol
- High modularity with up to 3 option boards for I/O extension and communication
- High-speed onboard I/Os with simple motion capability
- Larger number of I/Os with modular extension
- Reuse of existing S500/S500-eCo I/O modules

Pro**For demanding logic, motion and IoT-ready applications**

- Powerful CPU for communication, gateway to IoT applications or motion control
- Larger memory for big applications and web capability
- 2 independent Ethernet interfaces with switch function
- A variety of Ethernet-based protocols
 - For building applications (KNX (1)/BACnet (1))
 - Telecontrol (IEC 60870-5-104)
 - Energy management (IEC 61850 (1))
 - Motion control (EtherCAT (1)(2))
 - SCADA connection
- Coordinated motion with PLCopen library (1)(2) and EtherCAT (1)(2)

(1) Runtime license per CPU required.
(2) In preparation

Please watch our videos on our ABB PLC YouTube channel:



youtube.com/user/abbplc

—
01 AC500 CPUs are locally extendable with up to 10 I/O modules (standard S500 and S500-eCo I/O modules can be mixed).

—
02 Terminal base / Terminal base V3

—
03 Communication module
Up to 4 modules for multiple combinations to communicate on nearly every protocol available
Up to 6 modules can be used with AC500 V3 CPU

—
04 CPU module / CPU V3 module

—
05 S500 Terminal unit

—
06 S500 I/O module

—
07 Pluggable marker holder for S500 I/O modules with template

—
08 S500-eCo I/O module

—
09 Memory cards

—
10 Battery



—
01



—
02



—
03



—
04



—
05



—
06



—
07



—
08



—
09



—
10

PLC Automation product family

AC500 PM595 controller system characteristics

The flagship of the AC500 platform, the AC500 PM595 controller, was designed to be as scalable, flexible and efficient as the entire AC500 range.

With the AC500 CPU PM595, ABB launched a new core for machine control applications. Its high-performance processor with generous memory offers performance, security and reliability for the upcoming challenges of automation applications.

A variety of connectivity capabilities, integrated safety and utilizability even under rough environment provide machine builders with valuable benefits when performing their automation tasks.

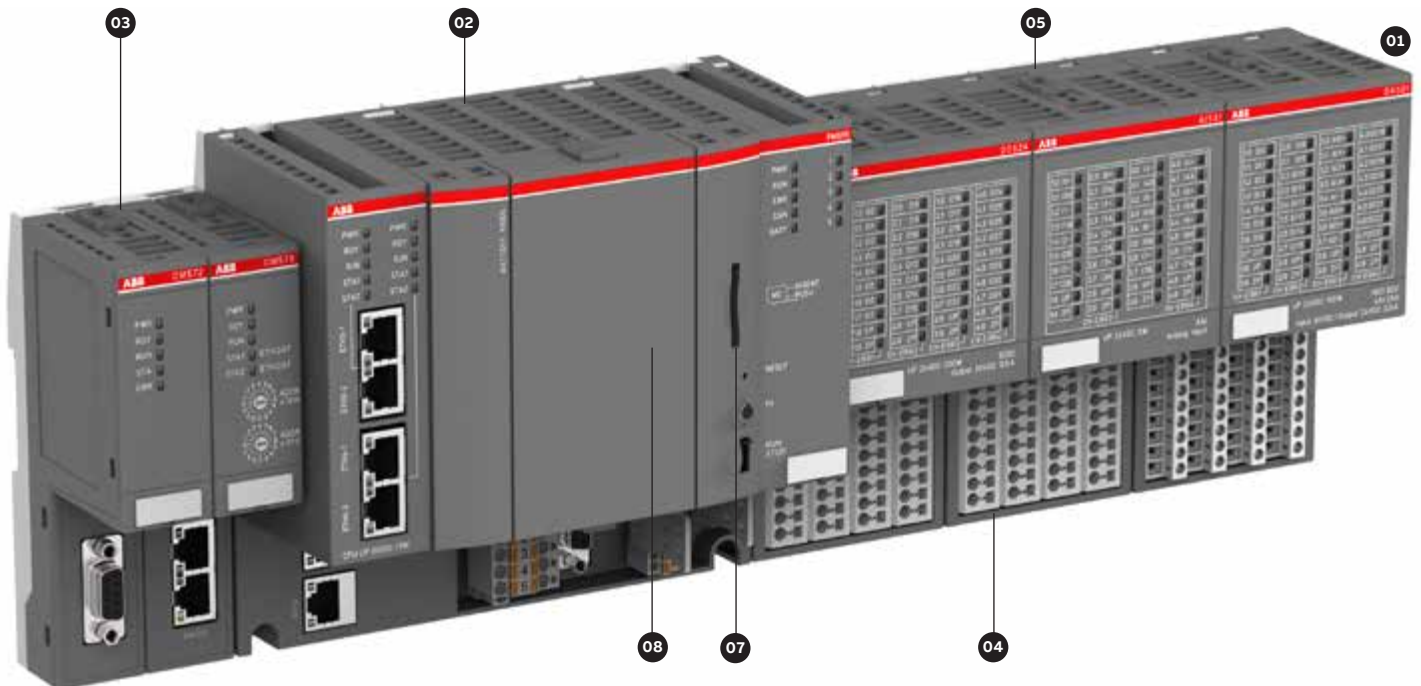

—
01 AC500 CPUs are locally extendable with up to 10 I/O modules (standard S500 and S500-eCo I/O modules can be mixed).

—
02 CPU with integrated connectivity and terminal base

—
03 Communication module.
Up to 2 modules for multiple combinations to communicate on nearly every protocol available and to include functional safety

—
04 S500 Terminal unit

—
05 S500 I/O module

—
06 S500-eCo I/O module

—
07 Memory cards

—
08 Battery

—
09 Pluggable marker holder for S500 I/O modules with template



01



02



03



04



05



06



07



08



09

PLC Automation product family

Condition monitoring system CMS based on AC500

Predictable performance for your operations

Optimize your assets with a condition monitoring system (CMS) based on the proven AC500 platform. The FM502 module can help you to improve your operations resulting in greater efficiency and higher reliability while minimizing service and operating costs.



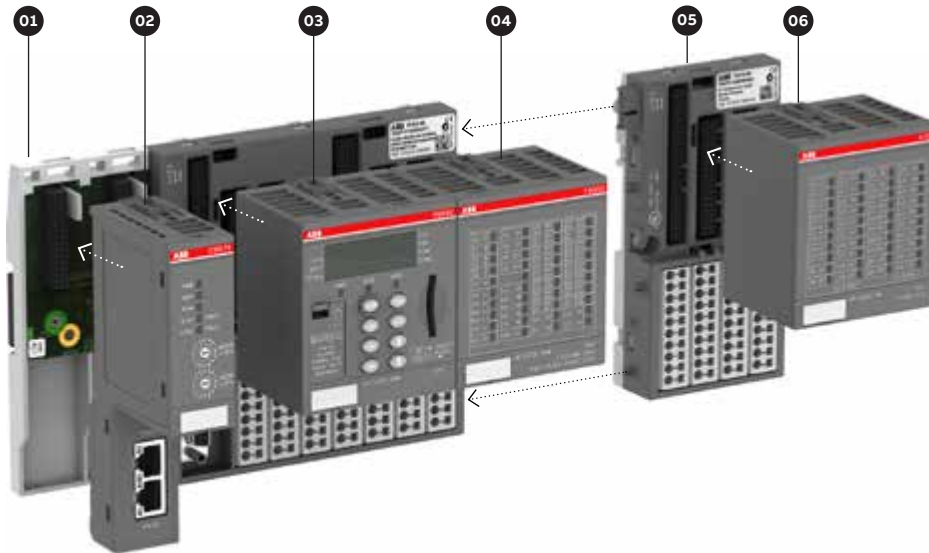

- 01 Terminal base: TF501 or TF521
- 02 Accomodating: 0 - 2 communication modules
- 03 PM592 CPU
- 04 FM502 CMS module
- 05 Extendable by I/O terminal units
- 06 Extendable by further I/O modules

Add predictable performance and productivity
 The CMS module brings further reliability and easy integration with all kinds of machinery systems, enabling precise management of the real-time condition of your operation. This transparency takes your business and productivity to a new level with more efficient machines, predictable performance and significant reduction in maintenance costs.

No matter whether as stand-alone condition monitoring or integrated into machine or process control, the module is perfectly suited to build optimized, self-analyzing automation solutions that simultaneously perform condition monitoring, control, protection, safety and data logger functions with one controller. The fast data logger function also contributes to consistent high quality production, due to the possibility to combine control and production information directly.

CMS also protects against machine failures, unforeseen sudden damage, incorrect installation, and reduces maintenance and wear. Virtually no unscheduled downtimes boost plant availability and reliability.

Advantages

- Planned maintenance rather than spontaneous repair ensures predictable performance
- Approaching damage is identified very early
- Protection against spontaneous failures and operation in critical conditions
- Reduction of costs in maintenance and lost production time
- Plant availability is increased
- Optimum utilization of the aggregates until real end of life
- Simple to use, maintain, adapt or extend

AC500 + CMS = increased machine efficiency

All based on the AC500 platform modularity provides ultimate flexibility: Communication and I/O modules can be added and combined with Safety.

Extendable, robust and proven

- Stand-alone CMS or control integrated
- Can be extended by AC500 communication modules and S500 I/O modules
- Proven and future proof, as based on AC500 platform
- Extreme conditions XC version available
- Fast data logger, e. g. for production quality
- Condition monitoring and fast protection (vibration, current, voltage, speed/encoder)

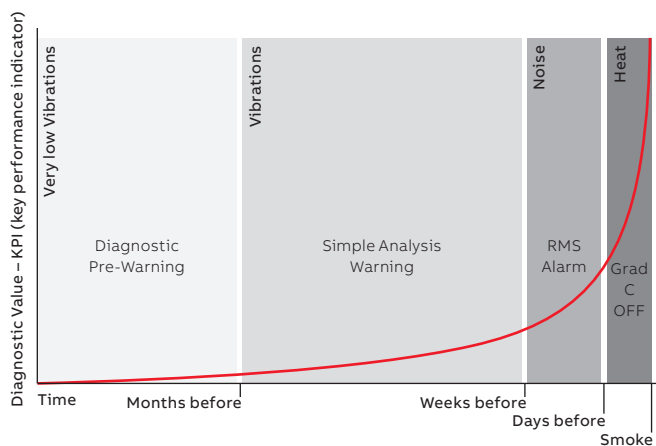

PLC Automation product family

AC500 V3 enhanced connectivity and performance

The V3 features provide even more flexibility and freedom when it comes to connectivity and functions supplied onboard without the need of additional devices as couplers or switches. AC500 V3 is ready for the requirements of IoT and digitalization and secure cloud connectivity via new protocols and functions.

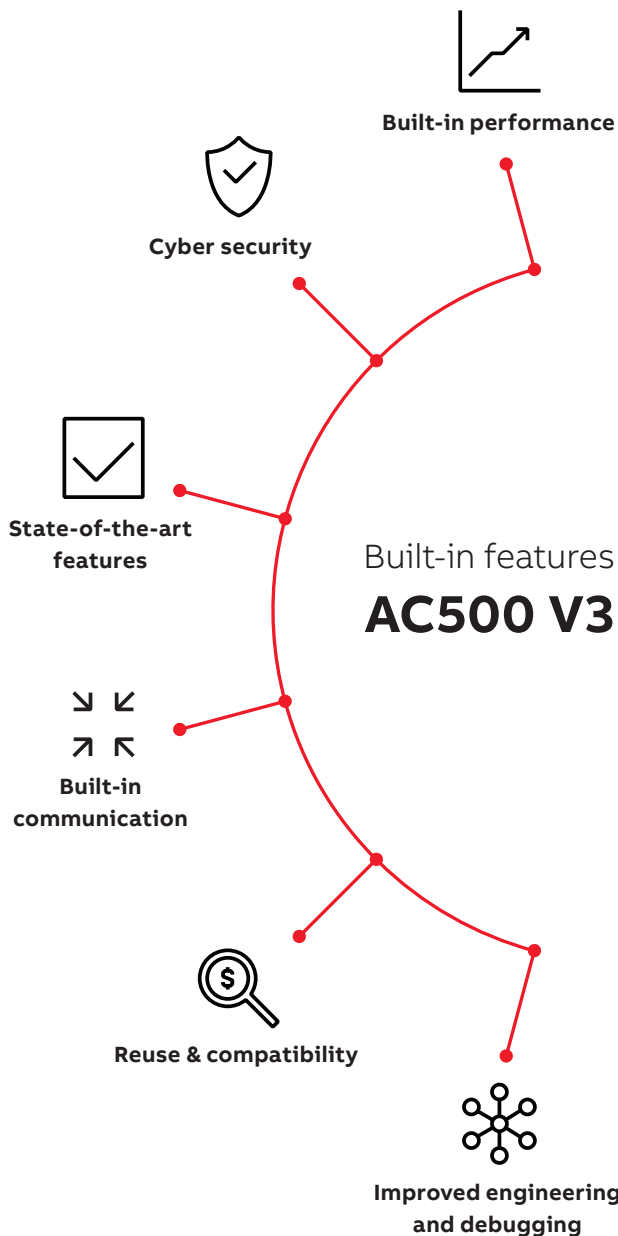

Built-in performance

- Faster CPUs with more powerful processors
- More CPU memory allocated freely
- Modern, state-of-the-art components

Cyber security

- Digitally signed firmware updates protected by hardware security chip
- Secure communication protocols: HTTPS, FTPS, OPC UA, MQTT
- Encrypted communication with engineering system ABB Ability™ Automation Builder and boot application

State-of-the-art features

- OPC UA for easy connectivity to SCADA systems or operator panels
- MQTT for lightweight cloud messaging
- Onboard HTML5 web server technology
- Functional safety support with PROFIsafe communication

Built-in communication

- Two Ethernet interfaces for use as switch or independent ports
- Onboard Ethernet protocol as Ethernet/IP
- CANopen master interface, CAN2A/2B, J1939
- KNX and BACnet
- OPC UA server, OPC DA alarm and event
- IEC 61850
- IEC 60870-5-104 Telecontrol
- DNP3 (1)

Reuse & compatibility

- Reuse with AC500 platform:
 - S500/S500-eCo I/O modules
 - Communication modules
- Project conversion and code re-use

Improved engineering and debugging

- Professional version control with subversion
- Application project management
- Object-oriented programming
- Optimized IEC 61131-3 editors
- Offline simulation capabilities*

(1) In preparation

The flexibility, scalability and footprint of AC500 V2 have been passed on to the new CPU range. Therefore, AC500 continues to be the perfect fit for various applications or will be the natural

successor when you need to introduce new features to existing applications or extend machines and applications to reach for the cloud.

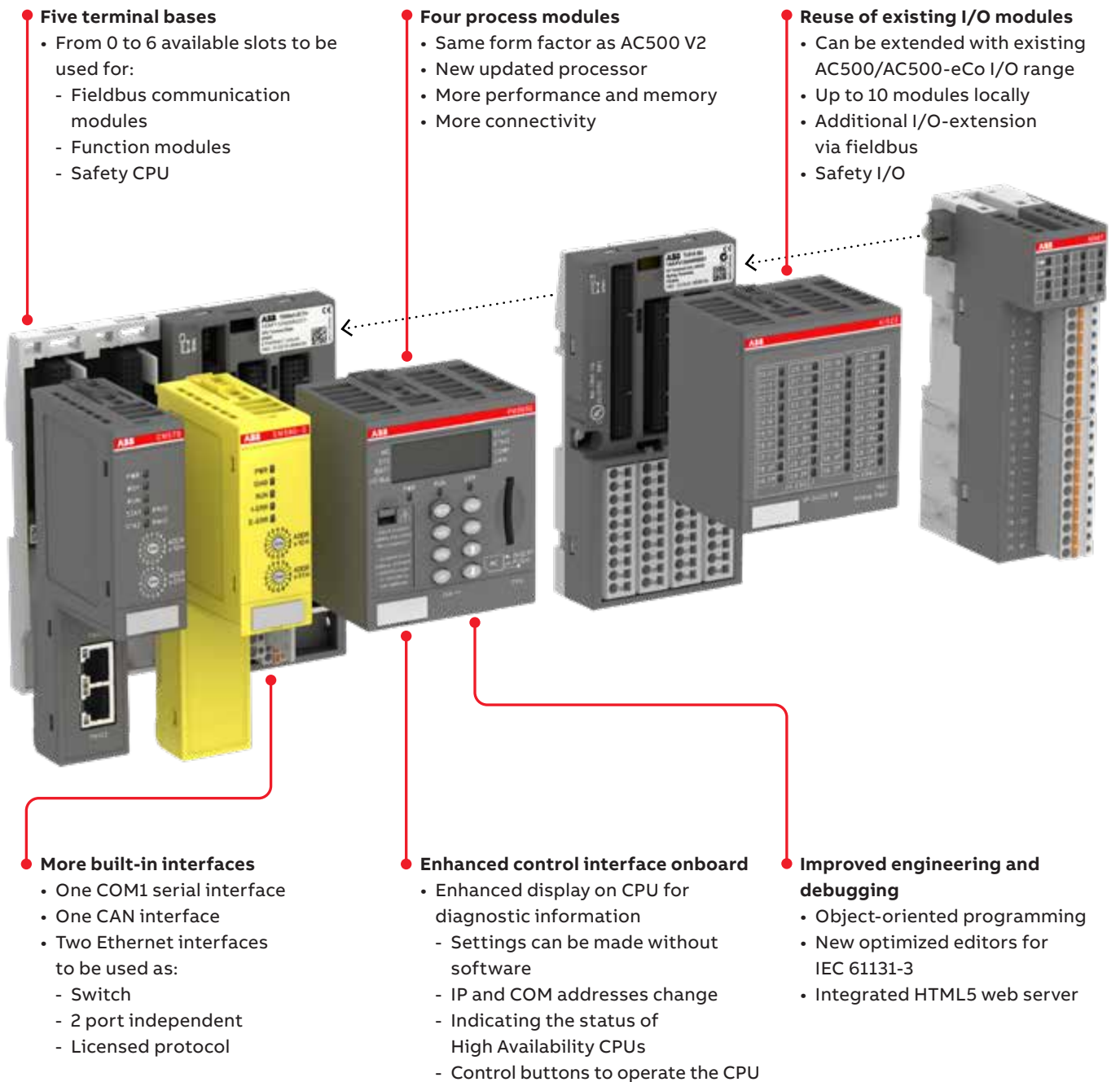

PLC Automation product family

AC500 extreme conditions

AC500-XC – the rugged variant of AC500 for extreme indoor and outdoor conditions.

The PLC AC500-XC is reliable, functionally safe and operational even under rough environmental conditions.





04



01



02



03



05



06



Operation in extremely humid environments

- Increased resistance against 100 % humidity and condensation.



Extended operating temperature

- -40 °C up to +70 °C operating temperature.



Reliable in high altitudes

- Operation in altitudes up to 4000 m above sea level or air pressures up to 620 hPa.



Extended immunity to corrosive gases and salt mist

- G3, 3C2 / 3C3 immunity
- Salt mist EN 60068-2-52 / EN 60068-2-11.



Extended immunity to vibration

- 4 g rms random vibration up to 500 Hz
- 2 g sinusoidal vibration up to 500 Hz.



Extended EMC requirements

- EN 61000-4-5 surge immunity test
- EN 61000-4-4 transient / burst immunity test.

- 01 Terminal base
- 02 Extreme conditions communication module
- 03 Extreme conditions CPU
- 04 Extreme conditions CPU with integrated connectivity and terminal base
- 05 Extreme conditions S500 terminal unit
- 06 Extreme conditions S500 I/O module

PLC Automation product family

AC500-S safety PLC – functional safety

AC500-S safety PLC is the solution for both simple and complex machine and process safety applications requiring maximum reliability, efficiency and flexibility.

This safety PLC protects people, machines and processes, the environment and investments – the ideal choice for hoist, wind turbine, crane, material handling, robot and other factory and process applications.

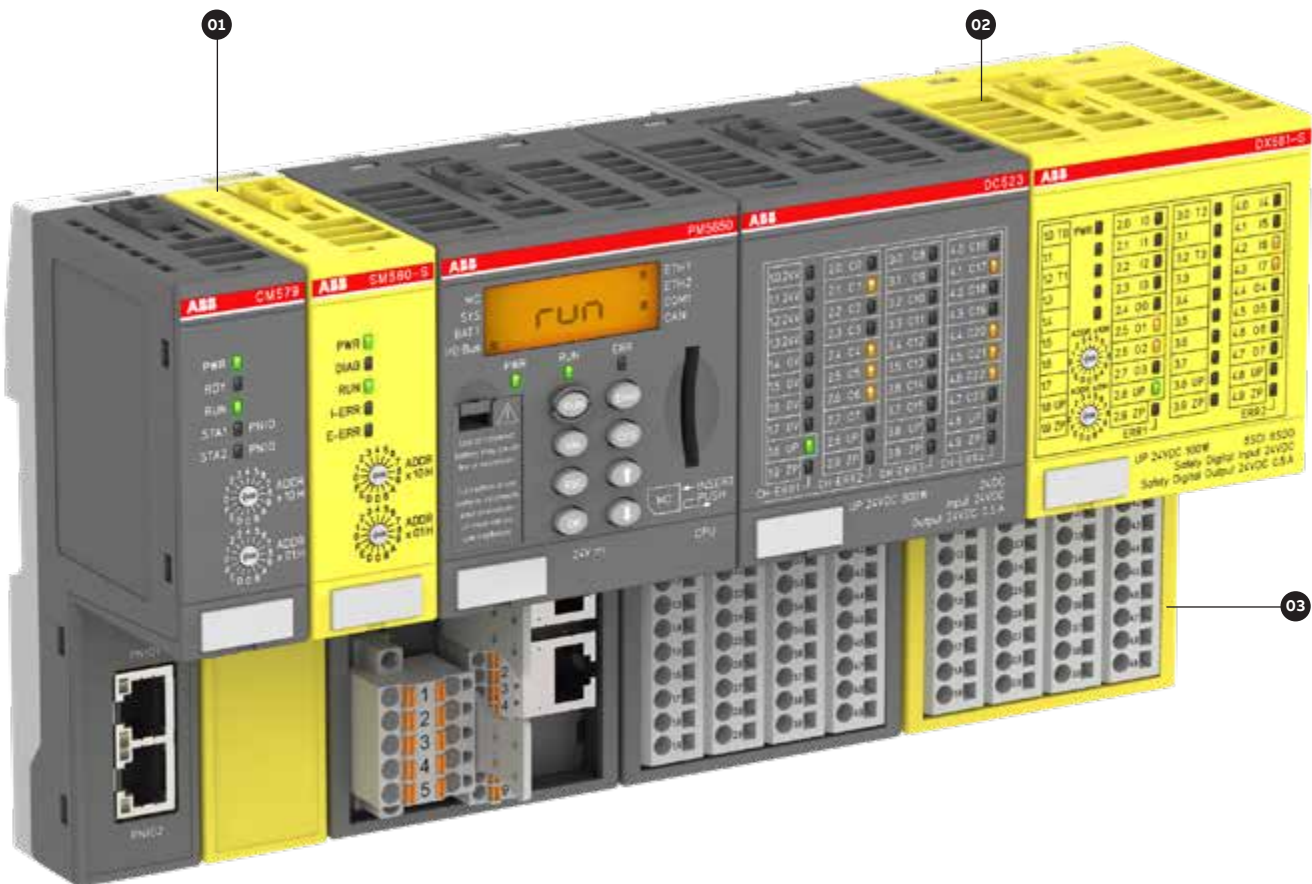

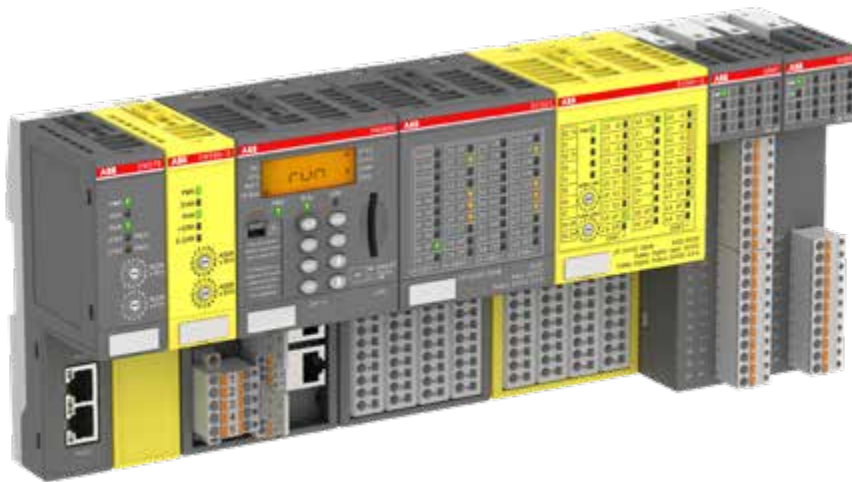

01

- 01 Safety CPU
- 02 S500 Safety I/O module
- 03 Safety terminal unit

Better integration and ease of programming

Featuring a consistent look and feel across the entire range, the AC500 is the PLC of choice for applications where uncompromised flexibility, comprehensive integration and seamless communication are a must.

ABB Ability™ Automation Builder seamlessly integrates your safety application in ABB PLC, Safety, Drives, Motion and HMI. Through integrated standard languages, such as IEC 61131-3, Automation Builder is easy to use, thus, allowing you to get started in virtually no time at all. And what is more: intuitive system configuration using one single tool ensures optimal transparency.

The AC500-S safety PLC facilitates the implementation of even most complex safety applications. Support of safety-relevant calculations, such as COS, SIN, TAN, ASIN, ACOS and LOG makes the AC500-S the ideal solution for crane engineering, wind power generation, robotics and hoisting applications.

Safety programming with Structured Text (ST) and full support for Function Block Diagram (FBD) and Ladder Diagram (LD) programming and advanced features in PROFI-safe over PROFINET communication, like Shared Device functions, gives you greater flexibility and simplifies safety application development. The AC500-S safety PLC is also available in a version for extreme conditions.

PLC Automation product family

Visualization options

PB610 Panel Builder 600 in combination with the CP600 HMI platform provides flexible possibilities for visualization.

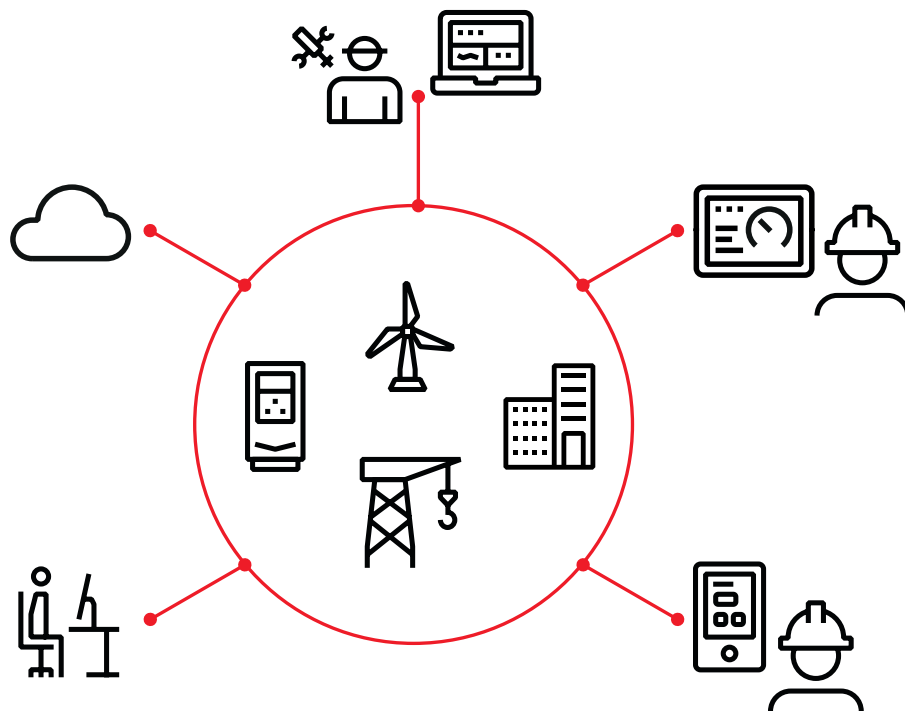

Create your individual faceplate with Panel Builder 600

CP600 control panels with their common engineering tool offer functionalities for many different segments and connected devices.

Thanks to HTML5-based pages, HMI client and VNC client, it is possible to access your visualization from nearly everywhere, no matter whether you use an HMI, a PC, a tablet or a smartphone.

Connecting to the web from the panel with the preinstalled Chromium browser is very easy and allows access to AC500 V3 web visualization or other web-based information.

Functionalities like an integrated user access management and regular cyber security checks ensure that everything runs in a secure and controlled way.

PLC Automation product family

PB610 Panel Builder 600



Stay in one environment

Integration of PB610 into ABB Ability™ Automation Builder for perfect interaction between CP600 and AC500 devices

Reduce risk

Reusable and scalable configuration to manage complexity and realize connectivity easily

Increase efficiency

Use state-of-the-art widgets for programming native HMI and web visualizations

Customize solutions

Create your own or customize existing widgets easily to develop a tailor-made solution for your needs

Combine the tools

The PB610 runtime license allows you to use your Windows PC as an HMI

PLC Automation product family

PB610 Panel Builder 600

PB610 Panel Builder 600 software is integrated in the ABB Ability™ Automation Builder engineering suite and can be downloaded via Automation Builder installer. The engineering software is intended for the efficient design of flexible HMI applications in a multiplicity of automation solutions.

It includes for instance the following features:

- Vector graphics (*.SVG) for precise, easily scalable and dynamic HMI design.
- Alpha blending for realistic transparency effects.
- Libraries including rich sets of widgets – ready-to-use graphical objects.
- Easy creation of customized widgets through the combination/modification of standard widgets.
- Customized widgets clearly arranged in user galleries.
- Page templates for professional design.
- Numerous configuration options for all HMI elements.
- Realization of customized functions and individual dynamic manipulation via the Java Script with debugger.
- Easy data acquisition and trend presentation.
- Reliable user management and secure access control.
- Rich set of configurable features: dynamic objects, data acquisition, alarm handling, multi-language applications, recipes, ...
- HMI simulation for efficient commissioning.
- Numerous drivers for easy connection to e.g. PLCs, drives, robots.
- OPC UA and MQTT for future-oriented cloud connectivity and IoT.
- Gateway function for easy data exchange between different protocols and systems.

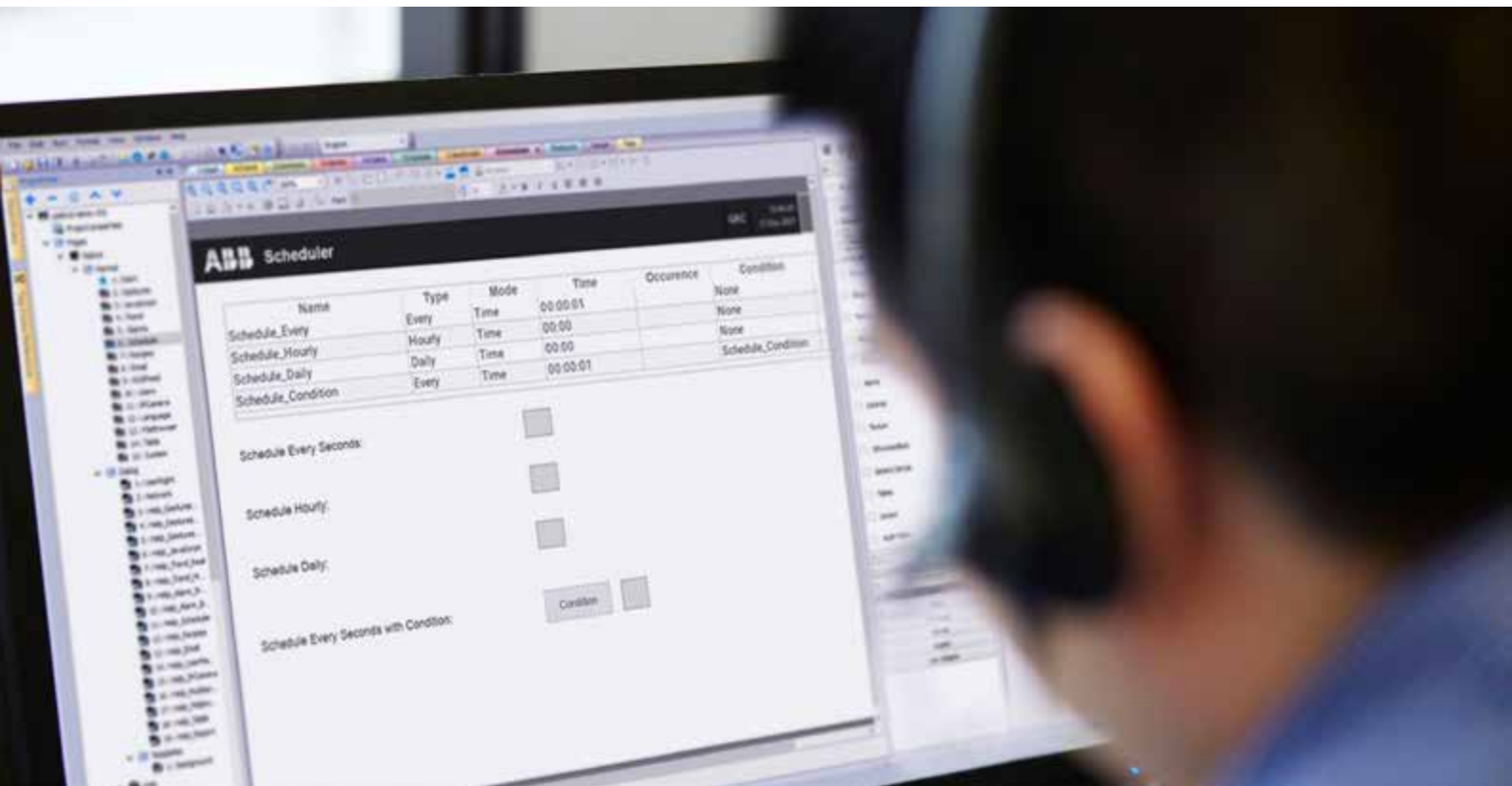

PLC Automation product family

CP600 connectivity

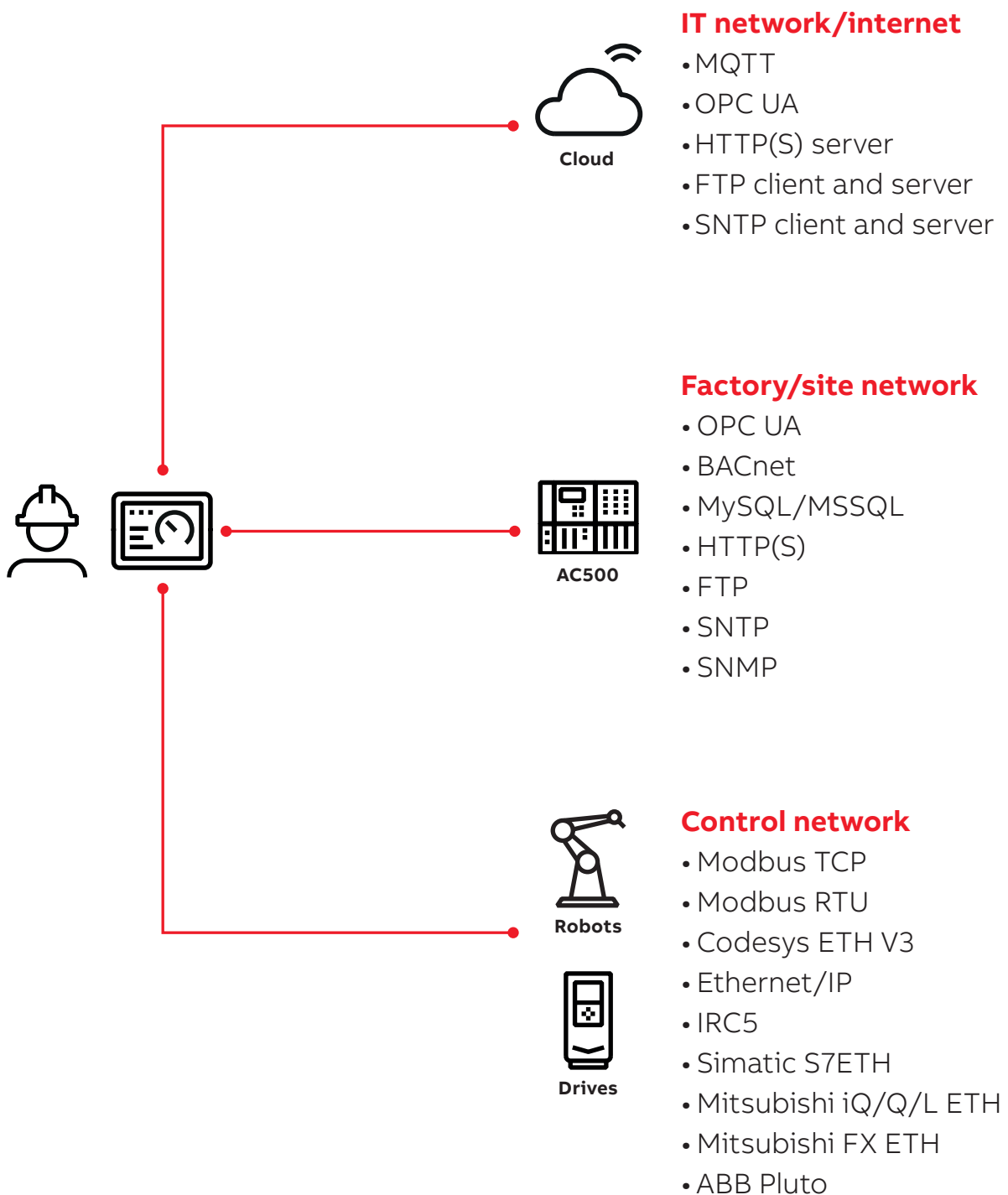

PLC Automation product family

CP600 control panel platform at a glance ...

With comprehensive but easy-to-use functionalities, ABB control panels stand out from competitor products. At a single touch, they intuitively provide operators with tailor-made operational

information for production plants and machines. CP600-eCo, CP600 and CP600-Pro control panels make machine operation efficient, predictable and user-friendly.

Comprehensive CP600 control panel platform for different applications

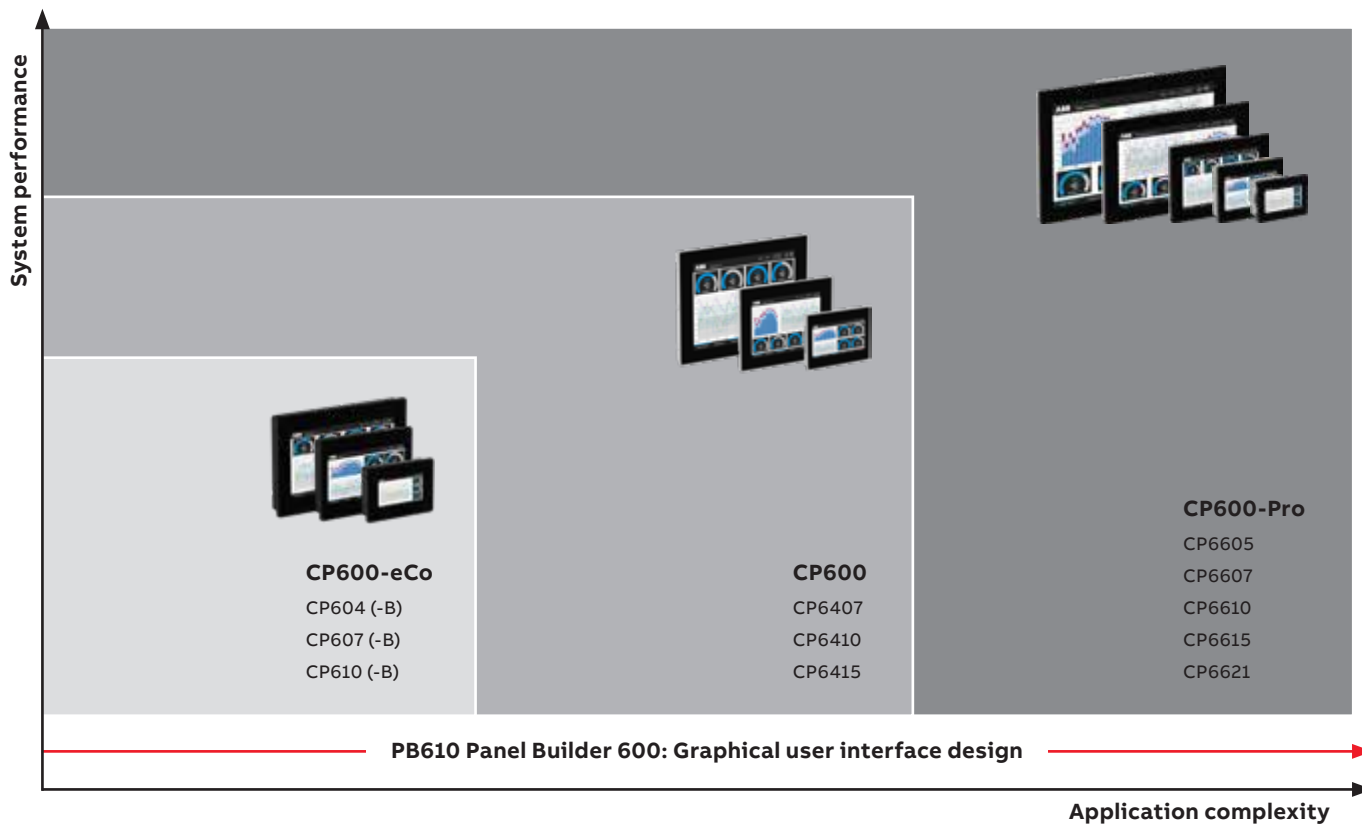

PLC Automation product family

What does your application need?

	CP600-eCo	CP600	CP600-Pro
Screen sizes	4.3", 7", 10.1"	7", 10.4", 15"	5", 7", 10.1", 15.6", 21.5"
Operation	single-touch	single-touch	multi-touch
Communication	1 SER, 1 ETH, 1 USB	1 SER, 2 ETH, 2 USB, 1 SD	1 SER, 3 ETH (1), 2 USB (2), 1 SD
Operating temperature	0...50 °C	-20...+60 °C	-20...+60 °C
Enclosure	plastic / glass + front foil	aluminum / glass + front foil	aluminum / real glass
Front design	ABB or black	black	black
Operating system	Linux	Linux	Linux
PB610 application	60 MB	150 MB	240 MB (3)
Chromium browser	CP610: preinstalled	preinstalled	preinstalled

(1) CP6605: 2 ETH

(2) CP6605: 1 USB

(3) CP6605: 60 MB



PLC Automation product family

CP600-eCo control panels

Suitable for many different applications

To match the design of your machine, CP600-eCo control panels are available in the screen sizes 4.3", 7" and 10.1" with a black or an ABB design front foil. All panels can be mounted in portrait and landscape mode. Their plastic housing has a depth of just 29 mm to save cabinet space.

Engineering with Panel Builder 600, which is part of the ABB Ability™ Automation Builder, ensures easy scalability and combination with other CP600 ranges and AC500 PLCs.

Flexible connectivity

Protocols for ABB PLCs, machinery and motion drives for Ethernet and serial connection make these control panels the first choice for entry-level ABB automation solutions and allow you to configure your network the way you want.

Furthermore, through OPC UA as well as MQTT client and server functions, the panels are well prepared for future communication solutions. Therefore, they offer one Ethernet interface, one serial interface as well as a USB host for flexible data storage and easy updating.

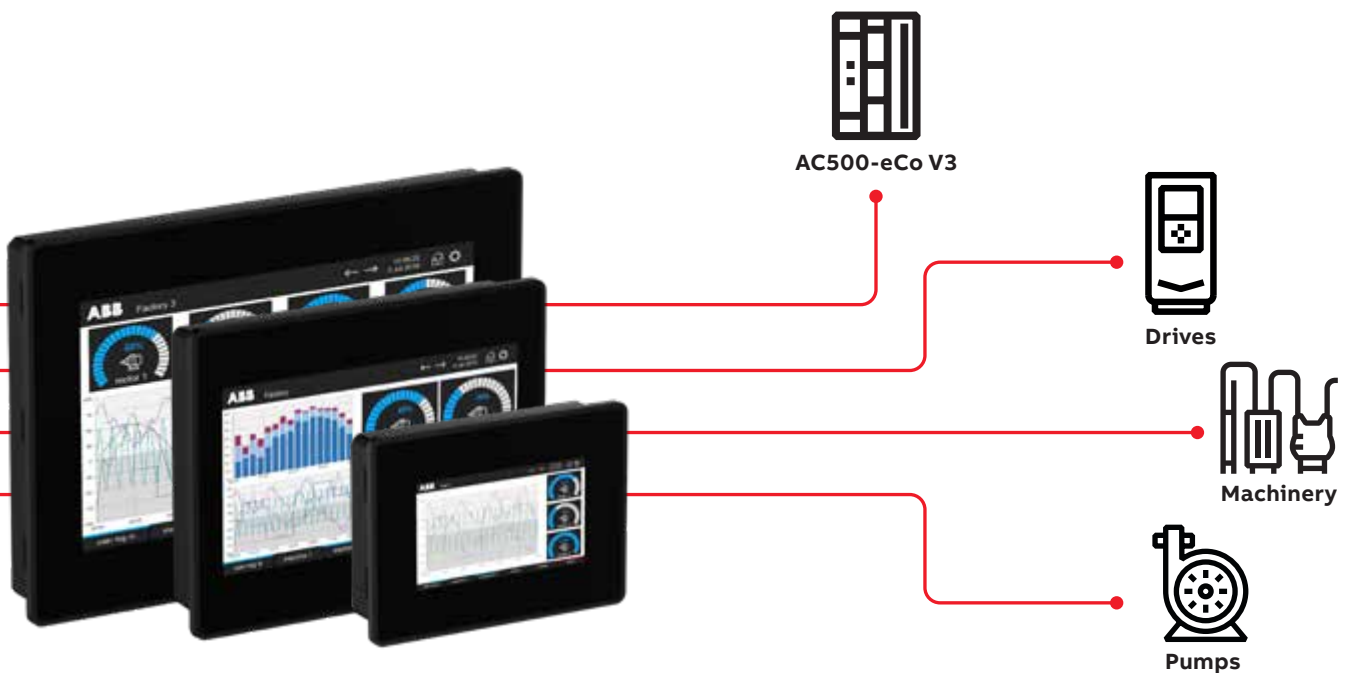



The CP600 platform is many customers' first choice for their individual visualization projects.

PLC Automation product family

CP600 control panels

State-of-the-art HMI range for diverse applications

The CP600 control panels are ready to meet your individual needs. To support a wide range of applications they are available in screen sizes of 7", 10.4" and 15". Panel Builder 600 as part of the ABB Ability™ Automation Builder ensures efficient engineering, scalability and cyber security through regular updates.

Thanks to OPC UA and MQTT in combination with a powerful CPU, these panels are prepared for future communication trends and support cloud connectivity. The AC500 V3 web visualization can be accessed easily with the integrated Chromium browser.

Two Ethernet ports and a serial port enable connections to the web, PLCs, drives or IRC5 robots via multiple protocols to provide the right solution for your application.

Up-to-date hardware design

The robust aluminum enclosure has a modern, industrial look and carries all interfaces on one side, so that installation in various locations is made possible. The wide operating temperature range from -20 up to +60 °C makes these panels suitable even for challenging environments. Landscape and portrait mounting options provide installation flexibility.

2 Ethernet interfaces 10/100 Mbit with configurable bridge mode for easy connectivity with different components are available in combination with a serial interface. For updating, data storage and accessory connections, the control panels offer 2 USB hosts and a memory card slot.

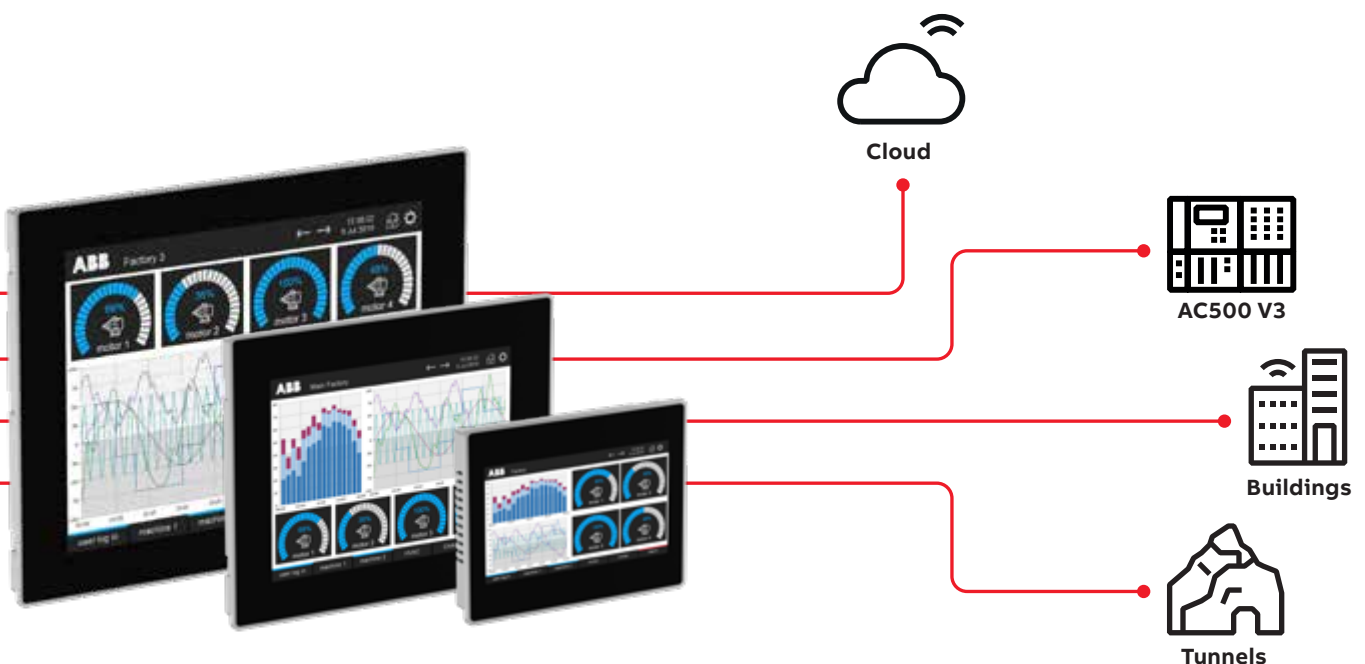



CP600 control panels are your interface to the application.

PLC Automation product family

CP600-Pro control panels

Outstanding HMI range designed for challenging applications

The CP600-Pro series is a powerful HMI series for challenging applications and offers five different variants with multi-touch screens from 5" to 21.5". Real glass fronts, aluminum housing and an increased operating temperature range of -20...+60 °C make them the first choice even for harsh environments. They are also certified for different marine applications.

Efficient engineering of individual visualizations is ensured by PB610 Panel Builder 600, part of ABB Ability™ Automation Builder. In addition to all the functionalities in combination with AC500 PLCs provided by PB610, the CP600-Pro (7" to 15") is also able to trigger safety actions in combination with AC500-S safety PLC.

Advanced connectivity

A wide range of protocols enables the panels to be used as gateways, and to connect to the IoT, clouds, PLCs, drives, robots or other automation components.

To increase connectivity, the HMIs come with up to 3 Ethernet interfaces with different physical layers as well as a serial port to comply with current and future communication requirements. USB hosts and a memory card slot are available for updating, data storage and accessory connection.

The AC500 V3 web visualization can be accessed easily with the integrated Chromium browser.

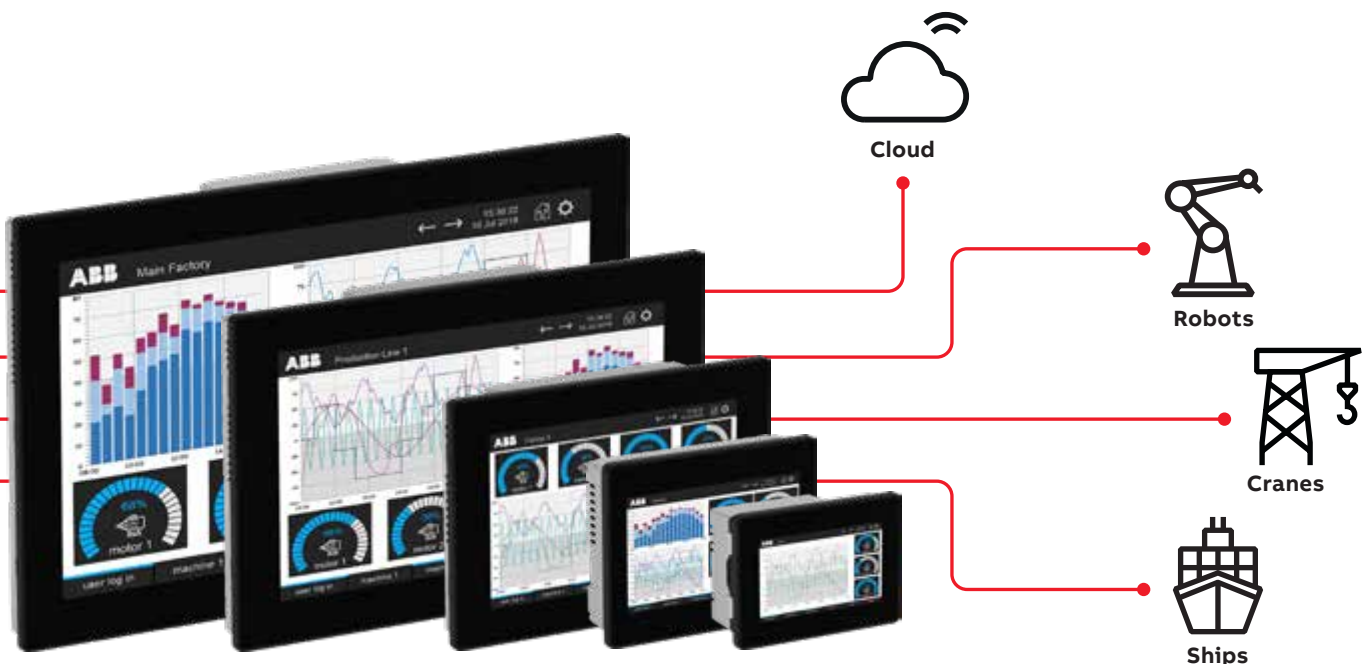



The CP600-Pro control panels (7"... 15") can also be used to trigger safety actions in combination with AC500-S.

PLC Automation product family

PLC Automation website – online tools

The new.abb.com/plc website is a mine of information on our products and documentation.



ABB Home Offerings PLC Automation

You can view this page in: EN DE IT PL SV FI DK JA DA PT

LDG IN

PLC Automation

ABB's automation devices deliver solutions with high performance and flexibility to be effectively deployed within diverse industries and applications including water, building infrastructure, data centers, renewable energy, machinery automation, material handling, marine and more.

Follow us

Are you looking for support or purchase information?
[Contact us](#)

01 Programmable Logic Controllers PLCs

02 AC500-eCo V3

Automation Builder

03 Control panels

Legacy products

05 News and highlights

Motion control with AC500 PLCs - complex motion, simple engineering

AC500 PLC - Uninterrupted data logging with IEC 60870-5-104 telecontrol

AC500 PLC - Boosting productivity in rolling mills at Alleima

AC500 PLC - Secure the flow of water because every drop counts

06 PLC technology

PLC Automation main catalog pdf

ABB Access - unlocking your drives, motors and PLCs

PLC technology - applications, products and features

CP600 drives faceplate

References and customer stories

Product and application videos

07 Popular links

Application examples selector

Main catalog flipbook

Industry solutions

Documents & downloads

Training & support

ABB Channel partner network

08 Related products

Drives

Robotics

Distributed control systems

Safety solutions

ABB zenon

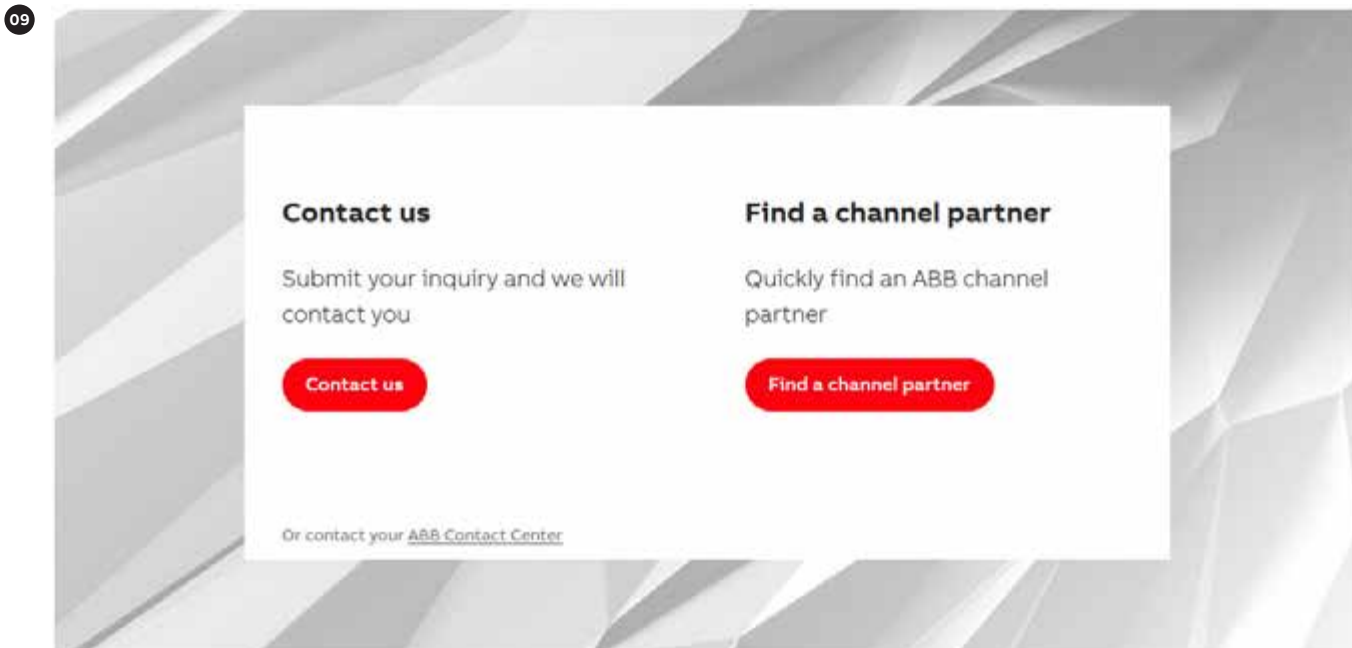

01 – Programmable Logic Controllers PLCs

- AC500-eCo (CPUs, S500-eCo I/O modules, Accessories)
- AC500 (CPUs, Communication modules, Communication interface modules, S500 I/O modules, Accessories, Condition Monitoring CMS)
- AC500-XC (CPUs, Communication modules, Communication interface modules, S500 I/O modules, Accessories, Condition Monitoring CMS)
- AC500-S (CPUs, S500 I/O modules)

02 – Automation Builder engineering suite

- Download link
new.abb.com/automationbuilder

03 – Control panels

- CP600-eCo (Devices, Software, Accessories)
- CP600 (Devices, Software, Accessories)
- CP600-Pro (Devices, Software, Accessories)

04 – Legacy products

- AC31 and previous series
- Control Builder
- CP400
- CP500
- DigiVis 500
- Wireless products

05 – News and highlights

- Articles, videos, product news, success stories and more

06 – PLC technology

- Applications, products and features
- [ABB Access](#)
- References
- Videos

07 – Popular links

- [Application examples selector](#)
- [Main catalog](#)
- Industry solutions
- [Documents & Downloads](#)
- [Training & support](#)
- Partner network

08 – Related products

- Drives
- Robotics
- Distributed control systems
- Safety solutions
- ABB zenon

09 – Contact information for your country

- [Contact us](#)
- [Find a channel partner](#)

Please watch our videos on our ABB PLC YouTube channel:



youtube.com/user/abbplc

Application descriptions and features

- 062–063** **AC500 digitalization for a more productive and sustainable future**
- 064–065** **AC500 as IoT gateway**
- 066–067** **IEC 61850 protocol for substation and switchboard automation with AC500**
- 068–069** **Water automation with AC500**
- 070–071** **Future-proof building automation with AC500**
- 072–073** **Building automation with AC500, KNX and BACnet**
- 074–075** **Tunnel automation with AC500**
- 076–077** **AC500 HA offers hot standby redundancy**
- 078–079** **Hot Swap of S500 I/O modules for increased availability**
- 080–081** **S500 I/O modules run with various controllers**
- 082–083** **Integration of AC500 PLC into ABB Ability™ System 800xA**
- 084–085** **Condition Monitoring with AC500 PLC**
- 086–087** **Machine controllers based on AC500 PLC**
- 088** **Real-time Ethernet functionality**
- 089** **AC500 as advanced RTU controller**
- 090–091** **Safer, greener and more productive with AC500-S safety PLC**
- 092–093** **Embedding safety I/Os in ABB robots enhances man-machine collaboration**
- 094–095** **Safe communication between safety CPUs using PROFINET/PROFIsafe over 5G**
- 096–097** **Triggering safety actions using standard HMI**

Application descriptions and features

AC500 digitalization for a more productive and sustainable future

How to bring your process data safely to your cloud

Secure your site investment with AC500 V3

No matter whether you are managing one small machine or a large site, obtaining clear information is equally important.

No matter whether there are a few signals or 1000 signals, the AC500 can be adapted easily to exact requirements with secure cloud protocols already from basic PLCs or HMIs.

AC500 V3 the perfect data collector

AC500 V3 can easily connect with many different control systems on site.

Since AC500 is not restricted to particular protocols it is easy to find the right protocol or I/O module to receive or send data.

The huge computing capacity of the CPUs allows connection to several hundred systems and sending and/or receiving data via secure protocols such as OPC UA, MQTT to/from any open cloud application.

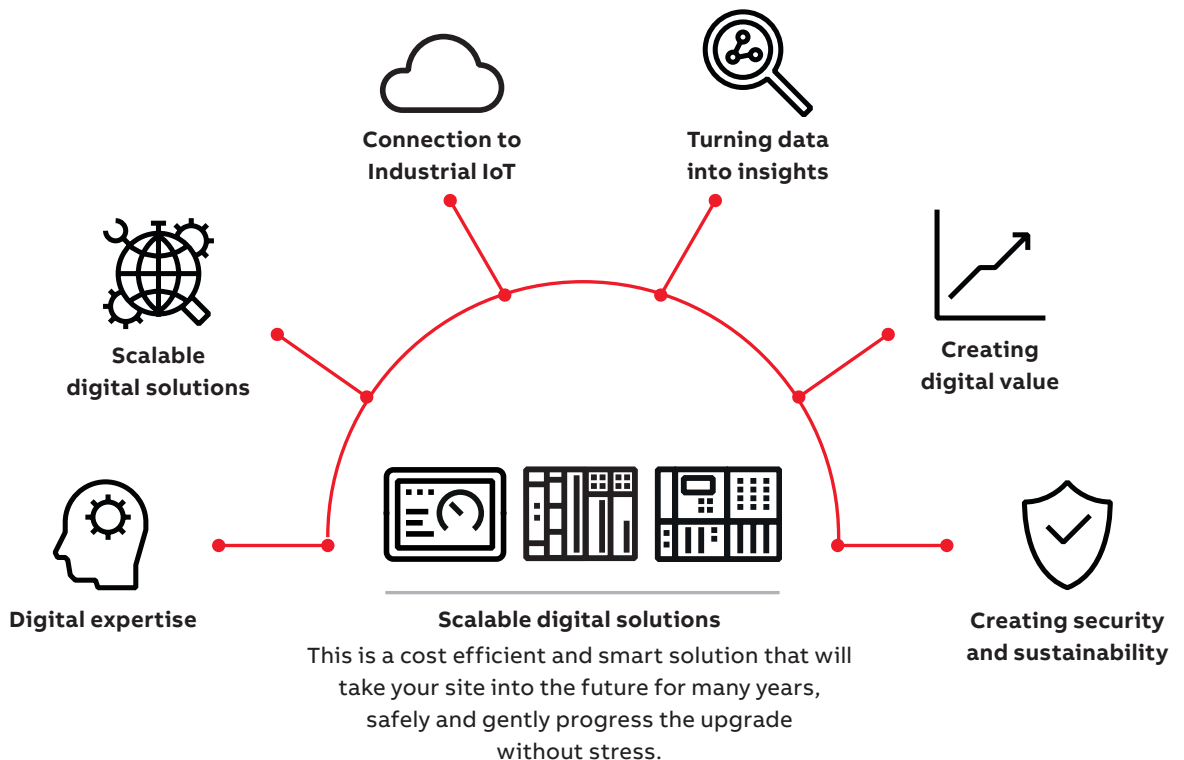



Digital expertise

ABB Ability™ brings together all of ABB's digital expertise to create real business value for customers.



Turning data into insights

Make raw data available for evaluation, present findings in a strategic way and take actions.



Scalable digital solutions

From easy connectivity to integrated and optimized services and expertise all the way through to customer support, system analysis, automation and optimization.



Creating digital value

Collect information, make decisions and set priorities on the basis of these findings.



Connection to Industrial IoT

Connectivity and software innovation enable real-time, data-driven decisions for safer, smarter and more sustainable industrial operations.



Creating security and sustainability

Certified for "Secure product development lifecycle requirement" as well as secure connections to encrypt data from being exposed.

Application descriptions and features

AC500 as IoT gateway

Cost efficient and extendable solution

- Scalable & platform-independent cloud connectivity
- Adaptable functionality through interchangeable modules
- Smart data handling on edge-level for cost-efficient cloud-solutions

Connection of a single controller

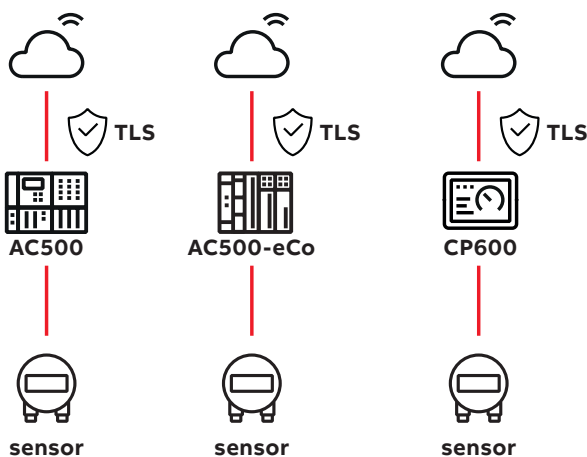

Security level: optimized for remote units

AC500 works as edge-gateway and is directly connected to the cloud. Security is established through TLS encryption.

Benefits:

- No additional gateway required
- Low latency

Application:

Small systems with non-critical data transfer.

Connection of a secured network

Security level: advanced

Connection of the whole AC500 network to the cloud using CP600 HMI or a separate gateway.

Enhanced security is provided through an integrated firewall in CP600 or via additional firewall and/or VPN through a separate gateway.

Depending on the application some additional ports must be opened to access different services.

Benefits:

- Advanced level of security
- Easy integration of many edge devices

Application:

Large systems with many devices which need higher protection.

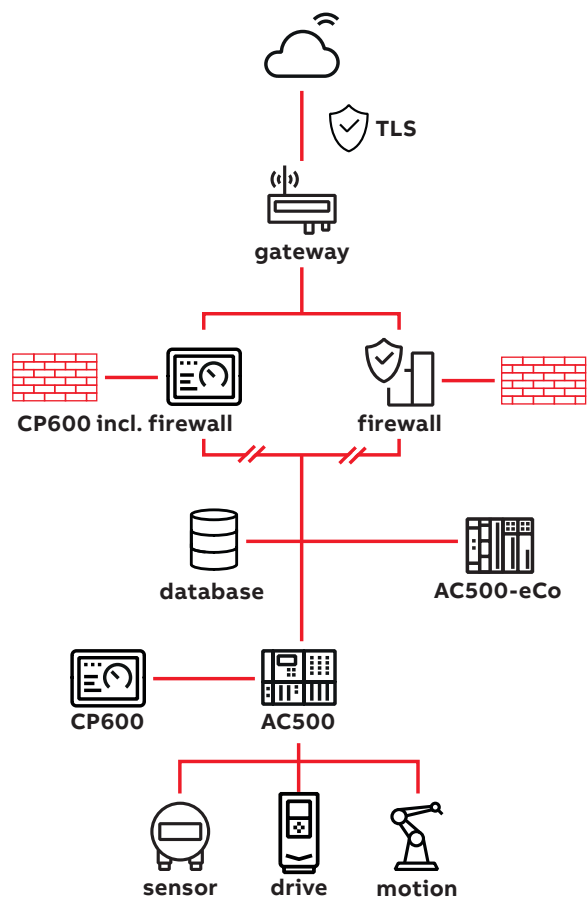

IoT controller

Application

Demanding applications with a larger system architecture and complex data handling (e.g. remote data logging for drives/winch control)

Benefits

Easy cloud connection of whole system, active control of transferred data, advanced control functionalities

IoT controller advanced

Application

Applications with functional safety requirements which need additional functionality (e.g. functional safety control for cranes)

Benefits

Ensured safety for machines and staff

IoT data center

Application

Critical assets that need permanent protection & monitoring (e.g. vibration monitoring for pumps)

Benefits

Permanent asset protection, increased resilience to internet outages, cost efficient monitoring

IoT gateway

Application

Small applications with simple I/Os and direct data transfer (e.g. energy monitoring of radio towers)

Benefits

Cost-efficient, resource-friendly, low implementation effort



Application descriptions and features

IEC 61850 protocol for substation and switchboard automation with AC500

AC500 as freely programmable 61850 controller, gateway or IED

AC500 is used as Intelligent Electronic Device (IED), RTU or controller

IEC 61850 is a standard protocol for state-of-the-art, future-proof substation automation, which replaces hard wiring of signals by communication over the network. The AC500 V3 can be programmed to act as an Intelligent Electronic Device (IED), RTU or used in control applications such as e.g. load shedding.

Interoperability between devices made easy

Generic Object-Oriented Substation Event (GOOSE) messages are used for the interoperability of devices with minimal delay, e.g. for fast tripping or interlocking or monitoring applications. With the IEC 61850 library and the comfortable communication the AC500 PLC can be used for the publishing of and subscribing to GOOSE messages. The IEC 61850 protocol of the AC500 PLC is TÜV certified.

The AC500 PLC can also act as server for connection-oriented communication according to the Manufacturing Messaging Specification (MMS).

Easy engineering

ABB Ability™ Automation Builder integrates the IED configuration which supports the import and export of files in the Substation Configuration Language (SCL) and code creation for the AC500. SCL allows transferring configuration information between various IEDs. The functionality of the devices can be programmed in IEC 61131 languages with Automation Builder.



Integral solution

All-in-one platform 60870-104, 61850, Modbus, combined with OPC DA, OPC UA, MQTT. Automation Builder Engineering with the comfortable IED configuration tool and flexible IEC programming functionality and C-code integration.

Application example 61850

AC500 can precisely control and monitor all levels (switchboard, substation and process) and connect them via 61850 or interface to the outside world (RTU).

AC500 can interface to a large amount of IEDs and map their data in control and monitoring direction to a 60870-5-104, OPC UA or MQTT communication as required or act on other IEDs e.g with advanced logic in load shedding control applications. AC500 can also help to modernize and digitalize an existing and aging infrastructure.

Please watch our videos on our ABB PLC YouTube channel:



youtube.com/user/abbplc

AC500 application levels

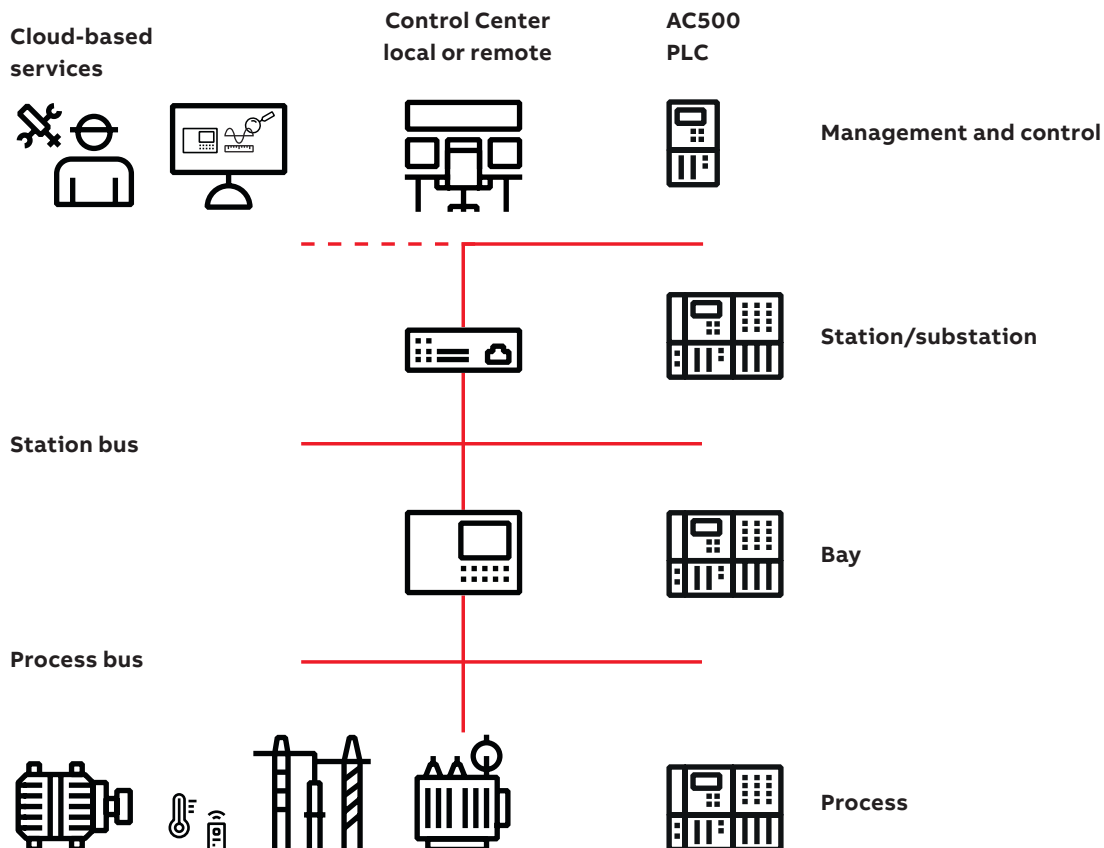

Application descriptions and features

Water automation with AC500

More than 6 billion people are expected to live in cities by 2040. Therefore, we need smart cities that use data to optimize resources, improve people's quality of life, and help businesses to thrive. A clean, readily available water supply and wastewater disposal systems are essential to public health. This means that wastewater treatment processes need to be optimized. From small pumping stations to controlling complete plants, ABB offers one-platform solutions scaling for a safe, reliable water supply.

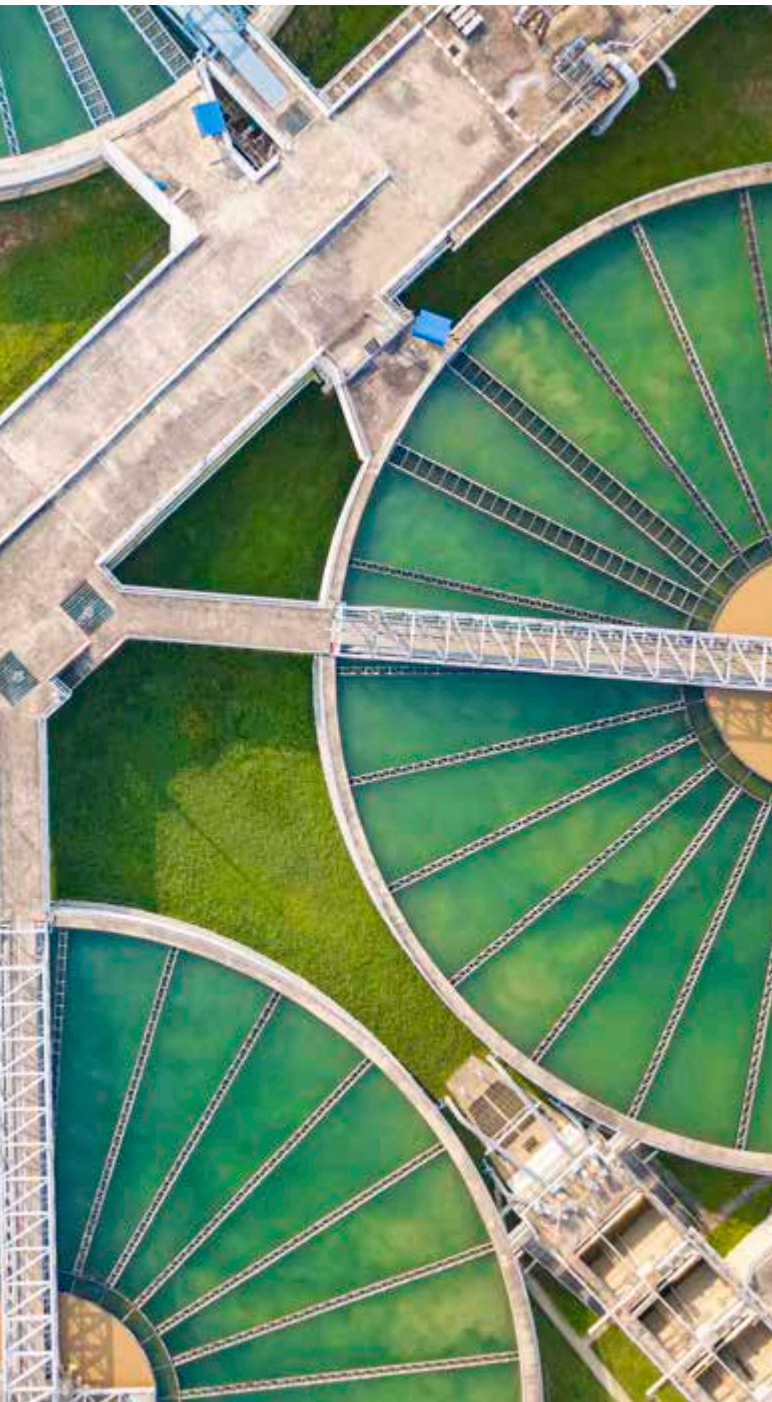

Maximize energy efficiency with the AC500 PLC
As the “brain” of the water supply, the AC500 PLC knows everything about the water flow. It ensures optimal performance, maintains a reliable and safe flow of water and wastewater, and keeps the entire water system in balance. The PLC shares the information to the drives controlling the motor speed for an optimum water flow rate while keeping energy consumption low.

The AC500 PLC provides many communication and I/O options. S500 I/O modules as a part of the AC500 PLC platform offer a cost-efficient solution with low technical barriers for high reliability in water and wastewater plants. In addition, hot swap modules for higher availability support efficient operations.

The PLC connects sensors and actuators like drives or valves for remote or centralized monitoring and control. The PLC AC500-XC and its I/O system S500-XC ensure high availability even in harsh environments and withstand wider temperature ranges as well as corrosive gases.

The CP600 control panel platform features various visualization options. In addition, ABB provides special AC500 libraries for the water industry. These libraries enable the configurable use of advanced pump functions, data storage, remote access and reliable data transmission.

Please watch our videos on our ABB PLC YouTube channel:



youtube.com/user/abbplc



Solution package

- Automation Builder engineering suite for the entire portfolio
- Library packages suitable for water applications, including ABB Drives library with ready-made function blocks
- Wide range of HMIs with the CP600 control panel platform



Customer benefits

- High compatibility: Easy integration (also in existing SCADA systems), usability and modularity
- Efficient engineering: Pump functionalities and drives can be programmed quickly and easily
- Increased productivity and reliability
- Reduced downtime
- Short delivery lead time
- Strong application and product support



Protection and security

- Open connectivity for easy integration with highest level of cyber security
- Security – Achilles Level 2 and IEC 62443-2



Protocols

- MQTT, OPC UA, IEC 61850, Modbus RTU/TCP and many more
- Onboard datalogger with auto-refill based on IEC 60870-5-104 (telecontrol)

The descriptive and interactive landscape below contains links to web pages, brochures, infographics and images. You can access it with your tablet or PC. Scan the QR code now to discover ABB solutions for smart societies, and to find out how AC500 supports the water industry.



smartsocieties.abb.com



Application descriptions and features

Future-proof building automation with AC500

AC500 as freely programmable building automation controller

Sustainability and profitability

Connecting the Building Automation Management System via AC500 to central and floor or room level functions guarantees efficient integration and best fit function of critical building systems, securing automation investment for the future. ABB's automation products can include control and monitoring of all up-to-date assets in a building like e.g. solar panels and integrate them to the energy management including e.g. storage and scheduling or shedding of loads. Overall this reduces consumption and maintenance costs, thereby considerably increasing the cost-effectiveness of buildings.

Monitoring and control

In commercial buildings the reliable operation and control of critical functions like doors, access systems, escalators and elevators is important

for e.g. a safe and secure operation even in emergency situations. AC500 can also control, monitor and interlock the electrical switchboards as well as all subsystems and their functionality and provides valuable information in case of energy loss on some feeders or malfunction. It can enable monitored and available backup power systems to kick in and service personnel to respond and fix errors rapidly. In case of problems AC500 can manage emergency lighting and provide 24/7 availability to protect people in the building.

Access control and monitoring of charging stations in parking spaces is another asset of AC500 which can be included in the energy management and monitoring locally, remotely or via cloud services.

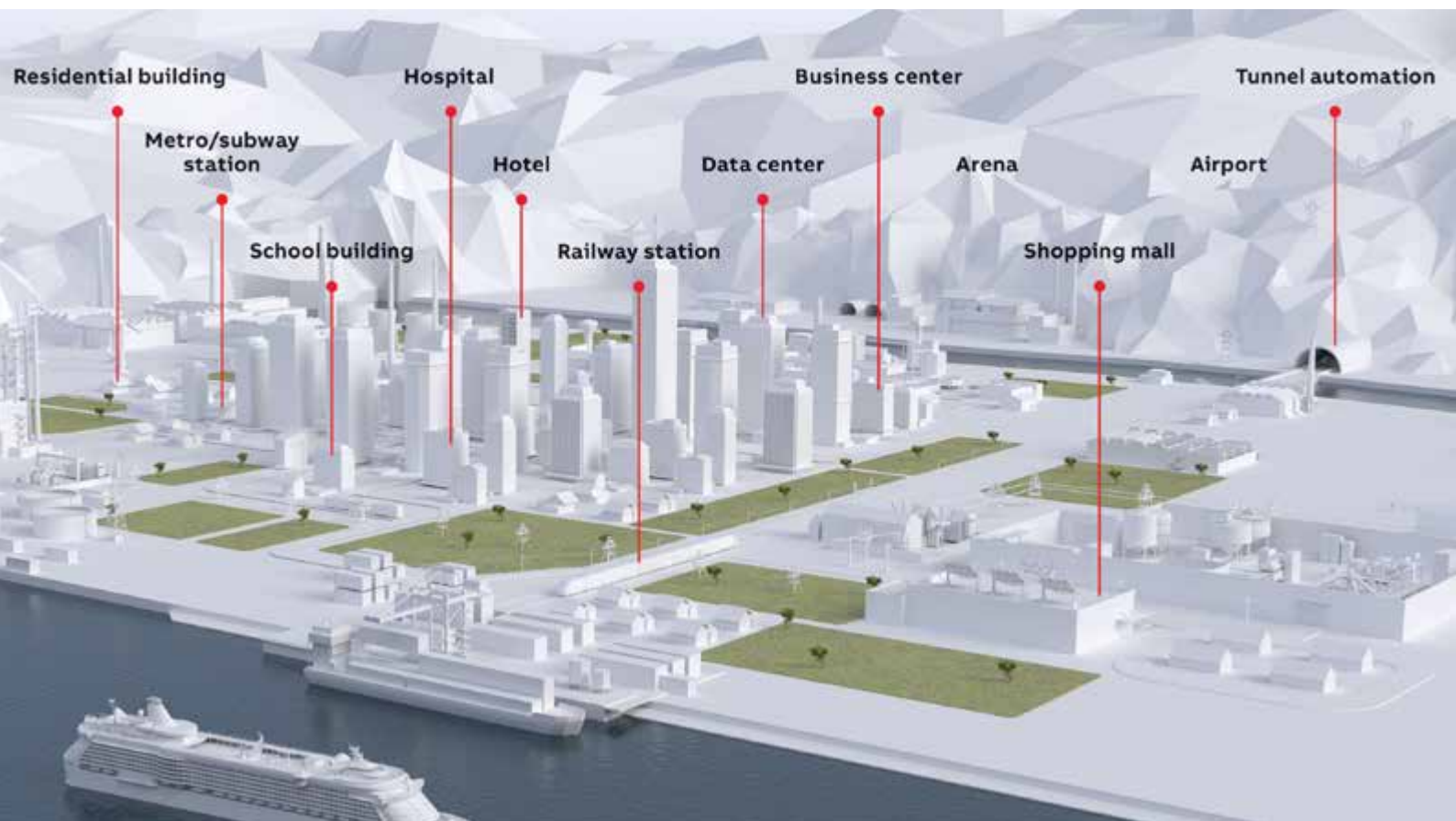

Central HVAC, room and lighting management

ABB's KNX devices can control heating, cooling and lighting systems at room and floor levels and communicate directly also with central controllers like AC500. Such an integrated system can respond e.g. to sunshine thus ensuring optimal lighting and heating in every room individually, based on detected motion or absence in rooms. CP600 control panels can display the energy consumption of the individual rooms. Local or remote display is possible. With our integral solution, substantial energy savings can be achieved making your investment more profitable.

Reliability and scalability

In critical building applications, such as data centers, hospitals, airports or railway/metro stations, reliability of the installed automation solution is key to a safe, productive and cost-efficient operation.

For example in a hospital, reliable function and uninterrupted power supply during surgery are essential for the safety of patients and their treatment. ABB's AC500 addresses these concerns by offering the required special features like multiple communications, high-availability as well as hot swap features. These features are vital to protect surgeons and patients from external impacts causing unforeseen downtime in the operation of the building automation system.

Communication and openness

AC500 as an open communication platform can connect to Building Management Systems or field devices via various protocols, increasing usability, including OPC UA, BACnet (BTL certified) and KNX protocols beneath many others.

With the proven ABB i-bus® KNX system expanded by AC500, it is possible to automate all building automation functions and combine them via BACnet into a single solution with the Building Automation System across all levels.

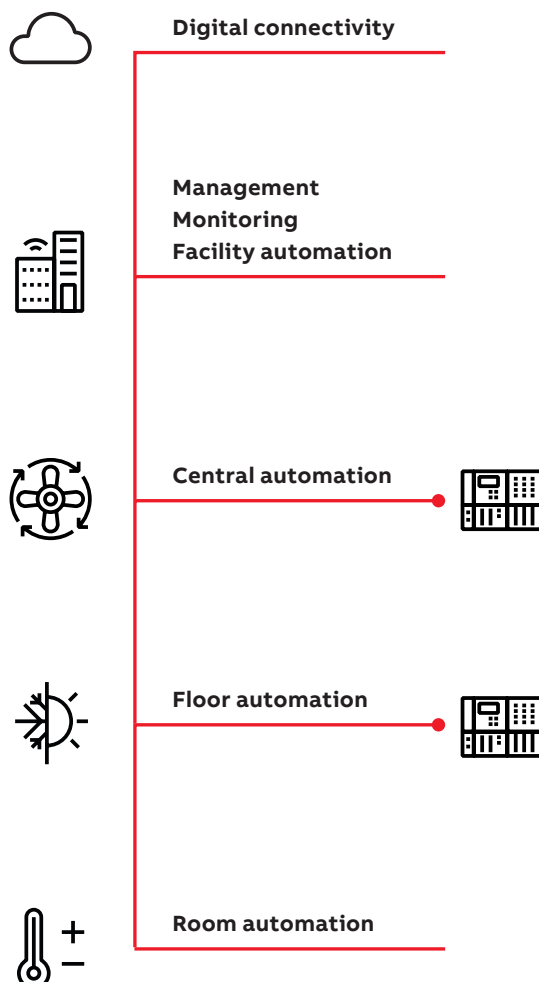

Application descriptions and features

Building automation with AC500, KNX and BACnet

AC500 as freely programmable controller, gateway or monitoring and visualization device

Use the AC500 PLC and S500 I/O for modular control e.g. for advanced energy efficient, safe and secure operation and monitoring tasks, from small to largest buildings.

Use the AC500 communication capabilities with other fieldbuses and protocols to connect, control and monitor the large portfolio of ABB components such as other low voltage products, ACS drives, motors, substations or connect them with building automation systems and the cloud e.g. with BACnet and OPC UA.

Use the AC500 and CP600 visualization capabilities for powerful local or remote monitoring across all levels.

Use KNX connectivity to add communication capabilities of the proven ABB i-bus® KNX devices like e.g. Dali, M-Bus etc. to the PLC automation level.

Everything in one system from room to central building functions, based on

- KNX and its efficient engineering by integration of ETS and ABB Ability™ Automation Builder.
- BTL certified BACnet (IP and MS/TP) with comfortable configuration in ABB Ability™ Automation Builder.

Easy creation and reuse of automation software in building automation by using the IEC 61131 standardized programming languages and library philosophies.

HVAC application

Heating, ventilation and air-conditioning technology is made up of various systems, often spread on room, floor and central levels that can now be integrated into a single system with the same integrated engineering to enable optimization across all levels.

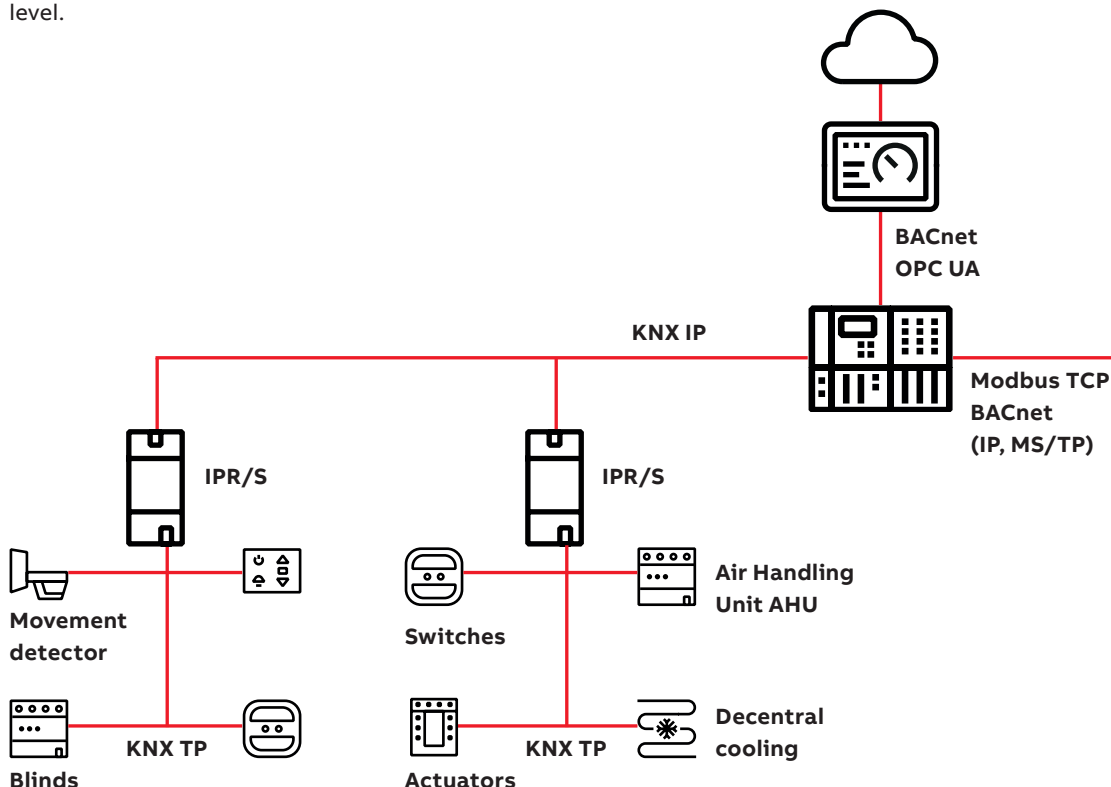

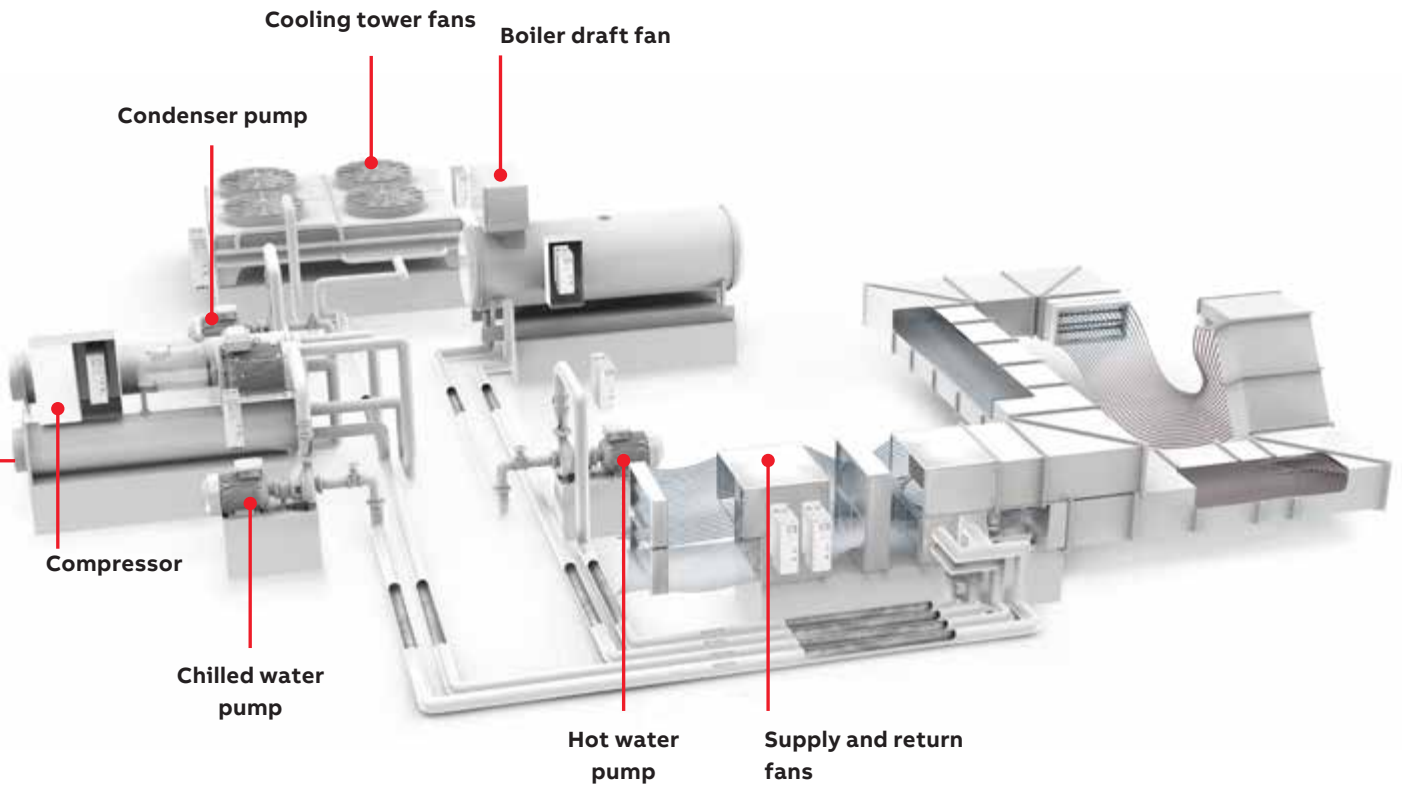
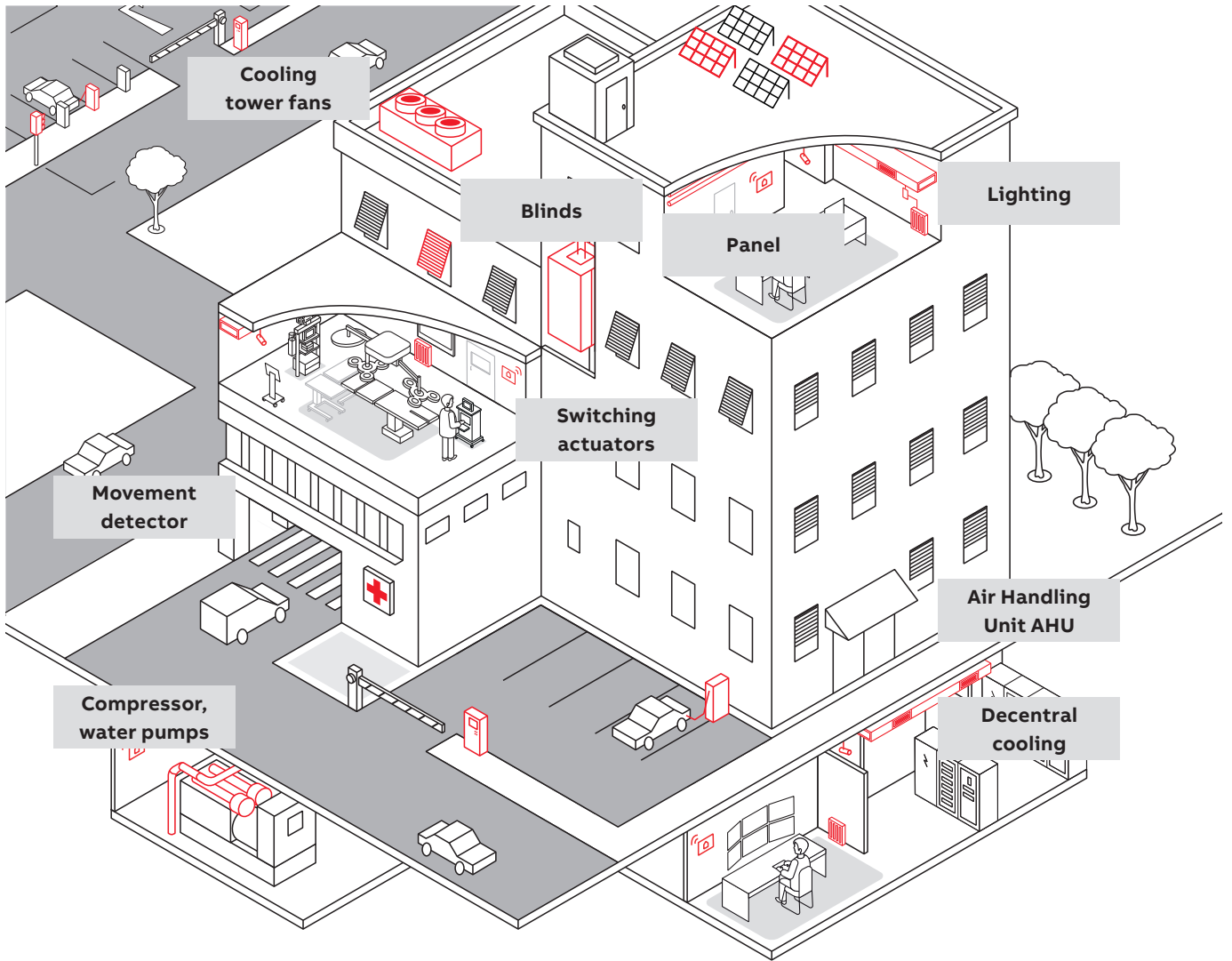

Application descriptions and features

Tunnel automation with AC500

ABB's core competence is proven by numerous tunnels globally - based on PLCs, HMIs, motors, drives and the ABB Ability™ Automation Builder integrated engineering suite. They are a perfect fit for tunnel applications, resulting in engineering productivity.

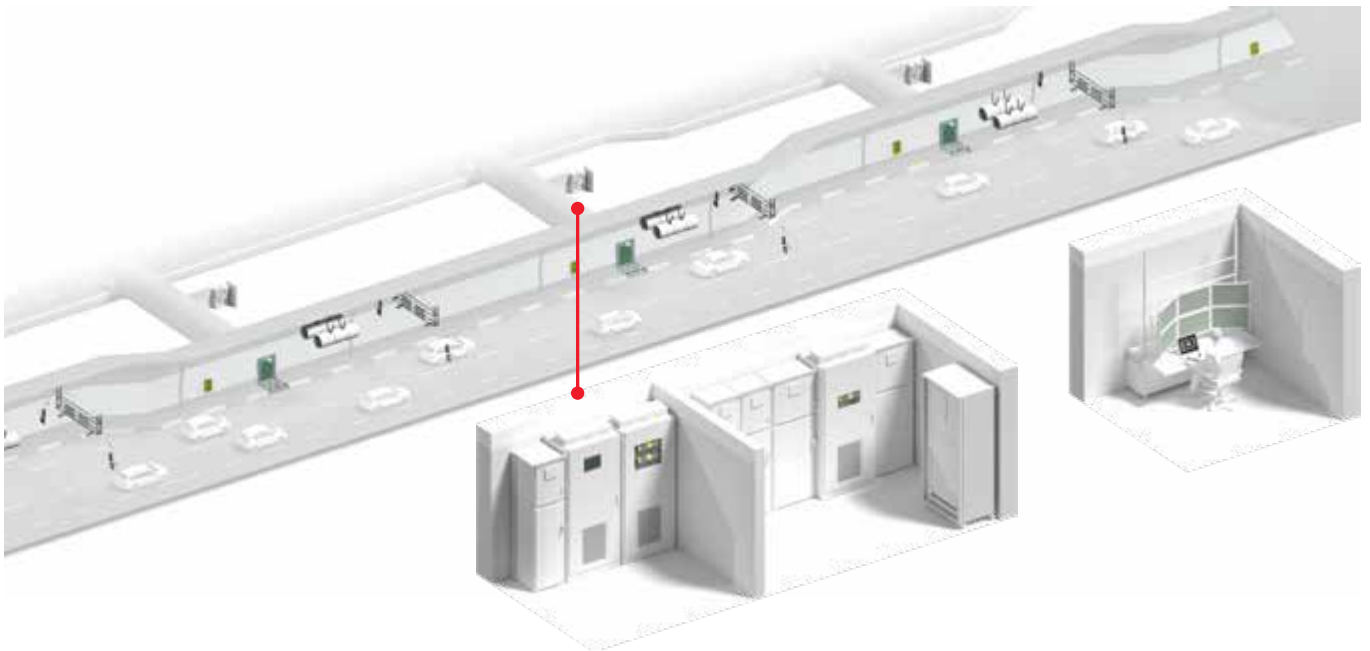

Tunnels are created wherever local conditions do not permit an efficient road or rail routes. They connect people by shortening travel times significantly, protect man and nature from noise and exhaust fumes and make remote areas accessible.

The safety standards for tunnels are regularly reviewed and adapted to the latest findings. New tunnels will be built and equipped on the basis of the most up-to-date and safe technologies and constructions, while older tunnels will have to be upgraded.

ABB offers a portfolio of higher-level control systems (SCADA) which act on top of the local ABB PLC-based architecture. All technical subsystems and field devices of the tunnel system can be controlled and monitored from one or several central locations.

ABB provides an end-to-end portfolio with a high number of scalable products and options, from the field layer right through to the management and visualization layers. This saves significant engineering time and money, while at the same time ensuring a highly available, safe and future-proof tunnel system.

Due to their scalability AC500 PLCs play a key role in tunnel automation. They can be used in all sizes of infrastructure projects ranging up to many tens of kilometers with hundreds of I/O stations distributed over the whole length of the tunnel.

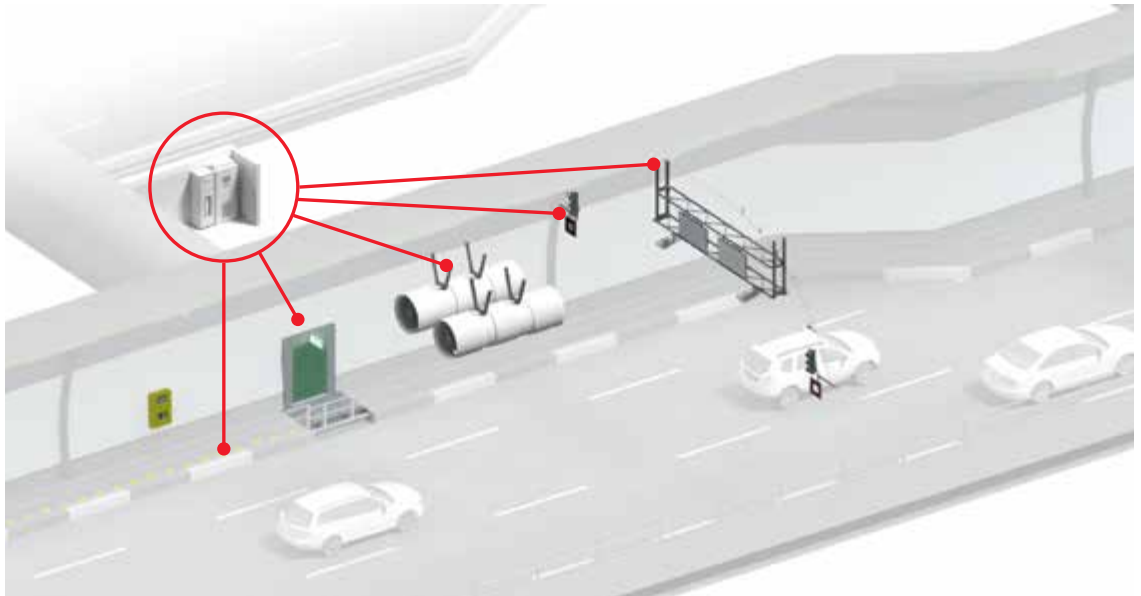

Protection and security

- Tunnel ventilation to protect people and equipment in every situation
 - Smoke extraction
 - Fresh air circulation
- Video and radar control to detect hazardous situations early
- Emergency evacuation system of the entire tunnel providing safe waiting spaces
- Modern lighting technology for safe navigation and good recognition of vehicles and passengers
- Manual call points along the exit routes
- Firefighting systems



Control and safety

- AC500
 - High availability
 - Safety PLC
- Drives for an optimal integration of the tunnel fans
- Suitable offers of control systems and switchgear
- Power monitoring
- Low-/medium-voltage distribution systems
- Emergency power supply



Communication and reporting

- Remote monitoring/IoT
- Remote maintenance
- General public announcement system
- Communication and notification system accessible from every point in the tunnel
- Optimized traffic flow with data acquisition via AC500
 - Signal systems
 - Changing traffic signs



Supervision and monitoring

- Local and higher-level control systems (SCADA)
 - Dashboards for an overview of the entire tunnel system
 - HMI CP600
- Energy management for the complete system
- Drive systems to efficiently operate tunnel ventilation

Please watch our videos on our ABB PLC YouTube channel:



youtube.com/user/abbplc

The descriptive and interactive landscape contains links to web pages, brochures, infographics and images. You can access it with your tablet or PC. Scan the QR code now to discover ABB solutions for smart societies, and to find out how AC500 supports the tunnel industry:



smartsocieties.abb.com



Application descriptions and features

AC500 HA offers hot standby redundancy

02

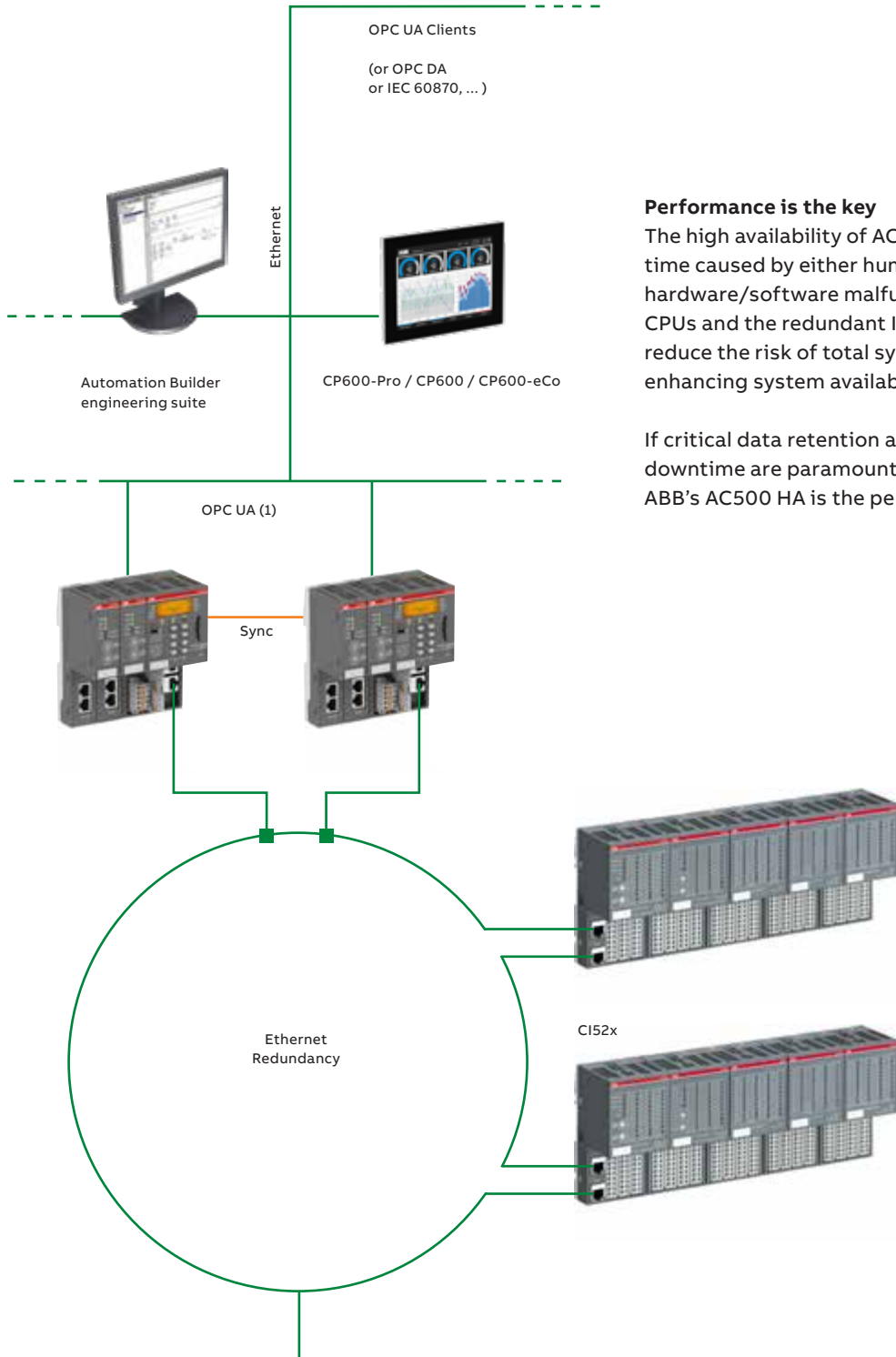

Performance is the key

The high availability of AC500 HA prevents downtime caused by either human error or cabling/hardware/software malfunction. Redundant CPUs and the redundant I/O communication reduce the risk of total system failure, thus enhancing system availability.

If critical data retention and the avoidance of downtime are paramount to your application, ABB's AC500 HA is the perfect solution.

(1) AC500 V3 CPUs only

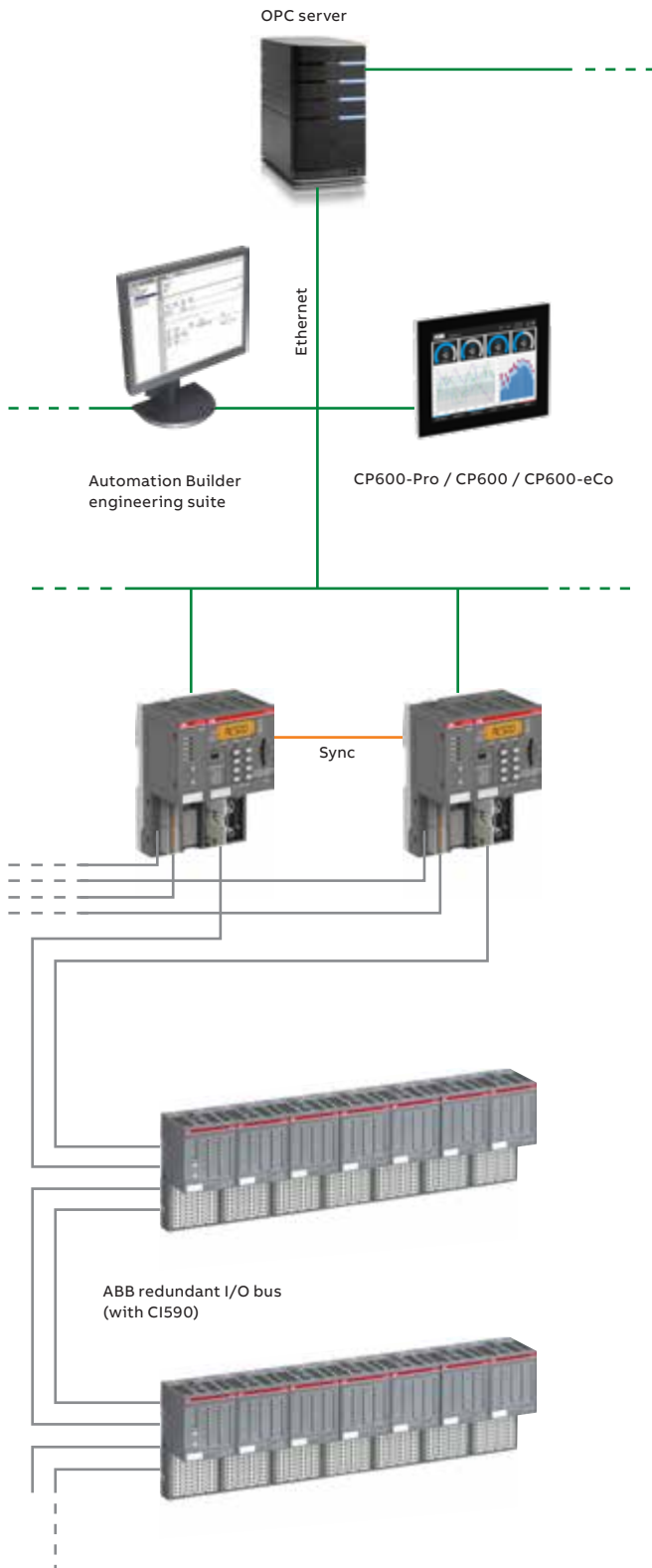

What are the benefits of AC500 HA for your high availability solution?

- Hot standby: Both CPUs (and all communications) are hot: Permanently running in parallel, continuously synchronizing each other and monitoring the system. If the primary CPU is stopped, powered off or crashed, or if an I/O communication/cable has failed, the other hot standby CPU takes over immediately by adopting primary status.
- Higher resource utilization, no downtimes caused by cabling/hardware/software failure thanks to redundant CPUs and redundant communication to I/O and SCADA/HMI.
- Cost efficiency and easy system maintenance through the use of standard hardware.
- High availability is provided with standard CPUs. Cost matching hot standby quality for small or large systems.
- Scalable in both variants: CS31 redundancy bus or Ethernet.
- Suitable for large distances between redundant CPU (10th of kilometers).

Application descriptions and features

Hot Swap of S500 I/O modules for increased availability



Replacing S500 I/O modules while the system is running

The hot swap terminal units TU516-H, TU532-H and TU542-H allow no-load hot swapping of S500 I/O modules during operation. When replacing a S500 I/O module the other modules in the cluster continue operating.

This capability is available for an I/O cluster with the following fieldbuses:

- PROFIBUS
- PROFINET
- Modbus TCP

Hot swap terminal units can also be used in I/O configurations attached to AC500 CPU modules.

Hot swap terminal units can be mixed with all normal terminal units (except safety terminal units) in the same configuration, when only specific modules need to be hot swapped.

The hot swapping feature is also available for extreme condition variants of S500.





Permanent wiring

Due to the construction of the S500 system, the wiring remains untouched during hot swap. There is no need to remove terminal blocks.

The S500 I/O module can be removed and replaced while the other modules in the configuration continue operating.

As soon as a module is re-inserted, it will be configured automatically and put into operation.

Applications

Hot swap is needed in hybrid applications when the control system must not be switched off during the replacement of a module.

Application descriptions and features

S500 I/O modules run with various controllers

S500 remote I/O

The availability of different fieldbus communication interfaces makes it easy to use S500 I/O modules as remote I/O for nearly any PLC and PC. The S500 remote I/O station consists of a communication interface and I/O modules. The smallest configuration can be just the communication interface with the onboard I/O channels.

Communication interfaces are available for the following fieldbuses:

- PROFIBUS
- PROFINET/PROFIsafe
- EtherCAT
- Modbus TCP
- CANopen
- ABB CS31 System Bus

Third-party PLCs, IPC or machine controller

Controller can also be an IPC with ABB Ability™ for data center

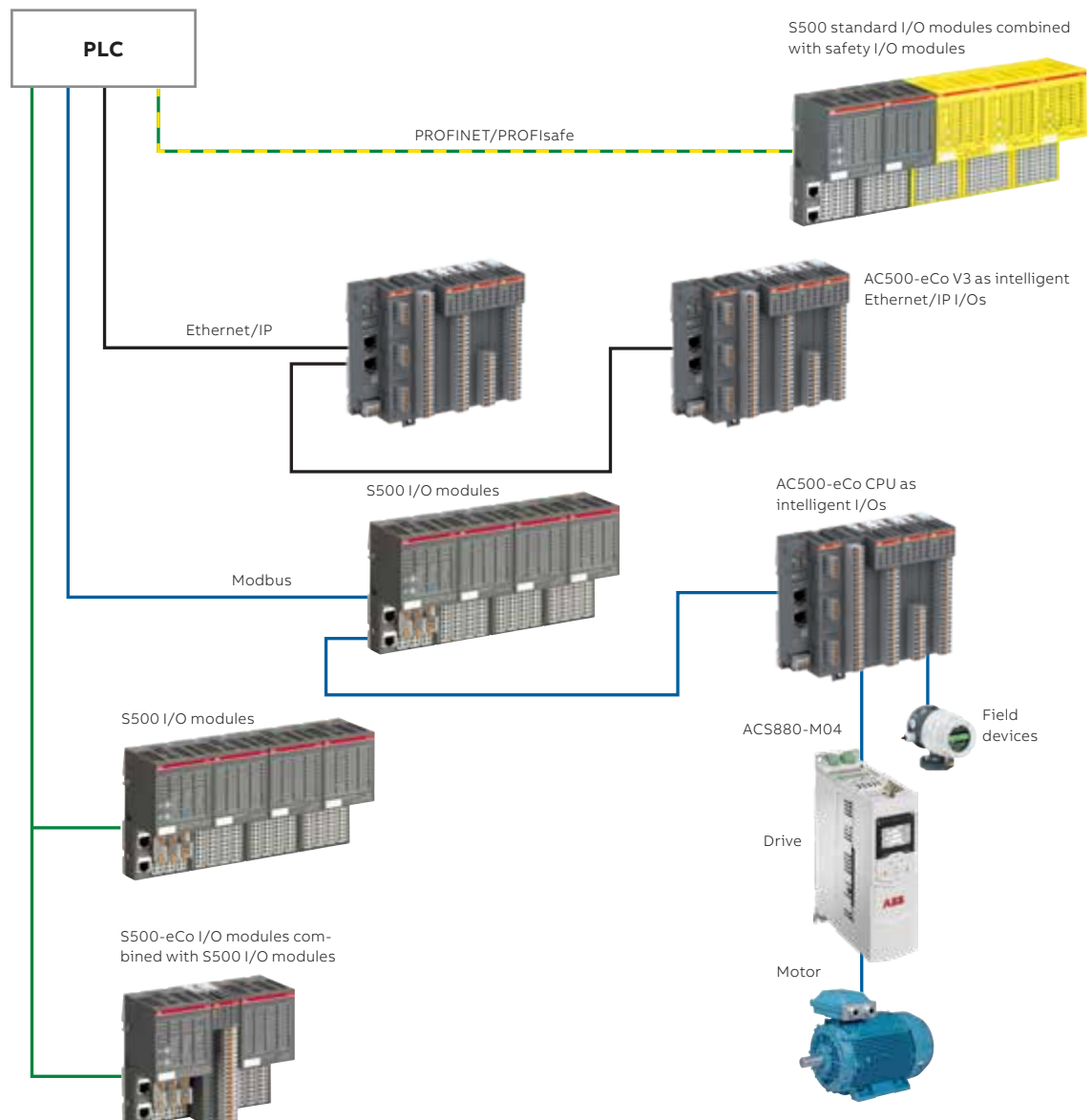

Easy engineering

The electronic configuration files that are provided by ABB for different fieldbus systems make it easy to configure the S500 remote I/O station in your engineering tool. The files such as GSD and GSDML are available for download at new.abb.com/plc. For Modbus TCP remote I/O stations a dedicated configurator is included in Automation Builder and for larger applications a Bulk Data Manager tool can be used.

AC500-eCo CPU as S500 remote I/O

When the AC500-eCo compact CPU is used as remote I/O, it can be programmed with Automation Builder for local intelligence while communicating via the open protocols Ethernet/IP, Modbus TCP or Modbus RTU with a CPU that will then be the master of this intelligent remote I/O station. The AC500-eCo CPU can be expanded by I/O modules from the S500 and S500-eCo range.

S500 remote I/O with Modbus TCP

ABB provides a configurator in the Automation Builder tool, which allows the configuration of Modbus TCP I/O stations with the communication interfaces CI521-MODTCP or CI522-MODTCP in the same style as the AC500 configuration. For larger applications a Bulk Data Manager tool can be used. The configuration can be stored in the communication interface, which allows using the configured station with any PLC or PC that supports Modbus TCP. This e.g. allows the use directly on other controllers or monitoring systems as e.g. ABB Ability™ Data Center Automation or external systems.

Thanks to the Modbus feature that allows several masters to exchange data with the same slave, it is possible to use the I/O station as shared devices with up to 10 PLC CPUs.

The Modbus masters can access the process data of the I/O stations in two different ways:

- Fixed mode: each I/O module in the station uses a separate register address range, which requires separate Modbus read/write operations for the modules in the station.
- The dynamic mode allows to pack the data of all I/O modules in the station in one data structure that can be exchanged in one single read/write operation.

S500 remote I/O with PROFINET/PROFIsafe

Simply extend your control system with ABB standard and safety I/Os to simplify wiring, reduce operating costs and benefit from the unique features of our safety I/O portfolio to increase the productivity of your machines. For more information about safety applications, please see application description Embedding safety I/Os in ABB robots on page 92.

S500 in hybrid applications with AC 800M Controller

The communication interfaces for PROFIBUS and PROFINET facilitate the integration of S500 as remote I/O stations in the System 800xA AC 800M family of controllers. System redundancy is supported with PROFINET. The configuration is integrated into the Control Builder M engineering tool. Hot swap of S500 I/O modules is possible when these are mounted on hot swap terminal units.

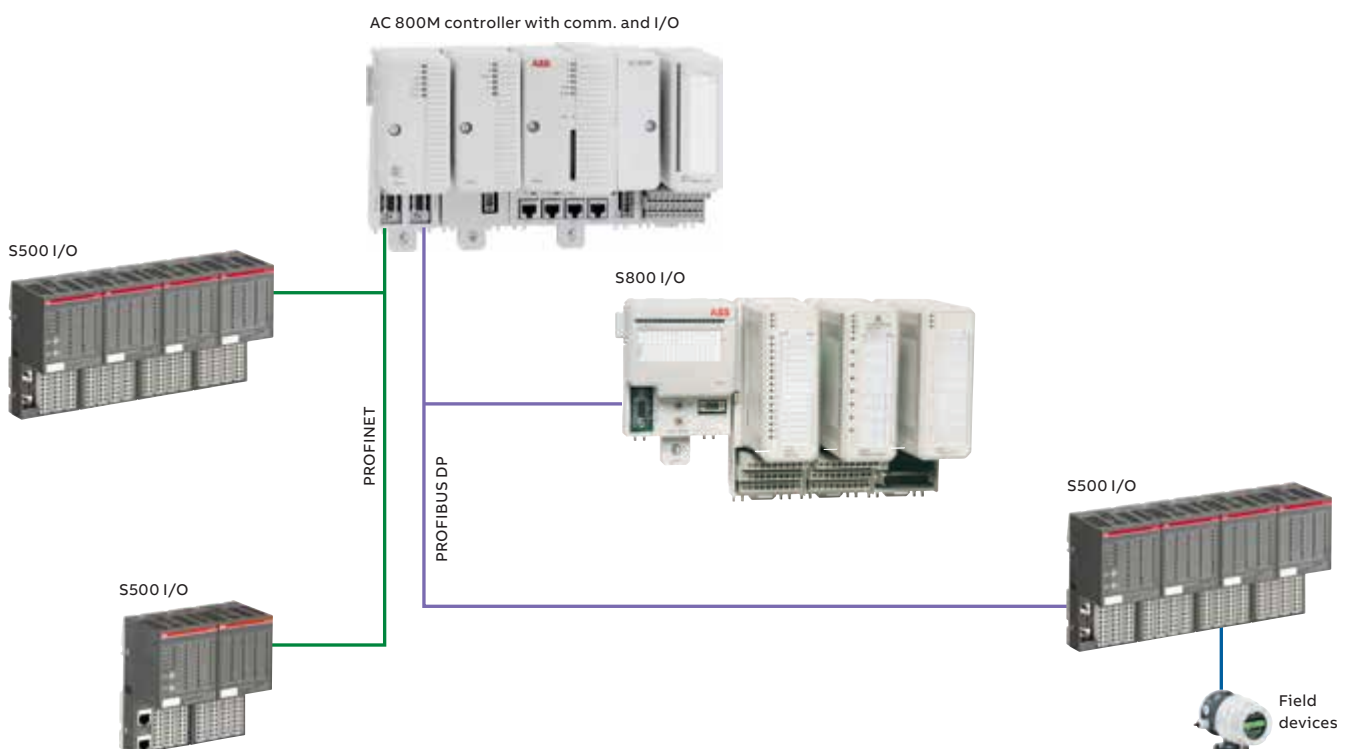

Application descriptions and features

Integration of AC500 PLC into ABB Ability™ System 800xA

Integration of AC500 PLC into System 800xA

The AC500 PLC hardware can be used for automation of process modules while the operator benefits from user experience in System 800xA. Proven libraries are provided for System 800xA and AC500. This allows programming control tasks in the AC500 PLC while System 800xA is the operator interface. For large distributed projects, many AC500 PLCs can be connected to a System 800xA node.

Process Control objects

Twelve objects are available which cover the following functionalities:

- Digital and analog setpoints
- Analog measurement with threshold alarm functions
- Valve control
- Motor control with or without variable speed drives
- Proportional integral controller

Communication between System 800xA and AC500 PLC

Communication between the AC500 function blocks and the objects in System 800xA uses the PLC Connect option of System 800xA and the AC500 OPC Server.

Simplified engineering

The Process Control Objects (PCO) library for AC500 V2 contains a function block for each object. The control task is engineered with the AC500 engineering tool ABB Ability™ Automation Builder. The communication between the objects in System 800xA and the function blocks in AC500 is configured with Bulk Data Manager, which is part of the System 800xA Engineering toolset. A library with ready-made symbols and faceplates for the objects is available for System 800xA engineering.

Integrated documentation

For engineering, the function blocks for AC500 include the user documentation. The faceplates provide multi-language support for the text elements and allow adaptation of the color codes of the elements to the preferences of the application.

Availability

Libraries containing the Process Control Objects (PCO) are available for AC500 V2 (in Automation Builder) and for AC500 V3 (in an application example for download). The Automation Builder installation also contains the required OPC server. The corresponding 800xA PLC Object Library for 800xA or Compact HMI can be ordered via the 800xA add-on features list.



System 800xA and AC500 PLC network architecture



Network

Compact HMI for local operation



CP600 HMI for local operation



Control of process in AC500 PLC

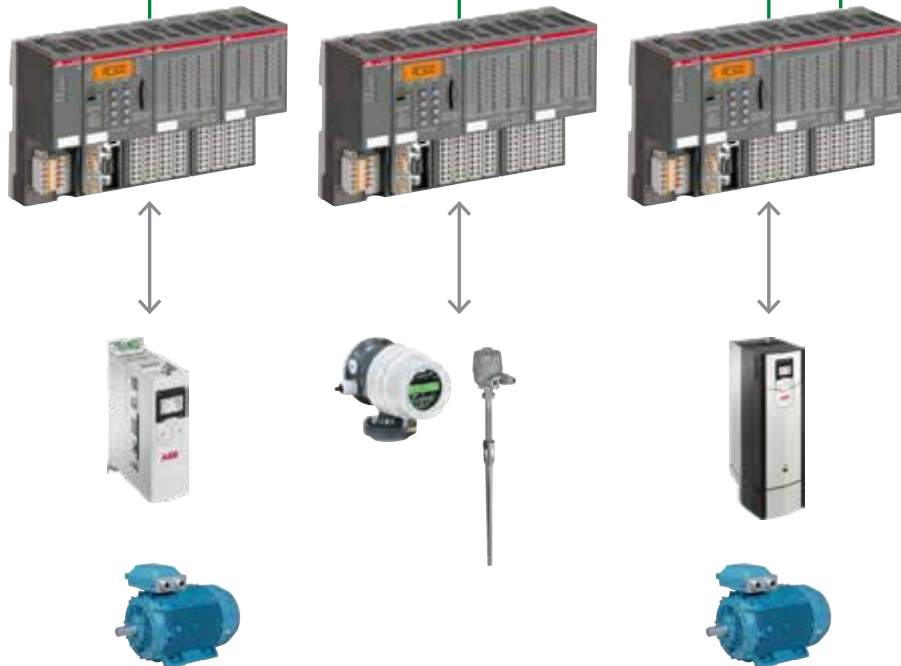

Application descriptions and features

Condition Monitoring with AC500 PLC

Controller integrated or stand-alone condition monitoring

The AC500 condition monitoring module FM502 is a natural part of the AC500 platform and ABB Ability™ Automation Builder, and can be used in different condition monitoring concepts, stand-alone or control integrated.

Due to the easy programming in PLC languages, it is usable for a variety of use cases and is especially suitable for plant, line and machine builders as easy extension of their offering.

If controller integrated

- it enables at very reasonable cost
- the best prediction horizon as it can measure online, when best measurement quality is given without scheduling production interruptions
- while continuously protecting the application in real time e.g. with the same or other sensor(s).
- Further inputs can be used as fast data logger e.g. precisely documenting process quality.

Therefore it is not only able to continually check the mechanical components but also gives fast protection for spontaneous and large failures even while measuring. The condition monitoring mode creates a database internally or externally for predictive maintenance. Automatic and user assisted responses can be enabled to prevent costly consequences including total failures.

As many as 16 vibration sensors + 2 encoder counters can be connected.

The recorded condition monitoring data can be stored in the CPU flash disk before communication or directly analyzed. Higher level indicators can be calculated and communicated to a local or remote HMI or database system.

Predictive performance for your process or machines

- Easy and cost saving integration of condition monitoring into the AC500 platform.
- Early detection of mechanical damages.
- Fast protection from spontaneous failures.
- Even complex C-code analytics can be used locally for meaningful own performance indicators.
- Leads to optimized planning of maintenance instead of fixed, scheduled service and spontaneous repair.
- No additional system or fixed software for diagnostics and visualization needed.
- Easy storage of the data, locally (4GB) or in remote servers and databases.
- Ideally suited also for retrofit of older equipment, as it can make use of mechanical reserves of still valuable equipment.



AC500 Condition Monitoring module
FM502-CMS: Controller integrated or stand-alone CMS covering a complete drive train.

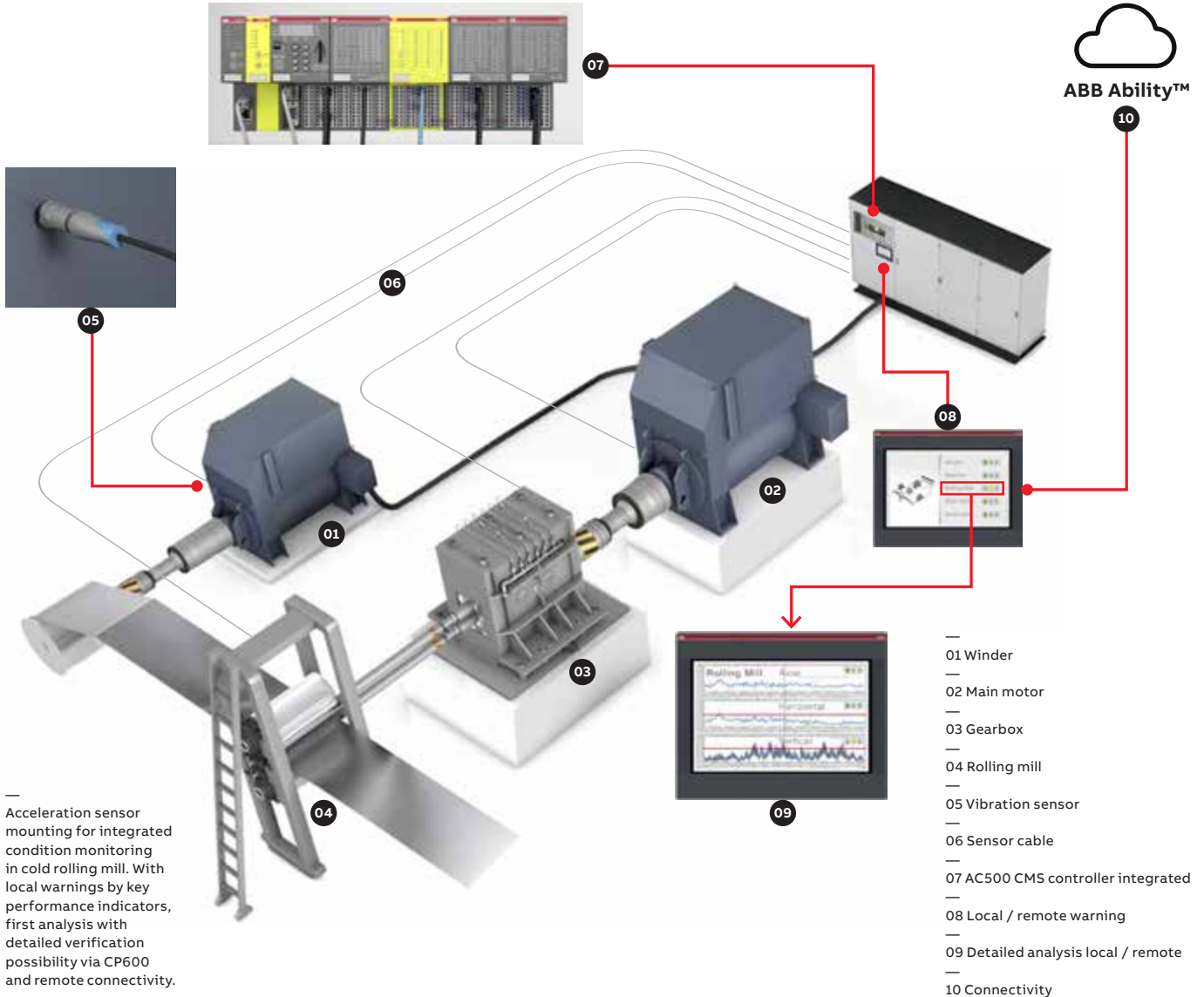
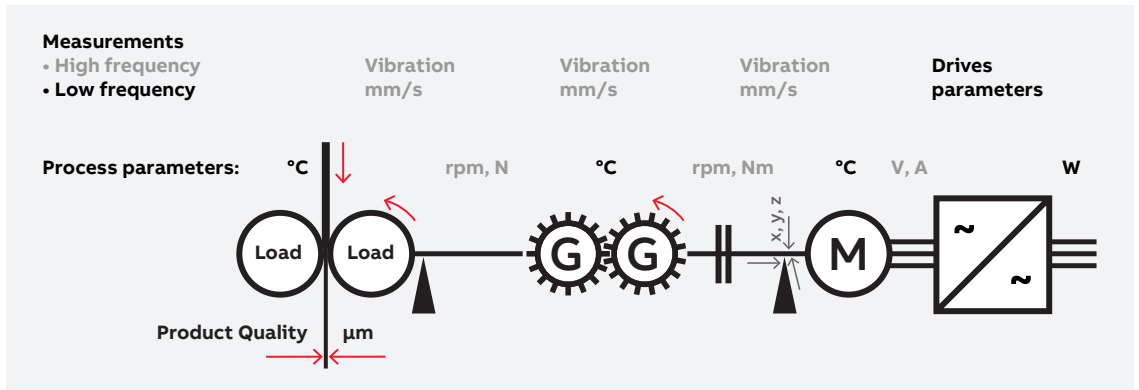

Acceleration sensor mounting for integrated condition monitoring in cold rolling mill. With local warnings by key performance indicators, first analysis with detailed verification possibility via CP600 and remote connectivity.

Example: Cold rolling mill in steel processing:

- One FM502-CMS module can execute differently configured measurements at the same time and can be reconfigured at runtime.
- Several critical and unique components can be protected and condition predicted: Motors, gearbox, process (cold rolling mill).
- Production quality can be logged in parallel in real time.
- Remote diagnostics expertise and detailed analysis and reports only in case of warnings.

Please watch our videos on our ABB PLC YouTube channel:



youtube.com/user/abbplc

Application descriptions and features

Machine controllers based on AC500 PLC

From simple to high end motion applications

- Convenient PLC portfolio for diverse applications
 - Simple machine control with AC500-eCo PLC
 - Point-to-point motion with PTO outputs or Modbus communication with the drive and AC500-eCo V3
 - Mid-range applications with AC500 PLC
 - EtherCAT communication with the drive or remote I/O and cam-switch for synchronized motion
 - High-end motion application with PM595
 - Axis interpolation e.g. for Delta robot
- Easy integration and excellent scalability using ABB Ability™ Automation Builder
- Motion wizard and library for fast setup of complex applications

Multi-axis motion coordination with EtherCAT

ABB's AC500 PLC using EtherCAT real-time bus delivers high performance for multi-axis control applications.

The AC500 PLC provides an industry solution with IEC 61131-3 programming and PLCopen motion functions in combination with ABB drives such as ACS880-M04 fitted with the FECA-01 EtherCAT module for higher power axes or ACS380 drives or MicroFlex e180/e190 drives.

This popular high-performance motion bus provides simple 'daisy chain' connection.

- EtherCAT multi-axis coordinated motion
- 01 AC500-eCo V3 PLC Onboard EtherCAT – in preparation
- 02 AC500 PLC
- 03 CP600 HMI
- 04 Pluto Safety PLC module
- 05 MicroFlex e190
- 06 MotiFlex e180
- 07 ACS880-M04
- 08 ACS380
- 09 ACS880
- 10 S500 EtherCAT I/O
- 11 Third party CAN device

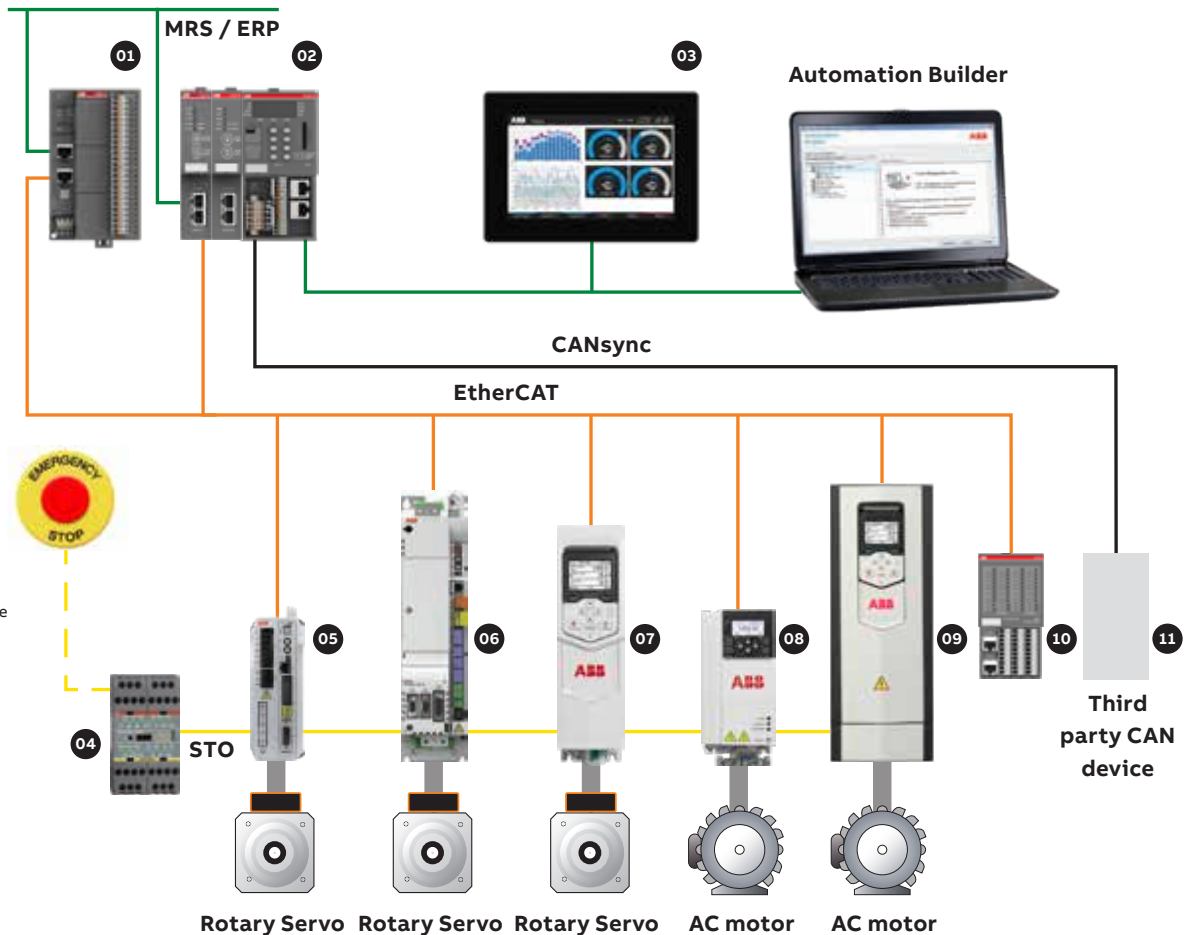

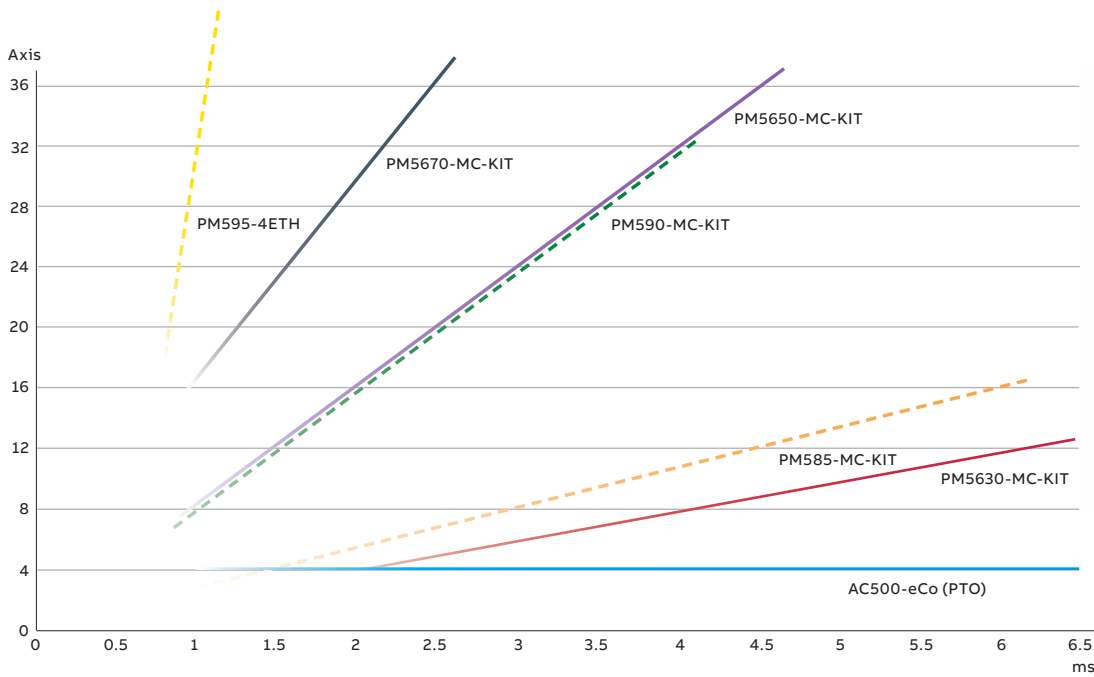

—
01 Number synchronized
Axes / ms

EtherCAT AC500 machine controller kits

In order to simplify your application, ABB offers products for the implementation of machine control or motion control applications. These products can be purchased individually or as a kit. Two available EtherCAT kits contain the components required for your application.

Depending on the required performance, the kit provides a powerful CPU, an EtherCAT master communication module and the respective terminal base. The kit can be expanded using standard I/Os, other communication products or software solutions.

Pulse-train based AC500-eCo motion control via PTO

Efficient and economic motion control via 4 PTO/PWM outputs usable with simple motion library or comfortable to configure PLCopen based motion control programming.

PLC Type used: AC500-eCo V3 AC500	PM5032	PM5052	PM5072	V3 PM5630	V3 PM5650	V3 PM5670	V2 PM585	V2 PM590	V2 PM595
Min. task cycle settable in ms	5	2	1	1	1	0.5	1	1	1
ETH ports	1	1	2	2	2	2	1	1	4
Option slots	2	3	3	-	-	-	-	-	-
PTO axis (200 kHz)	4	4	4	-	-	-	-	-	-
EtherCAT axis: configuration limits - performance indication: axis/ms	-	-	-	2	8	16	3	8	24
Examples:									
Number of synchr. axis in 1 ms	-	-	-	-	8	16	-	8	24
Number of synchr. axis in 2 ms	-	-	-	4	16	32	6	16	48
Number of synchr. axis in 4 ms	-	-	-	8	32	64	12	32	96
Min. EtherCAT master cycle time usable in ms	-	-	-	2	1	0.5 (1)	1	1	0.5

(1) only 2 axis at 0.5 ms

Application descriptions and features

Real-time Ethernet functionality

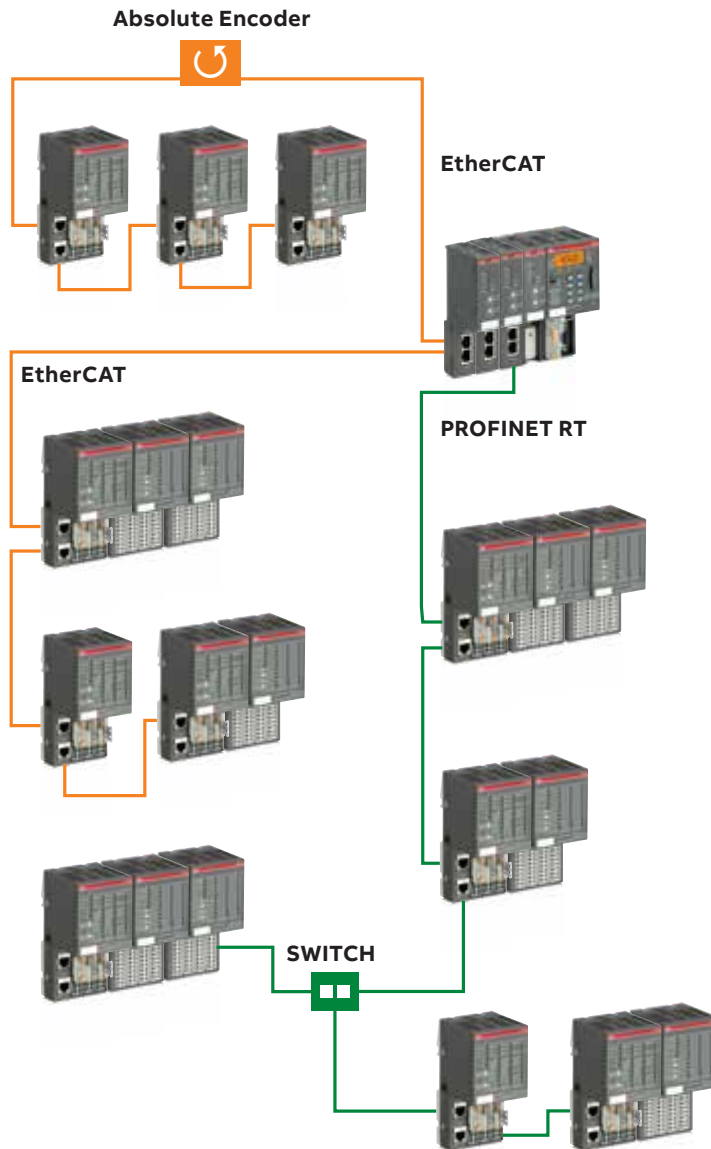

RT-Ethernet modules

Modules are available with two different communication protocols based on Ethernet (PROFINET IO, EtherCAT). Master couplers connect AC500 CPUs to remote I/O modules. Various interface modules offer the connection of decentralized I/O modules to the real-time Ethernet networks.

Cam-switch functionality

Modules based on the decentralized real-time EtherCAT interface technology with integrated I/Os and programmed with PLCopen function blocks are available.

Application descriptions and features

AC500 as advanced RTU controller



[AC500 cloud demo](#)



Advantages of AC500 as RTU

AC500's open system architecture adds value to your applications: In addition to general logic capacity, it offers advanced pre-calculation and communication possibilities. AC500 CPUs and I/O modules fulfill requirements and offer features that are requested in industries where RTU units are used.

As an open communication platform, AC500 is compatible with IEC 60870-5-104, DNP3 (1), IEC 61850, OPC UA, MQTT and Modbus TCP. Furthermore, Ethernet protocols based on TCP/IP and UDP can be developed by the user. Protocols such as Modbus RTU, ASCII, PROFIBUS and PROFINET, among others, can be used for connection to devices and actuators.

Applications and segments

AC500 has often been named the PLC of choice in the machinery, infrastructure and process industries.

(1) In preparation

Programming and configuration

The Ability™ Automation Builder is the one and only tool for programming, configuring and communication.



One tool for the complete PLC Automation product family



IEC 61131-3 compliant



Six programming languages incl. C and C++ for solving complex tasks



A comprehensive set of ready-to-use libraries for time efficiency



Machine safety standards up to SIL3 or PL e can be combined to form an integrated safety solution

Easy to handle with intuitive tools

➤ ⚡ Low-cost and power consumption, small footprint



Hot swap, network redundancy



Gateway functionality with telecontrol protocol



Versions for extended operating temperature from -40 °C up to +70 °C



Data collector and concentrator
Data logging and data storage



MQTT cloud connectivity



HTML5 integrated WEB interface



Communication capability
Modbus, IEC 60870-5-104,
IEC 61850, OPC UA and more



Cryptographic tools and security functionalities

Application descriptions and features

Safer, greener and more productive with AC500-S safety PLC

PLCs with in-built functional safety and fail-safe condition monitoring are the unsung heroes of many renewable installations like wind turbines, electric battery-operated AGVs and hydrogen tank stations.

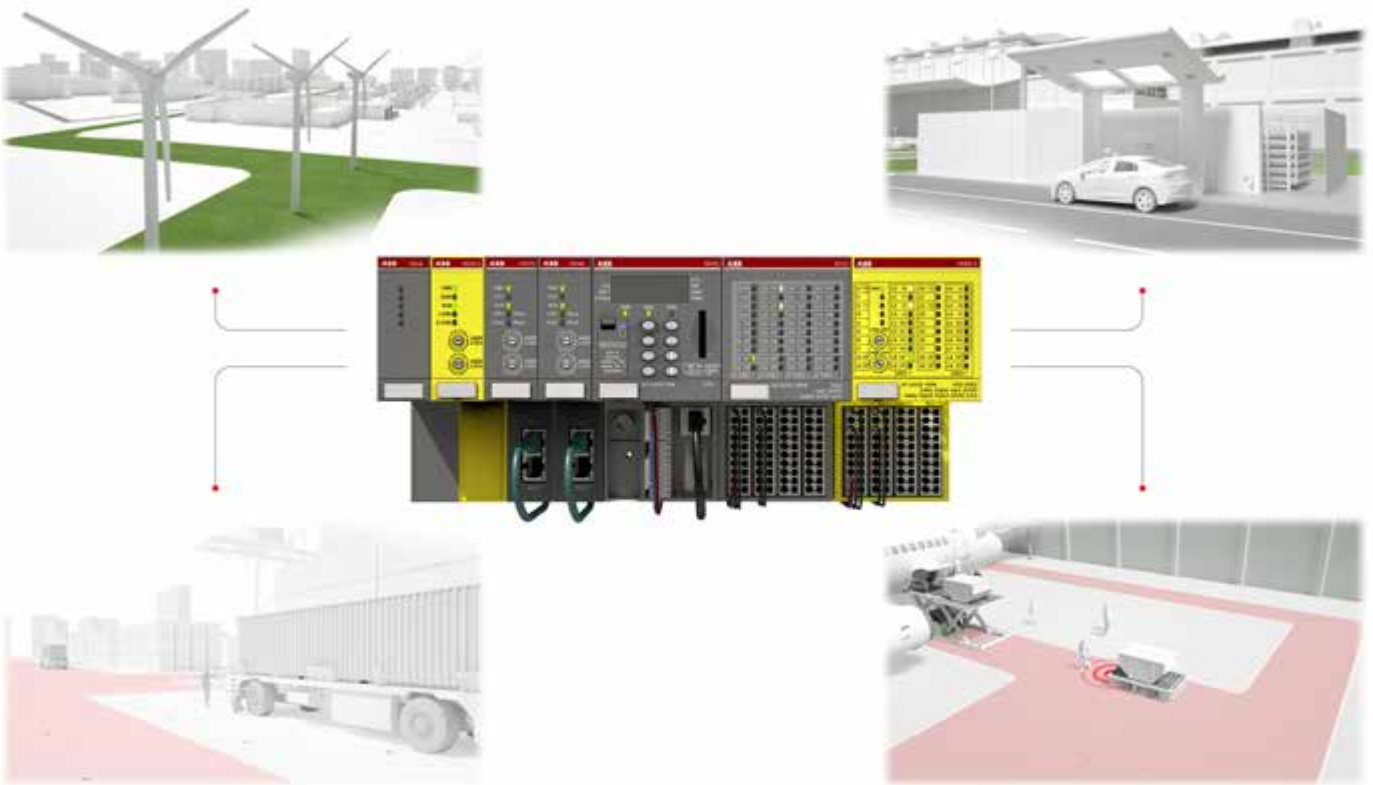

A safety PLC plays an important role in renewable energy applications

Using programmable logic controllers (PLCs) to control wind turbines or direct solar arrays has been a common solution for many years. What is not yet fully appreciated is the failsafe condition monitoring and advanced functional safety capabilities built within today's PLCs and how they can be applied to renewable applications. Not everyone has grasped the importance that functional safety plays in renewable energy applications and the influential role that a safety PLC can play.

Renewable applications often require complex safety calculations driven by the need to process vast amounts of information to safely supervise the permissible range for temperature, pressure, charge rate, vibration level or position and speed tracking in real-time. Simultaneously, there is a need to safely monitor these complex renewable processes and/or machine characteristics. Ideally placed for this are safety PLCs, with support for trigonometric functions, floating-point calculations, PROFINET/PROFIsafe communication and structured text (ST) for safety programming.

Wind turbines

Wind turbine safety is becoming increasingly important. In many countries, regulations stipulate that safety during wind turbine operation is critical to prevent accidents due to potential wind turbine collapse.

In addition to a state-of-the-art wind turbine safe control, the ABB AC500-S safety PLC with condition monitoring provides fail-safe condition monitoring of vibrations within the turbine's tower. This enables advanced safety functions to be implemented within wind turbines to avoid structural damage which could lead to accidents.

Automated guided vehicles

Airports and harbors are becoming the epitome of green design, with shore-based wind turbines powering, for instance, the charging stations used to replenish electric battery-operated automated guided vehicles (AGVs) transporting goods.

The safety PLCs can restrict battery-operated AGVs to designated areas creating safe zones where workers can move about freely. Unable to enter these restricted areas, safety barriers no longer need to be able to withstand the full-force of an AGV, leading to a more open collaborative environment. In areas where the two must mix, the PLC can take input from the AGV's laser-scanner to safely stop the vehicle if it detects a worker or other object in its path.

The safety PLC provides floating-point calculations and trigonometric functions to implement even the most complex mathematical calculations in real-time. These include safely monitoring restricted safety areas for battery-operated AGVs and collision detection.

Hydrogen tanks

To go further afield, people are increasingly turning to hydrogen fuelled vehicles to provide easy long-distance travel with much lower emissions than with conventional fuel like gasoline, gas, etc. Hydrogen is seen as an alternative to electric vehicles, featuring smaller batteries and generators, yet able to be used for longer distances. The key to this ease is the speed at which a vehicle can refill its tanks with this zero-emission fuel.

Critical to the safe operation of a hydrogen fuel tank is the need to precisely control the pressure and temperature. The tanks are packed with sensors monitoring these parameters and the PLCs provide fast processing speed to handle the large range of pressure and temperature calculations including safety functions like hydrogen leak detection, smoke detection, high pressure protection of inlet and outlet, etc. The fuelling stations use safety PLCs to precisely monitor the pressure, temperature and tank integrity, whilst providing controlled shut off of the safety valves in the event of a problem.

Please watch our videos on our ABB PLC YouTube channel:



youtube.com/user/abbplc



solutions.abb/ebrochure-smart-safety-for-material-handling

Application descriptions and features

Embedding safety I/Os in ABB robots enhances man-machine collaboration

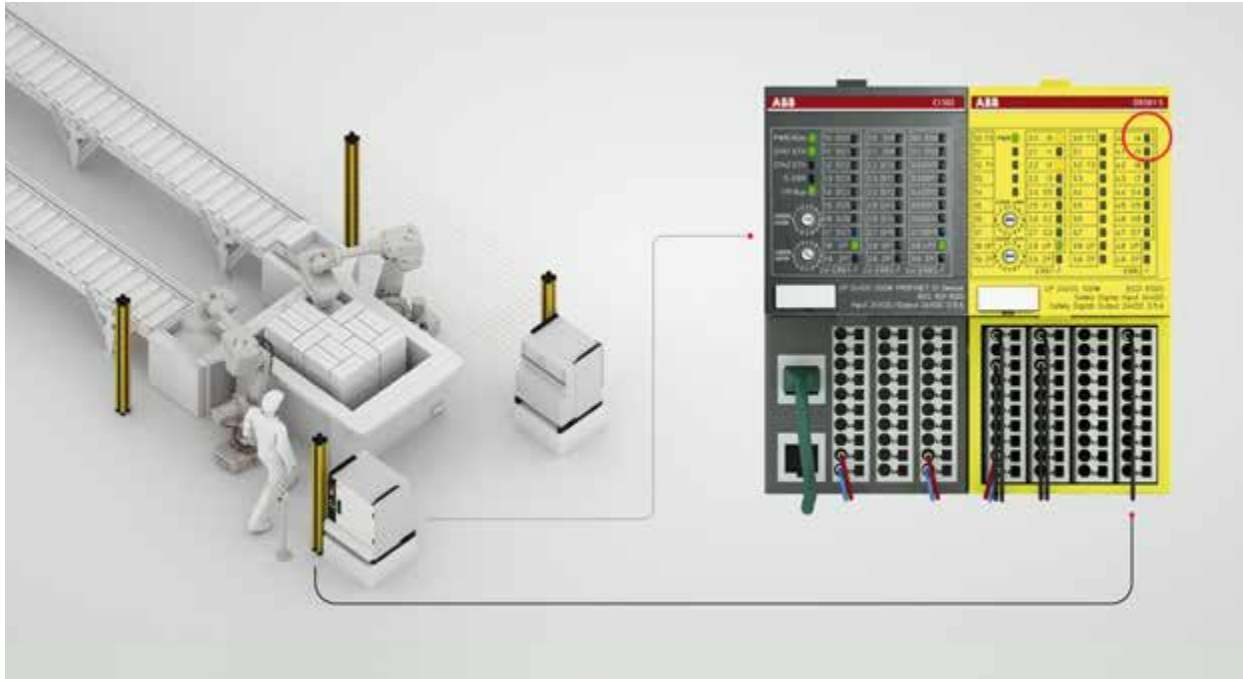

Integration of safety I/Os

ABB is embedding S500 safety I/Os within its series of robot controllers to improve the flexibility, safety and reliability of collaboration between robots and people, which prevents unnecessary disruption to production. Simply extend your control system with ABB S500 safety I/Os to save wiring efforts, operation costs and use unique features of our safety I/O portfolio to increase your machine productivity.

A light curtain, laser scanner, safety mat, E-stop and acknowledge button, for example, are connected to ABB's S500 safety I/O module, which is integral to the ABB robot controller. Should a human enter the robot's cell to undertake maintenance, the safely-limited speed of the robot can be triggered, if permitted, as opposed to a safe stop. The robot moves very slowly and within

the pre-defined safe work zone using ABB's SafeMove2. Once the human leaves the cell, the robot can resume its faster operational speed with or without acknowledgement, depending on the used safety sensors.

Cost-efficient solution

As the S500 safety I/Os are controlled by the safety module inside the robot controller, there is no need for third party stand-alone safety PLCs to be used. This saves costs as the combination of I/O and robot controller frees up space that would normally be needed for a separate cabinet. It also reduces the time associated with the set-up and operation of robotic production cells. This standardized solution leads to reduced spares, less wiring and lower operational costs as well as easy engineering through common diagnostics.

Enhanced functionality

- More test pulse outputs on S500 safety digital I/O modules ensure higher degree of fault diagnostics and reaction, which results in higher safety integrity level for safety functions in the machine.
- Each safety I/O channel has not only process state LED but also fault-diagnostic LED which significantly simplifies maintenance work and, thus, save your operation costs.
- Extreme condition (XC) modules are available (-40 to +70 °C, high vibration and shock requirements, etc.), which allows cost-savings in engineering and operation.
- Fool-proof protection implemented in all safety I/O modules (reverse signal or power supply polarity, wrong module placement, short circuit etc.), to avoid damaged modules due to wrong wiring.

More flexibility

- A single safety I/O channel can be individually reintegrated, which may provide higher machine availability in many customer cases.
- Front panel rotary switch for PROFIsafe address ensures less maintenance effort because you can see all pre-set PROFIsafe addresses directly looking at the front cover of safety I/O modules (no more need to disassemble safety I/Os).
- Built-in module power supply (no additional 24V DC power supply needed), which makes your power supply connections much simpler.

Please watch our videos on our ABB PLC YouTube channel:



youtube.com/user/abbplc



Application descriptions and features

Safe communication between safety CPUs using PROFINET/PROFIsafe over 5G

— 01 A modern distribution center comprises several independent systems including conveyor and lift systems, robotic sorting and palletizing processes, together with autonomous guided vehicles, or AGVs, and automated stacker cranes that lift pallets to and from the high bay storage systems. Each system needs to exchange its control and safety data via a central control system or distributed control system in an efficient and reliable manner so as to maintain productivity and minimize downtime.

Real-time exchange of high volume process and safety data

ABB has moved from using just one central PLC controller to multiple controllers capable of communicating with many machines in real-time. Now each machine controller can exchange big volumes of process and safety data in real-time to more than one central control system simultaneously. 5G networks can also be used to wirelessly deliver time-critical data using PROFINET/PROFIsafe.

Safety CPU modules SM560-S-FD-1 (-XC) and SM560-S-FD-4 (-XC) can function as both a safety controller and a safety device. The modules, when used with ABB's AC500/AC500-S Programmable Logic Controller (PLC), feature the ability to exchange process and safety data, not only from one controller to multiple devices but also from one device to multiple controllers, using PROFINET/PROFIsafe shared device functionality.

Now hybrid interconnected PLC control systems can extend traditional centralized or distributed control. As such, each controlled machine can deliver high volumes of process and safety data in real-time, simultaneously, to several central control systems.

This solution replaces gateways which are expensive, take valuable control cabinet space and because they are limited to only 12 bytes of safety data per gateway, cannot communicate in real-time with large safety data volumes. With the new solution, a maximum of 1440 bytes of process data including up to 384 bytes of functional safety data can be allocated for up to four PLC controller systems, thereby providing faster reaction to optimize the production and improve the predictive maintenance that leads to less downtime.

— 01

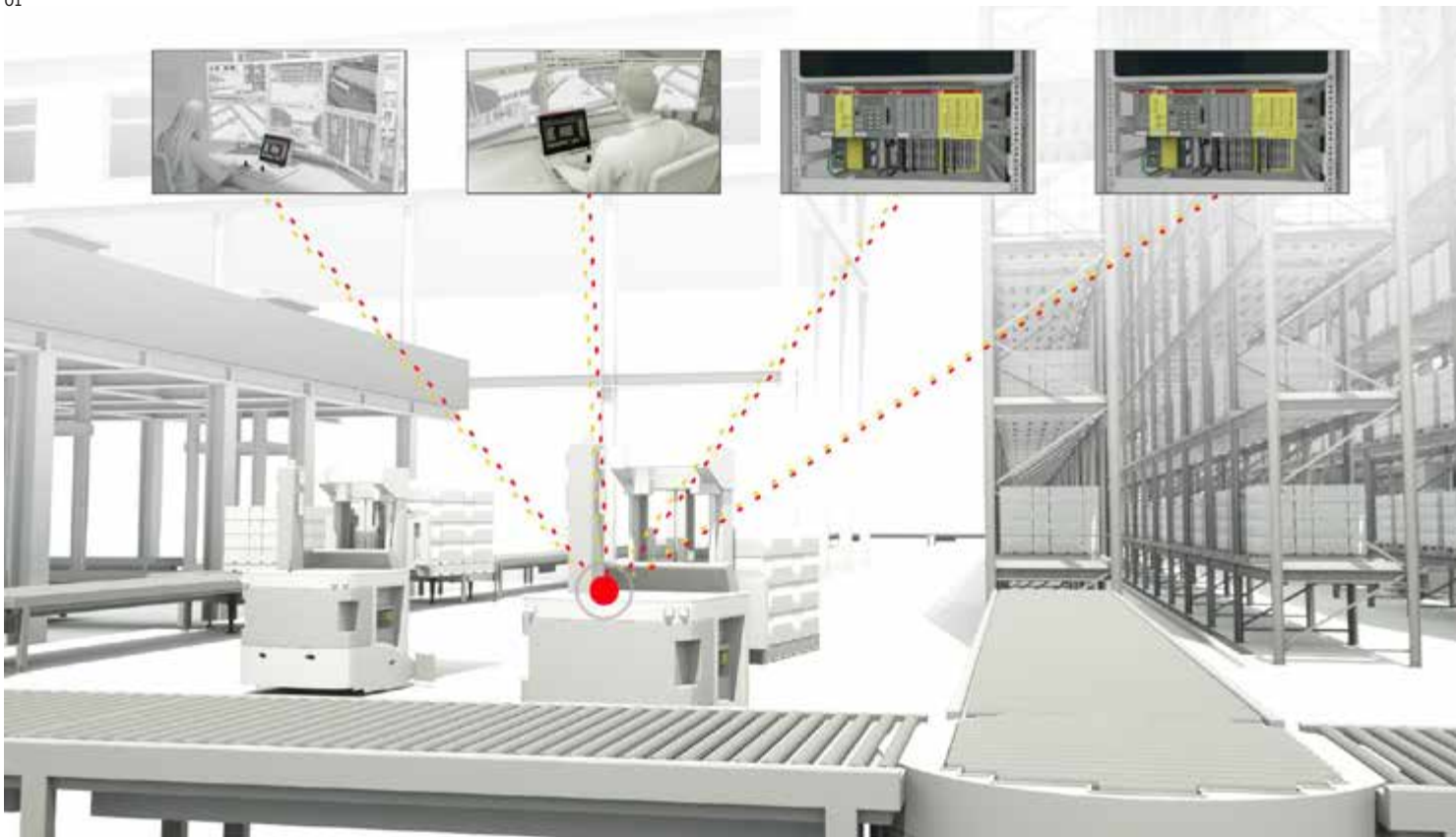

PROFINET/PROFIsafe communication between multiple AC500 PLC controllers

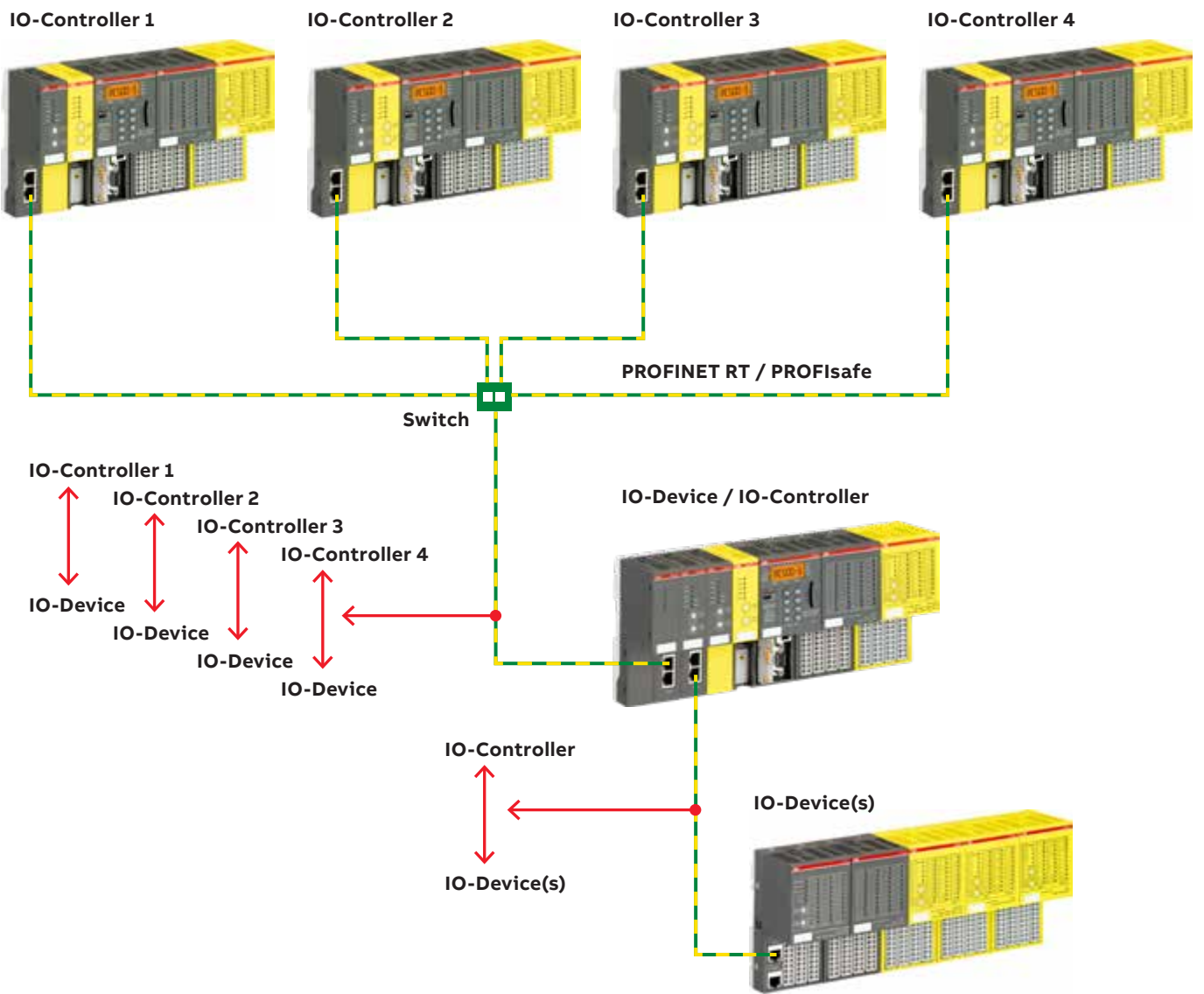

Please watch our videos on our ABB PLC YouTube channel:



youtube.com/user/abbplc

Application descriptions and features

Triggering safety actions using standard HMI

With ABB's AC500-S safety PLC, standard HMIs such as control panels and mobile devices can be used to alter functional safety control functions in industrial applications. ABB has developed a method of using standard human machine interface (HMI) products such as control panels, industrial PCs and mobile devices to reconfigure safety control functions.

Using ABB's AC500-S safety PLC, operators of equipment such as harbor and factory cranes, hoists, elevators, airport passenger bridges, automatic guided vehicles (AGVs), robots, mining and pulp & paper machinery can select, modify and amend their safety control functions. This allows them to achieve functional safety standard requirements while benefiting from the convenience and low costs of using standard HMIs.

Operators of these industrial applications need to reconfigure their safety control functions to adapt to changed application conditions and to optimize machine productivity. These reconfigurations, known as safety actions, are often performed using mechanical or electro-mechanical mode selector switches connected to the digital safety inputs of a safety PLC.

This method suffers from limited user-friendliness, inability to make modifications to switch layout and function, limited number of selection options and relatively high costs for the mode selector switches and digital safety input channels.

ABB solves these challenges by allowing standard HMIs, such as control panels, industrial PCs and mobile devices to interface with an ABB AC500-S safety PLC to carry out these safety actions.





Please watch our videos on our ABB PLC YouTube channel:



youtube.com/user/abbplc

Another example is in the selection of a crane, allowing it to be controlled remotely using the emergency stop located on the operator desk. A network links the AC500-S safety PLC in the control room with the safety PLCs at the cranes. The user in the control room can select, using standard HMI equipment, which of the cranes will stop if the emergency stop button is activated on the remote operator control station. Pressing the remote emergency stop button on the

operator's desk will therefore stop the selected crane only. Independent of the remote emergency stop function, all cranes still have their own local emergency stop controls.

The ability to select from a wide range of HMI products offers the user independence from any one vendor, a larger range of input options and greater flexibility to adapt the connections and layout of the HMIs.



ABB Ability™

Automation Builder

Integrated
engineering suite

101	Key features
102–103	Ordering data
104–105	Software features
106–107	Library features
108–109	Runtime license features
110	Productivity features
111	Advanced simulation support
112–113	AC500 for general motion control

Download ABB Ability™ Automation Builder from new.abb.com/automationbuilder



ABB Ability™ Automation Builder

Key features

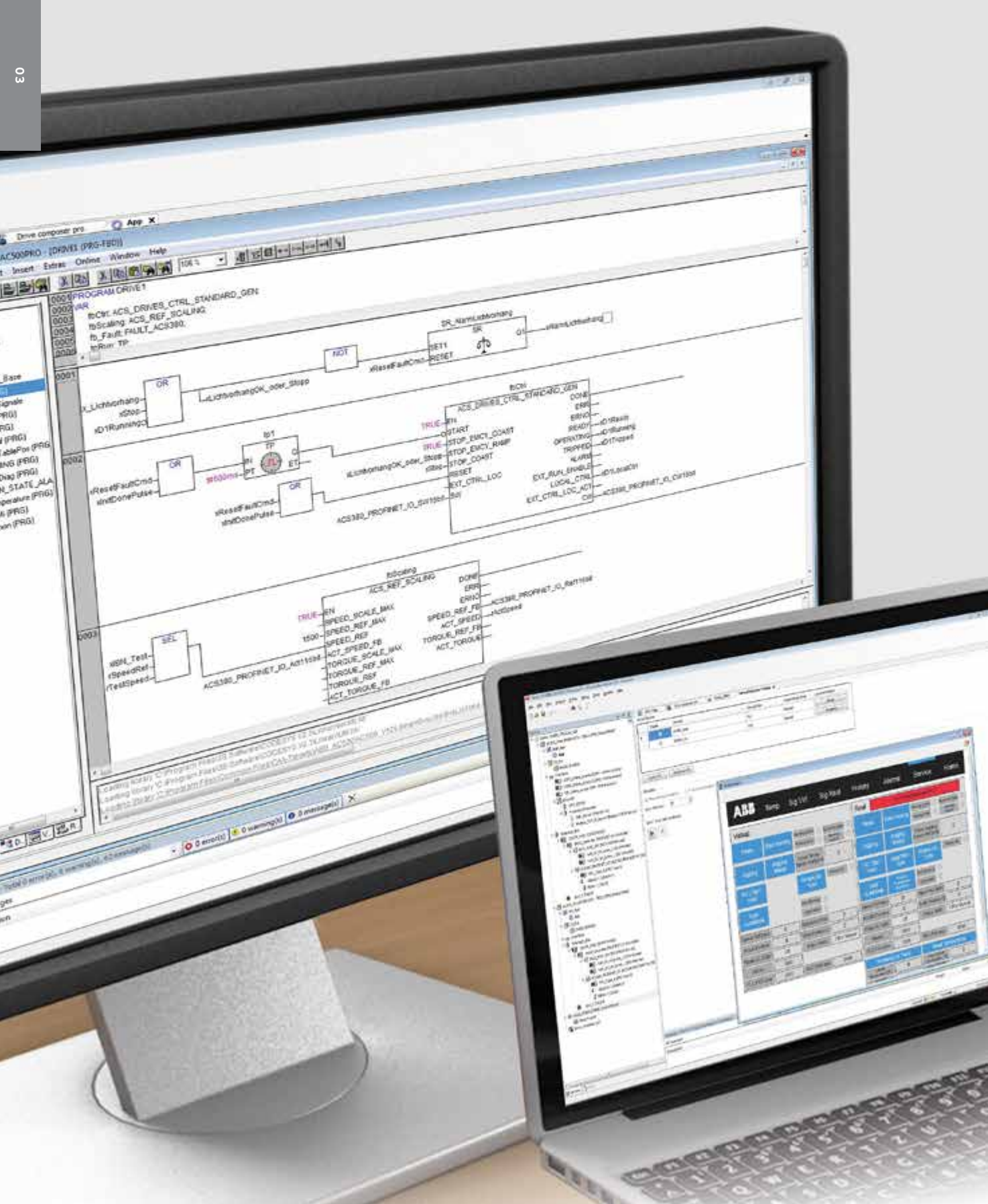

- - Stay in control of your project:
Automation Builder integrates engineering tools for PLCs, safety, drives, motion and control panels
- - Reduce risk: Manage complexity and realize connectivity easily
- - Increase efficiency:
Build comprehensive solutions with integrated engineering that add value to your business
- - Combine tools: One common intuitive interface for configuring, programming, debugging and maintaining automation projects
- - Save time: Test systems effortlessly in virtual time without real hardware using advanced simulation support

ABB Ability™ Automation Builder

Ordering data

Automation Builder

- Automation Builder connects the engineering tools for PLC, safety, drives, motion and control panels. The software suite integrates products into solutions that create value for your customers, giving you greater control of your projects, reducing risk and saving time.
- Open systems win. They lead to more innovation, value and freedom of choice for your business. Automation Builder enables you to adapt the tool chain to your needs and workflows. The software is open for your specific product and communication technology to build your distinct solution.
- Automation Builder provides advanced features, further increasing engineering productivity for your automation solutions.
- Freemium license model with high flexibility in using the licenses. Licenses can be activated on PCs, USB license dongles or license servers (including borrowing of licenses for offline use).
- For details please refer to Automation Builder – Software Features.

Automation Builder Editions

For	Description	Type	Order code
Free 61131-3 engineering for simple PLC solutions	Automation Builder 2.x Basic (1)(2)	-	-
Integrated Engineering for PLC, drives, motion, SCADA, panels	Automation Builder 2.x Standard (3)	DM200-TOOL	1SAS010000R0102
	Automation Builder 2.x Standard Network (2)	DM204-TOOL-NW	1SAS010004R0102
Integrated Engineering for PLC, drives, motion, SCADA, panels and features for engineering productivity and collaboration	Automation Builder 2.x Premium (2)(4)	DM202-PREM	1SAS010002R0102

Automation Builder add-ons

Functional safety engineering	AC500-S Safety PLC programming	DM220-FSE (3) DM221-FSE-NW (2)	1SAS010020R0102 1SAS010021R0102
Collaborative engineering support	Professional Version Control with Subversion for Automation Builder 2.x	DM207-PVC (3) DM214-PVC-NW (2)	1SAS010007R0102 1SAS010014R0102
Static code analysis	Professional Static Analysis for Automation Builder 2.x	DM210-PSA (3) DM217-PSA-NW (2)	1SAS010010R0102 1SAS010017R0102
Advanced simulation support	Advanced simulation capabilities for Automation Builder 2.x (5)	DM250-VCP (3) DM251-VCP-NW (2)	1SAS010050R0102 1SAS010051R0102

Accessories

Automation Builder licensing based on a USB Key	USB Key for Automation Builder without license (6)	DM-KEY	1SAP193600R0001
---	--	--------	-----------------

All Automation Builder PC software licenses can be installed either on engineering PCs or on USB dongles. Network licenses can also be installed on a license server. The licenses can be transferred between computers or dongles unlimited times.

(1) Free license

(2) Network license for shared usage within a local area network or for usage on Windows Server operating systems. Per license one user can use the license at the same time.

Network licenses that can be borrowed for offline use are available on request.

(3) Single user license - bound to PC or DM-KEY (USB Key)

(4) Edition upgrade licenses from Automation Builder 2.x Standard to Automation Builder 2.x Premium are available on demand.

(5) Expert function - only available on request

(6) Does not contain license. Automation Builder license must be purchased separately. Can carry an arbitrary number of licenses.



Automation Builder

ABB Ability™ Automation Builder

Ordering data

AC500 Library Licenses

For	Description	Type	Order code
all AC500 V2 CPUs	Solar library	PS562-SOLAR	1SAP195000R0101
all AC500 V2 CPUs	Water library	PS563-WATER	1SAS030000R0101
all AC500 V2 CPUs	Motion Control library, Extended	PS552-MC-E	1SAP192100R0102
all AC500 V2 CPUs	Temperature control library	PS564-TEMPCTRL	1SAS030010R0101
all AC500 V2 CPUs	BACnet library B-ASC profile	PS565-BACnet-ASC	1SAP195500R0101

Delivery includes a single user license, which can be used for creating applications for an unlimited number of CPUs. All library licenses can be installed on engineering PCs, on USB dongles or on Windows Server operating systems. The licenses can be transferred between computers or dongles unlimited times.

AC500 Runtime Licenses

For	Description	Type	Order code
all AC500 CPUs	Modbus TCP HA runtime license	PS5601-HA-MTCP	1SAP195400R0101
all AC500 V3 CPUs	IEC 61850 protocol runtime license (1)	PS5602-61850	1SAP195600R0101
all AC500 V3 CPUs	KNX IP protocol runtime license (1)	PS5604-KNX	1SAP195800R0101
all AC500 V3 CPUs	BACnet protocol B-BC runtime license (1)	PS5607-BACnet-BC	1SAP195550R0101
all AC500 V3 CPUs	Data logger runtime license for AC500 V3	PS5609-Log	1SAP195002R0101
PM5072	Data logger runtime license for PM5072	PS5609-Log-e	1SAP195004R0101
all AC500 V3 CPUs	Motion control library runtime license	PS5611-MC	1SAP192150R0101
AC500 V3/AC500-eCo V3	Ethernet/IP scanner runtime license for AC500 V3 (for PM5032, PM5052, PM5072 and PM56xx)	PS5613-EIP-S	1SAP196101R0101
AC500-eCo V3	Ethernet/IP scanner runtime license for AC500-eCo V3 (for PM5032, PM5052 and PM5072)	PS5613-EIP-S-e	1SAP196103R0101
AC500 V3/AC500-eCo V3	Ethernet/IP adapter runtime license for AC500 V3 (for PM5032, PM5052, PM5072 and PM56xx)	PS5613-EIP-A	1SAP196100R0101
AC500-eCo V3	Ethernet/IP adapter runtime license for AC500-eCo V3 (for PM5032, PM5052 and PM5072)	PS5613-EIP-A-e	1SAP196102R0101

For using runtime licensed features one license per CPU is required. The license has to be installed on the AC500 V3 CPU either by connecting it to Automation Builder or via Memory card that has been prepared by Automation Builder for license activation.

The licenses can be transferred between AC500 V3 CPUs unlimited times.

(1) Also available for AC500-eCo V3 PM5072

Further application libraries and examples:

Please check and download further libraries and examples from: new.abb.com/plc

Use English language setting, then click on “Application Examples”.

Application Examples explain functionality by using e.g. standard Automation Builder libraries and functions in simple examples. They are tested in the described example configuration and functionality only, they come with documentation and are free of charge.

Applications Examples help to minimize valuable programming and testing time for specific applications.



AC500 libraries

ABB Ability™ Automation Builder

Software features

Automation Builder		Basic	Standard	Premium
Features and target hardware		Basic system engineering FREE	Integrated system engineering	Productivity and collaboration
Productive engineering	Integrated engineering for PLCs, safety, motion, drives and control panels	○	●	●
	Integrated tool suite installation and maintenance (online and offline)	●	●	●
	Project handling including project archive and backup features	●	●	●
	Project lifecycle support (version profiles and project migration)	●	●	●
	Native language support in EN, DE, ES, FR, CN	●	●	●
	Support of standardization and re-use by flexible configurations of machine variants and advanced I/O device handling	●	●	●
	Support of re-use by cross project and cross Automation Builder instance copy&paste	●	●	●
	ECAD roundtrip engineering - AC500 and EPLAN / Zuken E3			●
	ECAD roundtrip engineering for 3rd party devices - PLC and EPLAN / Zuken E3			●
	Bulk data import/export with change control to any tool via CSV (also via copy&paste)			●
	Bulk data import/export of device and I/O lists and IEC 60870-5-104			●
	Change management support by project compare			●
	Automation of engineering (execution of Python scripts)			●
	Virtual system testing based on Virtual Commissioning Technology		○	○
Collaborative engineering support by Professional Version Control with Subversion			○	
PLC engineering (AC500 V2)	For: AC500-eCo, AC500 V2, AC500-XC, AC500-S Safety, AC500 local I/O modules, AC500 extension modules			
PLC application programming (IL, LD, FBD, SFC, ST) plus CFC	●	●	●	
PLC firmware update, download and online change to single or several PLCs	●	●	●	
PLC simulation, diagnosis and debugging	●	●	●	
Integrated firmware identification and update (PM and CM devices)	●	●	●	
Configuration of communication protocols for TCP/IP, Modbus, CS31, IEC 60870-5-104	●	●	●	
Configuration of communication protocols for PROFINET, EtherCAT, PROFIBUS DP, CAN (all via coupler)		●	●	
Condition Monitoring CMS: configuration, libraries for CMS control and wave file handling		●	●	
C/ C++ application programming (GNU compiler)			●	
Advanced simulation support including virtual PLCs		○	○	
PLC engineering (AC500 V3)	For: AC500 V3 and supported AC500 local I/O modules and AC500 extension modules			
PLC application programming (LD, FBD, SFC, ST) plus CFC	●	●	●	
PLC firmware update, download and online change to single PLC	●	●	●	
PLC diagnosis and debugging	●	●	●	
Integrated firmware identification and update (PM and CM devices)	●	●	●	
Configuration of communication protocols for TCP/IP, Modbus TCP, Modbus RTU, CAN	●	●	●	
Configuration of onboard communication protocols for IEC 60870-5-104, IEC 61850, BACnet, KNX		●	●	
Configuration of communication protocols for PROFINET, EtherCAT, CAN (all via coupler)		●	●	
Static code analysis		○	○	
Advanced simulation support including virtual PLCs (in preparation)		○	○	
Safety PLC engineering (integrated solutions)	For: AC500-S Safety CPU, Safety I/Os and PROFIsafe devices			
Safety PLC application programming (LD, FBD, ST)		○	○	
Fieldbus protocol engineering for PROFIsafe		○	○	
Safety Verification Tool		○	○	
SCADA engineering	For: ABB zenon			
Integrated SCADA and PLC engineering with ABB zenon Editor			○	○

ABB Ability™ Automation Builder

Software features

Automation Builder		Basic	Standard	Premium
Features and target hardware		Basic system engineering FREE	Integrated system engineering	Productivity and collaboration
Control Panel engineering	For: CP600, CP600-Pro, CP600-eCo, CP600-WEB, PB610-R			
	CP600 , CP600 2 nd generation and CP600-Pro panel configuration with PB610 Panel Builder 600	○	●	●
	CP600-eCo panel configuration with PB610 Panel Builder 600	●	●	●
	PLC tag data import	●	●	●
	Control Panel simulation	●	●	●
Drive engineering	For: ACS355, ACS380, ACS480, ACS550, ACS580, ACS850, ACQ810, ACS880, DCS880, ACSM1			
	Drive management, configuration and diagnosis with common process data editor (Drive - PLC)		●	●
	Drive engineering in Drive composer pro	○	●	●
Motion engineering	For: MicroFlex e150, Motiflex e180, Motiflex e190			
	Motion application engineering with Mint WorkBench	●	●	●
	PLC tag data import	●	●	●
Modbus TCP engineering	For: CI521-MODTCP, CI522-MODTCP			
	Configuration and diagnosis of unbundled Modbus TCP CI (communication interface) devices	●	●	●
Solution engineering	Drive library (PS553-Drives, PS5605-Drives)	●	●	●
	MQTT and JSON libraries	●	●	●
	Motion control wizard, CAM editor and library V3: PS5611-MC (1)	○	○	○
	Motion control library V2: PS552-MC-E	○	○	○
	Solar library V2: S562-SOLAR	○	○	○
	Water library V2: PS563-WATER	○	○	○
	Temperature Control library V2: PS564-TEMPCTRL	○	○	○
	BACnet - ASC library V2: PS565-BACnet-ASC	○	○	○
	BACnet - BC protocol V3: PS5607-BACnet-BC, (incl. ASC) (1)		○	○
	AC500 High Availability V2: HA-CS31 library		●	●
	AC500 High Availability HA-Modbus TCP library V2/V3: PS5601-HA-MTCP (1)		○	○
	KNX-protocol V3: PS5604-KNX (1)		○	○
	IEC 61850 for AC500 V3: PS5602-61850 (1)		○	○
	PackML library (*)		●	●
	FTP client library (PS554) (*)		●	●
	Signal Processing Package (*)		●	●
	Pumping library (PS571) (*)		●	●
HVAC library (*)		●	●	
Process control objects (PCO) library (*)	●	●	●	
Ethernet/IP (PS5613-ETHIP) (1)		●	●	
Further features	PLC Multidownload tool for large installations	●	●	●
	OPC server and clients, service tool, PLC gateway, IP configuration and visualization	●	●	●
Operating systems	Windows 11 (32/64 Bit) Professional / Enterprise, Windows 10 (32/64 Bit) Professional / Enterprise, Windows Server 2012 R2 64 Bit, Windows Server 2019 (2)	●	●	●
PC requirements	Minimum: 1 GHz, 4 GB RAM, 5-18 GB free disk space	●	●	●

● included

○ optional (additional license required) as integrated tool / feature / library

○ optional (additional license required) as standalone tool / feature - not integrated in Automation Builder

(1) additional runtime license per PLC required

(2) Network license required to run Automation Builder on server operating systems

(*) Technology Preview: Technology Previews are non-final versions of our product and should not be taken as a measure of the fit, finish, capability, and overall quality of the product.

ABB Ability™ Automation Builder

Library features



PS562-SOLAR, PS5617-SOLAR

Solar tracker solution library

Library for solar tracking applications enabling fast engineering, especially together with ABB's drives and motors

Covers different tracker configurations and different algorithms for accuracy needs

- Control of trackers in parabolic trough, power tower, PV and CPV applications.

Complete library package for different tracking use cases, plug and play:

Example program with detailed explanations and visualizations

- Control of the tracker adaptable to different needs and conditions, to achieve maximum efficiency of installation
- Exact positioning of different axes with the following accuracies:
 - NOAA algorithm 0.03 Grad
 - NREL algorithm 0.0003 Grad.
- Input / sensor adaptation
- Communication
- Different actuators / drives control
- All needed modes for simple commissioning and manual operation:
 - Fast and simple calibration of the trackers, offering manual repositioning and fine tuning
 - Safety positions
 - Back tracking.

PS563-WATER

Water solution library

Library supporting the most common functions in many water applications

Flexible data logging options:

- Especially suited for remote communication like GSM/GPRS
- Timestamp in logging
- Integrated variants for simple use with IEC 60870-5-104
- Logging to files: storage capacity only dependent on memory availability
- Flexible log conditions (cyclic, event or tolerance based).

Support for pumping station functions with different operation modes

- Standard multidrive functions (PLC based)
- Advanced functionality together with ABB ACS and ACQ drives
- Detailed diagnosis
- Energy efficiency functions
- Multidrive functions
- Flow estimation.

Application examples for fast engineering and startup.

PS564-TEMPCTRL

Temperature control library

Library packet for advanced temperature control applications

Includes extended, flexible PID functionality with Auto-tune for temperature control

- Enhanced response time and reduced overshoots and oscillations
- Option to optimize control for very different heating and cooling characteristics.
- Enhanced tolerance to thermocouple input noise
- Normal and standby- setpoints
- Multi-level temperature monitoring and alarms provides flexible operation and protection for machine and process
- Logging enables complete overview of the actual situation and past behavior
- Configurable output timing, synchronization for peak load shaving in multi-zone setups
- Simulation blocks enable off-line setup and pre-test of a new project
- Group-programming

Example projects, including adaptable HMI project for CP600 family, well suited for multi zone and grouped temperature control e.g. in Extrusion:

- Easy to use operator interface
- Provides quick access to setup, monitoring and tuning screens for multiple zones
- Easily extendable to a large number of zones
- Zones: heat-, cool-only or heat-and-cool

License Package (Software is part of Automation Builder)

PS562-SOLAR: All AC500 V2 CPUs
NOAA: PM554-XX and above
NREL: PM573-ETH and above

All AC500 V2 CPUs
Logging: PM573 and above.

All AC500 V2 CPUs.

PS5617-SOLAR: All AC500 and AC500-eCo V3 CPUs (1)

(1) planned

ABB Ability™ Automation Builder

Library features



PS552-MC-E

Motion control library

Library enabling fast and standardized engineering according to PLCopen standard when using ABB's AC500 PLC for motion control, especially together with ABB's motion control Drives.

Covers different motion control options for single and multi-axes motion control applications:

- Drive-Based and PLC-Based motion
- In PLC based interpolation, the position control loop could be closed in the PLC or drive (with synchronized network)
- Single axis, multi-axes and coordinated motion
- Defined Jerk limitation by polynomial interpolation
- Spline interpolation or polynomial interpolation for cam curves, position velocity or acceleration profiles available
- Possible to switch over between different movements and cam curves on the fly
- latch functionality by utilizing fast drive inputs for ACS350, ACS800, ACSM1
- Drive based motion: commands from PLC, drives perform interpolation and control loop
- Supports the new Pulse Train Output module FM562.

PLCopen functions:

- Administrative Function Blocks
- Single axis Function Blocks
- Multi-axes Function Blocks
- Homing Function Blocks
- Coordinated Motion Function Blocks
- Additional ABB specific Function Blocks for further simplification.

License Package (Software is part of Automation Builder)

All AC500 V2 CPUs (options and no. of blocks/ functions and performance will depend on CPU size and memory).

PS565-BACnet-ASC

BACnet communication library

This library enables AC500 PLCs to connect OEM or infrastructure applications to BMS (Building Management Systems) or other controllers.

The PS565-BACnet-ASC library enables AC500 to serve as BACnet server device, complying with the B-ASC Device Profile and interfacing control requirements, and acting as hardwired or Modbus-to-BACnet gateway.

It supports BACnet IP (Ethernet) and BACnet MS/TP (serial) networks. The scalable AC500 platform is compatible with the BACnet library starting from eCo PM5x6 with larger memory (~ 300 objects) up to PM595 (more than 5000 objects).

The very transparent, object-oriented publish and subscribe approach of BACnet allows efficient and well-documented engineering and collaboration of many different parties in large infrastructure projects.

Highlights

- Easy-to-use BACnet communication directly in the CPU
- No coupler or gateways required
- Cost-efficient particularly for OEMs and projects
- Interfacing other non-BACnet devices to BMS.

BACnet for AC500 is BTL approved and certified.

All AC500 V2 CPUs, starting from PM5x6 (~300 objects) up to PM595 (>5000 objects)

PS573-PCO

Process control objects library

Facilitates the use of AC500 as controller in DCS solutions by providing function blocks for easy integration into the process visualization.

Twelve function blocks are available which cover the following functionalities:

- Digital and analog setpoints
- Analog measurement with threshold alarm functions
- Valve control
- Motor control with or without variable speed drives
- Proportional integral controller

The function blocks have an internal interface to the DCS system. Status and control are exchanged with the DCS system via OPC DA. For ABB Ability™ System 800xA an optional object library is available which contains symbols and faceplates that match the function blocks.

(No license required)

All AC500 V2 CPUs have an onboard Ethernet interface (number of function blocks and performance will depend on the CPU size and memory).

ABB Ability™ Automation Builder

Runtime license features



PS5601-HA-MTCP

High availability library using Ethernet (Modbus TCP)

Runtime license per CPU to download library into the CPU.

Same philosophy as proven serial/CS31 based library.

Enables hot-standby redundancy and bumpless transfer with standard AC500 CPUs.

Supports 3 redundancy levels:

- CPU
- I/O communication
- SCADA communication

Library package containing libraries based on Modbus TCP for field communication and using CI52x communication interface modules as I/O clusters with redundant connection.

Ethernet redundancy based on externally managed switches: Ethernet network can be independent of the redundancy mechanism used.

- Daisy chain in ring configuration of CI52x with MRP as redundancy protocol
- Fast reaction and switchover nearly independent of the number of clusters
- Possibility of integrating other devices e.g. ABB drives into the redundancy scheme.

Scalable redundancy, where CPUs can also be placed far away from each other (...kilometers if fiber-optic networks are used).

Includes the AC500 Bulk Data Manager as a tool for efficient configuration and cluster engineering.

- Configuration and export of projects, clusters, modules/parameters, signal names, visualization ("code generation")

Application examples for fast engineering and startup.

Runtime license (Software is part of Automation Builder)

All AC500 V2 and V3 CPUs

PS5602-61850

IEC 61850 MMS server and GOOSE communication

This runtime license enables the AC500 V3 PLC to connect to substation type equipment (IEDs) or act as IED.

The protocol library and configuration tool are part of Automation Builder. The runtime license is needed for download.

61850 server edition 1 allows:

- sending MMS messages to ensure a safe data communication – no real time support
- publishing and subscribing to GOOSE messages for high priority peer-to-peer data exchange between different servers to ensure a data transmission with minimal delay
- up to 5 client connections per server
- up to 50 entries per dataset
- up to 20 datasets

Automation Builder used as IED configuration tool

- Import / export of SCL files formats
- ICD – IED capability description file
- SCD – substation configuration description file
- CID – configured IED description file

Basic display options

Highlights

- Wide set of Logical Nodes provided
- Further Logical Nodes can be defined
- Implementation can be programmed freely in IEC 61131.

The IEC 61850 protocol of the AC500 PLC is TÜV certified.

All AC500 V3 CPUs

PS5604-KNX

KNX IP communication

This runtime license enables the AC500 V3 PLC to connect to KNX IP.

The protocol and configuration options are part of Automation Builder and FW. The runtime license is needed for download.

Support of

- Up to 1000 group objects
- Programming the physical address via ETS
- Downloading the KNX group address linking via ETS

Highlights

- Easy to use KNX communication directly in CPU due to tight ETS5 and Automation Builder integration via DCA
- No coupler or gateways needed
- Cost-efficient especially for OEMs and projects
- Enables holistic building automation solutions.

All AC500 V3 CPUs

ABB Ability™ Automation Builder

Runtime license features



PS5607-BACnet-BC

BACnet communication

This runtime license enables the BACnet protocol on AC500 PLCs to connect OEM or infrastructure applications to BMS (Building Management Systems) or other controllers.

The PS5607-BACnet-BC license enables AC500 to act as BACnet server and client device, complying with the B-BC device profile.

It supports the use of BACnet IP (Ethernet) and BACnet MS/TP (serial) (1) networks to be used with the scalable AC500 platform V3 CPUs.

The very transparent, object-oriented publish and subscribe approach of BACnet allows efficient and well-documented engineering and collaboration of many different parties in large infrastructure projects.

Highlights

- Comfortable configuration and editing in the Automation Builder with library support
- Easy-to-use BACnet communication directly in the CPU
- No coupler or gateways required
- Cost-efficient, particularly for OEMs and projects
- Interfacing other non-BACnet devices to BMS.

BACnet for AC500 is BTL approved and certified.

PS5611-MC

Motion control library with axis wizard, CAM editor

Runtime license enabling fast and standardized engineering according to PLCopen standard when using ABB's AC500 V3 and AC500-eCo V3 PLCs for motion control.

The motion solution wizard helps to setup most efficiently EtherCAT and PTO axis as well as CAM curves and tables and link them to the motion control library.

Covers different motion control options for single and multi-axis motion control applications:

- PLC-based interpolation, the position control loop can be closed in the PLC or drive (with synchronized network)
- Single axis and multi-axis motion
- Defined Jerk limitation by polynomial interpolation
- Spline interpolation or polynomial interpolation for cam curves, position, velocity or acceleration profiles available
- Possibility for switching over between different movements and cam curves on the fly
- Latch functionality with drive support
- Virtual axes possible
- Same PLCopen blocks to support different drives, communication networks and control principles
- Application-specific interpolation algorithms can be integrated
- Supports AC500-eCo V3 with Pulse Train Output.

PLCopen functions:

- Administrative function blocks
- Single axis function blocks
- Multi-axis function blocks
- Homing function blocks
- Additional ABB-specific function blocks for further simplification.

Runtime license (Software is part of Automation Builder)

All AC500 V3 CPUs

All AC500 V3 CPUs including AC500-eCo V3 (for PTO with PLCopen)

(1) MS/TP in preparation

ABB Ability™ Automation Builder

Productivity features

Object-oriented programming of AC500 V3 CPUs

All essential features of standard object-oriented programming are included in Automation Builder's object-oriented programming:

- Real object-oriented programming, fully compliant with the third edition of the IEC 61131-3 standard in all available editors
- Encapsulation of object-oriented program code in libraries with functional call interfaces: Convenient provision of e.g. system functions or special algorithms for PLC programmers without exposing the intellectual property
- Inheritance of POUs to similar application parts to reduce development time and errors
- Object-orientation is not a must: Functional and object-oriented programming can be used and mixed as required.

Engineering Productivity

- State-of-the-art editors providing all required software development features like intellisense, refactoring or browsing of references
- Input assistance for the input and configuration of data
- User-friendly programming with mouse and keyboard in all IEC 61131-3 editors
- Comprehensive project comparison, also for graphic editors
- Numerous security features for the protection of the source code and for safeguarding the operation of the controller.

HMI integration

Synchronization of connection settings and access to tags on the AC500 PLC.

Drive integration

Seamless integration of ABB Drives connected to AC500 PLCs:

- Common configuration of cyclic data exchange
- Access to the drive via the AC500 PLC - no need for point-to-point connections
- Upload, download and offline editing of drive parameters

Integrated configuration of AC500 software features

All required AC500 software features can be selected and configured by Automation Builder, e.g.

- KNX gateway for connecting to building automation devices
- BACnet B-BC object engineering
- IEC 60870 protocol for data exchange with substations
- Time synchronization via NTP
- Shared variables with other AC500 PLCs
- Security settings, e.g. certificates and user management

Add-on: Professional version control – management of the application project

Professional Version Control is an integrated link to the version control system Subversion (SVN). End users can use this tool to manage independently both the complete IEC 61131-3 project version, as well as the individual application objects. End users benefit from automated management of the source code when developing a project in various teams or over a long period of time.

Add-on: Professional static analysis

With static code analysis it is possible to check the source code of AC500 applications based on pre-defined rules and naming conventions. Additional information on potential development problems is revealed and errors can be detected and eliminated before the application will be tested on the PLC. Static code analysis implements more than 100 pre-defined and partly configurable rules.



ABB Ability™ Automation Builder

Advanced simulation support

Automation Builder 2.0 has introduced advanced simulation support which allows machine builders and system integrators to simulate and automate all kinds of applications with minimum effort. This gives seamless testing of the complete system at an early stage, even when all the necessary hardware is not yet ready. Even complex systems can be built up quickly and efficiently, ensuring smooth interaction of all the components.

Advanced simulation support lets you build simulation models from virtual devices and manage the virtual time and signal exchange between the virtual devices. Furthermore it provides interfaces to control and manipulate the simulation e.g. via OPC UA, OPC DA or via UDP communication.

Virtual devices emulate real hardware. They function as real hardware, provide signals (onboard, local, fieldbus/remote IOs) and variables. Virtual time lets you control the execution of the simulation. Speed up, slow down or freeze the execution for testing and debugging.

By connecting to external simulation tools (e.g. RobotStudio), additional components can be included to these models. This allows to simulate the real system including physical inputs or actuators. The flexible architecture of the advanced simulation support allows to extend your simulation to more advanced aspects, e.g. the dynamic system behavior.



ABB Ability™ Automation Builder

AC500 for general motion control

Automation Builder with integrated motion solution wizard for efficient motion control engineering and workflows

Convenient to start efficiently without programming to set up and work on real, virtual and encoder axes, guided by the motion solution wizard, both for EtherCAT or PTO based synchronized drives.

Completely based on open standards like Codesys and comprehensive PLCopen motion libraries, the fully integrated engineering environment efficiently enables seamless set up, programming and testing from small to complex machinery and complete lines.

One-click axis engineering

The intuitive, easy-to-use wizard supports unique one-click motion axis setup. Then step-by-step configuration vastly simplifies the setup of smaller and high-end motion control applications.

It's all about engineering efficiency

The solution combines the best of two main approaches for effortless motion control engineering: Wizard setup – with in-depth drill down options for expert users later – and intuitive graphic CAM table editors. This future-proof approach not only ensures fast setup but also has a selectable programming depth for flexible machine production options, quality, maintainability and durability through adaptable and expandable gentle movements.

Full insight for fine-tuning

The Automation Builder engineering tool also features comprehensive tools for tracking or visualizing the exact and precise movement of axes, whether virtual, simulated or real, together with other variables or I/O signals. The graphic interfaces, including CAM editors, simplify fine-tuning and allow you to visualize the dynamics of combined movements as required for configuring, improving, operating or diagnosing machine operation.

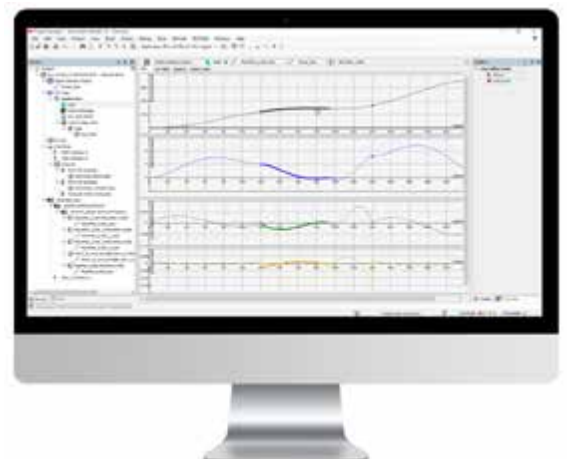
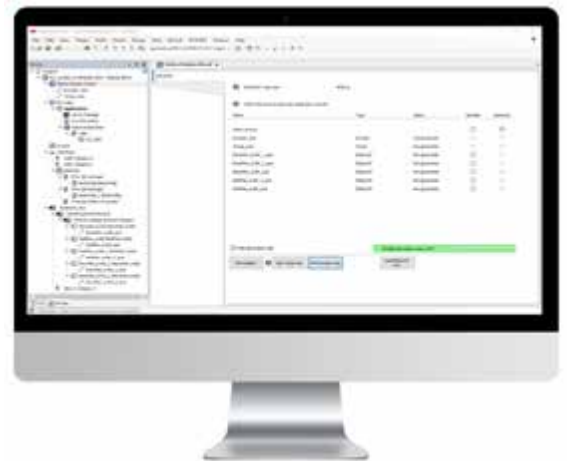

One platform
for all applications



Conveyors

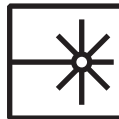

Laser processing



Cut to length

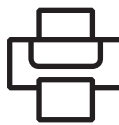

Printing



Pick and place



Labeling

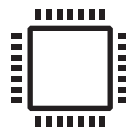

Semiconductor
PCB



Bottling

One platform for all performance classes

The AC500 V3 and AC500-eCo V3 CPUs uniquely scale with one look and feel from cost efficient PTO to real-time synchronized EtherCAT based motion control – all in the same familiar Codesys and PLCopen engineering environment.

The flexible integration of AC500 PLCs, the wizard and electronic CAM and gearing simplifies handling, minimizes the potential for errors and increases overall transparency, saving a lot of time throughout the workflow.

For more details see chapter 2 page 86.



AC500-eCo

Entry level PLC solutions

117	Key features
118–124	Ordering data
125–136	Technical data
137–138	System data

MC

ABB

PM5072

TA5130-KNXPB

PWR
 ERR
 RUN

PRG

COM
0..11

1
2
3
4
5
6
7
8
9
10
11
12
13

10
11
12
13
14
15
16
17
18
19
I10
I11
00

TA5120-2AI-U

IO+

ETH1

ETH2

04

3:

AC500-eCo

Key features



- High performance variant with large memory available
- Simple variant for entry level application

- Up to 10 I/O modules connected to V3 Standard and Pro CPU
- Compatible with all standard I/O modules (S500 and S500-eCo)
- Digital I/O module with configurable I/O available

- Up to two different types of terminal blocks available
- Large number of integrated onboard I/O
- Fast I/O for motion application and axis control
- Onboard I/O extension using option boards for digital or analog channels
- Micro memory card slot for FW/program download and update

- Comprehensive communication and options:
 - Up to two Ethernet interfaces for communication and web server for user defined visualization
 - Up to three serial ports for decentralized I/O and communication using option boards
 - New Ethernet-based communication available

AC500-eCo

Ordering data

AC500-eCo V3 CPUs

- Three performance classes CPU (Basic, Standard and Pro) with large memory
- From low-entry and cost-sensitive to large and complex applications
- One or two independent Ethernet interfaces with integrated switch functionality
- Up to three RS232 or RS485 serial interfaces using option boards
- Micro memory card slot for data storage and program backup
- Real time clock for Standard and Pro CPU, optional for Basic
- Web server functionality with HTML5 Web visualization for Standard and Pro CPU
- Minimum cycle time per instruction: Bit 0.02 μ s, Word 0.02 μ s, Floating point 0,6 μ s.
- High amount of onboard I/Os with relay or transistor outputs
- Onboard high-speed I/Os with motion control function for up to 4 axis PTO
- Extendable with up to three digital, analog or serial option boards
- Standard and Pro version can be locally extended with up to 10 I/O modules (S500 and/or S500-eCo modules can be mixed)
- 24 V DC power supply.

Total user program memory	Onboard I/Os	Relay / Transistor outputs	Integrated communication	Option board slots for extension	Power supply	Type	Order code	Weight (1 pce)
kB	DI/DO/DC							kg
Basic CPU PM5012-x-ETH: 1MB CPU, Ethernet interface, onboard digital I/O, not extendable, 1 slot for option board								
1 MB (thereof 256 kB Program code and Data) (2)(3)	6 / 4 / –	Transistor	1x Ethernet	1	24 V DC	PM5012-T-ETH	1SAP122600R0072	0.225
	6 / 4 / –	Relay	1x Ethernet	1	24 V DC	PM5012-R-ETH	1SAP122700R0072	0.235
Standard CPU PM5032-x-ETH: 2MB CPU, Ethernet interface, RTC and micro memory card, onboard digital I/O, extendable, 2 slots for option board								
2 MB (thereof 512 kB Program code and Data + 1.5 MB Web max.) (2)(3)	12 / 8 / 2	Transistor	1x Ethernet	2	24 V DC	PM5032-T-ETH	1SAP123400R0072	0.253
	12 / 6 / 2	Relay	1x Ethernet	2	24 V DC	PM5032-R-ETH	1SAP123500R0072	0.268
Standard CPU PM5052-x-ETH: 4MB CPU, Ethernet interface, RTC and micro memory card, onboard digital I/O, extendable, 3 slots for option board								
4 MB (thereof 768 kB Program code and Data + about 3 MB Web max.) (2)(3)	12 / 8 / 2	Transistor	1x Ethernet	3	24 V DC	PM5052-T-ETH	1SAP124000R0072	0.257
	12 / 6 / 2	Relay	1x Ethernet	3	24 V DC	PM5052-R-ETH	1SAP124100R0072	0.273
Pro CPU PM5072-x-ETH: 8MB CPU with two Ethernet interface, RTC and micro memory card, onboard digital I/O, extendable, 3 slots for option board								
8 MB (thereof 1 MB Program code and Data + 7 MB Web max.) (2)(3)	12 / 8 / 2	Transistor	2x independent Ethernet with switch	3	24 V DC	PM5072-T-2ETH	1SAP124500R0073	0.265
8 MB (thereof 1 MB Program code and Data + 7 MB Web max.) extended wide temperature (2)(3)	12 / 8 / 2	Transistor	2x independent Ethernet with switch	3	24 V DC	PM5072-T-2ETH(W) (1)	1SAP124400R0073	0.265

Terminal block sets are necessary for each AC500-eCo V3. The terminal blocks must be ordered separately.

(1) Wide extended temperature -20 °C ... +70 °C.

(2) The maximum downloadable application size which is shown in Automation Builder contains all the user program code+user data+web server and infrastructure data. The size is depending on the CPU Type (see the value in the technical data pages).

(3) Memory size of V2 versus V3 CPUs is not comparable. Projects have a different and separate user program code and data memory calculation in Automation Builder 2.4.0 version or later: System, configuration and web server parts are not counted anymore. This results in typically about 50 % lower memory usage compared to V2, and even lower memory usage compared to V3 projects compiled in Automation Builder 2.3.0 or before.



PM5012-x-ETH
Basic CPU



PM5032-x-ETH
Standard CPU



PM5052-x-ETH
Standard CPU



PM5072-T-2ETH(W)
Pro CPU

AC500-eCo

Ordering data

AC500 Runtime Licenses

For	Description	Type	Order code
all AC500 CPUs	Modbus TCP HA runtime license	PS5601-HA-MTCP	1SAP195400R0101
all AC500 V3 CPUs	IEC 61850 protocol runtime license (1)	PS5602-61850	1SAP195600R0101
all AC500 V3 CPUs	KNX IP protocol runtime license (1)	PS5604-KNX	1SAP195800R0101
all AC500 V3 CPUs	BACnet protocol B-BC runtime license (1)	PS5607-BACnet-BC	1SAP195550R0101
all AC500 V3 CPUs	Data logger runtime license for AC500 V3	PS5609-Log	1SAP195002R0101
PM5072	Data logger runtime license for PM5072	PS5609-Log-e	1SAP195004R0101
all AC500 V3 CPUs	Motion control library runtime license	PS5611-MC	1SAP192150R0101
AC500 V3/AC500-eCo V3	Ethernet/IP scanner runtime license for AC500 V3 (for PM5032, PM5052, PM5072 and PM56xx)	PS5613-EIP-S	1SAP196101R0101
AC500-eCo V3	Ethernet/IP scanner runtime license for AC500-eCo V3 (for PM5032, PM5052 and PM5072)	PS5613-EIP-S-e	1SAP196103R0101
AC500 V3/AC500-eCo V3	Ethernet/IP adapter runtime license for AC500 V3 (for PM5032, PM5052, PM5072 and PM56xx)	PS5613-EIP-A	1SAP196100R0101
AC500-eCo V3	Ethernet/IP adapter runtime license for AC500-eCo V3 (for PM5032, PM5052 and PM5072)	PS5613-EIP-A-e	1SAP196102R0101

For using runtime licensed features one license per CPU is required. The license has to be installed on the AC500 V3 CPU either by connecting it to Automation Builder or via Memory card that has been prepared by Automation Builder for license activation.

The licenses can be transferred between AC500 V3 CPUs unlimited times.

(1) Also available for AC500-eCo V3 PM5072.

AC500-eCo

Ordering data

Terminal block sets for AC500-eCo V3 CPU

Content of the sets	Connection type	Cable entry	Type	Order code	Weight (1 set) kg	
For Basic CPU						
1x 3 poles for power supply, 1x 13 poles I/O terminal blocks	Screw	5 mm pitch	Side	TA5211-TSCL-B	1SAP187400R0001	0.034
1x 3 poles for power supply, 1x 13 poles I/O terminal blocks	Spring	5 mm pitch	Front	TA5211-TSPF-B	1SAP187400R0002	0.035
For Standard and Pro CPU						
1x 3 poles for power supply, 1x 13 + 1x 12 poles I/O terminal blocks	Screw	5 mm pitch	Side	TA5212-TSCL	1SAP187400R0004	0.054
1x 3 poles for power supply, 1x 13 + 1x 12 poles I/O terminal blocks	Spring	5 mm pitch	Front	TA5212-TSPF	1SAP187400R0005	0.055

Only ABB terminal blocks must be used with AC500-eCo V3.



TA5211-TSCL-B

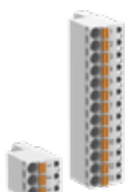

TA5211-TSPF-B



TA5212-TSCL



TA5212-TSPF

Accessories for AC500-eCo V3 CPUs

Description	Type	Order code	Weight (1 set) kg
For Basic CPU only			
Real Time Clock without battery, option board for AC500-eCo Basic CPU	TA5131-RTC	1SAP187200R0002	0.031
For all AC500-eCo V3 CPU types			
Micro memory card 8 GB for program, data or firmware update, with adapter (1)	MC5102	1SAP180100R0002	0.015
Screw mounting accessory for AC500-eCo V3 CPU (same as PM595-4ETH-x), 20 pieces per packing unit	TA543	1SAP182800R0001	0.011
Cable binding pluggable accessory, 20 pieces per packing unit	TA5301-CFA	1SAP187500R0003	0.039
Option board cover, removable plastic part, 6 pieces per packing unit	TA5300-CVR	1SAP187500R0001	0.056
Input simulator, 6 switches, 24 V DC	TA5400-SIM	1SAP187600R0001	0.033

(1) For temporary use, e.g. firmware- or project-download to the CPU. Not to be used during vibration or shock.



TA5301-CFA



TA543



TA5300-CVR



MC5102 and adapter



Input simulator

AC500-eCo

Ordering data

AC500-eCo V3 option boards

- Up to three option board slots for extension according to CPU type
- All option board modules can be used on all option board slots of a CPU
- Up to three RS232 or RS485 serial interfaces using option boards
- Four different option boards for analog channels extension / Three different option boards for digital channels extension
- KNX push button address switch
- All the option boards are delivered with spring connector terminal block.

Description	Onboard I/Os DI/DO/AI/AO	Relay / Transistor outputs	Type	Order code	Weight (1 pce) kg
Option board for digital input/output channel extension					
4 DI digital input channels 24 V DC, 5 pole spring/ cable front terminal 3.50 mm pitch	4 / - / - / -	-	TA5101-4DI	1SAP187000R0001	0.015
			TA5101-4DIW (1)	1SAP187000R0201	0.015
4 DO digital output channels transistor 24 V DC / 0.5A, 7 pole spring/cable front term. 3.50 mm pitch	- / 4 / - / -	Transistor	TA5105-4DOT	1SAP187000R0002	0.016
			TA5105-4DOTW (1)	1SAP187000R0202	0.016
2 DI/2DO digital in/output chan. Trans. 24 V DC / 0.5A, 7 pole spring/cable front term. 3.50 mm pitch	2 / 2 / - / -	Transistor	TA5110-2DI2DOT	1SAP187000R0003	0.015
			TA5110-2DI2DOW (1)	1SAP187000R0203	0.015
Option board for analog input/output channel extension					
2 AI analog input channels U/I, 0 ... 10V/0 ... 20mA, 6 pole spring/cable front term. 3.50 mm pitch	- / - / 2 / -	-	TA5120-2AI-UI	1SAP187100R0001	0.015
			TA5120-2AI-UIW (1)	1SAP187100R0201	0.015
2 AI analog input channels TC thermocoupler, 6 pole spring/cable front term. 3.50 mm pitch	- / - / 2 / -	-	TA5122-2AI-TC (1)	1SAP187100R0004	0.015
			TA5122-2AI-TCW (1)	1SAP187100R0204	0.019
2 AI analog input channels RTD PT100, PT1000, 8 pole spring/cable front term. 3.50 mm pitch	- / - / 2 / -	-	TA5123-2AI-RTD	1SAP187100R0002	0.019
			TA5123-2AI-RTW (1)	1SAP187100R0202	0.015
2 AO analog output channels U/I, 0 ... 10V/0 ... 20mA, 6 pole spring/cable front term. 3.50 mm pitch	- / - / - / 2	-	TA5126-2AO-UI	1SAP187100R0003	0.019
			TA5126-2AO-UIW (1)	1SAP187100R0203	0.019

(1) In preparation



TA5101-4DI(W)



TA5105-4DOT(W)



TA5110-2DI2DOT(W)



TA5120-2AI-UI(W)



TA5126-2AO-UI(W)



Slot 1



Slot 1

Slot 2



Slot 1

Slot 2

Slot 3



Slot 1

Slot 2

Slot 3

	Basic PM5012-x-ETH	Standard PM5032-x-ETH	Pro PM5052-x-ETH	Pro PM5072-T-ETH(W)
Option board slot 1	●	●	●	●
Option board slot 2	-	●	●	●
Option board slot 3	-	-	●	●

Usable option board on AC500-eCo V3 CPU

TA5130-KNXPB	-	-	-	●, max 1 (W)
TA5131-RTC	●, max 1	-	-	-
TA5101-4DI	●	●	●	● (W)
TA5105-4DOT	●	●	●	● (W)
TA5110-2DI2DOT	●	●	●	● (W)
TA5120-2AI-UI	●	●	●	● (W)
TA5122-2AI-TC	●	●	●	● (W)
TA5123-2AI-RTD	●	●	●	● (W)
TA5126-2AO-UI	●	●	●	● (W)
TA5141-RS232I	●	●	●	● (W)
TA5142-RS485I	●	●	●	● (W)
TA5142-RS485	●	●	●	● (W)

AC500-eCo

Ordering data

Description	Communication type	Type	Order code	Weight (1 pce) kg
Option board for serial communication extension				
RS232 serial adapter isolated, 5 pole spring/cable front terminal 3.50 mm pitch	RS232 isolated	TA5141-RS232I	1SAP187300R0001	0.015
		TA5141-RS232W (1)	1SAP187300R0201	0.015
RS485 serial adapter isolated, 5 pole spring/cable front terminal 3.50 mm pitch	RS485 isolated	TA5142-RS485I	1SAP187300R0002	0.016
		TA5142-RS485IW (1)	1SAP187300R0202	0.016
RS485 serial adapter non-isolated, 5 pole spring/cable front terminal 3.50 mm pitch	RS485 non-isolated	TA5142-RS485	1SAP187300R0003	0.015
		TA5142-RS485W (1)	1SAP187300R0203	0.015
Option board for communication address setting or real time clock				
KNX address switch option board, 1 push button	-	TA5130-KNXPB	1SAP187200R0001	0.014
		TA5130-KNXPBW (1)	1SAP187200R0201	0.014
Real Time Clock without battery, option board for AC500-eCo Basic CPU only	-	TA5131-RTC	1SAP187200R0002	0.016

The necessary spring terminal blocks are delivered with each option board. Only ABB terminal blocks must be used with AC500-eCo V3.

(1) In preparation



TA5141-RS232I(W)



TA5142-RS485I(W)



TA5142-RS485(W)



TA5130-KNXPB(W)

Description	Type	Order code	Weight (1 pce) kg
Spare parts for option boards (terminal blocks)			
TA5220-SPF5:S500, terminal block, 5 pole, spring front/cable front, pitch 3.5 mm, pack.unit: 6 piece	TA5220-SPF5	1SAP187400R0012	0.015
TA5220-SPF6:S500, terminal block, 6 pole, spring front/cable front, pitch 3.5 mm, pack.unit: 6 piece	TA5220-SPF6	1SAP187400R0013	0.019
TA5220-SPF7:S500, terminal block, 7 pole, spring front/cable front, pitch 3.5 mm, pack.unit: 6 piece	TA5220-SPF7	1SAP187400R0014	0.022
TA5220-SPF8:S500, terminal block, 8 pole, spring front/cable front, pitch 3.5 mm, pack.unit: 6 piece	TA5220-SPF8	1SAP187400R0015	0.170

Only ABB terminal blocks must be used with AC500-eCo V3.



TA5220-SPF5



TA5220-SPF6



TA5220-SPF7

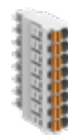

TA5220-SPF8

AC500-eCo

Ordering data

S500-eCo I/O modules

- For central extension of the AC500 or AC500-eCo CPUs
- For decentralized extension in combination with communication interface module DC551-CS31, CI52x-MODTCP, PROFINET CI50x modules, CI592-CS31, PROFIBUS modules CI54x, EtherCAT modules CI51x, and CANopen modules CI58x (not usable with DC505-FBP module and CI590-CS31-HA).

Digital I/O

- DC: Channels can be configured individually as inputs or outputs.

Number of DI/DO/DC	Input signal	Output type	Output signal	Terminal block required		Type	Order code	Weight (1 pce) kg
				9 poles	11 poles			
8 / - / -	24 V AC / DC	-	-	1	-	DI561	1TNE968902R2101	0.113
16 / - / -	24 V AC / DC	-	-	1	1	DI562	1TNE968902R2102	0.116
8 / - / -	100-240 V AC	-	-	1	1	DI571	1TNE968902R2103	0.129
16 / - / -	100-240 V AC	-	-	1	1	DI572	1SAP230500R0000	0.135
- / 8 / -	-	Transistor	24 V DC, 0.5 A	-	1	DO561	1TNE968902R2201	0.118
- / 16 / -	-	Transistor	24 V DC, 0.5 A	1	1	DO562	1SAP230900R0000	0.160
- / 8 / -	-	Relay	24 V AC / DC, 120 / 240 V AC, 2 A	-	1	DO571	1TNE968902R2202	0.138
- / 8 / -	-	Triac	24 V AC, 100 / 240 V AC, 0.3 A	1	1	DO572	1TNE968902R2203	0.120
- / 16 / -	-	Relay	24 V DC, 120 / 240 V AC, 2 A	1	1	DO573	1SAP231300R0000	0.190
8 / 8 / -	24 V DC	Transistor	24 V DC, 0.5 A	1	1	DX561	1TNE968902R2301	0.120
8 / 8 / -	24 V AC / DC	Relay	24 V AC / DC, 120 / 240 V AC, 2 A	1	1	DX571	1TNE968902R2302	0.140
- / - / 16	24 V DC	Transistor	24 V DC, 0.5 A	1	1	DC562	1SAP231900R0000	0.150

Terminal blocks (9 or 11 poles) are necessary for each S500-eCo I/O. The terminal blocks must be ordered separately.

Analog I/O

- Each channel can be configured individually
- Resolution:
 - AI561, AO561, AX561: 12 bits including sign
 - AI562, AI563: 16 bits including sign.

Number of AI/AO	Input signal	Output signal	Terminal block required		Type	Order code	Weight (1 pce) kg
			9 poles	11 poles			
4 / 0	±2.5 V, ±5 V, 0...5 V, 0...10 V, 0...20 mA, 4...20 mA	-	1	1	AI561	1TNE968902R1101	0.120
2 / 0	PT100, PT1000, Ni100, Ni1000, Resistance: 150 Ω, 300 Ω	-	-	1	AI562	1TNE968902R1102	0.121
4 / 0	S, T, R, E, N, K, J, Voltage range: ±80 mV	-	1	1	AI563	1TNE968902R1103	0.123
0 / 2	-	-10...+10 V, 0...20 mA, 4...20 mA	-	1	AO561	1TNE968902R1201	0.118
4 / 2	±2.5 V, ±5 V, 0...5 V, 0...10 V, 0...20 mA, 4...20 mA	-10...+10 V, 0...20 mA, 4...20 mA	1	1	AX561	1TNE968902R1301	0.122

Terminal blocks (9 or 11 poles) are necessary for each S500-eCo I/O. The terminal blocks must be ordered separately.



DI561



AI562



AX561

AC500-eCo

Ordering data

Positioning module

- For central extension of the AC500 or AC500-eCo CPUs V2 version only, not supported by AC500-eCo V3 or AC500 V3 CPUs.
- For decentralized extension in combination with communication interface modules CI50X-PNIO or CI54X-DP.
- The FM562 module provides Pulse Train Outputs for 2 axes. Profile generator integrated.

Number of axis	Input signal	Output signal	Terminal block required		Type	Order code	Weight (1 pce) kg
			9 poles	11 poles			
2	4 digital inputs 24 V (2 per axis)	4 pulse outputs RS422 (2 per axis)	1	1	FM562	1SAP233100R0001	0.118

Terminal blocks (9 or 11 poles) are necessary for each S500-eCo I/O. The terminal blocks must be ordered separately. Library PS552-MC-E is required for programming this module.



FM562

Terminal blocks for S500-eCo I/O modules

Number of poles	Connection type	Cable entry	Type	Order code	Weight (1 pce) kg
9	Screw	Side	TA563-9	1TNE968901R3101	0.018
11	Screw	Side	TA563-11	1TNE968901R3102	0.021
9	Screw	Front	TA564-9	1TNE968901R3103	0.031
11	Screw	Front	TA564-11	1TNE968901R3104	0.036
9	Spring	Front	TA565-9	1TNE968901R3105	0.018
11	Spring	Front	TA565-11	1TNE968901R3106	0.021



Only ABB terminal blocks must be used with AC500-eCo.
Package unit for these terminal blocks = 6.



TA563-9



TA564-11



TA565-9

AC500-eCo

Technical data

AC500-eCo V3 CPUs

Type	PM5012-T-ETH	PM5012-R-ETH	PM5032-T-ETH	PM5032-R-ETH	PM5052-T-ETH	PM5052-R-ETH	PM5072-T-2ETH	PM5072-T-2ETHW
Supply voltage	24 V DC							
Current consumption on 24 V DC								
Min. typ. (module alone)	0.150 A	0.150 A	0.200 A	0.200 A	0.200 A	0.200 A	0.250 A	0.250 A
Max. typ. (all I/Os)	0.150 A	0.850 A	0.900 A	0.900 A	0.900 A	0.900 A	0.950 A	0.950 A
Type of processor / Processor clock frequency	TI ARM Cortex-A9 32-bit-RISC / 300 MHz							
Total RAM memory / Total Flash memory	128 MB / 128 MB							
User program memory	1 MB	1 MB	2 MB	2 MB	4 MB	4 MB	8 MB	8 MB
Maximum downloadable application size (2)	1 MB	1 MB	5 MB	5 MB	7 MB	7 MB	9 MB	9 MB
Thereof User program code and data (dynamically allocated) (1)	256 kB	256 kB	512 kB	512 kB	768 kB	768 kB	1 MB	1 MB
Thereof User web server Data max.	-	-	1.5 MB	1.5 MB	3 MB	3 MB	7 MB	7 MB
User data memory saved in FLASH	8 kB	8 kB	32 kB	32 kB	32 kB	32 kB	100 kB	100 kB
Thereof VAR Retain persistent	4 kB	4 kB	16 kB	16 kB	16 kB	16 kB	36 kB	36 kB
Thereof % M memory (e.g. Modbus register)	4 kB	4 kB	16 kB	16 kB	16 kB	16 kB	64 kB	64 kB
User flash disk (Data-storage, programm access or also external with FTP)	-							
Plug-in memory card (onboard micro memory card socket)	● Depending on micro memory card used: use MC5102 preferably							
Data buffering	Flash EPROM memory							
Real-time clock (with Goldcap back-up)	Optional, use option board TA5131-RTC		●					
Cycle time for 1 instruction (minimum)								
Binary / Word / Floating-point	0.02 μs / 0.02 μs / 0.60 μs							
Program execution								
Cyclical / Time controlled / multi tasking	● / ● / ●							
Minimum cycle time configurable for cyclical task	10 ms		5 ms		2 ms		1 ms	
User program protection by password	●							
Onboard digital inputs								
Channels	6 (thereof 4 high-speed 5 kHz)		12 (thereof 4 high-speed 200 kHz, 4 with 5 kHz)					
Functionality	up to 6 standard or		up to 12 standard or					
Fast counter	up to 2 (5kHz)		up to 4 (100 kHz)					
A/B Encoder with frequency measurement	up to 1 A/B encoder (5 kHz) without touch/reset input		up to 2 A/B encoder (200 kHz) with without Touch/Reset inputs					
Interrupt input with dedicated interrupt task	up to 4		up to 4					
Signal voltage	24 V DC		24 V DC					
Onboard digital outputs								
Channels								
Transistor	4 (thereof 4 high speed 5 kHz)	-	8 (thereof 4 high speed 200 kHz and 4 with 5 kHz)	-	8 (thereof 4 high speed 200 kHz and 4 with 5 kHz)	-	8 (thereof 4 high speed 200 kHz and 4 with 5 kHz)	
Functionality	Up to 4 standard or	-	up to 8 standard or	-	up to 8 standard or	-	up to 8 standard or	
PTO with pulse signal and direction	-	-	up to 2 (200 kHz)	-	up to 2 (200 kHz)	-	up to 2 (200 kHz)	
PTO with CC/CCW pulse outputs	-	-	up to 2 (200 kHz)	-	up to 2 (200 kHz)	-	up to 2 (200 kHz)	
PTO (SW using PWM) pulse and direction	-	-	up to 4 (100/200 (3) kHz)	-	up to 4 (100/200 (3) kHz)	-	up to 4 (100/200 (3) kHz)	

(1) Memory size of V2 versus V3 CPUs is not comparable. Projects have a different and separate User Program code and Data memory calculation in Automation Builder 2.4.0 version or later. System, configuration and web server parts are not counted anymore. This results in typically about 50 % lower memory usage compared to V2, and even lower memory usage compared to V3 projects compiled in Automation Builder 2.3.0 or before.

(2) Maximum downloadable application size: contains user program code, data, web server memory, infrastructure. This is the maximum size of the application which can be downloaded into a CPU with Automation Builder. This value is displayed and splitted into different categories in the resource window of AB SW.

(3) In preparation

AC500-eCo

Technical data

AC500-eCo V3 CPUs

Type	PM5012-T-ETH	PM5012-R-ETH	PM5032-T-ETH	PM5032-R-ETH	PM5052-T-ETH	PM5052-R-ETH	PM5072-T-2ETH	PM5072-T-2ETHW
PWM	up to 4 (100 Hz)	-	up to 4 (30 kHz) and up to 4 (100 Hz)	-	up to 4 (30 kHz) and up to 4 (100 Hz)	-	up to 4 (30 kHz) and up to 4 (100 Hz)	
Limit switch	up to 4	-	up to 8	-	up to 8	-	up to 8	
Residual current at signal state 0	< 0.5 mA							
Demagnetization when switching off inductive loads	must be provided externally							
Relay	-	4	-	6	-	6	-	-
Functionality	-	Standard output	-	Standard output	-	Standard output	-	-
Rated voltage	24 V DC	230 V AC	24 V DC	230 V AC	24 V DC	230 V AC	24 V DC	24 V DC
Nominal current per channel	0.5 A resistive	2 A resistive	0.5 A resistive	2 A resistive	0.5 A resistive	2 A resistive	0.5 A resistive	0.5 A resistive

Onboard digital input /output configurable channels

Channels	-	-	2 digital in/output configurable					
As digital input used	-	-	up to 2					
Signal voltage	-	-	24 V DC					
Functionality	-	-	Standard input					
As digital output transistor used	-	-	up to 2 standard	up to 2 standard or	up to 2 standard	up to 2 standard or	up to 2 standard	
PTO with pulse signal and direction	-	-	-	up to 1 (200 kHz)	-	up to 1 (200 kHz)	-	
PTO with CC/CCW pulse outputs	-	-	-	up to 1 (200 kHz)	-	up to 1 (200 kHz)	-	
PWM	-	-	-	up to 2 (30 kHz)	-	up to 2 (30 kHz)	-	
Limit switch	-	-	-	up to 2	-	up to 2	-	
Rated voltage	-	-	24 V DC	24 V DC	24 V DC	24 V DC	24 V DC	24 V DC
Nominal current per channel	-	-	0.5 A resistive	0.5 A resistive	0.5 A resistive	0.5 A resistive	0.5 A resistive	0.5 A resistive

Max. number of centralized inputs/outputs

Max. number of extension modules on I/O bus	-	up to max. 10 (S500 and/or S500-eCo I/O modules allowed)					
---	---	--	--	--	--	--	--

Maximum size of process image variable on I/O bus	onboard I/O + option board	128 Byte input and 128 Byte output	no limit within 10 I/O modules
Digital inputs	only onboard 6 + 1 option board	320 + 12 + max. 2DC as 2DI + opt. boards (2)	320 + 12 + max. 2DC as 2DI + option boards
Digital outputs	only onboard 4 + 1 option board	320 + 8/6 + max. 2DC as 2DO + opt. boards (2)	320 + 8/6 + max. 2DC as 2DO + option boards
Analog inputs	only 1 option board	max. 64 including option boards (2)	160 + option boards
Analog outputs	only 1 option board	max. 64 including option boards (2)	160 + option boards

Max. number of decentralized inputs/outputs depends on the used standard fieldbus (1)

Option board slots for extension

Each slot can be used for all type of existing option boards, same option board for serial interface or digital/analog I/O extension can be used on several slots per CPU

Max. number of option board slots max.	1	2	3
Type of option board			
KNX communication address switch	-	TA5130-KNXPB only on 1 slot	
Real-time clock (with Goldcap back-up)	TA5131-RTC	-	
Serial interface	TA5141-RS232I, TA5142-RS485/TA5142-RS485I		
Digital in/output channels	TA5101-4DI, TA5105-4DOT, TA5110-2DI2DOT		
Analog in/output channels	TA5120-2AI-UI, TA5122-2AI-TC (1), TA5123-2AI-RTD, TA5126-2AO-UI		

(1) In preparation

(2) Depending on the used S500-eCo or mostly S500 I/O module types, the maximum amount of channel can be lower than these values e.g. using DC532 with high speed counter or AI/AO523 with 16 analog channels. The limit on number of channels is then always given by the maximum size on process image variable within the maximum of 10 I/O modules.

AC500-eCo

Technical data

AC500-eCo V3 CPUs

Type	PM5012-T-ETH	PM5012-R-ETH	PM5032-T-ETH	PM5032-R-ETH	PM5052-T-ETH	PM5052-R-ETH	PM5072-T-2ETH	PM5072-T-2ETHW
Internal interfaces for communication								
COMx	No onboard serial interface, only using additional option boards for serial communication TA5141-RS232I, TA5142-RS485, TA5142-RS485I							
Number of serial interface maximum	1	2			3			
RS232 isolated	● (TA5141-RS232I)							
RS485 non isolated / Isolated	● (TA5142-RS485) / ● (TA5142-RS485I)							
Connection	pluggable spring terminal block delivered with option board							
Modbus RTU Master/Slave, ASCII	●							
Ethernet	1x Ethernet Interface						2x independent Ethernet interfaces for several uses	
Ethernet connection (on the CPU itself)	1x RJ45						2x RJ45 could be used as 2-port switch with 1x interface	
Ethernet functions (1):								
Ethernet Switch on ETH1 / ETH2 with 2x separated interfaces and MAC-Address	-	-	-	-	-	-	●	
Online Access, ICMP (Ping), DHCP	●							
Nb of parallel connections	4		4				6	
IP configuration protocol	●							
UDP data exchange, Network variables	● / ●							
HTTP / HTTPs (integrated Web server)	-		●					
Nb of parallel connections	-		2				4	
Web Visu for data visualisation on web server HTML5	-		●					
NTP (Time synchronization) Server / Client	● / ●							
FTP / FTPs server	-		●					
Nb of parallel connections	-		2					
SMTP client	●							
Socket programming	●							
Modbus TCP Client / Server	● / ●							
Nr of Modbus clients ModMast in parallel on a CPU Master (Server)	8		13		20		30	
Nr of Modbus server in parallel (for SCADA access e.g.)	3		8		10		15	
IEC 60870-5-104 remote control protocol - Support 2nd connection	-						●	
Nr of free tags	-						1000	
Control Station - Nb connections	-						-	
Sub-Station - Nb connections	-						5	
OPC UA Server (Micro Embedded Device Server) with security	-		●					
Nr of free tags	-		125		250		1000	
Nr of Connections	-		5				10	
min sampling rate (limit)	-		1000 ms					
OPC DA Server AE	●							
Nr of Connections	4		4				6	

(1) Using parallel protocols on the same and/or different port reduces the bandwidth and the CPU performance. Not all the limits can be achieved at the same time using all the features, it's also depending on the CPU load and the maximum memory size.

AC500-eCo

Technical data

AC500-eCo V3 CPUs

Type	PM5012-T-ETH	PM5012-R-ETH	PM5032-T-ETH	PM5032-R-ETH	PM5052-T-ETH	PM5052-R-ETH	PM5072-T-2ETH	PM5072-T-2ETHW
Ethernet-based fieldbus protocols (2)	The number of allowed variables is depending on the protocol used							
Downloadable protocols (licensed feature with runtime license per CPU):								available on one Ethernet interface, the other interface can be sometimes used as switch
Ethernet/IP Scanner communication			● (1)					● (1)
Ethernet/IP Adapter communication			● (1)					● (1)
Maximum allowed number of input/output variables for the onboard fieldbus protocol	-	-	0.5 kB / 0.5 kB					0.5 kB / 0.5 kB
IEC 61850 - MMS server Edition 1 / GOOSE communication	-	-	-	-	-	-		● / ● (1)
Maximum number of allowed data attributes in variables list	-	-	-	-	-	-		1000
KNX - Building communication	-	-	-	-	-	-		● (1)
Maximum number of allowed Objects variables on the interface	-	-	-	-	-	-		1000
BACnet-BC - Infrastructure communication	-	-	-	-	-	-		● (1)
Maximum number of allowed Objects variables on the interface	-	-	-	-	-	-		1000
Diagnostic and function								
RUN/STOP switch	● (Toggle switch)							
LEDs for various status display	●							
Timer/Counter	unlimited/unlimited							
Approvals	See detailed page 284 or new.abb.com/plc							

(1) Feature is licensed, runtime license per CPU.

(2) Using parallel protocols on the same and/or different port reduces the bandwidth and the CPU performance. Not all the limits can be achieved at the same time using all the features, it's also depending on the CPU load and the maximum memory size.

AC500-eCo

Technical data

Digital S500-eCo I/O modules

Type	DI561	DI562	DI571	DI572	DO561	DO562
Supply voltage	–	–	–	–	24 V DC	24 V DC
Current consumption on UP						
Max. (without load current)	–	–	–	–	0.005 A	0.005 A
Number of channels per module						
Digital						
inputs	8	16	8 (AC)	16 (AC)	–	–
outputs	–	–	–	–	8	16
Configurable as Input or Output DC	–	–	–	–	–	–
Relay / Transistor	–	–	–	–	Transistor	Transistor
Additional configuration of channels as:						
Fast Counter	no				not applicable	
Digital inputs						
Input signal voltage	24 V AC / DC	24 V AC / DC	100-240 V AC	100-240 V AC	–	–
Input time delay	typically 8 ms	typically 8 ms	typically 15 ms / 30 ms	typically 15 ms / 30 ms	–	–
Input current per channel						
At Input voltage						
24 V AC / DC	typically 5 mA	typically 5 mA	–	–	–	–
5 V AC / DC	typically 1 mA	typically 1 mA	–	–	–	–
14 V AC	typically 2.7 mA	typically 2.7 mA	–	–	–	–
15 V DC	> 2.5 mA	> 2.5 mA	–	–	–	–
27 V AC	typically 5.5 mA	typically 5.5 mA	–	–	–	–
30 V DC	< 8 mA	< 8 mA	–	–	–	–
40 V AC	–	–	< 3 mA	< 3 mA	–	–
164 V AC	–	–	> 6 mA	> 6 mA	–	–
Output current						
Nominal current per channel	–	–	–	–	0.5 A	
Maximum (total current of all channels)	–	–	–	–	4 A	8 A
Residual current at signal state 0	–	–	–	–	< 0.5 mA	
Demagnetization when switching off inductive loads	–	–	–	–	must be provided externally	
Switching frequency						
For resistive load	–	–	–	–	limited by CPU cycle time	
For inductive load	–	–	–	–	max. 0.5 Hz	
For lamp load	–	–	–	–	max. 11 Hz at max. 5 W	
Short circuit / overload proofness	–	–	–	–	no	
Overload indication (I > 0.7 A)	–	–	–	–	no	
Output current limiting	–	–	–	–	no	
Resistance against reverse feeding of 24 V signals	–	–	–	–	no	
Contact rating						
For resistive load, max.	–	–	–	–	–	–
For inductive load, max.	–	–	–	–	–	–
For lamp load	–	–	–	–	–	–
Lifetime (switching cycles)						
Mechanical lifetime	–	–	–	–	–	–
Lifetime under load	–	–	–	–	–	–
Maximum cable length for connected process signals						
Cable						
shielded	500 m					
unshielded	300 m				150 m	
Potential isolation						
Per module	●	●	●	●	●	●
Between the channels						
input	–	per group of 8	●	per group of 8	–	–
output	–	–	–	–	–	–
Voltage supply for the module's logic	internal via I/O bus					
Fieldbus connection						
Suitable communication interface module	CI501-PNIO, CI502-PNIO, CI504-PNIO, CI506-PNIO, CI511-ETHCAT, CI512-ETHCAT, CI541-DP, CI542-DP, CI581-CN, CI582-CN, DC551-CS31, CI592-CS31, CI521-MODTCP, CI522-MODTCP					

AC500-eCo

Technical data

Digital I/O option board modules

Type	TA5101-4DI(W) (1)	TA5105-4DOT(W) (1)	TA5110-2DI2DOT(W) (1)
Supply voltage	–	24 V DC	24 V DC
Current consumption on UP			
Max. (without load current)	–	0.002 A	0.002 A
Number of channels per module			
Digital			
inputs	4	–	2
outputs	–	4	2
Configurable as Input or Output DC	–	–	–
Relay / Transistor	–	Transistor	Transistor
Additional configuration of channels as:			
Fast Counter	no	no	no
Digital inputs			
Input signal voltage	24 V DC	–	24 V DC
Input time delay	typically 4...8 ms	–	typically 4...8 ms
Input current per channel			
At Input voltage	24 V DC	typically 5 mA	–
	5 V DC	typically 1 mA	–
	15 V DC	> 2.5 mA	–
	30 V DC	< 7 mA	–
			typically 5 mA
			typically 1 mA
			> 2.5 mA
			< 7 mA
Output current			
Nominal current per channel	–	0.5 A	0.5 A
Maximum (total current of all channels)	–	2 A	1 A
Residual current at signal state 0	–	< 0.5 mA	
Demagnetization when switching off inductive loads	–	must be provided externally	must be provided externally
Switching frequency			
For resistive load	–	limited by CPU cycle time	limited by CPU cycle time
For inductive load	–	max. 0.5 Hz	max. 0.5 Hz
For lamp load	–	max. 11 Hz at max. 5 W	max. 11 Hz at max. 5 W
Short circuit / overload proofness	–	no	no
Overload indication (I > 0.7 A)	–	no	no
Output current limiting	–	no	no
Resistance against reverse feeding of 24 V signals	–	no	no
Contact rating			
For resistive load, max.	–	–	–
For inductive load, max.	–	–	–
For lamp load	–	–	–
Lifetime (switching cycles)			
Mechanical lifetime	–	–	–
Lifetime under load	–	–	–
Maximum cable length for connected process signals			
Cable			
shielded	500 m		
unshielded	300 m	150 m	150 m
Potential isolation			
Per module	● Use a separated power supply for the process voltage UP/ZP for isolation of the channels against CPU power supply		
Between the channels			
input	per group of 4	–	per group of 2
output	–	per group of 4	per group of 2
Voltage supply for the module's logic	Internal via option board bus partly, mostly by external process supply (UP/ZP), when the supply voltage is not present, the option board doesn't function.		

(1) In preparation

AC500-eCo

Technical data

Analog I/O option board modules

Type	TA5120-2AI-UI(W) (1)	TA5122-2AI-TC(W) (1)(2)	TA5123-2AI-RTD(W)	TA5126-2AO-UI(W)	TA5128-2AI1AO(W) (1)(2)
Supply voltage	24 V DC				
Current consumption on UP					
Max. (without load current)	0.050 A	0.050 A	0.050 A	0.070 A	0.070 A
Number of channels per module					
Analog					
inputs	2	2	2	–	2
outputs	–	–	–	2	1
Inputs, individually configurable					
0...10 V	12 bits	●	–	–	● (10 bits)
0...20 mA, 4...20 mA	12 bits	●	–	–	● (10 bits)
RTD	16 bits including sign	–	●	–	–
Pt100	-50...+400 °C (2/3-wire)	–	–	●	–
Pt1000	-50...+400 °C (2/3-wire)	–	–	●	–
Ni100 / Ni1000	-50...+150 °C (2/3-wire)	–	–	●	–
Resistor	0...150 Ω	–	–	●	–
NTC 10K, NTC 20K	-40...+110 °C	–	–	●	–
Thermocouple	Types J, K, T, N, S, E, R	–	●	–	–
Resolution of temperature measurement	0.1 °C	–	–	●	–
Outputs, individually configurable					
0...+10 V	12 bits	–	–	–	● (10 bits)
0...20 mA	12 bits	–	–	–	● (10 bits)
4...20 mA	12 bits	–	–	–	● (10 bits)
Basic error at 25 °C					
Analog input	±0.3 %	±0.3 %	±0.3 %	–	±0.8 %
Analog output	–	–	–	±0.3 %	±0.8 %
Maximum error over full temperature range					
Analog input	±0.5 %	±0.3 %	±0.3 %	–	±1.5 %
Analog output	–	–	–	±0.3 %	±1.5 %
Per module	● Use a separated power supply for the process voltage UP/ZP for isolation of the channels against CPU power supply				–
Analog					
inputs	per group of 2	per group of 2	per group of 2	–	–
outputs	–	–	–	per group of 2	–
Voltage supply for the module's logic	Internal via option board bus partly, mostly by external process supply (UP/ZP), when the supply voltage is not present, the option board doesn't function.				

(1) In preparation

(2) Preliminary information

AC500-eCo

Technical data

Serial interface option board modules

Type	TA5141-RS232I(W) (1)	TA5142-RS485I(W) (1)	TA5142-RS485(W) (1)
Supply voltage	–	–	–
Current consumption on UP			
Max. (without load current)	–	–	–
Number of channels per option board module			
COMx	1	1	1
Nb of option board usable on an AC500-eCo V3 CPU	Up to 3 option boards can be used at a same time on a CPU according to their type		
Serial interface			
RS232 isolated	●	–	–
RS485 isolated	–	●	–
RS485 non isolated	–	–	●
Switchable End Of Line termination	–	●	●
Switchable line polarisation	–	●	●
Programming	–		
Modbus-RTU Master/Slave	●		
ASCII communication	●		
Terminal block	5 pole spring/cable front terminal 3.50 mm pitch, delivered with the option board		
Maximal cable length for connected interface			
Cable shielded	Information on demand		
Potential isolation			
Per module	●	●	–
Voltage supply for the module's logic	internal via option board bus		

(1) In preparation

AC500-eCo

Technical data

Digital S500-eCo I/O modules

Type	DO571	DO572	DO573
Supply voltage	24 V DC		
Current consumption on UP			
Max. (without load current)	0.050 A	–	0.050 A
Number of channels per module			
Digital			
inputs	–	–	–
outputs	8	8	16
Configurable as Input or Output DC	–	–	–
Relay / Transistor	Relay (n.o.)	Triac (AC)	Relay (n.o.)
Process voltage			
DC	24 V	–	–
Digital inputs			
Input signal voltage	–	–	–
Input time delay	–	–	–
Input current per channel			
At Input voltage			
24 V DC	–	–	–
5 V DC	–	–	–
15 V DC	–	–	–
30 V DC	–	–	–
Output current			
Nominal current per channel	2 A	0.3 A	2 A
Maximum (total current of all channels)	2 x 8 A	2.4 A	max 10 A per group (20 A per module)
Residual current at signal state 0	–	1.1 mA rms at 132 V AC and 1.8 mA rms at 264 V AC	–
Demagnetization when switching off inductive loads	must be performed externally		
Switching frequency			
For resistive load	1 Hz max.	10 Hz max.	1 Hz max.
For inductive load	–	–	–
For lamp load	1 Hz max.	10 Hz max.	1 Hz max.
Short circuit / overload proofness	no		
Overload indication (I > 0.7 A)	no		
Output current limiting	no		
Resistance against reverse feeding of 24 V signals	●	–	●
Output rating for different loads			
For resistive load, max.	2 A	0.3 A	2 A
For inductive load, max.	–	–	–
For lamp load	200 W at 230 V AC 30 W at 24 V DC	–	200 W at 230 V AC 30 W at 24 V DC
Lifetime (switching cycles)			
Mechanical lifetime	100 000	–	100 000
Lifetime under load	100 000 at rated load	–	100 000 at rated load
Maximum cable length for connected process signals			
Cable			
shielded	500 m		
unshielded	150 m		
Potential isolation			
Per module	between outputs and logic	●	between outputs and logic
Between the channels	input	–	–
output	per group of 4	●	per group of 8
Voltage supply for the module's logic	internal via I/O bus		
Fieldbus connection			
Suitable communication interface module	CI501-PNIO, CI502-PNIO, CI504-PNIO, CI506-PNIO, CI511-ETHCAT, CI512-ETHCAT, CI541-DP, CI542-DP, CI581-CN, CI582-CN, DC551-CS31, CI592-CS31, CI521-MODTCP, CI522-MODTCP		

AC500-eCo

Technical data

Digital S500-eCo I/O modules

Type	DX561	DX571	DC562
Supply voltage	24 V DC		
Current consumption on UP			
Max. (without load current)	0.005 A	0.050 A	0.010 A
Number of channels per module			
Digital			
inputs	8	8	–
outputs	8	8	–
Configurable as Input or Output DC	–	–	16
Relays / Transistor	Transistor	Relay (n.o.)	Transistor
Process voltage			
DC	24 V	24 V	24 V
Digital inputs			
Input signal voltage	24 V DC	24 V AC / DC	24 V DC
Input time delay	typically 8 ms		typically 8 ms
Input current per channel			
At Input voltage	24 V DC	typically 5 mA	typically 5 mA
	24 V AC	–	–
	5 V AC	–	–
	5 V DC	< 1 mA	typically 1 mA
	14 V AC	–	–
	27 V AC	–	–
	15 V DC	> 2.5 mA	> 2.5 mA
	30 V DC	< 6.5 mA	< 8 mA
Output current			
Nominal current per channel	0.5 A	2 A	0.5 A
Maximum (total current of all channels)	4 A	2 x 8 A	8 A
Residual current at signal state 0	< 0.5 mA	–	< 0.5 mA
Demagnetization when switching off inductive loads	must be performed externally		
Switching frequency			
For resistive load	Limited by CPU cycle time	1Hz max.	Limited by CPU cycle time
For inductive load	0.5 Hz max.	–	0.5 Hz max.
For lamp load	11 Hz max. at max. 5 W	1 Hz max.	11 Hz max. at max. 5 W
Short circuit / overload proofness	no		
Overload indication (I > 0.7 A)	no		
Output current limiting	no		
Resistance against reverse feeding of 24 V signals	no	yes	no
Output rating for different loads			
For resistive load, max.	–	2 A	–
For inductive load, max.	–	–	–
For lamp load	–	200 W at 230 V AC 30 W at 24 V DC	–
Lifetime (switching cycles)			
Mechanical lifetime	–	100 000	–
Lifetime under load	–	100 000 at rated Load DC-13 according to IEC 60947-5-1	–
Maximum cable length for connected process signals			
Cable	shielded	500 m	
	unshielded	150 m	
Potential isolation			
Per module		●	●
Between the channels	input	–	per group of 8
	output	–	per group of 4
Voltage supply for the module's logic	internal via I/O bus		
Fieldbus connection			
Suitable communication interface module	CI501-PNIO, CI502-PNIO, CI504-PNIO, CI506-PNIO, CI511-ETHCAT, CI512-ETHCAT, CI541-DP, CI542-DP, CI581-CN, CI582-CN, DC551-CS31, CI592-CS31, CI521-MODTCP, CI522-MODTCP		

AC500-eCo

Technical data

Analog S500-eCo I/O modules

Type		AI561	AO561	AX561	AI562	AI563
Supply voltage		24 V DC				
Current consumption on UP						
Max. (without load current)		0.100 A	0.100 A	0.140 A	0.040 A	0.100 A
Number of channels per module						
Analog	inputs	4	–	4	2	4
	outputs	–	2	2	–	–
Inputs, individually configurable						
-2.5...+2.5 V	12 bits including sign	●	–	●	–	–
-5...+5 V	12 bits including sign	●	–	●	–	–
-10...+10 V	12 bits including sign	–	–	–	–	–
0...5 V	12 bits	●	–	●	–	–
0...10 V	12 bits	●	–	●	–	–
0...20 mA, 4...20 mA	12 bits	●	–	●	–	–
RTD		–	–	–	2	–
Pt100	-50...+400 °C (2/3-wire)	–	–	–	●	–
Pt1000	-50...+400 °C (2/3-wire)	–	–	–	●	–
Ni100 / Ni1000	-50...+150 °C (2/3-wire)	–	–	–	●	–
Resistor	0...150 Ω/0...300 Ω	–	–	–	●	–
Thermocouple	Types J, K, T, N, S, E, R	–	–	–	–	●
Voltage	-80...+80 mV	–	–	–	–	●
Resolution of temperature measurement	0.1 °C	–	–	–	●	●
Outputs, individually configurable						
-10...+10 V	12 bits including sign	–	●	●	–	–
0...20 mA	12 bits	–	●	●	–	–
4...20 mA	12 bits	–	●	●	–	–
Potential isolation						
Per module		–	–	–	●	●
Fieldbus connection						
Suitable communication interface module		CI501-PNIO, CI502-PNIO, CI504-PNIO, CI506-PNIO, CI511-ETHCAT, CI512-ETHCAT, CI541-DP, CI542-DP, CI581-CN, CI582-CN, DC551-CS31, CI592-CS31, CI521-MODTCP, CI522-MODTCP				

AC500-eCo

Technical data

FM562 positioning module

The FM562 module contains Pulse Train Outputs for 2 axes. Profile generator for simple motion control tasks are integrated. The RS422 outputs allow a direct connection to Stepper- or Servo drives. Function blocks in PLCopen motion control style allow the integration of the module in an application. These function blocks are contained in the library PS552-MC-E. Not usable with AC500-eCo V3 or AC500 V3, only supported by V2 CPUs.

Type	FM562	
Functionality		
Number of axis	2	
Digital inputs	2 digital inputs per axis Function: for axis enable or limit switch	
Pulse outputs	Modes cw/ccw or pulse/direction Built in profile generators	
Data of the digital inputs		
Signal voltage	24 V DC	
Input current at 24 V DC	typically 5 mA	
Potential isolation	by groups of 2	
Data of pulse outputs		
Signal	RS422 (differential)	
Frequency range	0...250 kHz	
Potential isolation	RS422 outputs of both axes in one group isolated against the inputs, the process voltage and the PLC CPU logic	
Maximum cable length for digital inputs		
Cable	shielded	500 m
	unshielded	300 m
Maximum cable length for pulse outputs		
Cable	shielded	300 m
	unshielded	30 m
Process voltage UP		
Nominal voltage	24 V DC	
Current consumption on UP	typically 0.04 A	
Reverse polarity protection	●	
Potential isolation		
Per module	●	
Voltage supply for the internal logic	From UP / ZP with isolation	
Fieldbus connection		
Suitable communication interface module	CI501-PNIO, CI502-PNIO, CI504-PNIO, CI506-PNIO, CI541-DP, CI542-DP	

AC500-eCo

System data

Environmental Conditions

Process and supply voltages

24 V DC	Voltage	24 V (-15 %, +20 %)
	Protection against reverse polarity	yes
100 V...240 V AC Wide Range Supply	Voltage	100...240 V (-15 %, +10 %)
	Frequency	50/60 Hz (-6 %, +4 %)
Allowed interruptions of power supply	DC supply	Interruption < 10 ms, time between 2 interruptions > 1 s, PS2
	AC supply	Interruption < 0.5 periods, time between 2 interruptions > 1 s

Important: Exceeding the maximum process and supply voltages could lead to unrecoverable damage of the system. The system could be destroyed. For the supply of the modules, power supply units according to PELV or SELV specifications must be used. The creepage distances and clearances meet the requirements of the overvoltage category II, pollution degree 2.

Assembly position

Horizontal	•
Vertical	•

Temperature

Operating	0 °C ... +60 °C and -20 °C ... +70 °C for W version	Preferred mounting position horizontal. Other mounting positions see manual.
Storage / Transport	-40 °C ... +70 °C	

Humidity

Operating / Storage	Max 95 % r. H. without condensation
---------------------	-------------------------------------

Air pressure

Operating	-1000 m ... 2000 m (1080 hPa ... 800 hPa)
Storage	<3500 m (>660 hPa)

Electromagnetic Compatibility

Radiated emission (radio disturbances)	Yes, in accordance with CISPR 16-2-3
Conducted emission (radio disturbances)	Yes, in accordance with CISPR 16-2-1, CISPR 16-1-2
Electrostatic discharge (ESD)	Yes, in accordance with IEC 61000-4-2, zone B, criterion B Electrostatic voltage in case of air discharge: 8 kV Electrostatic voltage in case of contact discharge: 6 kV
Fast transient interference voltages (burst)	Yes, in accordance with IEC 61000-4-4, zone B, criterion B Supply voltage units (DC): 2 kV Digital inputs/outputs (24 V DC): 1 kV Digital inputs/outputs (100...240 V AC): 2 kV Analog inputs/outputs: 1 kV Communication lines shielded: 1 kV I/O supply (DC-out): 1 kV
High energy transient interference voltages (surge)	Yes, in accordance with IEC 61000-4-5, zone B, criterion B Supply voltage units (DC): 1 kV CM* / 0.5 kV DM* Digital inputs/outputs (24 V DC): 1 kV CM* / 0.5 kV DM* Digital inputs/outputs (100...240 V AC): 2 kV CM* / 1 kV DM* Analog inputs/outputs: 1 kV CM* / 0.5 kV DM* Communication lines shielded: 1 kV CM* I/O supply (DC-out): 0,5 kV CM* / 0.5 kV DM* * CM = Common Mode, * DM = Differential Mode
Influence of radiated disturbances	Yes, in accordance with IEC 61000-4-3, zone B, criterion A Test field strength: 10 V/m
Influence of line-conducted interferences	Yes, in accordance with IEC 61000-4-6, zone B, criterion A Test voltage: 10 V
Influence of power frequency magnetic fields	Yes, in accordance with IEC 61000-4-8, zone B, criterion A 30 A/m 50 Hz 30 A/m 60 Hz

WARNING!

Risk of malfunctions and damages to persons!

Unused slots for communication modules are not protected against contact discharge. Dust and Dirt may cause contact problems and malfunctions.

I/O-Bus connectors must not be touched during operation.

In order to prevent malfunctions, it is recommended that the operating personnel discharge themselves prior to touching communication connectors or perform other suitable measures to reduce effects of electrostatic discharges.

AC500-eCo

System data

Environmental Conditions

Environmental Tests

Storage	IEC 60068-2-1 Test Ab: cold withstand test -40 °C / 16 h
	IEC 60068-2-2 Test Bb: dry heat withstand test +70 °C / 16 h
Humidity	IEC 60068-2-30 Test Db: Cyclic (12 h / 12 h) Damp-Heat Test 55 °C, 93 % r. H. / 25 °C, 95 % r. H., 2 cycles
Vibration resistance	IEC 61131-2 / IEC 60068-2-6: 5 Hz ... 150 Hz, 1 g (with Memory Card inserted)
Shock resistance	IEC 60068-2-27: all 3 axes 15 g, 11 ms, half-sinusoidal

Mechanical Data

Wiring method	Spring terminals / Screw terminals	
Degree of protection	IP 20	
Assembly on DIN rail	DIN rail type	According to IEC 60715 35 mm, depth 7.5 mm or 15 mm
Assembly with screws	Screw diameter	4 mm
	Fastening torque	1.2 Nm

Main dimensions mm, inches

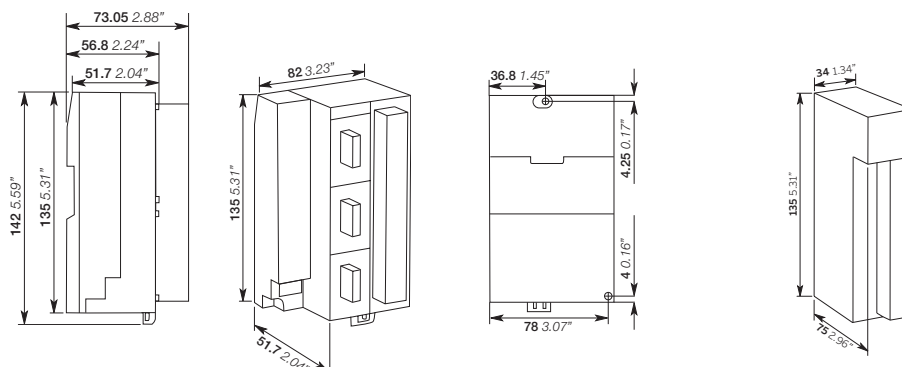

AC500

High performance
modular PLC

143	Key features
144–158	Ordering data
159–189	Technical data
190–191	System data

ABB

PM592

SYS
BATT
I/O-Bus

run

ETH
FBP
COM1
COM2

PWR



RUN



ERR



RUN

DIAG

VAL

CFG

ESC



OK



WARNING

Use of
incorrect
battery may
cause fire or
explosion.

MC
502

← INSERT
→ PUSH

UP 24VDC 10W

CPU

05

AC500

Key features



A high performance PLC:

- Large memory up to 160 MB
- Highly modular
- From 8 to +80 000 I/Os
- More communication possibilities (Ethernet, Internet, PROFINET, PROFIBUS, Modbus, CANopen, EtherCAT, Ethernet/IP, BACnet, KNX, OPC UA, OPC DA, IEC 60870-5-104, DNP3, IEC 61850, MQTT, ...)

Common AC500 platform benefits: ABB Ability™ Automation Builder engineering suite, I/O modules, scalable and flexible

- Eight programming languages available (five IEC 61131-3, CFC, C-code and C++)
- Object oriented engineering
- Virtual controller
- Web Visu
- Data logging
- Memory card for program back-up
- High Availability (HA) option
- Screw or spring terminal for I/Os
- Extensive programming libraries

AC500

Ordering data

AC500 CPUs

- 2 internal serial interfaces, RS232 / RS485 configurable
- Display and 8 function keys for diagnosis and status
- Can be centrally extended with up to 10 I/O modules, 320 I/Os (S500 and/or S500-eCo modules allowed)
- Simultaneous operation of up to 4 external communication modules in any desired combination
- Optional memory card for data storage and program backup
- Can also be used as slave on PROFIBUS DP, CANopen or PROFINET IO using CM582-DP, CM588-CN, CM589-PNIO or CM589-PNIO-4 communication modules
- Ethernet version provides web server and IEC 60870-5-104 remote control protocol
- Support of AC500-S safety PLC.

Program memory kB	Cycle time in μ s per instruction min. Bit/Word/Float. point	Integrated communication	Type	Order code	Weight (1 pce) kg
512	0.06 / 0.09 / 0.7	Ethernet (1), 2 x serial	PM573-ETH	1SAP130300R0271	0.135
512	0.05 / 0.06 / 0.5	2 x serial	PM582	1SAP140200R0201	0.134
1024	0.05 / 0.06 / 0.5	Ethernet (1), 2 x serial	PM583-ETH	1SAP140300R0271	0.134
1024	0.004 / 0.008 / 0.008	Ethernet (1), 2 x serial	PM585-ETH	1SAP140500R0271	0.137
2048	0.002 / 0.004 / 0.004	Ethernet (1), 2 x serial	PM590-ETH	1SAP150000R0271	0.137
2048	0.002 / 0.004 / 0.004	ARCNET BNC, 2 x serial	PM590-ARCNET	1SAP150000R0261	0.157
4096	0.002 / 0.004 / 0.004	Ethernet (1), 2 x serial	PM591-ETH	1SAP150100R0271	0.137
4096	0.002 / 0.004 / 0.004	2 x Ethernet (1), 1 x serial	PM591-2ETH (3)	1SAP150100R0277	0.137
4096	0.002 / 0.004 / 0.004	Ethernet (1), 2 x serial	PM592-ETH (2)	1SAP150200R0271	0.153

AC500 Machine controller kits

- One single order code for a complete product bundle providing all needed devices for a machine controller.

Program memory kB	Cycle time in μ s per instruction min. Bit/Word/Float. point	Contents / Integrated communication	Type	Order code	Weight (1 pce) kg
1024	0.004 / 0.008 / 0.008	PM585-ETH, CM579-ETHCAT, TB511-ETH Ethernet (1), 2 x serial, EtherCAT Master	PM585-MC-KIT	1SAP140500R0379	0.397
2048	0.002 / 0.004 / 0.004	PM590-ETH, CM579-ETHCAT, TB521-ETH, TA524 Ethernet (1), 2 x serial, EtherCAT Master	PM590-MC-KIT	1SAP150000R0379	0.483

(1) Provides integrated web server and IEC 60870-5-104 remote control protocol on each interface independently.

(2) Provides integrated 4 GB flash disk for user data storage and data logging.

(3) Only to be used with dedicated terminal base TB523-2ETH.



PM592



PM585-MC-KIT

AC500

Ordering data

AC500 CPU PM595

- 2 Ethernet interfaces with integrated switch and software configurable protocol (PROFINET, EtherCAT or Ethernet e.g. Modbus TCP)
- 2 independent Ethernet interfaces for programming, online access, web server, Modbus TCP, IEC 60870-5-104 protocol e.g.
- 2 serial interfaces, RS232 / RS485 configurable
- Can be centrally extended with up to 10 I/O modules (S500 and/or S500-eCo modules allowed)
- Simultaneous operation of up to 2 external communication modules in any desired combination, no need of additional terminal base

Program memory MB	Cycle time in μ s per instruction min. Bit/Word/Float. point	Integrated communication	Type	Order code	Weight (1 pce) kg
16	0.0006/0.001/0.001	2 x Ethernet for fieldbus (2 Ports switch), 2 x Ethernet (1), 2 x serial	PM595-4ETH-F (2)	1SAP155500R0279	1.045

(1) Provides integrated web server and IEC 60870-5-104 remote control protocol on each interface independently.

(2) Provides integrated 4 GB flash disk for user data storage and data logging.



PM595-4ETH-F

AC500

Ordering data

Terminal base

- For mounting and connection of the CPUs and communication modules (not needed for PM595)
- 1 to 4 plug-in communication modules
- Connection for communication coupler integrated in the CPU
- I/O interface for direct connection of up to 10 extension modules
- Fieldbus-neutral FieldBusPlug-Slave interface (not for TB523-2ETH)
- Connection COM1: 9-pole pluggable terminal block
- Connection COM2: D-Sub 9 (not for TB523-2ETH).

Number of coupler slots	Connection for coupler integrated in the CPU	Type	Order code	Weight (1 pce) kg
1	ARCNET BNC	TB511-ARCNET (2)	1SAP111100R0260	0.161
2	ARCNET BNC	TB521-ARCNET (2)	1SAP112100R0260	0.187
1	Ethernet RJ45	TB511-ETH	1SAP111100R0270	0.159
2	Ethernet RJ45	TB521-ETH	1SAP112100R0270	0.186
2	2x Ethernet RJ45	TB523-2ETH (1)	1SAP112300R0277	0.173
4	Ethernet RJ45	TB541-ETH	1SAP114100R0270	0.240

Note: These TBs are compatible with previous AC500 CPU versions (R01xx) and new ones (R02xx).

(1) Can only be used together the PM591-2ETH.

(2) Can be only used with PM590-ARCNET CPU.



TB511-ETH



TB541-ETH

AC500

Ordering data

AC500 Condition Monitoring CMS

- PLC integrated condition monitoring and fast protection for high frequency signals (vibration, current, voltage, speed/encoder)
- FM502-CMS module needs function module terminal base TF5x1 for direct interfacing to CPU, communication couplers, other I/O
 - for stand-alone or control/safety integrated condition monitoring
- PM592 CPU to be used on same TF5x1 for data storage and signal processing or communication
 - C-code interface for own complex diagnosis algorithms, 4GB Flash disk for raw fingerprints and indicator trending
- FM502-CMS module:
 - 16 fast, precise analog inputs, all synchronously sampled; configurable as IEPE or +-10V
 - individual measurement configuration (start,stop,trigger) per channel
 - per channel up to 50ksamples/s and 24bit ADC resolution, adjustable sampling
 - encoder inputs (5V or 24V) up to 300kHz counter; 12 modes, incl. absolute SSI (1MHz)
 - fast data logging, compact WAV-Files delivered automatically to CPU, incl. synchronized encoder signal if configured
 - analogue values always available for fast protection in I/O image of CPU
- Included in ABB Ability™ Automation Builder: Configuration, libraries for CMS control and wav file handling, examples
- Available download package: Signal processing library, example programs with simple diagnosis, logging and automated triggering (2)

Number of coupler slots	Description	Type	Order code	Weight (1 pce) kg
n.a.	Function Module for Condition Monitoring Systems, 16AI, 2DI, 2DC, 1x Encoder (A, B, Z)	FM502-CMS	1SAP260400R0001	0.150
0	Function module terminal base for FM502, no coupler slots, 1x ETHERNET, 1x serial, spring terminals, 24 V DC	TF501-CMS (1)	1SAP117000R0271	0.325
2	Function module terminal base for FM502, 2x coupler slots, 1x ETHERNET, 1x serial, spring terminals, 24 V DC	TF521-CMS (1)	1SAP117200R0271	0.400

(1) Can only be used together with FM502 and PM592-ETH

(2) Download of Package under "Application Examples" at new.abb.com/plc



FM502-CMS



TF501-CMS



TF521-CMS

AC500

Ordering data

AC500 V3 CPUs

- 1x internal serial interface, RS232 / RS485 configurable (ACSII or Modbus RTU Master/Slave)
- 2x independent Ethernet interfaces which can also be used as switch and software configurable protocols like Modbus TCP, IEC 60870-5-104, Ethernet/IP (3), IEC 61850 (3), BACnet-BC (3) or KNX IP (3) controller
- Web server with Web Visu HTML5 with CP600 with web interface
- 1x internal CAN interface, with CANopen Master, CAN 2A/2B and J1939 protocols
- Display and 8 function keys for diagnosis and status
- Can be centrally extended with up to 10 I/O modules, 320 I/Os (S500 and/or S500-eCo modules allowed)
- Simultaneous operation of several external communication modules in any desired combination
- To be used exclusively with new TB56xx-2ETH
- Optional memory card for data storage and program backup
- To be used only with ABB Ability™ Automation Builder 2.1 and later
- Support of AC500-S safety PLC

Total user program memory MB (4)(5)	Cycle time in μ s per instruction min. Bit/Word/Float. point	Integrated communication	Type	Order code	Weight (1 pce) kg
8 (thereof 2 for User Prog. code + Data)	0.020 / 0.020 / 0.120	2 x Ethernet with configurable protocol Ethernet/IP (2), 1 x serial, 1x CAN interface	PM5630-2ETH (1) (3)	1SAP131000R0278	0.133
80 (thereof 8 for User Prog. code + Data)	0.010 / 0.010 / 0.010	2 x Ethernet with configurable protocols Ethernet/IP (2), 1 x serial, 1x CAN interface	PM5650-2ETH (1) (3)	1SAP141000R0278	0.133
160 (thereof 32 for User Prog. code + Data)	0.002 / 0.002 / 0.002	2 x Ethernet with configurable protocol Ethernet/IP (2), 1 x serial, 1x CAN interface	PM5670-2ETH (1) (3)	1SAP151000R0278	0.133
160 (thereof 32 for Prog. code + Data) / 8GB Flash disk	0.002 / 0.002 / 0.002	2 x Ethernet with configurable protocol Ethernet/IP (2), 1 x serial, 1x CAN interface	PM5675-2ETH (1) (3)	1SAP151500R0278	0.135

(1) Ethernet communication provides integrated web server, IEC 60870-5-104 remote control protocol and OPC UA server on each interface independently.

(2) Some communication protocols are licensed see following lines. (3) Only to be used with dedicated terminal base TB56xx-2ETH.

(4) Memory size of V2 versus V3 CPUs is not comparable. Projects have a different and separate User Program code and Data memory calculation in Automation Builder 2.4.0 version or later. System, configuration and web server parts are not counted anymore. This results in typically about 50% lower memory usage compared to V2, and even lower memory usage compared to V3 projects compiled in Automation Builder 2.3.0 or before.

(5) Total user program memory: Defines the CPU type and the size of User part but the most relevant and real information is given by the maximum downloadable application size of each CPU (see technical data).



PM5630-2ETH



PM5650-2ETH



PM5670-2ETH



PM5675-2ETH



PM5650-MC-KIT

AC500 Machine controller kits

- One single order code for a complete product bundle providing all needed devices for a machine controller.

Program memory kB	Cycle time in μ s per instruction min. Bit/Word/Float. point	Features	Axis limits EtherCAT axis per ms cycle time	Max. axis at 2 ms EtherCAT cycle time	Type	Order code	Weight (1 pce) kg
8 MB	0.020 / 0.020 / 0.120	PM5630-2ETH, CM579-ETHCAT, TB5610-ETH, PS5611-MC	2	4	PM5630-MC-KIT	1SAP131000R0379	0.363
80 MB	0.010 / 0.010 / 0.010	PM5650-2ETH, CM579-ETHCAT, TB5610-ETH, PS5611-MC	8	16	PM5650-MC-KIT	1SAP141000R0379	0.363
160 MB	0.002 / 0.002 / 0.002	PM5670-2ETH, CM579-ETHCAT, TB5610-ETH, PS5611-MC	16	32	PM5670-MC-KIT	1SAP151000R0379	0.363

AC500

Ordering data

AC500 Runtime Licenses

For	Description	Type	Order code
all AC500 CPUs	Modbus TCP HA runtime license	PS5601-HA-MTCP	1SAP195400R0101
all AC500 V3 CPUs	IEC 61850 protocol runtime license (1)	PS5602-61850	1SAP195600R0101
all AC500 V3 CPUs	KNX IP protocol runtime license (1)	PS5604-KNX	1SAP195800R0101
all AC500 V3 CPUs	BACnet protocol B-BC runtime license (1)	PS5607-BACnet-BC	1SAP195550R0101
all AC500 V3 CPUs	Data logger runtime license for AC500 V3	PS5609-Log	1SAP195002R0101
PM5072	Data logger runtime license for PM5072	PS5609-Log-e	1SAP195004R0101
all AC500 V3 CPUs	Motion control library runtime license (1)	PS5611-MC	1SAP192150R0101
AC500 V3/AC500-eCo V3	Ethernet/IP scanner runtime license for AC500 V3 (for PM5032, PM5052, PM5072 and PM56xx)	PS5613-EIP-S	1SAP196101R0101
AC500-eCo V3	Ethernet/IP scanner runtime license for AC500-eCo V3 (for PM5032, PM5052 and PM5072)	PS5613-EIP-S-e	1SAP196103R0101
AC500 V3/AC500-eCo V3	Ethernet/IP adapter runtime license for AC500 V3 (for PM5032, PM5052, PM5072 and PM56xx)	PS5613-EIP-A	1SAP196100R0101
AC500-eCo V3	Ethernet/IP adapter runtime license for AC500-eCo V3 (for PM5032, PM5052 and PM5072)	PS5613-EIP-A-e	1SAP196102R0101

For using runtime licensed features one license per CPU is required. The license has to be installed on the AC500 V3 CPU either by connecting it to Automation Builder or via Memory card that has been prepared by Automation Builder for license activation.
The licenses can be transferred between AC500 V3 CPUs unlimited times.

(1) Also available for AC500-eCo V3 PM5072.

AC500

Ordering data

AC500 V3 Terminal base

- For mounting and connection of the AC500 V3 CPUs only and communication modules
- 0, 1, 2, 4 or up to 6 plug-in communication modules
- Connection for communication coupler integrated in the CPU
- I/O interface for direct connection of up to 10 extension modules
- Connection COM1: 9-pole pluggable spring terminal block
- Connection CAN: 2x 5-pole pluggable spring terminal block
- 2x RJ45 Ethernet interfaces with configurable switch functionality

Number of coupler slots	Connection for coupler integrated in the CPU	Type	Order code	Weight (1 pce) kg
0	2x RJ45 for Ethernet, 1x serial COM1 with pluggable spring connector and 1x2x5 poles pluggable spring connector for CAN/CANopen interface	TB5600-2ETH	1SAP110300R0278	0.129
1		TB5610-2ETH	1SAP111300R0278	0.157
2		TB5620-2ETH	1SAP112300R0278	0.185
4		TB5640-2ETH	1SAP114300R0278	0.236
6		TB5660-2ETH	1SAP116300R0278	0.310



TB5600-2ETH



TB5610-2ETH



TB5620-2ETH



TB5640-2ETH



TB5660-2ETH

Terminal base compatibility

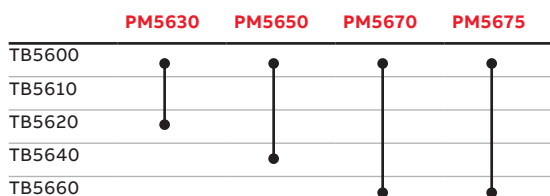

AC500

Ordering data

Communication modules

Protocol	Connections	CPU V3 Support	Type	Order code	Weight (1 pce) kg
PROFIBUS DP V0/V1 master	D-Sub 9	Yes	CM592-DP	1SAP173200R0001	0.092
PROFIBUS DP V0/V1 slave	D-Sub 9	Yes	CM582-DP	1SAP172200R0001	0.094
Ethernet (TCP/IP, UDP/IP, Modbus TCP)	2 x RJ45 - integrated switch	-	CM597-ETH	1SAP173700R0001	0.101
Ethernet interface extender (3) (TCP/IP, Modbus TCP, OPC UA)	2 x RJ45 - 2 independent channels	(2)	CM5640-2ETH	1SAP176000R0080	0.100
CANopen master	Terminal block 2 x 5 poles spring	(1)	CM598-CN	1SAP173800R0001	0.088
CANopen slave	Terminal block 2 x 5 poles spring	-	CM588-CN	1SAP172800R0001	0.090
PROFINET IO RT controller	2 x RJ45 - integrated switch	Yes	CM579-PNIO	1SAP170901R0101	0.100
PROFINET IO RT device	2 x RJ45 - integrated switch	Yes	CM589-PNIO	1SAP172900R0011	0.100
PROFINET IO RT with 4 devices	2 x RJ45 - integrated switch	Yes	CM589-PNIO-4	1SAP172900R0111	0.100
EtherCAT master	2 x RJ45	Yes	CM579-ETHCAT	1SAP170902R0101	0.101
Serial + co-processor	2 x RS-232/485 on spring terminal blocks	-	CM574-RS	1SAP170400R0201	0.095
Serial RCOM	2 x RS-232/485 (1 x RCOM/1 x Console)	-	CM574-RCOM	1SAP170401R0201	0.095
Serial interface extender (4) (ASCII, Modbus RTU)	2 x RS-232/485 on spring terminals	(2)	CM5610-2RS	1SAP176000R0020	0.100

(1) Only with CAN 2A/2B protocol, the support CANopen Master protocol is in preparation.

(2) In preparation

(3) This communication module is a port extender for the used V3 CPU only, it adds 2 independent Ethernet channels driven by the CPU. That means the Ethernet limits of the CPU used apply for all onboard interfaces and added external interfaces (e.g. number of Modbus TCP clients of a CPU) will not be increased using the CM5640-2ETH but can then be splitted between onboard and external interfaces.

(4) This communication module is a port extender for the used V3 CPU only, it adds 2 independent serial interfaces driven by the CPU. That means the limits of the CPU used apply for all onboard interfaces and added external interfaces and can then be splitted between onboard and external interfaces.



CM592-DP



CM574-RS
CM574-RCOM



CM598-CN



CM579-PNIO



CM5640-2ETH

Protocol	Communication module	Communication interface module	I/O extension module			Applications	Support from CPU	
			S500	S500-eCo	S500-S		V2	V3
Modbus TCP	Onboard Ethernet interface	CI521-MODTCP / CI522-MODTCP	●	● (3)	-	HA, remote I/O, hot-swap I/O	●	●
	CM597-ETH		●	● (3)	-	HA, remote I/O, hot-swap I/O	●	-
	CM5640-2ETH (1)		●	● (3)	-	HA, remote I/O, hot-swap I/O	-	●
PROFIBUS DP	CM592-DP master	CI541-DP / CI542-DP	●	●	-	remote I/O	●	●
			●	-	-	hot-swap I/O	●	-
PROFINET IO RT	CM579-PNIO controller	CI501-PNIO / CI502-PNIO	●	●	●	remote I/O, safety I/O	●	●
			●	-	-	hot-swap I/O	●	●
			●	●	●	remote I/O, safety I/O	●	-
CANopen	Onboard CAN interface CM598-CN master	CI581-CN / CI582-CN	-	-	-	remote I/O	-	● (2)
			●	●	-	remote I/O	●	-
EtherCAT	CM579-ETHCAT master	CI511-ETHCAT / CI512-ETHCAT	●	●	-	remote I/O	●	●
CS31 bus	Onboard COM1 interface CM574-RS	DC505-CS31 / CI592-CS31	●	●	-	remote I/O	●	-
		CI590-CS31-HA	●	-	-	HA	●	-
		DC505-CS31 / CI592-CS31	●	●	-	remote I/O	●	-
		CI590-CS31-HA	●	-	-	HA	●	-

(1) In preparation

(2) Only support of the I/O from the CI58x module, no addition S500 I/O supported today

(3) Hot-swap I/O only for S500 I/O not S500-eCo.

AC500

Ordering data

I/O modules

- Hot swap capable when mounted on hot swap terminal unit
- For central extension of the AC500 or AC500-eCo CPUs
- For decentralized extension in combination with communication interface modules on CS31, PROFINET IO, EtherCAT, Modbus TCP, PROFIBUS DP, CANopen modules
- DC and AC: Channels can be configured individually as inputs or outputs
- Plug-in electronic modules, terminal unit required (refer to table below).

Digital I/O

Number of	Input signal	Output type	Output signal	Terminal units Screw / Spring	Type	Order code	Weight (1 pce) kg
DI/DO/DC							
32 / - / -	24 V DC	-	-	TU515 / TU516	DI524	1SAP240000R0001	0.100
- / - / 16	24 V DC	Transistor	24 V DC, 0.5 A	TU515 / TU516	DC522	1SAP240600R0001	0.102
- / - / 24	24 V DC	Transistor	24 V DC, 0.5 A	TU515 / TU516	DC523	1SAP240500R0001	0.115
16 / - / 16	24 V DC	Transistor	24 V DC, 0.5 A	TU515 / TU516	DC532	1SAP240100R0001	0.114
8 / 8 / -	24 V DC	Relay	230 V AC, 3 A (2)	TU531 / TU532	DX522	1SAP245200R0001	0.177
8 / 4 / -	230 V AC	Relay	230 V AC, 3 A (2)	TU531 / TU532	DX531	1SAP245000R0001	0.151
- / 32 / -	-	Transistor	24 V DC, 0.5 A	TU515 / TU516	DO524	1SAP240700R0001	0.106
- / 8 / -	-	Transistor	24 V DC, 2 A	TU541 / TU542	DO526	1SAP240800R0001	0.132

(2) Relay outputs, changeover contacts.



DO524

AC500

Ordering data

Analog I/O

Number of	Input signal	Output signal	Terminal units Screw / Spring	Type	Order code	Weight (1 pce) kg
AI/AO/AC						
16 / 0 / 0	0...10 V, ±10 V	–	TU515 / TU516	AI523	1SAP250300R0001	0.125
4 / 4 / 0	0/4...20 mA, PT100, PT1000, Ni1000	±10 V	TU515 / TU516	AX521	1SAP250100R0001	0.129
0 / 0 / 8 (max. 4 current outputs)		0/4...20 mA	TU515 / TU516	AC522	1SAP250500R0001	0.152
8 / 8 / 0 (max. 4 current outputs)			TU515 / TU516	AX522	1SAP250000R0001	0.151
0 / 16 / 0 (max. 8 current outputs)	–		TU515 / TU516	AO523	1SAP250200R0001	0.127
8 / 0 / 0	0...5 V, 0...10 V, ±50 mV, ±500 mV, 1 V, ±5 V, ±10 V, 0/4...20 mA, ±20 mA, PT100, PT1000, Ni1000, Cu50, 0...50 kΩ, S, T, N, K, J	–	TU515 / TU516	AI531	1SAP250600R0001	0.128

Analog/digital mixed I/O

Number of	Input signal	Output type	Output signal	Terminal unit Screw / Spring	Type	Order code	Weight (1 pce) kg
AI/AO/DI/DO/DC							
4 / 2 / 16 / - / 8	24 V DC/0...10 V, -10...+10 V, 0...20 mA, 4...20 mA, PT100, PT1000, Ni100, Ni1000	Transistor	24 V DC, 0.5 A / -10...+10 V, 0...20 mA, 4...20 mA	TU515 / TU516	DA501	1SAP250700R0001	0.121
4 / 2 / - / 16 / 8				TU515 / TU516	DA502	1SAP250800R0001	0.124

Function module

- Not hot swap capable

Functionality	Number of	Input signal	Output type	Output signal	Terminal units Screw / Spring	Type	Order code	Weight (1 pce) kg
DI/DO/DC								
Encoder and PWM module	2 / - / 8	24 V DC and 2 encoder inputs A/B/C differential	2 PWM outputs	24 V DC, 0.1 A	TU515 / TU516	CD522	1SAP260300R0001	0.124

Fast I/O module for direct mounting on the terminal base of the AC500 CPU

Functionality	Number of	Input signal	Output type	Output signal	Terminal unit	Type	Order code	Weight (1 pce) kg
DI/DO/DC								
Interrupt I/O and fast counter	- / - / 8	24 V DC	Transistor	24 V DC, 0.5 A	N/A (2)	DC541-CM (1) (3)	1SAP270000R0001	0.085

(1) Function module, refer to table on page 172 for details. Terminal block for I/O signal connection included.

(2) Occupies a communication module slot.

(3) The module is only supported by AC500 V2 CPU.



AO523



AI531



DA501



AX521



DC541-CM

AC500

Ordering data

Communication interface modules

Number of	Input signal	Output type	Output signal	Terminal units Screw / Spring	Type	Order code	Weight (1 pce) kg
AI/AO/DI/DO/DC							
For CS31-Bus							
- / - / 8 / - / 16	24 V DC	Transistor	24 V DC, 0.5 A	TU551-CS31 / TU552-CS31	DC551-CS31	1SAP220500R0001	0.120
- / - / - / - / 16	24 V DC	Transistor	24 V DC, 0.5 A	TU551-CS31 / TU552-CS31	CI590-CS31-HA	1SAP221100R0001	0.119
4 / 2 / 8 / - / 8	24 V DC/ 0...10 V, -10...+10 V, 0...20 mA, 4...20 mA, PT100, PT1000, Ni100, Ni1000	Transistor	24 V DC, 0.5 A/ -10...+10 V, 0...20 mA, 4...20 mA	TU551-CS31 / TU552-CS31	CI592-CS31	1SAP221200R0001	0.125
For PROFIBUS-DP							
4 / 2 / 8 / 8 / -	24 V DC/ 0...10 V, -10...+10 V, 0...20 mA, 4...20 mA, PT100, PT1000, Ni100, Ni1000	Transistor	24 V DC, 0.5 A/ -10...+10 V, 0...20 mA, 4...20 mA (1)	TU509/TU510/ TU517/TU518	CI541-DP	1SAP224100R0001	0.158
- / - / 8 / 8 / 8	24 V DC	Transistor	24 V DC, 0.5 A	TU509/TU510/ TU517/TU518	CI542-DP	1SAP224200R0001	0.154
For CANopen							
4 / 2 / 8 / 8 / -	24 V DC/ 0...10 V, -10...+10 V, 0...20 mA, 4...20 mA, PT100, PT1000, Ni100, Ni1000	Transistor	24 V DC, 0.5 A/ -10...+10 V, 0...20 mA, 4...20 mA	TU509/TU510/ TU517/TU518	CI581-CN	1SAP228100R0001	0.137
- / - / 8 / 8 / 8	24 V DC	Transistor	24 V DC, 0.5 A	TU509/TU510/ TU517/TU518	CI582-CN	1SAP228200R0001	0.130
For Ethernet-based protocol - EtherCAT							
4 / 2 / 8 / 8 / -	24 V DC/ 0...10 V, -10...+10 V, 0...20 mA, 4...20 mA, PT100, PT1000, Ni100, Ni1000	Transistor	24 V DC, 0.5 A / -10...+10 V, 0...20 mA, 4...20 mA	TU507-ETH / TU508-ETH	CI511-ETHCAT	1SAP220900R0001	0.138
- / - / 8 / 8 / 8	24 V DC	Transistor	24 V DC, 0.5 A	TU507-ETH / TU508-ETH	CI512-ETHCAT	1SAP221000R0001	0.138
For Ethernet-based protocol - PROFINET IO RT							
4/2/8/8/-	24 V DC/ 0...10 V, -10...+10 V, 0...20 mA, 4...20 mA, PT100, PT1000, Ni100, Ni1000	Transistor	24 V DC, 0.5 A / -10...+10 V, 0...20 mA, 4...20 mA	TU507-ETH / TU508-ETH	CI501-PNIO	1SAP220600R0001	0.136
- / - / 8 / 8 / 8	24 V DC	Transistor	24 V DC, 0.5 A	TU507-ETH / TU508-ETH	CI502-PNIO	1SAP220700R0001	0.133
For Ethernet-based protocol - Modbus TCP							
4/2/8/8/-	24 V DC/ 0...10 V, -10...+10 V, 0...20 mA, 4...20 mA, PT100, PT1000, Ni100, Ni1000	Transistor	24 V DC, 0.5 A / -10...+10 V, 0...20 mA, 4...20 mA	TU507-ETH / TU508-ETH	CI521-MODTCP	1SAP222100R0001	0.136
- / - / 8 / 8 / 8	24 V DC	Transistor	24 V DC, 0.5 A	TU507-ETH / TU508-ETH	CI522-MODTCP	1SAP222200R0001	0.133



CI541-DP



CI581-CN



CI511-ETHCAT



CI501-PNIO



CI521-MODTCP

AC500

Ordering data

Communication interface modules

From	To	Output signal	Terminal units	Type	Order code	Weight (1 pce) kg
Gateway on Ethernet-based protocol - PROFINET IO RT						
PROFINET IO	–	3 x RS232/422/485 ASCII serial interfaces	TU520-ETH	CI504-PNIO	1SAP221300R0001	0.139
PROFINET IO	1x CAN 2A/2B or CANopen Master	2 x RS232/422/485 ASCII serial interfaces	TU520-ETH	CI506-PNIO	1SAP221500R0001	0.144



—
CI504-PNIO

Hot swap terminal units

For loadless hot swapping of digital and analog extension modules, when used in configurations with communication interface modules or AC500 CPU supporting hot swap. Hot swapping of attached extension module mounted on hot swap terminal unit is supported by AC500 V3 CPU modules as of PM5630-2ETH, AC500 V2 CPU modules as of PM585-ETH, CI501-PNIO, CI502-PNIO, CI541-DP, CI542-DP, CI521-MODTCP and CI522-MODTCP. AC500-S safety I/O modules cannot be used in configurations containing hot swap terminal units. Mixed configurations of hot swap terminal units with normal terminal units for digital and analog extension modules are possible. In the installation hot swap terminal units can be identified by the word Hot Swap and a white frame around the connection terminal area.

For	Supply	Connection type	Type	Order code	Weight (1 pce) kg
I/O modules - for Hot Swap (1)	24 V DC	Spring	TU516-H	1SAP215000R0001	0.159
I/O modules AC / relay - for Hot Swap (1)	230 V AC	Spring	TU532-H	1SAP215100R0001	0.166
High current I/O module - for Hot Swap (1)	24 V DC	Spring	TU542-H	1SAP215200R0001	0.164

(1) I/O module as of index F0 needed for Hot Swap



—
TU516-H

AC500

Ordering data

Terminal units

For digital and analog extension modules and interface modules. Please note: for modules with relay outputs, terminal units for 230 V AC (TU531 / TU532) are required.

For	Supply	Connection type	Type	Order code	Weight (1 pce) kg
Ethernet communication interface modules	24 V DC	Screw	TU507-ETH	1SAP214200R0001	0.223
		Spring	TU508-ETH	1SAP214000R0001	0.168
Ethernet gateway modules	24 V DC	Spring	TU520-ETH	1SAP214400R0001	0.147
CANopen / PROFIBUS DP (1) communication interface modules	24 V DC	Screw	TU517	1SAP211400R0001	0.239
		Spring	TU518	1SAP211200R0001	0.161
PROFIBUS DP / CANopen communication interface modules	24 V DC	Screw	TU509	1SAP211000R0001	0.216
		Spring	TU510	1SAP210800R0001	0.159
I/O modules	24 V DC	Screw	TU515	1SAP212200R0001	0.232
		Spring	TU516	1SAP212000R0001	0.159
I/O modules AC / relay	230 V AC	Screw	TU531	1SAP217200R0001	0.238
		Spring	TU532	1SAP217000R0001	0.164
High current I/O module (DO526)	24 V DC	Screw	TU541	1SAP213000R0001	0.240
	24 V DC	Spring	TU542	1SAP213200R0001	0.163
CS31 interface modules	24 V DC	Screw	TU551-CS31	1SAP210600R0001	0.236
		Spring	TU552-CS31	1SAP210400R0001	0.159

(1) TU517/TU518 Terminal units can also be used with PROFIBUS DP CI54x modules up to 1 Mbit/s.



TU515



TU520-ETH



TU510



TU518



TU508-ETH

AC500

Ordering data

Terminal units compatibility

Type	For I/O modules			For communication interface modules				
	TU515 TU516 TU516-H	TU541 TU542 TU542-H	TU531 TU532 TU532-H	TU507-ETH TU508-ETH	TU509 TU510	TU517 TU518	TU520-ETH	TU551-CS31 TU552-CS31
DA501	•							
DA502	•							
DC522	•							
DC523	•							
DC532	•							
DI524	•							
DX522			•					
DX531			•					
DO524	•							
DO526		•						
CD522	• (2)							
AC522	•							
AI523	•							
AI531	•							
AO523	•							
AX521	•							
AX522	•							
DC551-CS31								•
CI590-CS31-HA								•
CI592-CS31								•
CI501-PNIO				•				
CI502-PNIO				•				
CI504-PNIO							•	
CI506-PNIO							•	
CI511-ETHCAT				•				
CI512-ETHCAT				•				
CI521-MODTCP				•				
CI522-MODTCP				•				
CI541-DP					•	• (1)		
CI542-DP					•	• (1)		
CI581-CN					•	•		
CI582-CN					•	•		

(1) Can be used with baud rate up to 1 Mbaud.

(2) CD522 cannot be used on TU516-H.

AC500

Ordering data

For	Description	Type	Order code	Weight (1 pce) kg
AC500 CPUs	Memory card for high requirements (2 GB), for long term use e.g. data logging or use in eXtreme Conditions.	MC5141	1SAP180100R0041	0.002
	Micro memory card for standard usage. 8 GB Micro memory card with adapter. (1)	MC5102	1SAP180100R0002	0.003
	Lithium battery for data buffering	TA521	1SAP180300R0001	0.009
I/O modules	Pluggable marker holder for I/O modules, packing unit incl. 10 pcs. Template available in the AC500 online help	TA523	1SAP180500R0001	0.157
AC500 CPU's, interface module, communication module and I/O modules	White labels, packing unit incl. 10 pcs.	TA525	1SAP180700R0001	0.003
Terminal base	Communication Module, blind cap	TA524	1SAP180600R0001	0.059
CPU terminal base	Accessories for screw mounting, packing unit includes 10 pcs	TA526	1SAP180800R0001	0.074
	5-pole power plug for AC500. Spare part. Can be plugged to CPU terminal base TB5x1. Packing unit includes 5 pcs	TA527	1SAP181100R0001	0.300
	9-pole COM1 plug for AC500. Spare part. Can be plugged to CPU terminal base TB5x1 or on TU520-ETH. Packing unit includes 5 pcs	TA528	1SAP181200R0001	0.400
Communication modules	9-pole spring plug for CM574-RS/RCOM. Spare part. Packing unit includes 10 pcs	TA532	1SAP182000R0001	0.400
	5-pole spring plug for CM575-DN/CM578-CN. Spare part. Packing unit includes 5 pcs	TA533	1SAP182100R0001	0.400
	2x5-pole spring plug for CM588-CN and CM598-CN. Spare part. Packing unit includes 5 pcs.	TA534	1SAP182200R0001	0.500
	10-pole spring plug for DC541-CM. Spare part. Packing unit includes 10 pcs.	TA536	1SAP183100R0001	0.500
AC500 V2 training case	PM585-ETH + TB521-ETH + CM579-PNIO + DA501 + CI502-PNIO + CP6607 + Case + 115-230 V AC power supply + Ethernet cables + demo program + memory card + simulation stand	TA515-CASE	1SAP182400R0002	6.880
AC500 V3 training case	PM5630-2ETH + TB5620-2ETH + CM579-PNIO + DA501 + CI502-PNIO + CP6607 + Case + 115-230 V AC power supply + Ethernet cables + demo program + memory card + simulation stand	TA5450-CASE	1SAP187700R0001	6.880
AC500 CPUs PM595	Protective cap, spare-parts. Packing unit includes 3 pcs	TA540	1SAP182600R0001	0.050
	Lithium battery for real-time-clock buffering	TA541	1SAP182700R0001	0.020
	Accessories for screw-mounting. Packing unit includes 20 pcs	TA543	1SAP182800R0001	0.010

(1) When used with AC500-eCo V2 CPU, the usable capacity is limited to 4 GB. For temporary use, e.g. firmware- or project download. Not to be used during vibration or shock.



MC5141



MC5102 and adapter

AC500 training case
CPU, I/Os, HMI

TA527



TA528



TA540

AC500

Technical data

AC500 CPUs

Type	PM573-ETH	PM582	PM583-ETH	PM585-ETH
Supply voltage	24 V DC			
Current consumption on 24 V DC				
Min. (module alone)	0.110 A	0.050 A	0.110 A	0.150 A
Max. (all couplers and I/Os)	0.810 A	0.750 A	0.810 A	0.850 A
Type of processor	Freescale ARM Processor 32-bit			
Processor clock frequency	50 MHz	84 MHz		400 MHz
Total RAM memory	32 MB			64 MB
Total Flash memory	16 MB			32 MB
Total user program memory (2)	2048 kB	928 kB	6144 kB	7680 kB
User program memory – Flash EPROM and RAM	512 kB	512 kB	1024 kB	1024 kB
Integrated user data memory	512 kB thereof 288 kB saved	416 kB thereof 288 kB saved	1024 kB thereof 288 kB saved	2560 kB thereof 1536 kB saved
User flash disk (data-storage, programm access or also external with FTP)	–			
Plug-in memory card	Depending on memory card used : no SD-HC card allowed, use MC5102 for standard usage or MC5141 for high requirements			
Web server's data for user RAM disk	1 024 kB	–	4 096 kB	4 096 kB
Data buffering	battery			
Real-time clock (with battery back-up)	●			
Cycle time for 1 instruction (minimum)				
Binary	0.06 µs	0.05 µs	0.05 µs	0.004 µs
Word	0.09 µs	0.06 µs	0.06 µs	0.008 µs
Floating-point	0.7 µs	0.5 µs	0.5 µs	0.008 µs
Max. number of centralized inputs/outputs				
Max. number of extension modules on I/O bus	up to max. 10 (S500 and/or S500-eCo modules allowed)			
Digital	inputs/outputs 320/320			
Analog	inputs/outputs 160/160			
Max. number of decentralized inputs/outputs	depends on the used standard fieldbus (1)			
Program execution				
Cyclical / Time controlled / Multi tasking	●/●/●			
User program protection by password	●			
Internal interfaces				
COM1				
RS232 / RS485 configurable	●			
Connection (on terminal bases or CPU module)	pluggable spring terminal block			
Programming, Modbus RTU, ASCII, CS31 master	●			
COM2				
RS232 / RS485 configurable	●			
Connection (on terminal bases or CPU module)	D-Sub 9 female			
Programming, Modbus RTU, ASCII	●			
FieldBusPlug				
Serial neutral interface	●			
Connection (on terminal bases)	M12 male, 5 pole			
Functions	programming cable UTF-21-FBP, slave communication depending on FieldBusPlug used (PROFIBUS DP, CANopen, DeviceNet)			
Ethernet				
Ethernet connection (on terminal bases)	RJ45	–	RJ45	RJ45
Ethernet functions: Programming, TCP/IP, UDP/IP, Modbus TCP, integrated Web server, IEC 60870-5-104 remote control protocol, MQTT, SNMP (simple Network Time Protocol), DHCP, FTP server HTTP, SMTP, PING	●	–	●	●
Ethernet-based fieldbus				
Ethernet connection (on CPU module)	–			
Downloadable protocols like: PROFINET IO RT Controller / EtherCAT Master	–			
CPU display	LC display and 8 function keys			
Function	RUN / STOP, status, diagnosis			
LEDs for various status display	Run, Stop, Error			
Timer/Counter	unlimited/unlimited			
Approvals	See detailed page 284 or new.abb.com/plc			

(1) e.g. CS31 fieldbus: up to 31 stations with up to 120 DIs / 120 DOs or up to 32 AIs / 32 AOs per station.

(2) Total user program memory: contains user program code, data and web server

AC500

Technical data

AC500 CPUs

Type	PM590-ETH	PM591-ETH	PM591-2ETH	PM592-ETH	PM595-4ETH-F
Supply voltage	24 V DC				
Current consumption on 24 V DC					
Min. (module alone)	0.150 A	0.150 A	0.150 A	0.150 A	0.400 A
Max. (all couplers and I/Os)	0.850 A	0.850 A	0.850 A	0.850 A	1.2 A
Type of processor	Freescale ARM Processor 32-bit				
Processor clock frequency	400 MHz				1.3 GHz
Total RAM memory	64 MB				256 MB
Total Flash memory	32 MB				64 MB
Total user program memory (3)	13316 kB	17924 kB	17924 kB	17924 kB	64 MB
User program memory – Flash EPROM and RAM	2048 kB	4096 kB	4096 kB	4096 kB	16384 kB
Integrated user data memory	3072 kB thereof 1536 kB saved	5632 kB thereof 1536 kB saved	5632 kB thereof 1536 kB saved	5632 kB thereof 1536 kB saved	16384 kB thereof 3072 kB saved
User flash disk (data-storage, programm access or also external with FTP)	-			Yes, 4 GB Flash non removable	
Plug-in memory card	Depending on memory card used: no SD-HC card allowed, use MC5102 for standard usage or MC5141 for high requirements				
Web server's data for user RAM disk	8 MB				32 MB
Data buffering	battery				
Real-time clock (with battery back-up)	●				
Cycle time for 1 instruction (minimum)					
Binary	0.002 μs	0.002 μs	0.002 μs	0.002 μs	0.0006 μs
Word	0.004 μs	0.004 μs	0.004 μs	0.004 μs	0.001 μs
Floating-point	0.004 μs	0.004 μs	0.004 μs	0.004 μs	0.001 μs
Max. number of centralized inputs/outputs					
Max. number of extension modules on I/O bus	up to max. 10 (S500 and/or S500-eCo modules allowed)				
Digital inputs/outputs	320/320				
Analog inputs/outputs	160/160				
Max. number of decentralized inputs/outputs	depends on the used standard fieldbus (1)				
Program execution					
Cyclical / Time controlled / Multi tasking	●/●/●				
User program protection by password	●				
Internal interfaces					
COM1					
RS232 / RS485 configurable	●				
Connection (on terminal bases or CPU module)	pluggable spring terminal block, use TK502 cable in accessory				
Programming, Modbus RTU, ASCII, CS31 master	●				
COM2					
RS232 / RS485 configurable	●				
Connection (on terminal bases or CPU module)	D-Sub 9 female, use TK501 cable in accessory				
Programming, Modbus RTU, ASCII	●				
FieldBusPlug					
Serial neutral interface	●				-
Connection (on terminal bases)	M12 male, 5 pole				-
Functions	programming cable UTF-21-FBP, slave communication depending on FieldBusPlug used (PROFIBUS DP, CANopen, DeviceNet)				-
Ethernet					
Ethernet connection (on terminal bases)	RJ45	RJ45	2 x RJ45	RJ45	2 x RJ45
Ethernet functions: Programming, TCP/IP, UDP/IP, Modbus TCP, integrated Web server, IEC 60870-5-104 remote control protocol, MQTT, SNTP (simple Network Time Protocol), DHCP, FTP server HTTP, SMTP, PING	●	●	●	●	●
Ethernet-based fieldbus					
Ethernet connection (on CPU module)	-				4 x RJ45 (2 x interfaces with 2-port switch)
Downloadable protocols like: PROFINET IO RT Controller / EtherCAT Master or Ethernet like Modbus TCP	-				●
CPU display	LC display and 8 function keys				
Function	RUN / STOP, status, diagnosis				RUN / STOP, status, diagnosis, RESET
LEDs for various status display	Run, Stop, Error				●
Timer/Counter	unlimited/unlimited				
Approvals	See detailed page 284 or new.abb.com/plc				

(1) e.g. CS31 fieldbus: up to 31 stations with up to 120 DIs / 120 DOs or up to 32 AIs / 32 AOs per station. (2) Availability on demand

(3) Total user program memory: contains user program code, data and web server

AC500

Technical data

AC500 V3 CPUs

Type	PM5630-2ETH	PM5650-2ETH	PM5670-2ETH	PM5675-2ETH
Supply voltage	24 V DC			
Current consumption on 24 V DC				
Min. typ. (module alone)	0.110 A	0.120 A	0.140 A	
Max. typ. (all couplers and I/Os)	0.850 A	0.900 A	0.950 A	
Type of processor	TI ARM Cortex-A9 32-bit-RISC			
Processor clock frequency	300 MHz	600 MHz	1 GHz	1 GHz
Total RAM memory	128 MB	256 MB	512 MB	512 MB
Total Flash memory	128 MB	512 MB	1024 MB	1024 MB
User program memory (1)	8 MB	80 MB	160 MB	160 MB
Maximum downloadable application size (4)	9 MB	84 MB	176 MB	176 MB
Thereof User program code and data (dynamically allocated)	2 MB (2)	8 MB (2)	32 MB (2)	32 MB (2)
Thereof User web server Data max.	6 MB	72 MB	128 MB	128 MB
User data memory saved	256 kB	256 kB	1.5 MB	1.5 MB
Thereof VAR Retain persistent	128 kB	128 kB	1024 kB	1024 kB
Thereof %M memory (e.g. Modbus register memory)	128 kB	128 kB	512 kB	512 kB
User flash disk (data-storage, programm access or also external with FTP)				8 GB Flash non removable
Plug-in memory card	Depending on memory card used: use MC5102 for standard usage or MC5141 for high requirements.			
Data buffering	battery			
Real-time clock (with battery back-up)	●			
Cycle time for 1 instruction (minimum)				
Binary	0.02 µs	0.01 µs	0.002 µs	
Word	0.03 µs	0.01 µs	0.002 µs	
Floating-point	0.12 µs	0.01 µs	0.002 µs	
Program execution				
Cyclical	●			
Minimum cycle time configurable for cyclical task	1 ms	1 ms	0.5 ms	
Time controlled	●			
Multi tasking	●			
User program protection by password	●			
Motion control with EtherCAT via CM579-ETHCAT or CAN sync onboard and PLCopen library PS5611-MC (5)				
Min. EtherCAT master cycle time	2 ms	1 ms	0.5 ms	
Number of synchronized axis (3) in 1 ms	-	8	16	
Number of synchronized axis (3) in 2 ms	4	16	32	
Number of synchronized axis (3) in 4 ms	8	32	64	

(1) Total user program memory: Defines the CPU type and the size of User part but the most relevant and real information is given by the maximum downloadable application size of each CPU.

(2) Memory size of V2 versus V3 CPUs is not comparable. Projects have a different and separate User Program code and Data memory calculation in Automation Builder 2.4.0 version or later: System, configuration and web server parts are not counted anymore. This results in typically about 50 % lower memory usage compared to V2, and even lower memory usage compared to V3 projects compiled in Automation Builder 2.3.0 or before.

(3) + 1 e.g. for virtual axis

(4) Maximum downloadable application size: contains user program code, data, web server memory, infrastructure. This is the maximum size of the application which can be downloaded into a CPU with Automation Builder. This value is displayed and splitted into different categories in the resource window of AB SW.

(5) Licensed

AC500

Technical data

AC500 V3 CPUs

Type	PM5630-2ETH	PM5650-2ETH	PM5670-2ETH	PM5675-2ETH
Communication modules and terminal bases supported				
Max. number of communication modules on terminal base TB				
TB5600-2ETH	0 slot	0 slot	0 slot	
TB5610-2ETH	1 slot	1 slot	1 slot	
TB5620-2ETH	2 slots	2 slots	2 slots	
TB5640-2ETH	-	4 slots	4 slots	
TB5660-2ETH	-	-	6 slots	
Type of safety module supported				
SM560-S - safety module	●			
SM560-S-FD-1 - safety module with F-Device functionality for 1 PROFI-safe network	●			
SM560-S-FD-4 - safety module with F-Device functionality for 1 PROFI-safe network	●			
Type of communication module supported				
Max. number of variables allowed for each communication module supported				
Input variables	4 kB		5 kB	
Output variables	4 kB		5 kB	
CM574-RS/RCOM - serial interface	-			
CM5610-2RS - serial interface	● (1)			
CM582-DP - PROFIBUS DP V0/V1 Slave	●			
CM592-DP - PROFIBUS DP V0/V1 Master	●			
CM579-ETHCAT - Master	●			
CM579-PNIO - PROFINET IO RT controller	●			
CM589-PNIO - PROFINET IO RT device	●			
CM589-PNIO-4 - PROFINET IO RT with 4 devices	●			
CM597-ETH - Ethernet interface	-			
CM5640-2ETH - 2 Ethernet interfaces (2) (3)	● (1)			
CM588-CN - CAN, CANopen Slave	-			
CM598-CN - CAN, CANopen Master	● only CAN 2A/2B today			

(1) In preparation, availability on demand

(2) Using parallel protocols on the same and/or different port reduces the bandwidth and the CPU performance

(3) The CM5640-2ETH communication module is a port extender providing 2 additional "onboard Ethernet" interfaces to the connected CPU which manages all the communication. Some of the onboard Ethernet features are available, the Ethernet limitations from the CPU will then apply in total for all the connected interfaces. The CM5640-2ETH doesn't extend the limits which remain those of the connected CPU, e.g. no increase of Ethernet sockets or number of OPC UA tags.

AC500

Technical data

AC500 V3 CPUs

Type	PM5630-2ETH	PM5650-2ETH	PM5670-2ETH	PM5675-2ETH
Max. number of centralized inputs/outputs				
Max. number of extension modules on I/O bus	up to max. 10 (S500 and/or S500-eCo I/O modules allowed)			
Digital inputs/outputs	320/320			
Analog inputs/outputs	160/160			
Max. number of decentralized inputs/outputs	depends on the used standard fieldbus (1)			
Internal interfaces for communication				
COM1				
RS232 / RS485 configurable	●			
Connection (on terminal bases or CPU module)	pluggable spring terminal block			
Modbus RTU Master/Slave, ASCII	●			
CANopen				
Serial interface	CAN serial interface			
Connection (on terminal bases)	Pluggable spring terminal block, 2x 5 poles			
Functions	CANopen® Master communication, CAN 2A/2B, J1939 protocol, CAN sync			
Max. number of variables allowed				
Input variables	2 kB	4 kB	5 kB	
Output variables	2 kB	4 kB	5 kB	
Ethernet				
Ethernet connection (on terminal bases)	2x independent Ethernet interfaces for several uses 2x RJ45 with 2x separated interfaces and MAC-Address, could be used as 2-port switch with 1x interface			
Ethernet functions (3):				
Ethernet Switch on ETH1 / ETH2	●			
Online Access, ICMP (Ping), DHCP, programming	●			
Nb of parallel connections	6	8	12	
IP configuration protocol	●			
UDP data exchange, Network variables	● / ●			
HTTP / HTTPs (integrated web server)	●			
Nb of parallel connections	4	8	12	
Web Visu for data visualisation on web server HTML5	●			
NTP (Time synchronization) Server / Client	● / ●			
FTP / FTPs server	●			
Nb of parallel connections	2	4	4	
SMTP client	●			
Socket programming	●			
Modbus TCP Client / Server				
Nr of Modbus clients ModMast in parallel on a CPU Master (Server)	30	50	120	
Nr of Modbus server in parallel (for SCADA access e.g.)	15	25	50	
IEC 60870-5-104 remote control protocol - Support 2nd connection				
Nr of free tags	1000	5000	10000	
Control Station - Nb connections	5	10	20	
Sub-Station - Nb connections	5	10	20	
OPC UA Server (Micro Embedded Device Server) with security				
Nr of free tags	3000	10000	30000	
Nr of Connections	10	20	50	
min sampling rate (limit)	500 ms	100 ms	50 ms	
OPC DA Server AE				
Nr of Connections	8	8	8	
Ethernet-based fieldbus protocols on onboard Ethernet interface (3)				
Downloadable protocols (licensed feature with runtime license per CPU):	The number of allowed variables is depending on the protocol used available on one Ethernet interface, the other interface can be sometimes used as switch			
Ethernet/IP Scanner communication	● (2)	● (2)	● (2)	
Ethernet/IP Adapter communication	● (2)	● (2)	● (2)	
Maximum allowed number of input/output variables for the onboard fieldbus protocol	0.5 kB / 0.5 kB	0.5 kB / 0.5 kB	0.5 kB / 0.5 kB	
IEC 61850 - MMS server Edition 1 / GOOSE communication	● / ● (2)	● / ● (2)	● / ● (2)	
Maximum number of allowed data attributes in variables list	1000	2000	5000	
KNX - Building communication	● (2)	● (2)	● (2)	
Maximum number of allowed Objects variables on the interface	1000	1000	1000	
BACnet-BC - Infrastructure communication	● (2)	● (2)	● (2)	
Maximum number of allowed Objects variables on the interface	1000	2000	5000	
CPU display				
Function	LC display and 8 function keys			
LEDs for various status display	RUN / STOP, status, diagnosis, settings			
Timer/Counter	unlimited/unlimited			
Approvals	See detailed page 284 or new.abb.com/plc			

(1) e.g. CANopen fieldbus: up to 127 stations with I/O from CI module only per station.

(2) Feature is licensed, runtime license per CPU.

(3) Using parallel protocols on the same and/or different port reduces the bandwidth and the CPU performance

AC500

Technical data

Digital S500 I/O modules

Type	DI524	DC522	DC523	DC532
Number of channels per module				
Digital				
inputs	32	–	–	16
outputs	–	–	–	–
Configurable channels DC (configurable as inputs or outputs)	–	16	24	16
Additional configuration of channels as				
Fast counter	configuration of max. 2 channels per module, operating modes see table on page 189			
Occupies max. 1 DO or DC when used as counter	–	●	●	●
Connection via terminal unit	●	●	●	●
Digital inputs				
Input signal voltage	24 V DC			
Input characteristic acc. to EN 61132-2	Type 1			
0 signal	-3...+5 V DC			
Undefined signal state	5...15 V DC			
1 signal	15...30 V DC			
Input time delay (0 -> 1 or 1 -> 0)	8 ms typically, configurable from 0.1 up to 32 ms			
Input current per channel				
At input voltage	24 V DC 5 mA typically			
	5 V DC > 1 mA			
	15 V DC > 5 mA			
	30 V DC < 8 mA			
Digital outputs				
Transistor outputs 24 V DC, 0.5 A	–	●	●	●
Readback of output	–	●	●	●
Switching of load 24 V	–	●	●	●
Output voltage at signal state 1	–	process voltage UP minus 0.8 V		
Output current				
Nominal current per channel	–	0.5 A		
Maximum (total current of all channels)	–	8 A		
Residual current at signal state 0	–	< 0.5 mA		
Demagnetization when switching off inductive loads	–	by internal varistors		
Switching frequency				
For inductive load	–	0.5 Hz max.		
For lamp load	–	11 Hz max. at max. 5 W		
Short-circuit / overload proofness	–	●	●	●
Overload indication (I > 0.7 A)	–	after approx. 100 ms		
Output current limiting	–	yes, with automatic reclosure		
Proofness against reverse feeding of 24 V signals	–	●	●	●
Process voltage UP				
Nominal voltage	24 V DC			
Current consumption on UP				
Min. (module alone)	0.150 A	0.100 A	0.150 A	
Max. (min. + loads)	0.150 A	0.100 A + load	0.150 A + load	
Reverse polarity protection	●	●	●	●
Fuse for process voltage UP	10 A fast acting fuse			
Connections for sensor voltage supply. Terminal 24 V and 0 V for each connection. Permitted load for each group of 4 or 8 connections: 0.5 A	–	8	4	–
Short-circuit and overload proof 24 V DC sensor supply voltage	–	●	●	–
Maximum cable length for connected process signals				
Cable	shielded	1000 m		
	unshielded	600 m		
Potential isolation				
Per module	●	●	●	●
Between channels	input	–	–	–
	output	–	–	–
Voltage supply for the module	internally via extension bus interface (I/O bus)			
Fieldbus connection	via AC500 CPU or all communication interface modules			
Address setting	automatically (internal)			

AC500

Technical data

Digital S500 I/O modules

Type		DX522	DX531	DO524	DO526
Number of channels per module					
Digital	inputs	8	8	–	–
	outputs	8 relays	4 relays	32	8
Configurable channels DC (configurable as inputs or outputs)		–	–	–	–
Additional configuration of channels as					
Fast counter		configuration of max. 2 channels per module, operating modes see page 189	–	–	–
Occupies max. 1 DO or DC when used as counter		–	–	–	–
Connection via terminal unit		●	●	●	●
Digital inputs					
Input signal voltage		24 V DC	230 V AC or 120 V AC	–	–
Frequency range		–	47...63 Hz	–	–
Input characteristic acc. to EN 61132-2		Type 1	Type 2	–	–
0 signal		-3...+5 V DC	0...40 V AC	–	–
Undefined signal state		5...15 V DC	> 40 V AC...< 74 V AC	–	–
1 signal		15...30 V DC	74...265 V AC	–	–
Input time delay (0 -> 1 or 1 -> 0)		8 ms typically, configurable from 0.1 up to 32 ms	20 ms typically	–	–
Input current per channel					
At input voltage		24 V DC	5 mA typically	–	–
		5 V DC	> 1 mA	–	–
		15 V DC	> 5 mA	–	–
		30 V DC	< 8 mA	–	–
		40 V AC	–	< 5 mA	–
		74 V AC	–	> 6 mA	–
Digital outputs					
Transistor outputs 24 V DC		–	–	●	●
Readback output		–	–	–	–
Relay outputs, supplied via process voltage UP, changeover contacts		●	●	–	–
Switching of load		24 V	●	●	●
		230 V	●	●	–
Output voltage at signal state 1		–	–	process voltage UP minus 0.8 V	process voltage UP minus 0.4 V
Output current					
Nominal current per channel		–	–	0.5 A	2 A
Maximum (total current of all channels)		–	–	8 A	16 A
Residual current at signal state 0		–	–	< 0.5 mA	< 0.1 mA
Demagnetization when switching off inductive loads		–	–	yes	yes
Switching frequency					
For inductive load		2 Hz		0.5 Hz max.	2 Hz max.
For lamp load		11 Hz max. at max. 5 W		–	11 Hz max. 48 W
Short-circuit / overload proofness		by external fuse / circuit breaker. 6 A gL/gG per channel		●	by external fuse 10A fast
Overload indication (I > 0.7 A)		–		after approx. 100 ms	–
Output current limiting		–		yes, with automatic reclosure	–
Resistance against reverse feeding of 24 V signals		–		●	●

AC500

Technical data

Digital S500 I/O modules

Type	DX522	DX531	DO524	DO526
Contact rating				
For resistive load, max.	3 A at 230 V AC 2 A at 24 V DC		–	–
For inductive load, max.	1.5 A at 230 V AC 1.5 A at 24 V DC		–	–
For lamp load	60 W at 230 V AC 10 W at 24 V DC		–	–
Lifetime (switching cycles)				
Mechanical lifetime	300 000		–	–
Lifetime under load (DC13)	300 000 at 24 V DC / 2 A 200 000 at 120 V AC / 2 A 100 000 at 230 V AC / 3 A		–	–
Spark suppression for inductive AC load	external measure depending on the switched load		–	–
Demagnetization for inductive DC load	external measure: free-wheeling diode connected in parallel to the load		–	–
Process voltage UP				
Nominal voltage	24 V DC			
Current consumption on UP				
Min. (module alone)	0.050 A	0.150 A	0.050 A	0.050 A
Max. (module + loads)	0.050 A + load	0.150 A + load	0.100 A + load	0.100 A + load
Reverse polarity protection	●	●	●	●
Fuse for process voltage UP	10 A			
Maximum cable length for connected process signals				
Cable	shielded	1000 m		
	unshielded	600 m		
Potential isolation				
Per module	●	●	●	●
Between the channels	input	–	● (per 2)	–
	output	●	●	–
Voltage supply for the module	internally via extension bus interface (I/O bus)			
Fieldbus connection	via AC500 CPU or all communication interface modules			
Address setting	automatically (internal)			

AC500

Technical data

Analog S500 I/O modules

Type		AX521	AX522	AC522	AI523	AO523	AI531	
Number of channels per module								
Individual configuration, analog	inputs	4	8	–	16	–	8	
	outputs	4	8	–	–	16	–	
	configurable	–	–	8	–	–	–	
Signal resolution for channel configuration								
-10...+10 V		13 bits including sign						16 bits including sign
0...10 V		12 bits						15 bits
0...20 mA, 4...20 mA		12 bits						15 bits
Temperature: 0.1 °C		•	•	•	•	–	0.1/0.01	
Monitoring configuration per channel								
Plausibility monitoring		•	•	•	•	•	•	
Wire break & short-circuit monitoring		•	•	•	•	•	•	
Analog Inputs AI								
Signal configuration per AI		max. number per module and with regard to the configuration: AIs / Measuring points (depending on the use of 2/3-wire connection or differential input)						
-50...+50 mV, -500...+500 mV, -1...+1 V, -5...+5 V, 0...+5 V		–	–	–	–	–	8 / 8	
0...10 V		4 / 4	8 / 8	8 / 8	16 / 16	–	8 / 8	
-10...+10 V		4 / 4	8 / 8	8 / 8	16 / 16	–	8 / 8	
0...20 mA		4 / 4	8 / 8	8 / 8	16 / 16	–	8 / 8	
4...20 mA		4 / 4	8 / 8	8 / 8	16 / 16	–	8 / 8	
-20...+20 mA		–	–	–	–	–	8 / 8	
Pt100								
-50...+400 °C (2-wire)		4 / 4	8 / 8	8 / 8	16 / 16	–	8 / 8	
-50...+400 °C (3-wire), 2 channels		4 / 2	8 / 4	8 / 4	16 / 8	–	8 / 8	
-50...+400 °C (4-wire)		–	–	–	–	–	8 / 8	
-50...+70 °C (2-wire)		4 / 4	8 / 8	8 / 8	16 / 16	–	8 / 8	
-50...+70 °C (3-wire), 2 channels		4 / 2	8 / 4	8 / 4	16 / 8	–	8 / 8	
-50...+70 °C (4-wire)		–	–	–	–	–	8 / 8	
Pt1000								
-50...+400 °C (2-wire)		4 / 4	8 / 8	8 / 8	16 / 16	–	8 / 8	
-50...+400 °C (3-wire), 2 channels		4 / 2	8 / 4	8 / 4	16 / 8	–	8 / 8	
-50...+400 °C (4-wire)		–	–	–	–	–	8 / 8	
Ni1000								
-50...+150 °C (2-wire)		4 / 4	8 / 8	8 / 8	16 / 16	–	8 / 8	
-50...+150 °C (3-wire), 2 channels		4 / 2	8 / 4	8 / 4	16 / 8	–	8 / 8	
-50...+150 °C (4-wire)		–	–	–	–	–	8 / 8	
Cu50 -200...+200 °C		–	–	–	–	–	8 / 8	
Resistor 0...50 kΩ		–	–	–	–	–	8 / 8	
Thermocouples of types J, K, T, N, S		–	–	–	–	–	8 / 8	
0...10 V using differential inputs, 2 channels		4 / 2	8 / 4	8 / 4	16 / 8	–	8 / 8	
-10...+10 V using differential inputs, 2 channels		4 / 2	8 / 4	8 / 4	16 / 8	–	8 / 8	
Digital signals (digital input)		4 / 4	8 / 8	8 / 8	16 / 16	–	8 / 8	
Input resistance per channel		voltage: > 100 kΩ current: approx. 330 Ω				–	voltage: > 100 kΩ current: approx. 330 Ω	
Time constant of the input filter		voltage: 100 μs current: 100 μs				–	voltage: 100 μs current: 100 μs	
Conversion cycle		2 ms (for 8 AI + 8 AO), 1 s for Pt100/1000, Ni1000				–	1 ms 1 s for Pt100/1000, Ni1000	
Overvoltage protection		•	•	•	•	–	•	

AC500

Technical data

Analog S500 I/O modules

Type		AX521	AX522	AC522	AI523	AO523	AI531	
Data when using the AI as digital input								
Input	time delay	8 ms typically, configurable from 0.1 up to 32 ms				–	8 ms typically, configurable from 0.1 up to 32 ms	
	signal voltage	24 V DC				–	24 V DC	
Signal	0	-30...+5 V				–	-30...+5 V	
	1	13...30 V				–	13...30 V	
Analog outputs AO								
Possible configuration per AO		Max. number of AOs per module and with regard to the configuration:						
	-10...+10 V	4	8	8	–	16	–	
	0...20 mA	4	4	4	–	8	–	
	4...20 mA	4	4	4	–	8	–	
Output	resistance (burden) when used as current output	0...500 Ω				–	0...500 Ω	–
	loading capability when used as voltage output	Max. ±10 mA				–	Max. ±10 mA	–
Full scale conversion error								
Basic error at 25 °C								
	Analog input	±0.5 %				–	±0.1 % (voltage) ±0.3 % (current, resistor)	
	Analog output	±0.5 %				–	±0.5 %	–
Maximum error over the full range								
	Analog input	±1 %				–	±0.7 % (voltage) ±0.9 % (current, resistor)	
	Analog output	±1 %				–	±1 %	–
Process voltage UP								
Nominal voltage		24 V DC						
Current consumption on UP								
	Min. (module alone)	0.150 A				–	0.130 A	
	Max. (min. + loads)	0.150 A + load	0.150 A + load	–	–	0.150 A + load	–	
Reverse polarity protection		•	•	•	•	•	•	
Max. line length of the analog lines, conductor cross section > 0.14 mm ²		100 m						
Potential isolation								
Per module		•	•	•	•	•	–	
Fieldbus connection		Via AC500 CPU or all communication interface modules						
Voltage supply for the module		Internally via extension bus interface (I/O bus)						

(1) Half can be used on current (the other half remains available).

AC500

Technical data

CD522 encoder module

The CD522 module offers accuracy and dynamic flexibility for a customized solution. It has two independent encoder inputs onboard and is easily configured using the Automation Builder software for 10 different operation modes and for frequencies up to 300 kHz. The CD522 module also integrates outputs for pulses and for PWM as well as normal inputs and outputs, depending on selected encoder mode.

Type		CD522
Functionality		
Digital inputs/outputs		24 V DC, dedicated inputs/outputs can be used for specific counting functions. All unused inputs/outputs can be used as input/output with standard specification.
	Input options	Catch/Touch operation, counter value stored in separate variable on external event (rising or falling) Set to preset counter register with predefined value Set to reset counter register
	End value output	Output set when predefined value is reached
	Reference point initialization (RPI) input for relative encoder initialization	●
High-speed counter/encoder		
Integrated counters	Counter characteristics	2 counters (24 V DC, 5 V DC, differential and 1 Vpp sinus input)
	Counter mode	one 32 bits or two 16 bits
	Relative position encoder	X1, X2, X4
	Absolute SSI encoder	●
	Time frequency meter	●
	Frequency input	up to 300 kHz
PWM/pulse outputs		
Output mode specification	Number of outputs	2
	Push pull output	24 V DC, 100 mA max
	Current limitation	Thermal and overcurrent
PWM mode specification	Frequency	1...100 kHz
	Value	0...100 %
Pulse mode specification	Frequency	1...15 kHz
	Pulse emission	1...65535 pulses
	Number of pulses emitted indicator	0...100 %
Frequency mode specification	Frequency output	100 kHz
	Duty Cycle	Set to 50 %
Number of channels per module		
Digital	input	2
	output	2
Configurable channels DC (configurable as inputs or outputs)		8
Additional configuration of channels as		
Fast counter		Integrated 2 counter encoders
Connection via terminal unit		●
Digital Inputs		
Input	signal voltage	24 V DC
	time delay	8 ms typically configurable from 0.1 up to 32 ms
Input current per channel		
At input voltage	24 V DC	Typically 5 mA
	5 V DC	> 1 mA
	15 V DC	> 5 mA
	30 V DC	< 8 mA
Digital outputs		
Output voltage at signal state 1		UP – 0.8 V

AC500

Technical data

CD522 encoder module

Type	CD522	
Output current		
Nominal current per channel	0.5 A	
Maximum (total current of all channels)	8 A	
Residual current at signal state 0	< 0.5 mA	
Demagnetization when switching off inductive loads	By internal varistors	
Switching frequency		
For inductive load	Max. 0.5 Hz	
For lamp load	Max. 11 Hz with max. 5 W	
Short-circuit / Overload proofness	•	
Overload indication ($I > 0.7 \text{ A}$)	After approx. 100 ms	
Output current limiting	•	
Proofness against reverse feeding of 24 V signals	•	
Maximum cable length for connected process signals		
Cable	shielded	1000 m
	unshielded	600 m
Potential isolation		
Per module	•	
Technical data of the high-speed inputs		
Number of channels per module	6	
Input type	24 V DC, 5 V DC / Differential / Sinus 1 Vpp	
Frequency	300 kHz	
Technical data of the fast outputs		
Number of channels	2	
Indication of the output signals	Brightness of the LED depends on the number of pulses emitted (0 % to 100 %) (pulse output mode only)	
Output current		
Rated value, per channel	100 mA	
Maximum value (all channels together, configurable outputs included)	8 A	
Leakage current with signal 0	< 0.5 mA	
Rated protection fuse on UP	10 A fast	
De-magnetization when inductive loads are switched off	with varistors integrated in the module	
Overload message ($I > 0.1 \times I_A$)	Yes, after ca. 100 ms	
Output current limitation	Yes, automatic reactivation after short-circuit/overload	
Resistance to feedback against 24 V signals	Yes	
Process voltage UP		
Nominal voltage	24 V DC	
Maximum ripple	5 %	
Current consumption on UP		
Min. (module alone)	0.070 A	
Max. (min. + loads)	0.070 A + load	
Reverse polarity protection	•	
Fuse for process voltage UP	10 A miniature fuse	

AC500

Technical data

Analog/digital mixed I/O extension modules

For all modules: max cable length for connected process signals is 1000 m for shielded cable and 600 m for unshielded ones. For all Input modules, the signal resolution for channel configuration is: -10...+10 V: 13 bits including sign; 0...10 V, 0...20 mA, 4...20 mA: 12 bits.

Type	DA501	DA502
Number of Channels per Module		
Digital	inputs	16
	outputs	–
Analog	inputs	4
	outputs	2
Digital configurable channels DC (configurable as inputs or outputs)	8	8
Additional configuration of channels as		
Fast counter	Yes	
Occupies max. 1 DO or DC when used as counter	Configuration of max. 2 channels per module. Operating modes see table on page 189	
Connection via terminal unit TU 5xx	●	
Digital inputs		
Input	signal voltage	24 V DC
	characteristic acc. to EN 61132-2	Type 1
0 signal	-3...+5 V DC	
Undefined signal state	5...15 V DC	
1 signal	15...30 V DC	
Residual ripple, range for	0 signal	-3...+5 V DC
	1 signal	15...30 V DC
Input time delay (0 -> 1 or 1 -> 0)	8 ms typically, configurable from 0.1 up to 32 ms	
Digital outputs		
Transistor outputs 24 V DC, 0.5 A	●	
Readback of output	●	
Outputs, supplied via process voltage UP	●	
Switching of 24 V load	●	
Output voltage at signal state 1	Process voltage UP - 0.8 V	
Output current		
Nominal current per channel	0.5 A	
Maximum (total current of all channels)	4 A	8 A
Residual current at signal state 0	< 0.5 mA	
Demagnetization when switching off inductive loads	By internal varistors	
Analog inputs AI		
Signal configuration per AI	●	
0...10 V / -10 ... +10 V	4 / 4	
0...20 mA / 4...20 mA	4 / 4	
RTD using 2/3 wire needs 1/2 channel(s)	4 / 2	
0...10 V using differential inputs, needs 2 channels	4 / 2	
-10...+10 V using differential inputs, needs 2 channels	4 / 2	
Digital signals (digital input)	4 / 4	
Data when using the AI as digital input		
Input	time delay	8 ms typically, configurable from 0.1 up to 32 ms
	signal voltage	24 V DC
Outputs, single configurable as		
Possible configuration per AO	●	
-10...+10 V	●	
0...20 mA / 4...20 mA	●	
Output resistance (load) when used as current output	0...500 Ω	
Output loading capability when used as voltage output	±10 mA max.	
Potential isolation		
Per module	●	
Process voltage UP		
Nominal voltage	24 V DC	
Maximum ripple	5 %	
Current consumption on UP		
Min. (module alone)	0.070 A	
Max. (min. + loads)	0.070 A + load	
Reverse polarity protection	●	
Fuse for process voltage UP	10 A fast	
Approvals	See detailed page 284 or new.abb.com/plc	

AC500

Technical data

DC541-CM interrupt I/O and fast counter module

In the operating mode counter, the channels can be configured as follows:

Input, Output, 32-bit up/down counter (uses C0...C3) as a 32-bit counter without limit, 32-bit periodic counter as a 32-bit counter with a limit, limiter for a 32-bit counter (limit channel 0), 32-bit up counter (forward counter) with the frequencies 50 kHz, 5 kHz and 2.5 kHz, pulse-width modulation (PWM) with a resolution of 10 kHz, time and frequency measurement, frequency output.

Type	DC541-CM	
Number of channels per module		
Configurable channels DC (configurable as inputs or outputs)	8	
Additional configuration of channels as		
Fast counter	Yes	
Connection via CPU terminal base. Occupies one communication module slot	●	
Digital inputs		
Input	signal voltage	24 V DC
	characteristic acc. to EN 61132-2	Type 1
0 signal	-3...+5 V DC	
Undefined signal state	5...15 V DC	
1 signal	5...30 V DC	
Input time delay (0 -> 1 or 1 -> 0)	20 μs Clamp to clamp - 300 μs with interrupt task	
Input current per channel		
At input voltage	24 V DC	5 mA typically
	5 V DC	> 1 mA
	15 V DC	> 5 mA
	30 V DC	< 8 mA
Digital outputs		
Transistor outputs 24 V DC, 0.5 A	●	
Readback of output	●	
Switching of 24 V load	●	
Output voltage at signal state 1	Process voltage UP minus 0.8 V	
Output current		
Nominal current per channel	0.5 A	
Maximum (total current of all channels)	4 A	
Residual current at signal state 0	< 0.5 mA	
Demagnetization when switching off inductive loads	yes	
Potential isolation		
Per module	●	
Voltage supply for the module	Internally via backplane bus	

AC500

Technical data

DC541-CM interrupt I/O and fast counter module

Interrupt I/O table

Configuration as		Configuration for channel no.					Max. no. of channels for this function	Remarks and notes regarding possible alternative combinations of the remaining channels (a and b)
		Chan. 0	Chan. 1	Chan. 2	Chan. 3	Chan. 4-7		
Mode 1: Interrupt functionality								
Interrupt	Digital input	1	1	1	1	4	8	Each channel can be configured individually as interrupt input or output
	Digital output	1	1	1	1	4	8	
Mode 2: Counting functionality								
Digital I/Os PWM (1)	Digital input	1	1	1	1	4	8	Usual input
	Digital output	1	1	1	1	4	8	Usual output
	PWM, resolution 10 kHz	1	1	1	1	4	8	Outputs and pulsed signal with and adjustable on-off ratio

(1) Counter and fast counter data available on technical documentation. Not for use on V3 CPU.

AC500

Technical data

AC500 Condition Monitoring CMS: FM502-CMS

The FM502-CMS function module offers precision and dynamic flexibility for customized solutions in condition monitoring, precise measurement or fast data logging applications. It has 16 fast, precise and synchronized analog inputs with 50k Samples/s (SPS), 24bit ADC resolution, completed with encoder inputs (incremental or absolute) with counter and additional DI and DC inputs/outputs onboard. It is easily configured using the Automation Builder software and the special libraries. Overall it has 12 different operation modes. One FM502 function module can be placed on the right side of PM592-ETH CPU with a special function module terminal base TF5x1, to interface directly to the CPU. While long measurements can be flexibly configured, started and stopped, all inputs are available in the I/O Image of CPU for immediate use (measurement, protection, control, ...)

Type	FM502-CMS	
Data storage		
Fast user data memory of FM502	128 MB (ca. 33 million Samples: e.g 40 s record length on 16 channels at 50k SPS or 5.8 h record length on 16 channels at 100 SPS or 93 h on 1 channel at 100 SPS)	
File Format delivered to PM592 flash	WAV (compact binary) per channel, all channels in one *.zip w. time stamp	
Analog inputs		
Number of channels	16 (synchronous sampled)	
Resolution	24 bit ADC, stored in DINT in WAV file (4byte per value)	
Accuracy at +25 °C	< +/- 0.1 %	
Accuracy over operating temperature and vibration	< +/- 0.5 %	
Sample rate / Bandwidth (High, 0 dB)	50k SPS / 20 kHz to 100 SPS / 40 Hz (digitally downsampled, selectable per channel)	
Indication of the input signal	One bicolor LED per channel for configuration, measurement status, error messages	
Input option:	IEPE (with Sensor supply current)	+ - 10 V
Bandwidth low (- 3 dB)	digital < 0.1 Hz	digital < 0.1 Hz or DC (selectable)
Pass band high (- 3 dB)	analog > 90 kHz, digital > 24.5 kHz	
Stop band high (> - 100 dB)	analog > 1 MHz, digital > 27.5 kHz	
Dynamic Range (SFDR)	> 100 dB	
SINAD (300 Hz/1 kHz sine, 50 k SPS) 0dB from full scale	< -90 dB	< - 95 dB
IEPE Current Source per channel	Typ. 4.2 mA (+/- 7 % over temperature)	(n.a.)
Resistance AI- to M (ground)	Typ ~ 270Ohm (PTC)	
Channel input impedance (AI+/AI-):		
< 1kHz	> 1 MOhm	> 2 MOhm
5kHz	> 100 kOhm	> 40 kOhm
10kHz	> 60 kOhm	> 25 kOhm
20kHz	> 40 kOhm	> 8 kOhm
Error detection	Short circuit, open wire	
Max. cable length, shielded (depending on sensor)	100 m	
Digital inputs/outputs		
	24 V DC, dedicated inputs/outputs can be used for specific counting functions. All unused inputs/outputs can be used as normal input/output with standard specification.	
Channels and types	2 DI + 2 DC (configurable inputs/outputs); Type 1, LED indication	
Input options	Catch/Touch operation, counter value stored in separate variable on external event (rising or falling) Set to preset counter register with predefined value Set to reset counter register	
End value output	Output set when predefined value is reached	
Reference point initialization (RPI) input for relative encoder initialization	●	
Input current p. channel @ V DC		
24 V DC	Typically 5 mA	
5 V DC	> 1 mA	
15 V DC	> 5 mA	
30 V DC	< 8 mA	

AC500

Technical data

Type	FM502-CMS	
Digital outputs		
Output voltage at signal state 1	(L+) – 0.8 V	
Output current		
Nominal current per channel	0.5 A	
Residual current at signal state 0	< 0.5 mA	
Demagnetization when switching off inductive loads	By internal varistors	
Switching frequency		
For inductive load	Max. 0.5 Hz	
For lamp load	Max. 11 Hz with max. 5 W	
Short-circuit / Overload proofness	•	
Overload indication (I > 0.7 A)	After approx. 100 ms	
Output current limiting	•	
Resistance against reverse feeding of 24 V signals	•	
Maximum cable length for connected process signals		
shielded	1000 m	
unshielded	600 m	
High-speed counter/encoder		
Integrated counters		
Counter characteristics	2 counters (24 V DC, 5 V DC, differential RS422: 5 V or 1 Vpp sinus input)	
Counter mode	one counter 32 bits or two counters 16 bits	
Relative position encoder	X1, X2, X3	
Absolute SSI encoder	•	
Time frequency meter	•	
Frequency input	up to 300 kHz	
Additional configuration of channels as		
Fast counter	Integrated 2 counter encoders	
high-speed inputs		
Number of channels, type per module	3 (A,B,Z), type 1	
Input type	24 V DC	5 V DC / Differential / Sinus 1 Vpp
Frequency	up to 300 kHz (input filter: 50,500, 5 k, 20 k Hz)	
Input frequency max. (frequency measurement only)	100 kHz (accuracy -0 %/+3 %)	
Max. cable length, shielded (depending on sensor)	300 m	100 m
Fast outputs		
SSI CLK output B	f. optical Interface (according SSI): Pin 1.3	RS-422 differential (according SSI) Pins 1.3, 1.4
Output delay (0->1 or 1->0)	Max. 0.35 µs	
Output current	≤ 10 mA	
Switching frequency (selectable)	200 kHz, 500 kHz and 1 MHz	
Short-circuit proof / overload proof	Yes	
Output current limitation	Yes, automatic reactivation after short-circuit/overload	
Resistance to feedback against 24V signals	Yes	
Resistance to feedback against reverse polarity	Yes	
Max. cable length, shielded (depending on sensor)	100 m	
Process voltage L+		
Nominal voltage	24 V DC	
Current consumption from L+ (FM502 and PM592, no communication module)	Max. 0.43 A + max. 0.5 A per output	
Inrush current from L+ (at power up, FM502 and PM592, no communication module)	1.2 A ² s	
Electrical isolation	Yes, (PM592 and FM502 to other I/O-Bus modules)	
Max. power dissipation within the FM502 module	6.5 W (outputs unloaded)	
5-V-encoder supply output		
Nominal voltage	5 V DC (+/- 5 %), 100 mA max.	

AC500

Technical data

AC500 communication modules

- Up to 4 communications modules can be used on an AC500 CPU, up to 6 on AC500 V3 CPU.
- No external power supply required.

Type	CM592-DP	CM582-DP	CM597-ETH	CM5640-2ETH	CM598-CN	CM588-CN	CM579-PNIO
AC500 V3 support	●	●	–	● (3)	● (4)	–	●
Communication interfaces							
RJ45	–	–	● (x 2) (2)	● (x 2) no switch	–	–	● (x 2) (2)
RS-232 / 485	–	–	–	–	–	–	–
Terminal blocks (1)	–	–	–	–	●	●	–
Sub-D socket	●	●	–	–	–	–	–
Protocols	PROFIBUS DP V0/V1 master	PROFIBUS DP V0/V1 slave	Ethernet (TCP/IP, UDP/IP, Modbus TCP)	Ethernet (TCP/IP, UDP/IP, Modbus TCP)	CANopen master	CANopen slave	PROFINET IO controller
Transfer Rate	9.6 kbit/s to 12 Mbit/s	9.6 kbit/s to 12 Mbit/s	10 / 100 Mbit/s	10 / 100 Mbit/s Port extender (5)	10 kbit/s to 1 Mbit/s	10 kbit/s to 1 Mbit/s	100 Mbit/s
Co-processor							
Memory	–	–	–	–	–	–	–
Additional features	Multi master functionality Max. Number of subscribers: • 126 (V0) • 32 (V1)	–	Online access, ICMP (Ping), DHCP, IP configuration protocol, UDP data exchange, Modbus TCP	Online access, ICMP (Ping), DHCP, IP configuration protocol, UDP data exchange, Network variables, Modbus TCP, OPC UA, SNTP/NTP	CAN 2.0A CAN 2.0B CANopen	NMT Slave PDO SDO server Heartbeat Nodeguard	RTC - Real-time Cyclic Protocol, Class 1 RTA - Real-time Acyclic Protocol DCP Discovery and Configuration Protocol CL-RPC - Connectionless Remote Procedure Call

Type	CM589-PNIO	CM589-PNIO-4	CM579-ETHCAT	CM574-RS	CM5610-2RS	CM574-RCOM
AC500 V3 support	●	●	●	–	● (3)	–
Communication interfaces						
RJ45	● (x 2) (2)	● (x 2) (2)	● (x 2)	–	–	–
RS-232 / 485	–	–	–	● (x 2)	● (x 2)	● (x 2)
Terminal blocks (1)	–	–	–	● (x 2)	● (x 2)	● (x 2)
Sub-D socket	–	–	–	–	–	–
Protocols	PROFINET IO device	PROFINET IO 4 x devices	EtherCAT master	Serial COM ASCII, Modbus RTU, CS31	Serial COM ASCII, Modbus RTU	Serial RCOM/ RCOM+
Transfer Rate	100 Mbit/s	100 Mbit/s	10 / 100 Mbit/s	9.6 kbit/s up to 187.5 kbit/s	9.6 kbit/s up to 112 kbit/s Port extender	2,4 kbit/s to 19.2 kbit/s
Co-processor				Programmable CPU like PM57x with PowerPC 50 MHz processor		
Memory	–	–	–	256 kB program memory 384 kB data memory	–	–
Additional features	RTC - Real-time Cyclic Protocol, Class 1 RTA - Real-time Acyclic Protocol DCP Discovery and Configuration Protocol LLDP - Link Layer Discovery Protocol	RTC - Real-time Cyclic Protocol, Class 1 RTA - Real-time Acyclic Protocol DCP Discovery and Configuration Protocol LLDP - Link Layer Discovery Protocol	CoE (Can over EtherCAT) process data (PDO) (cyclic) CoE Mailbox data (SDO) (acyclic) Distributed Clock (32-bit, 64-bit)	• Stand alone CPU in coupler module housing allowing to be used as standard serial interface or as free programmable serial interface coupler. • Independent internal CPU programmable for own communication protocol or data processing. • 2 x CS31 master, Modbus master/slave, free configurable, protocols ASCII.	Acts as a serial interface extender from the CPU used. The CPU handles the protocol like ASCII or Modbus RTU on both interfaces	–

(1) Plug-in terminal block included.

(2) 10 / 100 Mbit/s, full/half duplex with auto-sensing, 2-port switch integrated

(3) In preparation

(4) Only with CAN 2A/2B today

(5) The CM5640-2ETH communication module is a port extender providing 2 additional "onboard Ethernet" interfaces to the connected CPU which manages all the communication. Some of the onboard Ethernet features are available, the Ethernet limitations from the CPU will then apply in total for all the connected interfaces. The CM5640-2ETH doesn't extend the limits which remain those of the connected CPU, e.g. no increase of Ethernet sockets or number of OPC UA tags.

AC500

Technical data

Communication interface modules

For all modules: max cable length for connected process signals is 1000 m for shielded cable and 600 m for unshielded ones. For all Input modules, the signal resolution for channel configuration is: -10...+10 V: 13 bits including sign; 0...10 V, 0...20 mA, 4...20 mA: 12 bits. Temperature: 0.1 °C.

Type	DC551-CS31	CI5 90-CS31-HA (1)	CI592-CS31	
Communication Interface				
Protocol	Proprietary CS31 bus protocol on RS485 interface			
ID configuration	Per rotary switches on front face from 00d to 99d			
Field bus connection on terminal units	CS31 field bus, via terminal / redundant for CI590-CS31-HA on TU551-CS31 or TU552-CS31			
Number of Channels per Module				
Digital	inputs	8	–	8
	outputs	–	–	–
Analog	inputs	–	–	4
	outputs	–	–	2
Digital configurable channels DC (configurable as inputs or outputs)		16	16	8
Additional configuration of channels as				
Fast counter	Configuration of max. 2 channels per module			
Occupies max. 1 DO or DC when used as counter	●	●	●	
Connection				
Via terminal unit TU5xx	●	●	●	
Local I/O extension				
Max. number of extension modules	max. 7 x S500 extension modules (standard or eCo), up to 31 stations with up to 120 DIs/120 DOs or up to 32 AIs/32AOs per station			
		not for S500-eCo I/O modules		
Digital inputs				
Input	signal voltage	24 V DC		
	characteristic acc. to EN 61132-2	Type 1		
0 signal		-3...+5 V DC		
Undefined signal state		5...15 V DC		
1 signal		15...30 V DC		
Residual ripple, range for	0 signal	-3...+5 V DC		
	1 signal	15...30 V DC		
Input time delay (0 -> 1 or 1 -> 0)	8 ms typically, configurable from 0.1 up to 32 ms			
Digital outputs				
Transistor outputs 24 V DC, 0.5 A	●			
Readback of output	●			
Outputs, supplied via process voltage UP	●			
Switching of 24 V load	●			
Output voltage at signal state 1	Process voltage UP - 0.8 V			
Output current				
Nominal current per channel	0.5 A			
Maximum (total current of all channels)	8 A	8 A	4 A	
Residual current at signal state 0	< 0.5 mA			
Demagnetization when switching off inductive loads	By internal varistors			
Analog inputs AI				
Max. number per module and with regard to the configuration: AIs / Measuring points				
Signal configuration per AI	–		●	
0...10 V / -10...+10 V	–		4 / 4	
0...20 mA / 4...20 mA	–		4 / 4	
RTD using 2/3 wire needs 1/2 channel(s)	–		4 / 2	
0...10 V using differential inputs, needs 2 channels	–		4 / 2	
-10...+10 V using differential inputs, needs 2 channels	–		4 / 2	
Digital signals (digital input)	–		4 / 4	

(1) Dedicated to High Availability.

AC500

Technical data

Communication interface modules

Type		DC551-CS31	CI590-CS31-HA (1)	CI592-CS31
Data when using the AI as digital input				
Input	time delay	-		8 ms typically, configurable from 0.1 up to 32 ms
	signal voltage	-		24 V DC
Outputs, single configurable as				
Possible configuration per AO		-		•
-10...+10 V		-		•
0...20 mA / 4...20 mA		-		•
Output	resistance (load) when used as current output	-		0...500 Ω
	loading capability when used as voltage output	-		±10 mA max.
Potential isolation				
Per module		•	•	•
Between fieldbus interface against the rest of the module		•	•	•
Voltage supply for the module		By external 24 V DC voltage via terminal UP		
Process voltage UP				
Nominal voltage		24 V DC		
Current consumption on UP				
Min. (module alone)		0.100 A	0.100 A	0.070 A
Max. (min. + loads)		0.100 A + load	0.100 A + load	0.070 A + load
Reverse polarity protection		•		
Fuse for process voltage UP		10 A miniature fuse		
Approvals		See detailed page 284 or new.abb.com/plc		

(1) Dedicated to High Availability.

AC500

Technical data

PROFIBUS-DP modules

Type	CI541-DP	CI542-DP
Communication Interface		
Protocol	PROFIBUS DP (DP-V0 and DP-V1 slave)	
ID configuration	Per rotary switches on front face from 00h to FFh	
Field bus connection on terminal units	Sub-D 9 poles on TU509, TU510 preferred but TU517/TU518 can be used with baud rate up to 1Mbaud	
Number of Channels per Module		
Digital	inputs	8
	outputs	8
Analog	inputs	–
	outputs	–
Digital configurable channels DC (configurable as inputs or outputs)	–	8
Additional configuration of channels as		
Fast counter (onboard I/O)	Configuration of max. 2 DI channels per module	
Occupies max 1 DO or DC when used as counter	●	
Connection		
Local I/O extension	●	
Max. number of extension modules	max. 10 x S500 extension modules (standard or eCo modules allowed). Fast counter from digital I/O modules can be also used.	
Via terminal unit TU5xx	●	
Digital inputs		
Input	signal voltage	24 V DC
	characteristic acc. to EN 61132-2	Type 1
0 signal		-3...+5 V DC
Undefined signal state		5...15 V DC
1 signal		15...30 V DC
Residual ripple, range for	0 signal	-3...+5 V DC
	1 signal	15...30 V DC
Input time delay (0 -> 1 or 1 -> 0)	8 ms typically, configurable from 0.1 up to 32 ms	
Digital outputs		
Transistor outputs 24 V DC, 0.5 A	●	
Readback of output	–	● (on DC outputs)
Outputs, supplied via process voltage UP	●	
Switching of 24 V load	●	
Output voltage at signal state 1	Process voltage UP - 0.8 V	
Output current		
Nominal current per channel	0.5 A	
Maximum (total current of all channels)	8 A	
Residual current at signal state 0	< 0.5 mA	
Demagnetization when switching off inductive loads	By internal varistors	
Analog Inputs AI		
	Max. number per module and with regard to the configuration: AIs / Measuring points	
Signal configuration per AI	4	–
0...10 V / -10...+10 V	4 / 4	–
0...20 mA / 4...20 mA	4 / 4	–
RTD using 2/3 wire needs 1/2 channel(s)	4 / 2	–
0...10 V using differential inputs, needs 2 channels	4 / 2	–
-10...+10 V using differential inputs, needs 2 channels	4 / 2	–
Digital signals (digital input)	4 / 4	–
Data when using the AI as digital input		
Input	Input time delay	8 ms typically, configurable from 0.1 up to 32 ms
	signal voltage	24 V DC

AC500

Technical data

PROFIBUS-DP modules

Type	CI541-DP	CI542-DP
Outputs, single configurable as		
Possible configuration per AO	●	-
-10...+10V	●	-
0...20 mA / 4...20 mA	●	-
Output resistance (load) when used as current output	0...500 Ω	-
loading capability when used as voltage output	±10 mA max.	-
Potential isolation		
Per module	●	●
Between fieldbus interface against the rest of the module	●	●
Between the channels		
input	-	-
output	-	-
Voltage supply for the module	By external 24 V DC voltage via terminal UP	
Process voltage UP		
Nominal voltage	24 V DC	
Current consumption on UP		
Min. (module alone)	0.260 A	
Max. (min. + loads)	0.260 A + load	
Reverse polarity protection	●	
Fuse for process voltage UP	10 A miniature fuse	
Approvals	See detailed page 284 or new.abb.com/plc	

AC500

Technical data

CANopen modules

Type	CI581-CN	CI582-CN	
Communication interface			
Protocol	CANopen slave, DS401 profile selectable using rotary switches		
ID configuration	Per rotary switches on front face for CANopen ID node from 00h to 7Fh and 80h to FFh for CANopen DS401 profile		
Field bus connection on terminal units	Terminal blocks on TU517/TU518 or TU509/TU510		
Number of channels per module			
Digital	inputs	8	
	outputs	8	
Analog	inputs	–	
	outputs	–	
Digital configurable channels DC (configurable as inputs or outputs)	–	8	
Additional configuration of channels as			
Fast counter (onboard I/O)	Configuration of max. 2 DI channels per module		
Occupies max. 1 DO or DC when used as counter	●	●	
Connection			
Local I/O extension	●		
Max. number of extension modules	max. 10 x S500 extension modules (standard or eCo modules are allowed)		
Via terminal unit TU5xx	●	●	
Digital inputs			
Input	signal voltage	24 V DC	
	characteristic acc. to EN 61132-2	Type 1	
0 signal		-3...+5 V DC	
Undefined signal state		5...15 V DC	
1 signal		15...30 V DC	
Residual ripple, range for	0 signal	-3...+5 V DC	
	1 signal	15...30 V DC	
Input time delay (0 -> 1 or 1 -> 0)	8 ms typically, configurable from 0.1 up to 32 ms		
Digital outputs			
Transistor outputs 24 V DC, 0.5 A	●		
Readback of output	–	● (on DC outputs)	
Outputs, supplied via process voltage UP	●		
Switching of 24 V load	●		
Output voltage at signal state 1	Process voltage UP - 0.8 V		
Output current			
Nominal current per channel	0.5 A		
Maximum (total current of all channels)	8 A		
Residual current at signal state 0	< 0.5 mA		
Demagnetization when switching off inductive loads	By internal varistors		
Analog Inputs AI	Max. number per module and with regard to the configuration: AIs / Measuring points		
Signal configuration per AI	4	–	
0...10 V / -10...+10 V	4 / 4	–	
0...20 mA / 4...20 mA	4 / 4	–	
RTD using 2/3 wire needs 1/2 channel(s)	4 / 2	–	
0...10 V using differential inputs, needs 2 channels	4 / 2	–	
-10...+10 V using differential inputs, needs 2 channels	4 / 2	–	
Digital signals (digital input)	4 / 4	–	
Data when using the AI as digital input			
Input	time delay	8 ms typically, configurable from 0.1 up to 32 ms	–
	signal voltage	24 V DC	–

AC500

Technical data

CANopen modules

Type	CI581-CN	CI582-CN
Outputs, single configurable as		
Possible configuration per AO	●	-
-10...+10 V	●	-
0...20 mA / 4...20 mA	●	-
Output		
resistance (load) when used as current output	0...500 Ω	-
loading capability when used as voltage output	±10 mA max.	-
Potential isolation		
Per module	●	●
Between fieldbus interface against the rest of the module	●	●
Between the channels		
input	-	-
output	-	-
Voltage supply for the module	By external 24 V DC voltage via terminal UP	
Process voltage UP		
Nominal voltage	24 V DC	
Current consumption on UP		
Min. (module alone)	0.260 A	
Max. (min. + loads)	0.260 A + load	
Reverse polarity protection	●	
Fuse for process voltage UP	10 A miniature fuse	
Approvals	See detailed page 284 or new.abb.com/plc	

AC500

Technical data

PROFINET IO RT device modules

Type	CI501-PNIO	CI502-PNIO	CI504-PNIO	CI506-PNIO
Communication interface				
Ethernet Interface				
Main protocol	PROFINET IO RT device			
ID Device configuration	By rotary switch on the front side, from 00h to FFh			
Ethernet connection on terminal units	2 x RJ45 with switch functionality for simple daisy chain on TU507-ETH or TU508-ETH or TU520-ETH			
Gateway Interface				
Gateway to	-	-	3 x RS232 / RS422 / RS485 ASCII serial interfaces	CAN / CANopen Master + 2 x RS232 / RS422 / RS485 ASCII serial interfaces
Fieldbus Protocol used	-	-	-	CAN 2A/2B Master - CANopen Master (1)
CAN physical interface	-	-	-	1 x 10 poles pluggable spring connector
Baudrate	-	-	-	Baudrate up to 1 Mbit/s, Support for up to 126 CANopen Slaves
Serial interface				
Protocol used	-	-	3 x RS232 / RS422 or RS485	2 x RS232 / RS422 or RS485
Baudrate	-	-	Configurable from 300 bit/s to 115200 bit/s	
Fieldbus or serial connection on terminal units	-	-	3 x pluggable terminal blocks with spring on TU520-ETH	
Number of channels per module				
Digital	inputs	8	8	-
	outputs	8	8	-
Analog	inputs	4	-	-
	outputs	2	-	-
Digital configurable channels DC (configurable as inputs or outputs)		-	8	-
Additional configuration of channels as				
Fast counter (onboard I/O)		Configuration of max. 2 DI channels per module		
Occupies max. 1 DO or DC when used as counter		●	-	-
Connection				
Local I/O extension		●	●	●
Max. number of extension modules		max. 10 x S500 extension modules (standard or eCo modules allowed). Fast counter from digital I/O modules can be also used.		
Via terminal unit TU5xx		●	●	●
Digital inputs				
Input	signal voltage	24 V DC		
	characteristic acc. to EN 61132-2	Type 1		
0 signal		-3...+5 V DC		
Undefined signal state		5...15 V DC		
1 signal		15...30 V DC		
Residual ripple, range for	0 signal	-3...+5 V DC		
	1 signal	15...30 V DC		
Input time delay (0 -> 1 or 1 -> 0)		8 ms typically, configurable from 0.1 up to 32 ms		
Digital outputs				
Transistor outputs 24 V DC, 0.5 A		●	-	-
Readback of output		-	● (on DC outputs)	-
Outputs, supplied via process voltage UP		●	-	-
Switching of 24 V load		●	-	-
Output voltage at signal state 1		Process voltage UP - 0.8 V		

(1) Not simultaneously.

AC500

Technical data

PROFINET IO RT device modules

Type	CI501-PNIO	CI502-PNIO	CI504-PNIO	CI506-PNIO
Output current				
Nominal current per channel	500 mA at UP = 24 V DC		-	-
Maximum (total current of all channels)	8 A		-	-
Residual current at signal state 0	< 0.5 mA		-	-
Demagnetization when switching off inductive loads	By internal varistors		-	-
Analog inputs AI				
	Max. number per module and with regard to the configuration: AIs / Measuring points			
Signal configuration per AI	4	-	-	-
0...10 V / -10... +10 V	4 / 4	-	-	-
0...20 mA / 4...20 mA	4 / 4	-	-	-
RTD using 2/3 wire needs 1/2 channel(s)	4 / 2	-	-	-
0...10 V using differential inputs, needs 2 channels	4 / 2	-	-	-
-10...+10 V using differential inputs, needs 2 channels	4 / 2	-	-	-
Digital signals (digital input)	4 / 4	-	-	-
Data when using the AI as digital input				
Input	time delay	8 ms typically, configurable from 0.1 up to 32 ms	-	-
	signal voltage	24 V DC	-	-
Outputs, single configurable as				
Possible configuration per AO	●	-	-	-
-10...+10 V	●	-	-	-
0...20 mA / 4...20 mA	●	-	-	-
Output	resistance (load) when used as current output	0...500 Ω	-	-
	loading capability when used as voltage output	±10 mA max.	-	-
Potential isolation				
Per module	●	●	●	●
Between Ethernet interface against the rest of the module	●	●	●	●
Voltage supply for the module	By external 24 V DC voltage via terminal UP			
Process voltage UP				
Nominal voltage	24 V DC			
Current consumption on UP				
	min. (module alone)	0.260 A	0.150 A	
	max. (min. + loads)	0.260 A + load	0.150 A	
Reverse polarity protection	●			
Fuse for process voltage UP	10 A miniature fuse			
Approvals	See detailed page 284 or new.abb.com/plc			

(1) Not simultaneously.

AC500

Technical data

EtherCAT modules

Type	CI511-ETHCAT	CI512-ETHCAT	
Communication interface			
Protocol	EtherCAT slave with CAM-Switch configurable function on the digital outputs		
ID Device configuration	Address is defined by position on Ethernet bus		
Field bus connection on TUs	2 x RJ45 with switch functionality for simple daisy chain on TU507-ETH or TU508-ETH		
Number of channels per module			
Digital	inputs	8	8
	outputs	8	8
Analog	inputs	4	–
	outputs	2	–
Digital configurable channels DC (configurable as inputs or outputs)	–	–	8
Additional configuration of channels as			
Fast counter (onboard I/O)	–	–	
Occupies max. 1 DO or DC when used as counter	–	–	
Connection			
Local I/O extension	●		
Max. number of extension modules	max. 10 x S500 extension modules (standard or eCo modules allowed). Fast counter from digital I/O modules can be also used.		
Via terminal unit TU5xx	●		
Digital inputs			
Input signal voltage	24 V DC		
Input characteristic acc. to EN 61 132-2	Type 1		
0 signal	-3...+5 V DC		
Undefined signal state	5...15 V DC		
1 signal	15...30 V DC		
Residual ripple, range for	0 signal	-3...+5 V DC	
	1 signal	15...30 V DC	
Input time delay (0 -> 1 or 1 -> 0)	8 ms typically, configurable from 0.1 up to 32 ms		
Digital outputs			
Transistor outputs 24 V DC, 0.5 A	●		
Readback of output	–	● (on DC outputs)	
Outputs, supplied via process voltage UP	●		
Switching of 24 V load	●		
Output voltage at signal state 1	Process voltage UP - 0.8 V		
Output current			
Nominal current per channel	500 mA at UP = 24 V DC		
Maximum (total current of all channels)	8 A		
Residual current at signal state 0	< 0.5 mA		
Demagnetization when switching off inductive loads	By internal varistors		
Analog inputs AI			
Max. number per module and with regard to the configuration: AIs / Measuring points			
Signal configuration per AI	4	–	
0...10 V / -10 V... +10 V	4 / 4	–	
0...20 mA / 4...20 mA	4 / 4	–	
RTD using 2/3 wire needs 1/2 channel(s)	4 / 2	–	
0...10 V using differential inputs, needs 2 channels	4 / 2	–	
-10...+10 V using differential inputs, needs 2 channels	4 / 2	–	
Digital signals (digital input)	4 / 4	–	
Data when using the AI as digital input			
Input	time delay	8 ms typically, configurable from 0.1 up to 32 ms	–
	signal voltage	24 V DC	–

AC500

Technical data

EtherCAT modules

Type	CI511-ETHCAT	CI512-ETHCAT
Outputs, single configurable as:		
Possible configuration per AO	●	-
-10...+10 V	●	-
0...20 mA / 4...20 mA	●	-
Output resistance (load) when used as current output	0...500 Ω	-
Output loading capability when used as voltage output	±10 mA max.	-
Potential isolation		
Per module	●	●
Between Ethernet interface against the rest of the module	●	●
Between the channels		
input	-	-
output	-	-
Voltage supply for the module	By external 24 V DC voltage via terminal UP	
Process voltage UP		
Nominal voltage	24 V DC	
Current consumption on UP		
min. (module alone)	0.260 A	
max. (min. + loads)	0.260 A + load	
Reverse polarity protection	●	
Fuse for process voltage UP	10 A miniature fuse	
Approvals	See detailed page 284 or new.abb.com/plc	

AC500

Technical data

Modbus TCP modules

Type	CI521-MODTCP	CI522-MODTCP	
Communication interface			
Ethernet Interface			
Main protocol	Modbus TCP		
ID Device configuration	By rotary switch on the front side, from 00h to FFh		
Ethernet connection on terminal units	2 x RJ45 with switch functionality for simple daisy chain on TU507-ETH or TU508-ETH		
Number of channels per module			
Digital	inputs	8	8
	outputs	8	8
Analog	inputs	4	–
	outputs	2	–
Digital configurable channels DC (configurable as inputs or outputs)		–	8
Additional configuration of channels as			
Fast counter (onboard I/O)	Configuration of max. 2 DI channels per module		
Occupies max. 1 DO or DC when used as counter	●		
Connection			
Local I/O extension	●		
Max. number of extension modules	max. 10 x S500 extension modules (standard or eCo modules allowed). Fast counter from digital I/O modules can be also used.		
Via terminal unit TU5xx	●	●	
Digital inputs			
Input	signal voltage	24 V DC	
	characteristic acc. to EN 61132-2	Type 1	
0 signal		-3...+5 V DC	
Undefined signal state		5...15 V DC	
1 signal		15...30 V DC	
Residual ripple, range for	0 signal	-3...+5 V DC	
	1 signal	15...30 V DC	
Input time delay (0 -> 1 or 1 -> 0)		8 ms typically, configurable from 0.1 up to 32 ms	
Digital outputs			
Transistor outputs 24 V DC, 0.5 A		●	
Readback of output		–	● (on DC outputs)
Outputs, supplied via process voltage UP		●	
Switching of 24 V load		●	
Output voltage at signal state 1		Process voltage UP - 0.8 V	
Output current			
Nominal current per channel		500 mA at UP = 24 V DC	
Maximum (total current of all channels)		8 A	
Residual current at signal state 0		< 0.5 mA	
Demagnetization when switching off inductive loads		By internal varistors	
Analog inputs AI		Max. number per module and with regard to the configuration: AIs / Measuring points	
Signal configuration per AI		4	–
0...10 V / -10... +10 V		4 / 4	–
0...20 mA / 4...20 mA		4 / 4	–
RTD using 2/3 wire needs 1/2 channel(s)		4 / 2	–
0...10 V using differential inputs, needs 2 channels		4 / 2	–
-10...+10 V using differential inputs, needs 2 channels		4 / 2	–
Digital signals (digital input)		4 / 4	–

(1) Not simultaneously.

AC500

Technical data

Modbus TCP modules

Type		CI521-MODTCP	CI522-MODTCP
Data when using the AI as digital input			
Input	time delay	8 ms typically, configurable from 0.1 up to 32 ms	–
	signal voltage	24 V DC	–
Outputs, single configurable as			
Possible configuration per AO		•	–
-10...+10 V		•	–
0...20 mA / 4...20 mA		•	–
Output	resistance (load) when used as current output	0...500 Ω	–
	loading capability when used as voltage output	±10 mA max.	–
Potential isolation			
Per module		•	•
Between Ethernet interface against the rest of the module		•	•
Voltage supply for the module		By external 24 V DC voltage via terminal UP	
Process voltage UP			
Nominal voltage		24 V DC	
Current consumption on UP			
min. (module alone)		0.260 A	
max. (min. + loads)		0.260 A + load	
Reverse polarity protection		•	
Fuse for process voltage UP		10 A miniature fuse	
Approvals		See detailed page 284 or new.abb.com/plc	

(1) Not simultaneously.

AC500

Technical data

CS31 functionality

	AC500 CPU with integrated CS31 interface	S500 I/O with communication interface DC551-CS31 CI590-CS31-HA CI592-CS31
Master	Yes, at COM1	–
Slave	No	Yes / Redundant for CI590-CS31-HA
Protocols supported	ABB CS31 protocol	
Diagnosis		
Error indication	On LCD display of the CPU / AC500-eCo error LED	Via module LEDs
Online diagnosis	Yes	
Error code	Errors are recorded in the diagnosis system of the CPU	
Associated function blocks	Yes	
Physical layer		
Connection	Plug at COM1	Screw-type or spring-type terminals
Baud rate	187.5 kbit/s	
Distance	AC500-eCo: up to 50 m and up to 500 m using the isolator TK506 / AC500: up to 500 m; up to 2000 m using a repeater	
Max. number of modules on fieldbus	31 modules max. Please note: The CS31 bus interface occupies one or two module addresses (if counters are configured onboard or if the module is a mixed digital analog module). Depending on the configuration, or if the module contains also mixed digital analog I/O, connected extension modules can occupy further module addresses.	
Configuration		
Station address configuration	No	Using rotary switches (99 max.)

Digital and mixed signal I/O modules, “Fast Counter” operating modes. Not applicable for DC541 or eCo-I/O modules (1)

Operating mode, configured in the user program of the AC500	Occupied inputs DI or DC	Occupied outputs DO or DC	Maximum counting frequency kHz
0 No counter	0	0	–
1 One count-up counter with “end value reached” indication	1	1	50
2 One count-up counter with “enable” input and “end value reached” indication	2	1	50
3 Two up/down counters	2	0	50
4 Two up/down counters with 1 counting input inverted	2	0	50
5 One up/down counter with “dynamic set” input	2	0	50
6 One up/down counter with “dynamic set” input	2	0	50
7 One up/down counter with directional discriminator For synchro transmitters using two counting pulses with an offset of 90° (track A and B)	2	0	50
8 –	0	0	–
9 One up/down counter with directional discriminator and double evaluation For synchro transmitters using two counting pulses with an offset of 90° towards each other (track A and B)	2	0	30
10 One up/down counter with directional discriminator and fourfold evaluation For synchro transmitters using two counting pulses with an offset of 90° towards each other (track A and B)	2	0	15

(1) See technical documentation for details.

AC500

System data

Environmental Conditions

Process and supply voltages

24 V DC	Voltage	24 V (-15 %, +20 %)
	Protection against reverse polarity	yes

Allowed interruptions of power supply	DC supply	Interruption < 10 ms, time between 2 interruptions > 1 s, PS2
---------------------------------------	-----------	---

Important: Exceeding the maximum process and supply voltages could lead to unrecoverable damage of the system. The system could be destroyed. For the supply of the modules, power supply units according to PELV or SELV specifications must be used. The creepage distances and clearances meet the requirements of the overvoltage category II, pollution degree 2.

Assembly position

Horizontal	•
Vertical	•

Temperature

Operating	0 °C ... +60 °C	Preferred mounting position horizontal. Other mounting positions see manual.
Storage / Transport	-40 °C ... +70 °C	

Humidity

Operating / Storage	Max 95 % r. H. without condensation
---------------------	-------------------------------------

Air pressure

Operating	-1000 m ... 2000 m (1080 hPa ... 800 hPa)
Storage	<3500 m (>660 hPa)

Electromagnetic Compatibility

Radiated emission (radio disturbances)	Yes, Yes, in accordance with CISPR 16-2-3
Conducted emission (radio disturbances)	Yes, Yes, in accordance with CISPR 16-2-1, CISPR 16-1-2
Electrostatic discharge (ESD)	Yes, in accordance with IEC 61000-4-2, zone B, criterion B
	Electrostatic voltage in case of air discharge: 8 kV Electrostatic voltage in case of contact discharge: 6 kV
Fast transient interference voltages (burst)	Yes, in accordance with IEC 61000-4-4, zone B, criterion B
	Supply voltage units (DC): 2 kV
	Supply voltage units (AC): 2 kV
	Digital inputs/outputs (24 V DC): 1 kV
	Digital inputs/outputs (120...240 V AC): 2 kV
	Analog inputs/outputs: 1 kV Communication lines shielded: 1 kV I/O supply (DC-out): 2 kV
High energy transient interference voltages (surge)	Yes, in accordance with IEC 61000-4-5, zone B, criterion B
	Supply voltage units (DC): 1 kV CM* / 0.5 kV DM*
	Supply voltage units (AC): 2 kV CM* / 1 kV DM*
	Digital inputs/outputs (24 V DC): 1 kV CM* / 0.5 kV DM*
	Digital inputs/outputs (120...240 V AC): 2 kV CM* / 1 kV DM*
	Analog inputs/outputs: 1 kV CM* / 0.5 kV DM* Communication lines shielded: 1 kV CM* I/O supply (DC-out): 0,5 kV CM* / 0.5 kV DM*
Influence of radiated disturbances	Yes, in accordance with IEC 61000-4-3, zone B, criterion A
	Test field strength: 10 V/m
Influence of line-conducted interferences	Yes, in accordance with IEC 61000-4-6, zone B, criterion A
	Test voltage: 10 V
Influence of power frequency magnetic fields	Yes, in accordance with IEC 61000-4-8, zone B, criterion A
	30 A/m 50 Hz 30 A/m 60 Hz

WARNING!

Risk of malfunctions and damages to persons!

Unused slots for communication modules are not protected against contact discharge. Dust and Dirt may cause contact problems and malfunctions.

Unused slots for Communication Modules must be covered with Dummy Communication Modules ("TA524 - Dummy Communication Module").

I/O-Bus connectors must not be touched during operation.

In order to prevent malfunctions, it is recommended that the operating personnel discharge themselves prior to touching communication connectors or perform other suitable measures to reduce effects of electrostatic discharges.

AC500

System data

Environmental Conditions

Environmental Tests

Storage	IEC 60068-2-1 Test Ab: cold withstand test -40 °C / 16 h IEC 60068-2-2 Test Bb: dry heat withstand test +70 °C / 16 h
Humidity	IEC 60068-2-30 Test Db: Cyclic (12 h / 12 h) Damp-Heat Test 55 °C, 93 % r. H. / 25 °C, 95 % r. H., 2 cycles
Vibration resistance	IEC 61131-2 / IEC 60068-2-6: 15 Hz ... 150 Hz, 1 g (with Memory Card inserted)
Shock resistance	IEC 60068-2-27: all 3 axes 15 g, 11 ms, half-sinusoidal

Mechanical Data

Wiring method	Spring terminals / Screw terminals	
Degree of protection	IP 20	
Assembly on DIN rail	DIN rail type	According to IEC 60715 35 mm, depth 7.5 mm or 15 mm
Assembly with screws	Screw diameter	4 mm
	Fastening torque	1.2 Nm

Main dimensions mm, inches

Type	Nr communication modules	Length L	
		mm	inches
TB511-ETH	1	95.5	3.76
TB521-ETH / TB523-2ETH	2	123.5	4.86
TB541-ETH	4	179.5	7.07
TB5600-2ETH	0	67.5	2.66
TB5610-2ETH	1	95.5	3.76
TB5620-2ETH	2	123.5	4.86
TB5640-2ETH	4	179.5	7.07
TB5660-2ETH	6	235.5	10.5

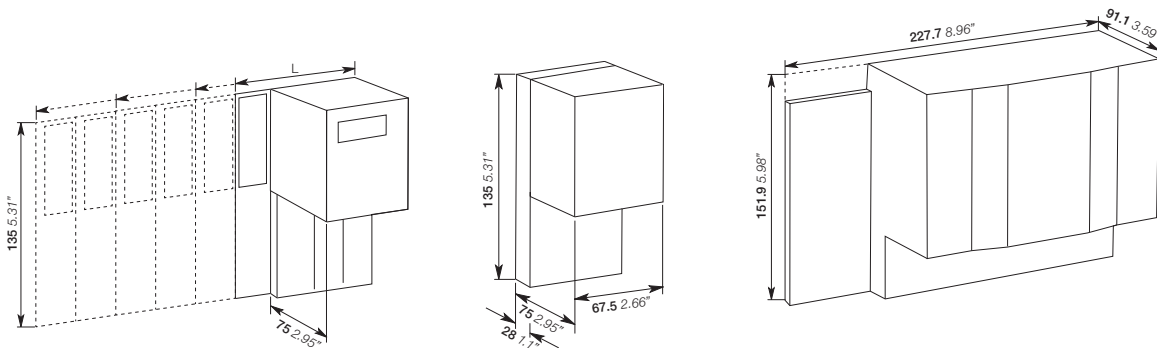

AC500-XC

PLC operating in eXtreme Conditions

195	Key features
196–208	Ordering data
209–236	Technical data
237–238	System data

79

ABB

PM592

SYS
BATT
I/O-Bus

ETH
FBP
COM1
COM2

run

PWR



RUN



ERR



WARNING
Use of
incorrect
battery may
cause fire or
explosion.

RUN

DIAG

VAL

CFG

ESC



OK



MC
502

← INSERT
→ PUSH

UP 24VDC 10W

CPU

AC500-XC

Key features



—

• Lower lifetime cost and many of the traditional practices are not required, such as: HVAC for the panel, shock absorbers, door sealing, etc...

—

• Resistance to:

- High humidity
- Salt mist
- Vibration
- High altitude
- Corrosive gases
- Temperature: from -40 to +70 °C

—

• All the benefits from AC500 range: ABB Ability™ Automation Builder engineering suite, I/O modules, scalable and flexible, same high performance communication, libraries and web services

AC500-XC

Ordering data

AC500 CPUs

- 2 internal serial interfaces, RS232 / RS485 configurable
- Display and 8 function keys for diagnosis and status
- Can be centrally extended with up to 10 I/O modules (S500) for a total of 320 Digital I/Os or 160 Analog I/Os
- Simultaneous operation of up to 4 external communication modules in any desired combination
- Optional memory card for data storage and program backup
- Can also be used as slave for PROFIBUS DP, CANopen or PROFINET IO using CM582-DP-XC, CM588-CN-XC, CM589-PNIO-XC or CM589-PNIO-4-XC communication modules
- Ethernet version provides web server and IEC 60870-5-104 remote control protocol
- Support of AC500-S safety PLC.

Program memory kB	Cycle time in μ s per instruction min. Bit/Word/Float. point	Integrated communication	Type	Order code	Weight (1 pce) kg
512	0.06 / 0.09 / 0.7	Ethernet (1), 2 x serial	PM573-ETH-XC	1SAP330300R0271	0.136
512	0.05 / 0.06 / 0.5	2 x serial	PM582-XC	1SAP340200R0201	0.137
1024	0.05 / 0.06 / 0.5	Ethernet (1), 2 x serial	PM583-ETH-XC	1SAP340300R0271	0.136
4096	0.002 / 0.004 / 0.004	Ethernet (1), 2 x serial	PM591-ETH-XC	1SAP350100R0271	0.139
4096	0.002 / 0.004 / 0.004	Ethernet (1), 2 x serial	PM592-ETH-XC (2)	1SAP350200R0271	0.155



PM573-ETH-XC



PM592-ETH-XC

AC500 CPU PM595

- 2 Ethernet interfaces with integrated switch and software configurable protocol (PROFINET IO Controller, EtherCAT Master or Ethernet e.g. Modbus TCP client/server)
- 2 independent Ethernet interfaces for programming, online access, web server, Modbus TCP, IEC 60870-5-104 protocol e.g.
- 2 serial interfaces, RS232 / RS485 configurable
- Can be centrally extended with up to 10 I/O modules (S500 and/or S500-eCo modules allowed)
- Simultaneous operation of up to 2 external communication modules in any desired combination, no need of additional terminal base

Program memory MB	Cycle time in μ s per instruction min. Bit/Word/Float. point	Integrated communication	Type	Order code	Weight (1 pce) kg
16	0.0006/0.001/0.001	2 x Ethernet for fieldbus (2 Ports switch), 2 x Ethernet (1), 2 x serial	PM595-4ETH-M-XC (2)	1SAP351500R0279	1.064

(1) Provides integrated web server and IEC 60870-5-104 remote control protocol on each interface independently.

(2) Provides integrated 4 GB flash disk for user data storage and data logging.



PM595-4ETH-M-XC

AC500-XC

Ordering data

Terminal base

- For mounting and connection of the CPUs and communication modules, not needed for PM595
- 1 to 4 plug-in communication modules
- Connection for communication coupler integrated in the CPU
- I/O interface for direct connection of up to 10 extension modules
- Connection COM1: 9-pole pluggable terminal block
- Connection COM2: D-Sub 9 (socket).

Number of coupler slots	Connection for coupler integrated in the CPU	Type	Order code	Weight (1 pce) kg
1	Ethernet RJ45	TB511-ETH-XC	1SAP311100R0270	0.164
2	Ethernet RJ45	TB521-ETH-XC	1SAP312100R0270	0.189
4	Ethernet RJ45	TB541-ETH-XC	1SAP314100R0270	0.255



TB511-ETH-XC



TB541-ETH-XC

AC500-XC

Ordering data

AC500 Condition Monitoring CMS-XC

- PLC integrated condition monitoring and fast protection for high frequency signals (vibration, current, voltage, speed/encoder)
- FM502-CMS module needs function module terminal base TF5x1 for direct interfacing to CPU, communication couplers, other I/O
 - for stand-alone or control/safety integrated condition monitoring
- PM592 CPU to be used on same TF5x1 for data storage and signal processing or communication
 - C-code interface for own complex diagnosis algorithms, 4GB Flash disk for raw fingerprints and indicator trending
- FM502-CMS module:
 - 16 fast, precise analog inputs, all synchronously sampled; configurable as IEPE or +-10V
 - individual measurement configuration (start, stop, trigger) per channel
 - per channel up to 50ksamples/s and 24bit ADC resolution, adjustable sampling
 - encoder inputs (5V or 24V) up to 300kHz counter; 12 modes, incl. absolute SSI (1MHz)
 - fast data logging, compact WAV-Files delivered automatically to CPU, incl. synchronized encoder signal if configured
 - analogue values always available for fast protection in I/O image of CPU
- Included in ABB Ability™ Automation Builder: Configuration, libraries for CMS control and wav file handling, examples
- Available download package: Signal processing library, example programs with simple diagnosis, logging and automated triggering (2)

Number of coupler slots	Description	Type	Order code	Weight (1 pce) kg
n.a.	Function Module for Condition Monitoring Systems, 16AI, 2DI, 2DC, 1x Encoder (A, B, Z)	FM502-CMS-XC	1SAP460400R0001	0.215
0	Function module terminal base for FM502, no coupler slots, 1x ETHERNET, 1x serial, spring terminals, 24 V DC	TF501-CMS-XC (1)	1SAP317000R0271	0.350
2	Function module terminal base for FM502, 2x coupler slots, 1x ETHERNET, 1x serial, spring terminals, 24 V DC	TF521-CMS-XC (1)	1SAP317200R0271	0.400

(1) Can only be used together with FM502 and PM592-ETH

(2) Download of Package under "Application Examples" at new.abb.com/plc



FM502-CMS-XC



TF501-CMS-XC



TF521-CMS-XC

AC500-XC

Ordering data

AC500-XC V3 CPUs

- 1x internal serial interface, RS232 / RS485 configurable (ACSII or Modbus RTU Master/Slave)
- 2x independent Ethernet interfaces which can also be used as switch and software configurable protocols like Modbus TCP, MQTT, Ethernet/IP Adapter or Scanner (2), KNX (2) and BACnet B-C (2), IEC 60870-5-104 or IEC 61850 (2)
- Web server with Web Visu HTML5 for use with CP600 with Web interface
- 1x internal CAN interface, with CANopen Master, CAN 2A/2B and J1939 protocols
- Display and 8 function keys for diagnosis and status
- Can be centrally extended with up to 10 I/O modules, 320 I/Os (S500 and/or S500-eCo modules allowed)
- Simultaneous operation of several external communication modules in any desired combination
- To be used exclusively with new TB56xx-2ETH
- Optional memory card for data storage and program backup
- To be used only with ABB Ability™ Automation Builder 2.1 and later
- Support of AC500-S safety PLC.

Total user program memory MB (4) (5)	Cycle time in μ s per instruction min. Bit/Word/Float. point	Integrated communication	Type	Order code	Weight (1 pce) kg
8 (thereof 1 for User Prog. code + Data)	0.020 / 0.020 / 0.120	2 x Ethernet with configurable protocol Ethernet/IP (2), 1 x serial, 1x CAN interface	PM5630-2ETH-XC (1) (3)	1SAP331000R0278	0.137
80 (thereof 4 for User Prog. code + Data)	0.010 / 0.010 / 0.010	2 x Ethernet with configurable protocol Ethernet/IP (2), 1 x serial, 1x CAN interface	PM5650-2ETH-XC (1) (3)	1SAP341000R0278	0.137
160 (thereof 16 for User Prog. code + Data)	0.002 / 0.002 / 0.002	2 x Ethernet with configurable protocol Ethernet/IP (2), 1 x serial, 1x CAN interface	PM5670-2ETH-XC (1) (3)	1SAP351000R0278	0.137
160 (thereof 16 for User Prog. code + Data) / 8GB Flash disk	0.002 / 0.002 / 0.002	2 x Ethernet with configurable protocol Ethernet/IP (2), 1 x serial, 1x CAN interface	PM5675-2ETH-XC (1) (3)	1SAP351500R0278	0.138

(1) Ethernet communication provides integrated web server, IEC 60870-5-104 remote control protocol and OPC UA server on each interface independently.

(2) Some communication protocols are licensed see following lines

(3) Only to be used with dedicated terminal base TB56xx-2ETH-XC

(4) Memory size of V2 versus V3 CPUs is not comparable. Projects have a different and separate User Program code and Data memory calculation in Automation Builder 2.4.0 version or later. System, configuration and web server parts are not counted anymore. This results in typically about 50 % lower memory usage compared to V2, and even lower memory usage compared to V3 projects compiled in Automation Builder 2.3.0 or before.

(5) Total user program memory: Defines the CPU type and the size of user part, but the most relevant and real information is given by the maximum downloadable application size of each CPU (see technical data).



PM5630-2ETH-XC



PM5650-2ETH-XC



PM5670-2ETH-XC



PM5675-2ETH-XC

AC500-XC

Ordering data

AC500 Runtime Licenses

For	Description	Type	Order code
all AC500 CPUs	Modbus TCP HA runtime license	PS5601-HA-MTCP	1SAP195400R0101
all AC500 V3 CPUs	IEC 61850 protocol runtime license	PS5602-61850	1SAP195600R0101
all AC500 V3 CPUs	KNX IP protocol runtime license	PS5604-KNX	1SAP195800R0101
all AC500 V3 CPUs	BACnet protocol B-BC runtime license	PS5607-BACnet-BC	1SAP195550R0101
all AC500 V3 CPUs	Data logger runtime license for AC500 V3	PS5609-Log	1SAP195002R0101
all AC500 V3 CPUs	Motion control library runtime license	PS5611-MC	1SAP192150R0101
all AC500 V3 CPUs	Ethernet/IP scanner runtime license for AC500 V3	PS5613-EIP-S	1SAP196101R0101
all AC500 V3 CPUs	Ethernet/IP adapter runtime license for AC500 V3	PS5613-EIP-A	1SAP196100R0101

For using runtime licensed features one license per CPU is required. The license has to be installed on the AC500 V3 CPU either by connecting it to Automation Builder or via Memory card that has been prepared by Automation Builder for license activation. The licenses can be transferred between AC500 V3 CPUs unlimited times.

AC500-XC

Ordering data

AC500-XC V3 terminal base

- For mounting and connection of the AC500-XC V3 CPUs only and communication modules
- 0, 1, 2, 4 or up to 6 plug-in communication modules
- Connection for communication coupler integrated in the CPU
- I/O interface for direct connection of up to 10 extension modules
- Connection COM1: 9-pole pluggable spring terminal block
- Connection CAN: 2x 5-pole pluggable spring terminal block
- 2x RJ45 Ethernet interfaces with configurable switch functionality

Number of coupler slots	Connection for coupler integrated in the CPU	Type	Order code	Weight (1 pce) kg
0	2x RJ45 for Ethernet, 1x serial COM1 with pluggable spring connector and 1x2x5 poles pluggable spring connector for CAN/CANopen interface	TB5600-2ETH-XC	1SAP310300R0278	0.131
1		TB5610-2ETH-XC	1SAP311300R0278	0.163
2		TB5620-2ETH-XC	1SAP312300R0278	0.188
4		TB5640-2ETH-XC	1SAP314300R0278	0.242
6		TB5660-2ETH-XC	1SAP316300R0278	0.314



TB5600-2ETH-XC



TB5610-2ETH-XC



TB5620-2ETH-XC



TB5640-2ETH-XC



TB5660-2ETH-XC

Terminal base compatibility

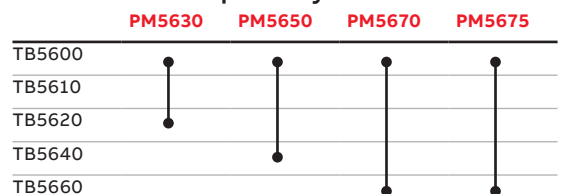

AC500-XC

Ordering data

Communication modules

Protocol	Connections	CPU V3 Support	Type	Order code	Weight (1 pce) kg
PROFIBUS DP V0/V1 master	D-Sub 9	Yes	CM592-DP-XC	1SAP373200R0001	0.101
PROFIBUS DP V0/V1 slave	D-Sub 9	Yes	CM582-DP-XC	1SAP372200R0001	0.101
Serial interface extender (4) (ASCII, Modbus RTU)	2 x RS232/485 on spring terminals	(2)	CM5610-2RS-XC	1SAP376000R0020	0.100
Ethernet (TCP/IP, UDP/IP, Modbus TCP)	2 x RJ45 - integrated switch	-	CM597-ETH-XC	1SAP373700R0001	0.102
Ethernet interface extender (3) (TCP/IP, Modbus TCP, OPC UA)	2 x RJ45 - 2 independent channels	(2)	CM5640-2ETH-XC	1SAP376000R0080	0.100
CANopen master	Terminal block 2 x 5 poles spring	(1)	CM598-CN-XC	1SAP373800R0001	0.095
CANopen slave	Terminal block 2 x 5 poles spring	-	CM588-CN-XC	1SAP372800R0001	0.095
PROFINET IO RT controller	2 x RJ45 - integrated switch	Yes	CM579-PNIO-XC	1SAP370901R0101	0.103
PROFINET IO RT device	2 x RJ45 - integrated switch	Yes	CM589-PNIO-XC	1SAP372900R0011	0.103
PROFINET IO RT with 4 devices	2xRJ45 - integrated switch	Yes	CM589-PNIO-4-XC	1SAP372900R0111	0.103

(1) Only with CAN 2A/2B protocol, the support CANopen Master protocol is in preparation.

(2) In preparation

(3) This communication module is a port extender for the used V3 CPU only, it adds 2 independent Ethernet channels driven by the CPU. That means the Ethernet limits of the CPU used apply for all onboard interfaces and added external interfaces (e.g. number of Modbus TCP clients of a CPU) will not be increased using the CM5640-2ETH but can then be splitted between onboard and external interfaces.

(4) This communication module is a port extender for the used V3 CPU only, it adds 2 independent serial interfaces driven by the CPU. That means the limits of the CPU used apply for all onboard interfaces and added external interfaces and can then be splitted between onboard and external interfaces.



CM592-DP-XC



CM579-PNIO-XC



CM5640-2ETH-XC

Protocol	Communication module	Communication interface module	I/O extension module		Applications	Support from CPU	
			S500-XC	S500-S-XC		V2	V3
Modbus TCP	Onboard Ethernet interface	CI521-MODTCP-XC / CI522-MODTCP-XC	●	-	HA, remote I/O, hot-swap I/O	●	●
	CM597-ETH-XC				HA, remote I/O, hot-swap I/O	●	-
	CM5640-2ETH-XC (1)		●	-	HA, remote I/O, hot-swap I/O	-	●
PROFIBUS DP	CM592-DP-XC master	CI541-DP-XC / CI542-DP-XC	●	-	remote I/O	●	● (1)
			●	-	hot-swap I/O	●	-
PROFINET IO RT	CM579-PNIO-XC controller	CI501-PNIO-XC / CI502-PNIO-XC	●	●	remote I/O, safety I/O	●	●
			●	-	hot-swap I/O	●	●
	CI504-PNIO-XC / CI506-PNIO-XC		●	●	remote I/O, safety I/O	●	-
			●	-	hot-swap I/O	●	-
CANopen	Onboard CAN interface	CI581-CN-XC / CI582-CN-XC	-	-	remote I/O	-	● (2)
	CM598-CN-XC master		●	-	remote I/O	●	-
CS31 bus	Onboard COM1 interface	DC505-CS31-XC / CI592-CS31-XC	●	-	remote I/O	●	-
		CI590-CS31-HA-XC			HA	●	-

(1) In preparation

(2) Only support of the I/O from the CI58x communication interface module, not additional S500 modules today supported

AC500-XC

Ordering data

I/O modules

- Hot swap capable when mounted on hot swap terminal unit
- For central extension of the AC500-XC CPU
- For decentralized extension in combination with communication interface module (not for DC505-FBP)
- DC and AC: channels can be configured individually as inputs or outputs
- Terminal unit required (refer to table below).

Digital I/O

Number of	Input signal	Output type	Output signal	Terminal units	Type	Order code	Weight (1 pce) kg
DI/DO/DC							
32 / - / -	24 V DC	-	-	TU516-XC	DI524-XC	1SAP440000R0001	0.101
- / - / 16	24 V DC	Transistor	24 V DC, 0.5 A	TU516-XC	DC522-XC	1SAP440600R0001	0.107
- / - / 24	24 V DC	Transistor	24 V DC, 0.5 A	TU516-XC	DC523-XC	1SAP440500R0001	0.118
16 / - / 16	24 V DC	Transistor	24 V DC, 0.5 A	TU516-XC	DC532-XC	1SAP440100R0001	0.114
- / 32 / -	-	Transistor	24 V DC, 0.5 A	TU516-XC	DO524-XC	1SAP440700R0001	0.110
8 / 8 / -	24 V DC	Relay	230 V AC, 3 A (1)	TU532-XC	DX522-XC	1SAP445200R0001	0.177
- / 8 / -	-	Transistor	24 V DC, 2 A	TU542-XC	DO526-XC	1SAP440800R0001	0.134

(1) Relay outputs, changeover contacts.



DI524-XC



DO524-XC

AC500-XC

Ordering data

Analog I/O

Number of	Input signal	Output signal	Terminal units	Type	Order code	Weight (1 pce) kg
AI/AO/AC						
16 / 0 / 0	0...10 V, ±10 V 0/4...20 mA	–	TU516-XC	AI523-XC	1SAP450300R0001	0.125
4 / 4 / 0	PT100, PT1000, Ni1000	±10 V	TU516-XC	AX521-XC	1SAP450100R0001	0.128
0 / 0 / 8 (max 4 current outputs)		0/4...20 mA	TU516-XC	AC522-XC	1SAP450500R0001	0.128
8 / 8 / 0 (max. 4 current outputs)			TU516-XC	AX522-XC	1SAP450000R0001	0.127
0 / 16 / 0 (max. 8 current outputs)			TU516-XC	AO523-XC	1SAP450200R0001	0.128
8 / 0 / 0	0...5 V, 0...10 V, ±50 mV, ±500 mV, 1 V, ±5 V, ±10 V, 0/4...20 mA, ±20 mA PT100, PT1000, Ni1000, Cu50, 0...50 kΩ, S, T, N, K, J	–	TU516-XC	AI531-XC	1SAP450600R0001	0.129

Analog/digital mixed I/O

Number of	Input signal	Output type	Output signal	Terminal unit	Type	Order code	Weight (1 pce) kg
AI/AO/DI/DO/DC							
4 / 2 / 16 / - / 8	24 V DC, 0...10 V, ±10 V, 0/4...20 mA, PT100,	Transistor	24 V DC, 0.5 A ±10 V,	TU516-XC	DA501-XC	1SAP450700R0001	0.122
4 / 2 / - / 16 / 8	PT1000, Ni100, Ni1000		0/4...20 mA	TU516-XC	DA502-XC	1SAP450800R0001	0.126

Function module

- Not hot swap capable

Functionality	Number of	Input signal	Output type	Output signal	Terminal unit	Type	Order code	Weight (1 pce) kg
DI/DO/DC								
Encoder and PWM module	2 / - / 8	24 V DC and 2 encoder inputs	2 PWM outputs	–	TU516-XC	CD522-XC	1SAP460300R0001	0.125

Fast I/O module for direct mounting on the terminal base of the AC500 CPU

Functionality	Number of	Input signal	Output type	Output signal	Terminal unit	Type	Order code	Weight (1 pce) kg
DI/DO/DC								
Interrupt I/O and fast counter	- / - / 8	24 V DC	Transistor	24 V DC, 0.5 A	N/A (2)	DC541-CM-XC (1) (3)	1SAP470000R0001	0.090

(1) Function module, refer to table on page 222 for details. Terminal block for I/O signal connection included.

(2) Occupies a communication module slot.

(3) The module is only supported by AC500 V2 CPU.



AI523-XC



AI531-XC



DA501-XC



DC522-XC



DC541-CM-XC

AC500-XC

Ordering data

Communication interface modules

Number of	Input signal	Output type	Output signal	Terminal units	Type	Order code	Weight (1 pce) kg
AI/AO/DI/DO/DC							
For CS31-Bus							
- / - / 8 / - / 16	24 V DC	Transistor	24 V DC, 0.5 A	TU552-CS31-XC	DC551-CS31-XC	1SAP420500R0001	0.125
- / - / - / - / 16	24 V DC	Transistor	24 V DC, 0.5 A	TU552-CS31-XC	CI590-CS31-HA-XC	1SAP421100R0001	0.124
4 / 2 / 8 / - / 8	24 V DC / 0...10 V, -10...+10 V, 0...20 mA, 4...20 mA, PT100, PT1000, Ni100, Ni1000	Transistor	24 V DC, 0.5 A / -10...+10 V, 0...20 mA, 4...20 mA	TU552-CS31-XC	CI592-CS31-XC	1SAP421200R0001	0.129
For PROFIBUS-DP							
4 / 2 / 8 / 8 / -	24 V DC / 0...10 V, -10...+10 V, 0...20 mA, 4...20 mA, PT100, PT1000, Ni100, Ni1000	Transistor	24 V DC, 0.5 A / -10...+10 V, 0...20 mA, 4...20 mA	TU510-XC / TU518-XC	CI541-DP-XC	1SAP424100R0001	0.139
- / - / 8 / 8 / 8	24 V DC	Transistor	24 V DC, 0.5 A	TU510-XC / TU518-XC	CI542-DP-XC	1SAP424200R0001	0.138
For CANopen							
4 / 2 / 8 / 8 / -	24 V DC / 0...10 V, -10...+10 V, 0...20 mA, 4...20 mA, PT100, PT1000, Ni100, Ni1000	Transistor	24 V DC, 0.5 A / -10...+10 V, 0...20 mA, 4...20 mA	TU510-XC / TU518-XC	CI581-CN-XC	1SAP428100R0001	0.139
- / - / 8 / 8 / 8	24 V DC	Transistor	24 V DC, 0.5 A	TU510-XC / TU518-XC	CI582-CN-XC	1SAP428200R0001	0.136
For Ethernet-based protocol - PROFINET IO RT							
4 / 2 / 8 / 8 / -	24 V DC / 0...10 V, -10...+10 V, 0...20 mA, 4...20 mA, PT100, PT1000, Ni100, Ni1000	Transistor	24 V DC, 0.5 A / -10...+10 V, 0...20 mA, 4...20 mA	TU508-ETH-XC	CI501-PNIO-XC	1SAP420600R0001	0.137
- / - / 8 / 8 / 8	24 V DC	Transistor	24 V DC, 0.5 A	TU508-ETH-XC	CI502-PNIO-XC	1SAP420700R0001	0.134
For Ethernet-based protocol - Modbus TCP							
4 / 2 / 8 / 8 / -	24 V DC / 0...10 V, -10...+10 V, 0...20 mA, 4...20 mA, PT100, PT1000, Ni100, Ni1000	Transistor	24 V DC, 0.5 A / -10...+10 V, 0...20 mA, 4...20 mA	TU508-ETH-XC	CI521-MODTCP-XC	1SAP422100R0001	0.138
- / - / 8 / 8 / 8	24 V DC	Transistor	24 V DC, 0.5 A	TU508-ETH-XC	CI522-MODTCP-XC	1SAP422200R0001	0.138

From	To	Output signal	Terminal units	Type	Order code	Weight (1 pce) kg
Gateway for Ethernet-based protocol - PROFINET IO RT						
PROFINET IO	-	3 x RS232/485 ASCII serial interfaces	TU520-ETH-XC	CI504-PNIO-XC	1SAP421300R0001	0.141
PROFINET IO	1 x CAN 2A/2B or CANopen Master	2 x RS232/485 ASCII serial interfaces	TU520-ETH-XC	CI506-PNIO-XC	1SAP421500R0001	0.142



DC551-CS31-XC



CI541-DP-XC



CI581-CN-XC



CI502-PNIO-XC



CI506-PNIO-XC



CI521-MODTCP-XC

AC500-XC

Ordering data

Hot swap terminal units

For loadless hot swapping of digital and analog extension modules, when used in configurations with communication interface modules or AC500 CPU supporting hot swap. Hot swapping of attached extension module mounted on hot swap terminal unit is supported by AC500 V3 CPU modules as of PM5630-2ETH, AC500 V2 CPU modules as of PM585-ETH, CI501-PNIO, CI502-PNIO, CI541-DP, CI542-DP, CI521-MODTCP and CI522-MODTCP. AC500-S safety I/O modules cannot be used in configurations containing hot swap terminal units. Mixed configurations of hot swap terminal units with normal terminal units for digital and analog extension modules are possible. In the installation hot swap terminal units can be identified by the word Hot Swap and a white frame around the connection terminal area.

For	Supply	Connection type	Type	Order code	Weight (1 pce) kg
I/O modules - for Hot Swap (2)	24 V DC	Spring	TU516-H-XC	1SAP415000R0001	0.160
I/O modules AC / Relay - for Hot Swap (2)	230 V AC	Spring	TU532-H-XC	1SAP415100R0001	0.167
I/O module DO526-XC - for Hot Swap (2)	24 V DC	Spring	TU542-H-XC	1SAP415200R0001	0.165

(2) I/O module as of index F0 needed for Hot Swap

Terminal units

For digital and analog extension modules and interface modules. Please note: for modules with relay outputs, terminal units for 230 V AC (TU532-XC) is required.

For	Supply	Connection type	Type	Order code	Weight (1 pce) kg
Ethernet interface modules	24 V DC	Spring	TU508-ETH-XC	1SAP414000R0001	0.170
CANopen/PROFIBUS DP interface modules	24 V DC	Spring	TU510-XC	1SAP410800R0001	0.161
I/O modules	24 V DC	Spring	TU516-XC	1SAP412000R0001	0.160
CANopen/PROFIBUS DP interface modules	24 V DC	Spring	TU518-XC (1)	1SAP411200R0001	0.162
Ethernet gateway modules	24 V DC	Spring	TU520-ETH-XC	1SAP414400R0001	0.146
I/O modules AC / Relay	230 V AC	Spring	TU532-XC	1SAP417000R0001	0.165
I/O module DO526-XC	24 V DC	Spring	TU542-XC	1SAP413200R0001	0.164
CS31 interface modules	24 V DC	Spring	TU552-CS31-XC	1SAP410400R0001	0.160

(1) TU518-XC Terminal units can also be used with PROFIBUS DP CI modules with baud rate up to 1Mbaud.

(2) I/O module as of index F0 needed for Hot Swap



TU516-XC



TU520-ETH-XC



TU510-XC



TU508-ETH-XC



TU516-H-XC

AC500-XC

Ordering data

Terminal units compatibility

Type	For I/O modules			For communication interface modules				
	TU516-XC TU516-H-XC	TU532-XC TU532-H-XC	TU542-XC TU542-H-XC	TU508-ETH-XC	TU510-XC	TU518-XC	TU520-ETH-XC	TU552-CS31-XC
DA501-XC	•							
DA502-XC	•							
DC522-XC	•							
DC523-XC	•							
DC532-XC	•							
DI524-XC	•							
DO524-XC	•							
DO526-XC			•					
DX522-XC		•						
CD522-XC	• (2)							
AC522-XC	•							
AI523-XC	•							
AI531-XC	•							
AO523-XC	•							
AX521-XC	•							
AX522-XC	•							
DC551-CS31-XC								•
CI590-CS31-HA-XC								•
CI592-CS31-XC								•
CI501-PNIO-XC				•				
CI502-PNIO-XC				•				
CI504-PNIO-XC							•	
CI506-PNIO-XC							•	
CI521-MODTCP-XC				•				
CI522-MODTCP-XC				•				
CI541-DP-XC					•			• (1)
CI542-DP-XC					•			• (1)
CI581-CN-XC								•
CI582-CN-XC								•

(1) Can be used with baudrate up to 1Mbaud.

(2) CD522-XC cannot be used on TU516-H-XC.

AC500-XC

Ordering data

Accessories for AC500-XC

For	Description	Type	Order code	Weight (1 pce) kg
AC500 CPUs	Memory card for high requirements (2 GB), for long term use e.g. data logging	MC5141	1SAP180100R0041	0.002
	Lithium battery for data buffering	TA521	1SAP180300R0001	0.009
I/O modules	Pluggable marker holder for I/O modules, packing unit includes 10 pcs. Template available in the AC500 online help	TA523	1SAP180500R0001	0.157
AC500 CPU's, interface module, communication module and I/O modules	White labels, packing unit includes 10 pcs	TA525	1SAP180700R0001	0.003
Terminal base	Communication Module, blind cap	TA524	1SAP180600R0001	0.059
CPU terminal base	Accessories for wall mounting, packing unit includes 10 pcs	TA526	1SAP180800R0001	0.074
	5-pole power plug for AC500. Spare part. Can be plugged to CPU terminal base TB5x1. Packing unit includes 5 pcs	TA527	1SAP181100R0001	0.300
	9-pole COM1 plug for AC500. Spare part. Can be plugged to CPU terminal base TB5x1 or on TU520-ETH-XC. Packing unit includes 5 pcs	TA528	1SAP181200R0001	0.400
Communication modules	9-pole spring plug for CM574-RS/RCOM. Spare part. Packing unit includes 10 pcs	TA532	1SAP182000R0001	0.400
	5-pole spring plug for CM575-DN/CM578-CN. Spare part. Packing unit includes 5 pcs	TA533	1SAP182100R0001	0.400
	2x5-pole spring plug for CM588-CN and CM598-CN. Spare part. Packing unit includes 5 pcs.	TA534	1SAP182200R0001	0.500
	10-pole spring plug for DC541-CM. Spare part. Packing unit includes 10 pcs.	TA536	1SAP183100R0001	0.500
Protective caps for TB, TU and CM	10 x Sub-D plastic caps 20 x RJ45 plastic caps, 3 x RJ45 female 10 x M12 plastic caps	TA535	1SAP182300R0001	0.051
AC500 CPUs PM595	Protective cap, spare-parts, Packing unit includes 3 pcs	TA540	1SAP182600R0001	0.050
	Lithium battery for real-time-clock buffering	TA541	1SAP182700R0001	0.020
	Accessories for screw-mounting, Packing unit includes 20 pcs	TA543	1SAP182800R0001	0.010



MC5141



TA527



TA528



TA540

AC500-XC

Technical data

AC500-XC CPUs

Type	PM573-ETH-XC	PM582-XC	PM583-ETH-XC
Supply voltage	24 V DC		
Current consumption on 24 V DC			
Min. (module alone)	0.110 A	0.050 A	0.110 A
Max. (all couplers and I/Os)	0.810 A	0.750 A	0.810 A
Type of processor	Freescale ARM Processor 32-bit		
Processor clock frequency	50 MHz	84 MHz	84 MHz
Total RAM memory	32 MB	32 MB	32 MB
Total Flash memory	16 MB	16 MB	16 MB
Total user program memory (2)	2048 kB	928 kB	6144 kB
User program memory - Flash EPROM and RAM	512 kB	512 kB	1024 kB
Integrated user data memory	512 kB thereof 288 kB saved	416 kB thereof 288 kB saved	1024 kB thereof 288 kB saved
User flash disk (Data-storage, program access or also external with FTP)	-		
Plug-in memory card	Depending on memory card used: no SD-HC card allowed, use MC5141 for high requirements		
Web server's data for user RAM disk	1 024 kB	-	4 096 kB
Data buffering	battery		
Real-time clock (with battery back-up)	●		
Cycle time for 1 instruction (minimum)			
Binary	0.06 µs	0.05 µs	
Word	0.09 µs	0.06 µs	
Floating-point	0.7 µs	0.5 µs	
Max. number of centralized inputs/outputs			
Max. number of extension modules on I/O bus	up to max. 10 (S500 allowed)		
Digital inputs / outputs	320 / 320		
Analog inputs / outputs	160 / 160		
Max. number of decentralized inputs/outputs	depends on the used standard fieldbus (1)		
Program execution			
Cyclical / Time controlled / Multi tasking	● / ● / ●		
User program protection by password	●		
Internal interfaces			
COM1			
RS232 / RS485 configurable	●		
Connection (on terminal bases)	pluggable spring terminal block, use TK502 cable in accessory		
Programming, Modbus RTU, ASCII, CS31 master	●		
COM2			
RS232 / RS485 configurable	●		
Connection (on terminal bases)	D-Sub 9 female, use TK501 cable in accessory		
Programming, Modbus RTU, ASCII	●		
FieldBusPlug			
Serial neutral interface	●		
Connection (on terminal bases)	M12 male, 5 pole		
Functions	programming cable UTF-21-FBP, slave communication depending on FieldBusPlug used (PROFIBUS DP, CANopen, DeviceNet)		
Ethernet			
Ethernet connection (on terminal bases)	RJ45	-	RJ45
Ethernet functions: online Access, ICMP (Ping), DHCP, IP configuration protocol, UDP data exchange, Modbus TCP, HTTP (integrated Web server), IEC 60870-5-104 remote control protocol, MQTT, SNTP (Time synchronization), FTP server, SMTP client, Socket programming	●	-	●
Ethernet-based fieldbus			
Ethernet connection (on CPU module)	-		
Downloadable protocols like: PROFINET IO RT Controller, EtherCAT Master	-		
CPU Display	LC display and 8 function keys		
Function	RUN / STOP, status, diagnosis		
RUN / STOP, RESET push buttons	-		
LEDs for various status display	-		
Timers / Counters	unlimited / unlimited		
Approvals	See detailed page 284 or new.abb.com/plc		

(1) e.g. CS31 fieldbus: up to 31 stations with up to 120 DIs / 120 DOs or up to 32 AIs / 32 AOs per station.

(2) Total user program memory: contains user program code, data and web server

AC500-XC

Technical data

AC500-XC CPUs

Type	PM591-ETH-XC	PM592-ETH-XC	PM595-4ETH-M-XC
Supply voltage	24 V DC		
Current consumption on 24 V DC			
Min. (module alone)	0.150 A		0.400 A
Max. (all couplers and I/Os)	0.850 A		1.2 A
Type of processor	Freescale ARM Processor 32-bit		
Processor clock frequency	400 MHz	400 MHz	1 GHz
Total RAM memory	64 MB	64 MB	256 MB
Total Flash memory	32 MB	32 MB	64 MB
Total user program memory (2)	17920 kB		64 MB
User program memory - Flash EPROM and RAM	4096 kB		16384 kB
Integrated user data memory	5632 kB thereof 1536 kB saved		16384 kB thereof 3072 kB saved
User Flash disk (Data-storage, program access or also external with FTP)	–	Yes, 4 GB Flash non removable	
Plug-in memory card	Depending on memory card used: no SD-HC card allowed, use MC5141 for high requirements		
Web server's data for user RAM disk	8 MB		32 MB
Data buffering	battery		no battery needed
Real-time clock (with battery back-up)	●		
Cycle time for 1 instruction (minimum)			
Binary	0.002 μs		0.0006 μs
Word	0.004 μs		0.001 μs
Floating-point	0.004 μs		0.001 μs
Max. number of centralized inputs/outputs			
Max. number of extension modules on I/O bus	up to max. 10 (S500 allowed)		
Digital inputs / outputs	320 / 320		
Analog inputs / outputs	160 / 160		
Max. number of decentralized inputs/outputs	depends on the used standard fieldbus (1)		
Program execution			
Cyclical / Time controlled / Multi tasking	● / ● / ●		
User program protection by password	●		
Internal interfaces			
COM1			
RS232 / RS485 configurable	●		
Connection (on terminal bases)	pluggable spring terminal block, use TK502 cable in accessory		
Programming, Modbus RTU, ASCII, CS31 master	●		
COM2			
RS232 / RS485 configurable	●		
Connection (on terminal bases)	D-sub 9 female, use TK501 cable in accessory		
Programming, Modbus RTU, ASCII	●		
FieldBusPlug			
Serial neutral interface	●		–
Connection (on terminal bases)	M12 male, 5 pole		–
Functions	programming cable UTF-21-FBP, slave communication depending on FieldBusPlug used (PROFIBUS DP, CANopen, DeviceNet)		–
Ethernet			
Ethernet connection (on terminal bases)	RJ45	RJ45	2x RJ45
Ethernet functions: online Access, ICMP (Ping), DHCP, IP configuration protocol, UDP data exchange, Modbus TCP, HTTP (integrated Web server), IEC 60870-5-104 remote control protocol, MQTT, SNTP (Time synchronization), FTP server, SMTP client, Socket programming	●	●	●
Ethernet-based fieldbus			
Ethernet connection (on CPU module)	–		4 x RJ45 (2x interfaces with 2-port switch)
Downloadable protocols like: PROFINET IO RT Controller / EtherCAT Master or Ethernet e.g. Modbus TCP client/server	–		●
CPU display	LC display and 8 function keys		–
Function	RUN / STOP, status, diagnosis		Status, diagnosis
RUN / STOP, RESET push buttons	–		●
LEDs for various status display	–		●
Timers / Counters	unlimited / unlimited		
Approvals	See detailed page 284 or new.abb.com/plc		

(1) e.g. CS31 fieldbus: up to 31 stations with up to 120 DIs / 120 DOs or up to 32 AIs / 32 AOs per station.

(2) Total user program memory: contains user program code, data and web server

AC500-XC

Technical data

AC500-XC V3 CPUs

Type	PM5630-2ETH-XC	PM5650-2ETH-XC	PM5670-2ETH-XC	PM5675-2ETH-XC
Supply voltage	24 V DC			
Current consumption on 24 V DC				
Min. typ. (module alone)	0.110 A	0.120 A	0.140 A	
Max. typ. (all couplers and I/Os)	0.850 A	0.900 A	0.950 A	
Type of processor	TI ARM Cortex-A9 32-bit-RISC			
Processor clock frequency	300 MHz	600 MHz	1 GHz	1 GHz
Total RAM memory	128 MB	256 MB	512 MB	512 MB
Total Flash memory	128 MB	512 MB	1024 MB	1024 MB
User program memory	8 MB	80 MB	160 MB	160 MB
Maximum downloadable application size (4)	9 MB	84 MB	176 MB	176 MB
Thereof User program code and data (1) (dynamically allocated)	2 MB (2)	8 MB (2)	32 MB (2)	32 MB (2)
Thereof User web server Data max.	6 MB	72 MB	128 MB	128 MB
User data memory saved	256 kB	256 kB	1.5 MB	1.5 MB
Thereof VAR Retain persistent	128 kB	128 kB	1024 kB	1024 kB
Thereof %M memory (e.g. Modbus register memory)	128 kB	128 kB	512 kB	512 kB
User flash disk (Data-storage, programm access or also external with FTP)				8 GB Flash non removable
Plug-in memory card	use MC5141 for high requirements preferably			
Data buffering	battery			
Real-time clock (with battery back-up)	●			
Cycle time for 1 instruction (minimum)				
Binary	0.02 μs	0.01 μs	0.002 μs	0.002 μs
Word	0.02 μs	0.01 μs	0.002 μs	0.002 μs
Floating-point	0.12 μs	0.01 μs	0.002 μs	0.002 μs
Program execution				
Cyclical	●			
Minimun cycle time configurable for cyclical task	1 ms	1 ms	0.5 ms	
Time controlled	●			
Multi tasking	●			
User program protection by password	●			
Motion control with EtherCAT or CAN sync onboard and PLCopen library PS5611-MC (5)				
Min. EtherCAT master cycle time	2 ms	1 ms	0.5 ms	
Number of synchronized axis (3) in 1 ms	-	8	16	
Number of synchronized axis (3) in 2 ms	4	16	32	
Number of synchronized axis (3) in 4 ms	8	32	64	
Communication modules and terminal bases supported				
Max. number of communication modules on terminal base TB				
TB5600-2ETH-XC	0 slot	0 slot	0 slot	
TB5610-2ETH-XC	1 slot	1 slot	1 slot	
TB5620-2ETH-XC	2 slots	2 slots	2 slots	
TB5640-2ETH-XC	-	4 slots	4 slots	
TB5660-2ETH-XC	-	-	6 slots	

(1) Total user program memory: Defines the CPU type and the size of User part but the most relevant and real information is given by the maximum downloadable application size of each CPU.

(2) Memory size of V2 versus V3 CPUs is not comparable. Projects have a different and separate User Program code and Data memory calculation in Automation Builder 2.4.0 version or later: System, configuration and web server parts are not counted anymore. This results in typically about 50 % lower memory usage compared to V2, and even lower memory usage compared to V3 projects compiled in Automation Builder 2.3.0 or before.

(3) + 1 e.g. for virtual axis

(4) Maximum downloadable application size: contains user program code, data, web server memory, infrastructure. This is the maximum size of the application which can be downloaded into a CPU with Automation Builder. This value is displayed and splitted into different categories in the resource window of AB SW.

(5) Licensed

AC500-XC

Technical data

AC500-XC V3 CPUs

Type	PM5630-2ETH-XC	PM5650-2ETH-XC	PM5670-2ETH-XC	PM5675-2ETH-XC
Type of safety module supported				
SM560-S-XC - safety module	●			
SM560-S-FD-1-XC - safety module with F-Device functionality for 1 PROFIsafe network	●			
SM560-S-FD-4-XC- safety module with F-Device functionality for 1 PROFIsafe network	●			
Type of communication module supported				
Max. number of variables allowed for each communication module supported				
Input variables	4 kB		5 kB	
Output variables	4 kB		5 kB	
CM582-DP-XC - PROFIBUS DP V0/V1 Slave	●			
CM592-DP-XC - PROFIBUS DP V0/V1 Master	●			
CM5610-2RS-XC - serial interface	● (2)			
CM579-PNIO-XC - PROFINET IO RT controller	●			
CM589-PNIO-XC - PROFINET IO RT device	●			
CM589-PNIO-4-XC - PROFINET IO RT with 4 devices	●			
CM5640-2ETH-XC - 2 Ethernet interfaces (3) (4)	● (2)			
CM597-ETH-XC - Ethernet interface	-			
CM588-CN-XC - CAN, CANopen Slave	-			
CM598-CN-XC - CAN, CANopen Master	● only CAN 2A/2B today			
Max. number of centralized inputs/outputs				
Max. number of extension modules on I/O bus up to max. 10 (S500 and/or S500-eCo I/O modules allowed)				
Digital	inputs/outputs		320/320	
Analog	inputs/outputs		160/160	
Max. number of decentralized inputs/outputs depends on the used standard fieldbus (1)				
Internal interfaces for communication				
COM1				
RS232 / RS485 configurable	●			
Connection (on terminal bases or CPU module)	pluggable spring terminal block			
Modbus RTU Master/Slave, ASCII	●			
CANopen				
Serial interface	CAN serial interface			
Connection (on terminal bases)	Pluggable spring terminal block, 2x 5 poles			
Functions	CANopen® Master communication, CAN 2A/2B, J1939 protocol, CAN sync			
Max. number of variables allowed				
Input variables	2 kB	4 kB	5 kB	
Output variables	2 kB	4 kB	5 kB	
Ethernet				
2x independent Ethernet interfaces for several uses				
Ethernet connection (on terminal bases)	2x RJ45 with 2x separated interfaces and MAC-Address, could be used as 2-port switch with 1x interface			
Ethernet functions (3):				
Ethernet Switch on ETH1 / ETH2	●			
Online Access, ICMP (Ping), DHCP, programming	●			
Nb of parallel connections	6	8	12	
IP configuration protocol	●			
UDP data exchange, Network variables	● / ●			

(1) e.g. CANopen fieldbus: up to 127 stations with I/O from CI module only per station.

(2) In preparation, availability on demand

(3) Using parallel protocols on the same and/or different port reduces the bandwidth and the CPU performance

(4) The CM5640-2ETH communication module is a port extender providing 2 additional "onboard Ethernet" interfaces to the connected CPU which manages all the communication. Some of the onboard Ethernet features are available, the Ethernet limitations from the CPU will then apply in total for all the connected interfaces. The CM5640-2ETH doesn't extend the limits which remain those of the connected CPU, e.g. no increase of Ethernet sockets or number of OPC UA tags.

AC500-XC

Technical data

AC500-XC V3 CPUs

Type	PM5630-2ETH-XC	PM5650-2ETH-XC	PM5670-2ETH-XC	PM5675-2ETH-XC
HTTP / HTTPs (integrated web server)	●			
Nb of parallel connections	4	8	12	
Web Visu for data visualisation on web server HTML5	●			
SNTP (Time synchronization)	●			
FTP / FTPs server	●			
Nb of parallel connections	2	4	4	
SMTP client	●			
Socket programming	●			
Modbus TCP Client / Server	● / ●			
Nr of Modbus clients ModMast in parallel on a CPU Master (Server)	30	50	120	
Nr of Modbus server in parallel (for SCADA access e.g.)	15	25	50	
IEC 60870-5-104 remote control protocol - Support 2nd connection	●			
Nr of free tags	1000	5000	10000	
Control Station - Nb connections	5	10	20	
Sub-Station - Nb connections	5	10	20	
OPC UA Server (Micro Embedded Device Server) with security	●			
Nr of free tags	3000	10000	30000	
Nr of Connections	10	20	50	
min sampling rate (limit)	500 ms	100 ms	50 ms	
OPC DA Server AE	●			
Nr of Connections	8	8	8	
Ethernet-based fieldbus protocols on onboard Ethernet interface (2)	The number of allowed variables is depending on the protocol used			
Downloadable protocols (licensed feature with runtime license per CPU):	available on one Ethernet interface, the other interface can be sometimes used as switch			
Ethernet/IP Scanner communication	● (1)	● (1)	● (1)	
Ethernet/IP Adapter communication	● (1)	● (1)	● (1)	
Maximum allowed number of input/output variables for the onboard fieldbus protocol	0.5 kB / 0.5 kB	0.5 kB / 0.5 kB	0.5 kB / 0.5 kB	
IEC 61850 - MMS server Edition 1 / GOOSE communication	● / ● (1)	● / ● (1)	● / ● (1)	
Maximum number of allowed variables in variables list	1000	5000	10000	
KNX - Building communication	● (1)	● (1)	● (1)	
Maximum number of allowed Objects variables on the interface	1000	1000	1000	
BACnet-BC - Infrastructure communication	● (1)	● (1)	● (1)	
Maximum number of allowed Objects variables on the interface	1000	1000	1000	
CPU display	LC display and 8 function keys			
Function	RUN / STOP, status, diagnosis, settings			
LEDs for various status display	●			
Timer/Counter	unlimited/unlimited			
Approvals	See detailed page 284 or new.abb.com/plc			

(1) Feature is licensed, runtime license per CPU.

(2) Using parallel protocols on the same and/or different port reduces the bandwidth and the CPU performance

AC500-XC

Technical data

Digital S500-XC I/O modules

Type	DI524-XC	DC522-XC	DC523-XC	DC532-XC	DO524-XC	DO526-XC	DX522-XC		
Number of channels per module									
Digital	inputs	32	–	–	16	–	–	8	
	outputs	–	–	–	–	32	8	8 relays	
Configurable channels DC (configurable as inputs or outputs)		–	16	24	16	–	–	–	
Additional configuration of channels as									
Fast counter		configuration of max. 2 channels per module, operating modes see table on page 236							
Occupies max. 1 DO or DC when used as counter		–	●	●	●	–	–	–	
Connection via terminal unit		●	●	●	●	●	●	●	
Digital inputs									
Input signal voltage		24 V DC				–	–	24 V DC	
Input characteristic acc. to EN 61132-2		Type 1				–	–	Type 1	
0 signal		-3...+5 V DC				–	–	-3...+5 V DC	
Undefined signal state		5...15 V DC				–	–	5...15 V DC	
1 signal		15...30 V DC				–	–	15...30 V DC	
Input time delay (0 -> 1 or 1 -> 0)		8 ms typically, configurable from 0.1 up to 32 ms				–	–	8 ms typically, configurable from 0.1 up to 32 ms	
Input current per channel									
At input voltage		24 V DC	5 mA typically		–	–	–	5 mA typically	
		5 V DC	> 1 mA		–	–	–	> 1 mA	
		15 V DC	> 5 mA		–	–	–	> 5 mA	
		30 V DC	< 8 mA		–	–	–	< 8 mA	
Digital outputs									
Transistor outputs 24 V DC		–	●	●	●	●	●	–	
Readback of output		–	●	●	●	–	–	–	
Relay outputs, supplied via process voltage UP, changeover contacts		–	–	–	–	–	–	●	
Switching of load		24 V	–	●	●	●	●	●	
		230 V	–	–	–	–	–	●	
Output voltage at signal state 1		–	process voltage UP minus 0.8 V				–	–	process voltage UP minus 0.4 V
Output current									
Nominal current per channel		–	500 mA at UP = 24 V				2 A at UP = 24 V	–	
Maximum (total current of all channels)		–	8 A				16 A	–	
Residual current at signal state 0		–	< 0.5 mA				–	–	
Demagnetization when switching off inductive loads		–	by internal varistors				–	–	
Switching frequency									
For inductive load		–	0.5 Hz max.			0.5 Hz max.	–	2 Hz	
For lamp load		–	11 Hz max. at max. 5 W				–	–	
Short-circuit / overload proofness		–	●	●	●	●	–	by external fuse / circuit breaker 6 A gL/gG per channel	
Overload indication (I > 0.7 A)		–	after approx. 100 ms				–	–	
Output current limiting		–	yes, with automatic reclosure				–	–	
Proofness against reverse feeding of 24 V signals		–	●	●	●	●	–	–	
Contact rating									
For resistive load, max.		–	–				–	–	3 A at 230 V AC 2 A at 24 V DC
For inductive load, max.		–	–				–	–	1.5 A at 230 V AC 1.5 A at 24 V DC
For lamp load		–	–				–	–	60 W at 230 V AC 10 W at 24 V DC

AC500-XC

Technical data

Digital S500-XC I/O modules

Type	DI524-XC	DC522-XC	DC523-XC	DC532-XC	DO524-XC	DO526-XC	DX522-XC
Lifetime (switching cycles)							
Mechanical lifetime	–						300 000
Lifetime under load	–						300 000 at 24 V DC / 2 A 200 000 at 120 V AC / 2 A 100 000 at 230 V AC / 3 A
Spark suppression for inductive AC load	–						external measure depending on the switched load
Demagnetization for inductive DC load	–						external measure: free-wheeling diode connected in parallel to the load
Process voltage UP							
Nominal voltage	24 V DC						
Current consumption on UP							
Min. (module alone)	0.150 A	0.100 A	0.150 A	0.150 A	0.050 A	0.050 A	0.050 A
Max. (min. + loads)	0.150 A	0.100 A + load	0.150 A + load	0.150 A + load	0.100 A + load	0.050 A + load	0.050 A + load
Reverse polarity protection	●	●	●	●	●	●	●
Fuse for process voltage UP	10 A miniature fuse						
Connections for sensor voltage supply. Terminal 24 V and 0 V for each connection. Permitted load for each group of 4 or 8 connections: 0.5 A	–	8	4	–	–	–	–
Short-circuit and overload proof 24 V DC sensor supply voltage	–	●	●	–	–	–	–
Maximum cable length for connected process signals							
Cable	shielded	1000 m					
	unshielded	600 m					
Potential isolation							
Per module	●						
Between channels	input	–	–	–	–	–	–
	output	–	–	–	–	–	in groups of 4 ●
Voltage supply for the module	internally via extension bus interface (I/O bus)						
Fieldbus connection	via AC500-XC CPU or all communication interface modules (except DC505-FBP fieldbus Plug module)						
Address setting	automatically (internal)						

AC500-XC

Technical data

Analog S500-XC I/O modules

Type		AX521-XC	AX522-XC	AC522	AI523-XC	AO523-XC	AI531-XC	
Number of channels per module								
Individual configuration, analog	inputs	4	8	–	16	–	8	
	outputs	4	8	–	–	16	–	
	configurable	–	–	8	–	–	–	
Signal resolution for channel configuration								
-10...+10 V		13 bits including sign						16 bits including sign
0...10 V		12 bits						15 bits
0...20 mA, 4...20 mA		12 bits						15 bits
Temperature: 0.1 °C		●	●	●	●	–	●	
Monitoring configuration per channel								
Plausibility monitoring		●	●	●	●	●	●	
Wire break & short-circuit monitoring		●	●	●	●	●	●	
Analog Inputs AI								
Signal configuration per AI		max. number per module and with regard to the configuration: AIs / Measuring points (depending on the use of 2/3-wire connection or differential input)						
0...10 V		4 / 4	8 / 8	8 / 8	16 / 16	–	8 / 8	
-10...+10 V		4 / 4	8 / 8	8 / 8	16 / 16	–	8 / 8	
0...20 mA		4 / 4	8 / 8	8 / 8	16 / 16	–	8 / 8	
4...20 mA		4 / 4	8 / 8	8 / 8	16 / 16	–	8 / 8	
Pt100								
-50...+400 °C (2-wire)		4 / 4	8 / 8	8 / 8	16 / 16	–	8 / 8	
-50...+400 °C (3-wire), 2 channels		4 / 2	8 / 4	8 / 4	16 / 8	–	8 / 8	
-50...+400 °C (4-wire)		–	–	–	–	–	8 / 8	
-50...+70 °C (2-wire)		4 / 4	8 / 8	8 / 8	16 / 16	–	8 / 8	
-50...+70 °C (3-wire), 2 channels		4 / 2	8 / 4	8 / 4	16 / 8	–	8 / 8	
-50...+70 °C (4-wire)		–	–	–	–	–	8 / 8	
Pt1000								
-50...+400 °C (2-wire)		4 / 4	8 / 8	8 / 8	16 / 16	–	8 / 8	
-50...+400 °C (3-wire), 2 channels		4 / 2	8 / 4	8 / 4	16 / 8	–	8 / 8	
-50...+400 °C (4-wire)		–	–	–	–	–	8 / 8	
Ni1000								
-50...+150 °C (2-wire)		4 / 4	8 / 8	8 / 8	16 / 16	–	8 / 8	
-50...+150 °C (3-wire), 2 channels		4 / 2	8 / 4	8 / 4	16 / 8	–	8 / 8	
-50...+150 °C (4-wire)		–	–	–	–	–	8 / 8	
Cu50 -200...+200 °C		–	–	–	–	–	8 / 8	
Resistor 0...50 kΩ		–	–	–	–	–	8 / 8	
Thermocouples of types J, K, T, N, S		–	–	–	–	–	8 / 8	
0...10 V using differential inputs, 2 channels		4 / 2	8 / 4	8 / 4	16 / 8	–	8 / 8	
-10...+10 V using differential inputs, 2 channels		4 / 2	8 / 4	8 / 4	16 / 8	–	8 / 8	
Digital signals (digital input)		4 / 4	8 / 8	8 / 8	16 / 16	–	8 / 8	
Input resistance per channel		voltage: > 100 kΩ current: approx. 330 Ω				–	voltage: > 100 kΩ current: approx. 330 Ω	
Time constant of the input filter		voltage: 100 μs current: 100 μs				–	voltage: 100 μs current: 100 μs	
Conversion cycle		2 ms (for 8 AI + 8 AO), 1 s for Pt100/1000, Ni1000				–	1 ms (for 8 AI + 8 AO), 1 s for Pt100/1000, Ni1000	
Overvoltage protection		●	●	●	●	–	●	

AC500-XC

Technical data

Analog S500-XC I/O modules

Type		AX521-XC	AX522-XC	AC522	AI523-XC	AO523-XC	AI531-XC	
Data when using the AI as digital input								
Input	time delay	8 ms typically, configurable from 0.1 up to 32 ms				–	8 ms typically, configurable from 0.1 up to 32 ms	
	signal voltage	24 V DC				–	24 V DC	
Signal	0	-30...+5 V				–	-30...+5 V	
	1	13...30 V				–	13...30 V	
Analog outputs AO								
Possible configuration per AO		Max. number of AOs per module and with regard to the configuration:						
	-10...+10 V	4	8	8	–	16	–	
	0...20 mA	4	4	4	–	8	–	
	4...20 mA	4	4	4	–	8	–	
Output	resistance (burden) when used as current output	0...500 Ω				–	0...500 Ω	
	loading capability when used as voltage output	Max. ±10 mA				–	Max. ±10 mA	
Full scale conversion error								
Basic error at 25 °C								
	Analog input	±0.5 %				–	±0.1 % (voltage) ±0.3 % (current, resistor)	
	Analog output	±0.5 %				–	±0.5 %	
Maximum error over the full range								
	Analog input	±1 %				–	±0.7 % (voltage) ±0.9 % (current, resistor)	
	Analog output	±1 %				–	±1 %	
Process voltage UP								
Nominal voltage		24 V DC						
Current consumption on UP								
	Min. (module alone)	0.150 A					0.130 A	
	Max. (min. + loads)	0.150 A + load	0.150 A + load		–	0.150 A + load		
Reverse polarity protection		•	•	•	•	•	•	
Max. line length of the analog lines, conductor cross section > 0.14 mm ²		100 m						
Potential isolation								
Per module		•	•	•	•	•	–	
Fieldbus connection		Via AC500-XC CPU or all communication interface modules (except DC505-FBP)						
Voltage supply for the module		Internally via extension bus interface (I/O bus)						

AC500-XC

Technical data

CD522-XC encoder module

The CD522-XC module offers accuracy and dynamic flexibility for a customized solution. It has two independent encoder inputs onboard and is easily configured using the Automation Builder software for 10 different operation modes and for frequencies up to 300 kHz. The CD522-XC module also integrates outputs for pulses and for PWM as well as normal inputs and outputs, depending on selected encoder mode.

Type		CD522-XC
Functionality		
Digital inputs/outputs		24 V DC, dedicated inputs/outputs can be used for specific counting functions. All unused inputs/outputs can be used as input/output with standard specification.
	Input options	Catch/Touch operation, counter value stored in separate variable on external event (rising or falling) Set to preset counter register with predefined value Set to reset counter register
	End value output	Output set when predefined value is reached
	Reference point initialization (RPI) input for relative encoder initialization	•
High-speed counter/encoder		
Integrated counters	Counter characteristics	2 counters (24 V DC, 5 V DC, differential and 1 Vpp sinus input)
	Counter mode	one 32 bits or two 16 bits
	Relative position encoder	X1, X2, X3
	Absolute SSI encoder	•
	Time frequency meter	•
	Frequency input	up to 300 kHz
PWM/pulse outputs		
Output mode specification	Number of outputs	2
	Push pull output	24 V DC, 100 mA max
	Current limitation	Thermal and overcurrent
PWM mode specification	Frequency	1...100 kHz
	Value	0...100 %
Pulse mode specification	Frequency	1...15 kHz
	Pulse emission	1...65535 pulses
	Number of pulses emitted indicator	0...100 %
Frequency mode specification	Frequency output	100 kHz
	Duty Cycle	Set to 50 %
Number of channels per module		
Digital	input	2
	output	2
Configurable channels DC (configurable as inputs or outputs)		8
Additional configuration of channels as		
Fast counter		Integrated 2 counter encoders
Connection via terminal unit		•
Digital Inputs		
Input	signal voltage	24 V DC
	time delay	8 ms typically configurable from 0.1 up to 32 ms
Input current per channel		
At input voltage	24 V DC	Typically 5 mA
	5 V DC	> 1 mA
	15 V DC	> 5 mA
	30 V DC	< 8 mA

AC500-XC

Technical data

CD522-XC encoder module

Type	CD522-XC	
Digital outputs		
Output voltage at signal state 1	UP – 0.8 V	
Output current		
Nominal current per channel	0.5 A	
Maximum (total current of all channels)	8 A	
Residual current at signal state 0	< 0.5 mA	
Demagnetization when switching off inductive loads	By internal varistors	
Switching frequency		
For inductive load	Max. 0.5 Hz	
For lamp load	Max. 11 Hz with max. 5 W	
Short-circuit / Overload proofness	●	
Overload indication (I > 0.7 A)	After approx. 100 ms	
Output current limiting	●	
Proofness against reverse feeding of 24 V signals	●	
Maximum cable length for connected process signals		
Cable	shielded	1000 m
	unshielded	600 m
Potential isolation		
Per module	●	
Technical data of the high-speed inputs		
Number of channels per module	6	
Input type	24 V DC, 5 V DC / Differential / Sinus 1 Vpp	
Frequency	300 kHz	
Technical data of the fast outputs		
Number of channels	2	
Indication of the output signals	Brightness of the LED depends on the number of pulses emitted (0 % to 100 %) (pulse output mode only)	
Output current		
Rated value, per channel	100 mA at UP = 24 V	
Maximum value (all channels together, configurable outputs included)	8 A	
Leakage current with signal 0	< 0.5 mA	
Rated protection fuse on UP	10 A fast	
De-magnetization when inductive loads are switched off	with varistors integrated in the module	
Overload message (I > 0.1 x A)	Yes, after ca. 100 ms	
Output current limitation	Yes, automatic reactivation after short-circuit/overload	
Resistance to feedback against 24 V signals	Yes	
Process voltage UP		
Nominal voltage	24 V DC	
Current consumption on UP		
Min. (module alone)	0.070 A	
Max. (min. + loads)	0.070 A + load	
Reverse polarity protection	●	
Fuse for process voltage UP	10 A miniature fuse	

AC500-XC

Technical data

Analog/digital mixed I/O extension module

For all modules: max cable length for connected process signals is 1000 m for shielded cable and 600 m for unshielded ones. For all Input modules, the signal resolution for channel configuration is: -10...+10 V: 13 bits including sign; 0...10 V, 0...20 mA, 4...20 mA: 12 bits.

Type	DA501-XC	DA502-XC
Number of Channels per Module		
Digital		
inputs	16	–
outputs	–	16
Analog		
inputs	4	4
outputs	2	2
Digital configurable channels DC (configurable as inputs or outputs)	8	8
Additional configuration of channels as		
Fast counter	Yes	
Occupies max. 1 DO or DC when used as counter	Configuration of max. 2 channels per module. Operating modes see table on page 236	
Connection via terminal unit TU 5xx	●	
Digital inputs		
Input	signal voltage	24 V DC
	characteristic acc. to EN 61132-2	Type 1
0 signal		-3...+5 V DC
Undefined signal state		5...15 V DC
1 signal		15...30 V DC
Residual ripple, range for	0 signal	-3...+5 V DC
	1 signal	15...30 V DC
Input time delay (0 -> 1 or 1 -> 0)	8 ms typically, configurable from 0.1 up to 32 ms	
Digital outputs		
Transistor outputs 24 V DC, 0.5 A	●	
Readback of output	●	
Outputs, supplied via process voltage UP	●	
Switching of 24 V load	●	
Output voltage at signal state 1	Process voltage UP - 0.8 V	
Output current		
Nominal current per channel	500 mA at UP = 24 V DC	
Maximum (total current of all channels)	4 A	8 A
Residual current at signal state 0	< 0.5 mA	
Demagnetization when switching off inductive loads	By internal varistors	
Analog inputs AI	Max. number per module and with regard to the configuration: AIs / Measuring points	
Signal configuration per AI	●	
0...10 V / -10 ... +10 V	4 / 4	
0...20 mA / 4...20 mA	4 / 4	
RTD using 2/3 wire needs 1/2 channel(s)	4 / 2	
0...10 V using differential inputs, needs 2 channels	4 / 2	
-10...+10 V using differential inputs, needs 2 channels	4 / 2	
Digital signals (digital input)	4 / 4	
Data when using the AI as digital input		
Input	time delay	8 ms typically, configurable from 0.1 up to 32 ms
	signal voltage	24 V DC
Outputs, single configurable as		
Possible configuration per AO	●	
-10...+10 V	●	
0...20 mA / 4...20 mA	●	
Output resistance (load) when used as current output	0...500 Ω	
Output loading capability when used as voltage output	±10 mA max.	
Potential isolation		
Per module	●	

AC500-XC

Technical data

Analog/digital mixed I/O extension module

Type	DA501-XC	DA502-XC
Process voltage UP		
Nominal voltage	24 V DC	
Current consumption on UP		
Min. (module alone)	0.070 A	
Max. (min. + loads)	0.070 A + load	
Reverse polarity protection	•	
Fuse for process voltage UP	10 A miniature fuse	
Approvals	See detailed page 284 or new.abb.com/plc	

AC500-XC

Technical data

DC541-CM-XC interrupt I/O and fast counter module

In the operating mode counter, the channels can be configured as follows:

Input, Output, 32-bit up/down counter (uses C0...C3) as a 32-bit counter without limit, 32-bit periodic counter as a 32-bit counter with a limit, limiter for a 32-bit counter (limit channel 0), 32-bit up counter (forward counter) with the frequencies 50 kHz, 5 kHz and 2.5 kHz, pulse-width modulation (PWM) with a resolution of 10 kHz, time and frequency measurement, frequency output.

Type		DC541-CM-XC
Number of channels per module		
Configurable channels DC (configurable as inputs or outputs)		8
Additional configuration of channels as		
Fast counter		Yes
Connection via CPU terminal base. Occupies one communication module slot		•
Digital inputs		
Input	signal voltage	24 V DC
	characteristic acc. to EN 61132-2	Type 1
0 signal		-3...+5 V DC
Undefined signal state		5...15 V DC
1 signal		5...30 V DC
Input time delay (0 -> 1 or 1 -> 0)		20 µs
		Clamp to clamp - 300 µs with interrupt task
Input current per channel		
At input voltage	24 V DC	5 mA typically
	5 V DC	> 1 mA
	15 V DC	> 5 mA
	30 V DC	< 8 mA
Digital outputs		
Transistor outputs 24 V DC, 0.5 A		•
Readback of output		•
Switching of 24 V load		•
Output voltage at signal state 1		Process voltage UP minus 0.8 V
Output current		
Nominal current per channel		500 mA at UP = 24 V
Maximum (total current of all channels)		4 A
Residual current at signal state 0		< 0.5 mA
Demagnetization when switching off inductive loads		by internal varistors
Potential isolation		
Per module		•
Voltage supply for the module		Internally via backplane bus

Interrupt I/O table

Configuration as	Configuration for channel no.					Max. no. of channels for this function	Remarks and notes regarding possible alternative combinations of the remaining channels (a and b)	
	Chan. 0	Chan. 1	Chan. 2	Chan. 3	Chan. 4-7			
Mode 1: Interrupt functionality								
Interrupt	Digital input	1	1	1	1	4	8	Each channel can be configured individually as interrupt input or output
	Digital output	1	1	1	1	4	8	
Mode 2: Counting functionality								
Digital I/Os	Digital input	1	1	1	1	4	8	Usual input
PWM (1)	Digital output	1	1	1	1	4	8	Usual output
	PWM, resolution 10 kHz	1	1	1	1	4	8	Outputs and pulsed signal with and adjustable on-off ratio

(1) Counter and fast counter data available on technical documentation.

AC500-XC

Technical data

AC500 Condition Monitoring CMS: FM502-CMS-XC

The FM502-CMS-XC function module offers precision and dynamic flexibility for customized solutions in condition monitoring, precise measurement or fast data logging applications. It has 16 fast, precise and synchronized analog inputs with 50k Samples/s (SPS), 24bit ADC resolution, completed with encoder inputs (incremental or absolute) with counter and additional DI and DC inputs/outputs on-board. It is easily configured using the Automation Builder software and the special libraries. Overall it has 12 different operation modes. One FM502 function module can be placed on the right side of PM592-ETH-XC CPU with a special function module terminal base TF5x1, to interface directly to the CPU. While long measurements can be flexibly configured, started and stopped, all inputs are available in the I/O Image of CPU for immediate use (measurement, protection, control, ...)

Type	FM502-CMS-XC	
Data storage		
Fast user data memory of FM502	128 MB (ca. 33 million Samples: e.g 40 s record length on 16 channels at 50k SPS or 5.8 h record length on 16 channels at 100 SPS)	
File Format delivered to PM592 flash	WAV (compact binary) per channel, all channels in one *.zip w. time stamp	
Analog inputs		
Number of channels	16 (synchronous sampled)	
Resolution	24 bit ADC, stored in DINT in WAV file (4byte per value)	
Accuracy at +25 °C	< +/- 0.1 %	
Accuracy over operating temperature and vibration	< +/- 0.5 %	
Sample rate / Bandwidth (High, 0 dB)	50k SPS / 20 kHz to 100 SPS / 40 Hz (digitally downsampled, selectable per channel)	
Indication of the input signal	One bicolor LED per channel for configuration, measurement status, error messages	
Input option:	IEPE (with Sensor supply current)	+ - 10 V
Bandwidth low (- 3 dB)	digital < 0.1 Hz	digital < 0.1 Hz or DC (selectable)
Pass band high (- 3 dB)	analog > 90 kHz, digital > 24.5 kHz	
Stop band high (> - 100 dB)	analog > 1 MHz, digital > 27.5 kHz	
Dynamic Range (SFDR)	> 100 dB	
SINAD (300 Hz/1 kHz sine, 50 k SPS) 0dB from full scale	< -90 dB	< - 95 dB
IEPE Current Source per channel	Typ. 4.2 mA (+/- 7 % over temperature)	(n.a.)
Resistance AI- to M (ground)	Typ ~ 270hm (PTC)	
Channel input impedance (AI+/AI-):		
< 1 kHz	> 1 MOhm	> 2 MOhm
5 kHz	> 100 kOhm	> 40 kOhm
10 kHz	> 60 kOhm	> 25 kOhm
20 kHz	> 40 kOhm	> 8 kOhm
Error detection	Short circuit, open wire	
Max. cable length, shielded (depending on sensor)	100 m	
Digital inputs/outputs		
	24 V DC, dedicated inputs/outputs can be used for specific counting functions.	
	All unused inputs/outputs can be used as normal input/output with standard specification.	
Channels and types	2 DI + 2 DC (configurable inputs/outputs); Type 1, LED indication	
Input options	Catch/Touch operation, counter value stored in separate variable on external event (rising or falling)	
	Set to preset counter register with predefined value	
	Set to reset counter register	
End value output	Output set when predefined value is reached	
Reference point initialization (RPI) input for relative encoder initialization	•	
Input current p. channel @ V DC		
24 V DC	Typically 5 mA	
5 V DC	> 1 mA	
15 V DC	> 5 mA	
30 V DC	< 8 mA	

AC500-XC

Technical data

AC500 Condition Monitoring CMS: FM502-CMS-XC

Type	FM502-CMS-XC	
Digital outputs		
Output voltage at signal state 1	(L+) – 0.8 V	
Output current		
Nominal current per channel	0.5 A at UP = 24 V	
Residual current at signal state 0	< 0.5 mA	
Demagnetization when switching off inductive loads	By internal varistors	
Switching frequency		
For inductive load	Max. 0.5 Hz	
For lamp load	Max. 11 Hz with max. 5 W	
Short-circuit / Overload proofness	•	
Overload indication (I > 0.7 A)	After approx. 100 ms	
Output current limiting	•	
Resistance against reverse feeding of 24 V signals	•	
Maximum cable length for connected process signals		
shielded	1000 m	
unshielded	600 m	
High-speed counter/encoder		
Integrated counters		
Counter characteristics	2 counters (24 V DC, 5 V DC, differential RS422: 5 V or 1 Vpp sinus input)	
Counter mode	one counter 32 bits or two counters 16 bits	
Relative position encoder	X1, X2, X3	
Absolute SSI encoder	•	
Time frequency meter	•	
Frequency input	up to 300 kHz	
Additional configuration of channels as		
Fast counter	Integrated 2 counter encoders	
high-speed inputs		
Number of channels, type per module	3 (A,B,Z), type 1	
Input type	24 V DC	5 V DC / Differential / Sinus 1 Vpp
Frequency	up to 300 kHz (input filter: 50,500, 5 k, 20 k Hz)	
Input frequency max. (frequency measurement only)	100 kHz (accuracy -0 %/+3 %)	
Max. cable length, shielded (depending on sensor)	300 m	100 m
Fast outputs		
SSI CLK output B	f. optical Interface (according SSI): Pin 1.3	RS-422 differential (according SSI) Pins 1.3, 1.4
Output delay (0->1 or 1->0)	Max. 0.35 µs	
Output current	≤ 10 mA	
Switching frequency (selectable)	200kHz, 500kHz and 1 MHz	
Short-circuit proof / overload proof	Yes	
Output current limitation	Yes, automatic reactivation after short-circuit/overload	
Resistance to feedback against 24V signals	Yes	
Resistance to feedback against reverse polarity	Yes	
Max. cable length, shielded (depending on sensor)	100 m	
Process voltage L+		
Nominal voltage	24 V DC	
Max. ripple	0,05	
Current consumption from L+ (FM502 and PM592, no communication module)	Max. 0.43 A + max. 0.5 A per output	
Inrush current from L+ (at power up, FM502 and PM592, no communication module)	1.2 A ² s	
Electrical isolation	Yes, (PM592 and FM502 to other I/O-Bus modules)	
Max. power dissipation within the FM502 module	6.5 W (outputs unloaded)	
5-V-encoder supply output		
Nominal voltage	5 V DC (+/- 5 %), 100 mA max.	

(1) High Temperatures:

Operation of FM502-XC version in the operating temperature range between +60 °C and +70 °C with following deratings:

No use of 24 V encoder mode

Analog inputs: maximum number of configured input channels limited to 75 % per group AI0..AI7 and AI8..AI15

AC500-XC

Technical data

AC500-XC communication modules

- Up to 4 communications modules can be used on an AC500-XC CPU, up to 6 on AC500-XC V3 CPU.
- No external power supply required.

Type	CM592-DP-XC	CM582-DP-XC	CM5640-2ETH-XC	CM597-ETH-XC	CM598-CN-XC
AC500-XC V3 support	●	●	● (3)	–	● (4)
Communication interfaces					
RJ45	–	–	● (x 2) no switch	● (x2) (2)	–
RS-232 / 485	–	–	–	–	–
Terminal blocks (1)	–	–	–	–	●
Sub-D socket	●	●	–	–	–
Protocols	PROFIBUS DP V0/V1 master	PROFIBUS DP V0/V1 slave	Ethernet (TCP/IP, UDP/IP, Modbus TCP)	Ethernet (TCP/IP, UDP/IP, Modbus TCP)	CANopen master
CPU interface	8 kB Dual-port memory	8 kB Dual-port memory		8 kB Dual-port memory	8 kB Dual-port memory
Transfer Rate	9.6 kbit/s to 12 Mbit/s	9.6 kbit/s to 12 Mbit/s	10 / 100 Mbit/s Port extender (5)	10/100 Mbit/s	10 kbit/s to 1 Mbit/s
Co-processor					
Additional features	Multi master functionality Max. Number of subscribers: - 126 (V0) - 32 (V1)	–	Online access, ICMP (Ping), DHCP, IP configuration protocol, UDP data exchange, Network variables Modbus TCP, OPC UA SNTP/NTP	Online Access, ICMP (Ping), DHCP, IP configuration protocol, UDP data exchange, Modbus TCP	CAN 2.0A CAN 2.0B CANopen

Type	CM588-CN-XC	CM579-PNIO-XC	CM589-PNIO-XC	CM589-PNIO-4-XC	CM5610-2RS-XC
AC500-XC V3 support	–	●	●	●	● (3)
Communication interfaces					
RJ45	–	● (x2) (2)	● (x2) (2)	● (x2) (2)	–
RS-232 / 485	–	–	–	–	● (x 2)
Terminal blocks (1)	●	–	–	–	● (x 2)
Sub-D socket	–	–	–	–	–
Protocols	CANopen slave	PROFINET IO controller	PROFINET IO device	PROFINET IO 4 x device	Serial COM ASCII, Modbus RTU
CPU interface	8 kB Dual-port memory	8 kB Dual-port memory	8 kB Dual-port memory	8 kB Dual-port memory	
Transfer Rate	10 kbit/s to 1 Mbit/s	10/100 Mbit/s	10/100 Mbit/s	10/100 Mbit/s	9.6 kbit/s up to 112 kbit/s Port extender
Co-processor					
Additional features	NMT slave, PDO, SDO server, Heartbeat, Nodeguard	RTC - Real-Time Cyclic Protocol, Class 1 RTA - Real-Time Acyclic Protocol DCP Discovery and Configuration Protocol CL-RPC - Connectionless Remote Procedure Call	RTC - Real-Time Cyclic Protocol, Class 1 RTA - Real-Time Acyclic Protocol DCP Discovery and Configuration Protocol LLDP - Link Layer Discovery Protocol	RTC - Real-Time Cyclic Protocol, Class 1 RTA - Real-Time Acyclic Protocol DCP Discovery and Configuration Protocol LLDP - Link Layer Discovery Protocol	Acts as a serial interface extender from the CPU used. The CPU handles the protocol like ASCII or Modbus RTU on both interfaces

(1) Plug-in terminal block included.

(2) 10/100 Mbit/s, full/half duplex with auto-sensing, 2-port switch integrated.

(3) In preparation

(4) Only with CAN 2A/2B today

(5) The CM5640-2ETH communication module is a port extender providing 2 additional "onboard Ethernet" interfaces to the connected CPU which manages all the communication. Some of the onboard Ethernet features are available, the Ethernet limitations from the CPU will then apply in total for all the connected interfaces. The CM5640-2ETH doesn't extend the limits which remain those of the connected CPU, e.g. no increase of Ethernet sockets or number of OPC UA tags.

AC500-XC

Technical data

Communication interface modules

For all modules: max cable length for connected process signals is 1000 m for shielded cable and 600 m for unshielded ones. For all Input modules, the signal resolution for channel configuration is: -10...+10 V: 13 bits including sign; 0...10 V, 0...20 mA, 4...20 mA: 12 bits. Temperature: 0.1 °C.

Type	DC551-CS31-XC	CI590-CS31-HA-XC (1)	CI592-CS31-XC
Communication Interface			
Protocol	Proprietary CS31 bus protocol on RS485 interface		
ID configuration	Per rotary switches on front face from 00d to 99d		
Field bus connection on TUs	CS31 field bus, via terminal / redundant for CI590-CS31-HA-XC on TU552-CS31-XC		
Number of Channels per Module			
Digital	inputs	8	8
	outputs	-	-
Analog	inputs	-	4
	outputs	-	2
Digital configurable channels DC (configurable as inputs or outputs)	16	16	8
Additional configuration of channels as			
Fast counter	Configuration of max. 2 channels per module		
Occupies max. 1 DO or DC when used as counter	●	●	●
Connection			
Via terminal base TU5xx	●	●	●
Local I/O extension			
Max. number of extension modules	max. 7 x S500 extension modules, up to 31 stations with up to 120 DI/120 DOs or up to 32 AIs/ 32AOs per station		
Digital inputs			
Input	signal voltage	24 V DC	
	characteristic acc. to EN 61132-2	Type 1	
0 signal	-3...+5 V DC		
Undefined signal state	5...15 V DC		
1 signal	15...30 V DC		
Residual ripple, range for	0 signal	-3...+5 V DC	
	1 signal	15...30 V DC	
Input time delay (0 -> 1 or 1 -> 0)	8 ms typically, configurable from 0.1 up to 32 ms		
Digital outputs			
Transistor outputs 24 V DC, 0.5 A	●		
Readback of output	●		
Outputs, supplied via process voltage UP	●		
Switching of 24 V load	●		
Output voltage at signal state 1	Process voltage UP - 0.8 V		
Output current			
Nominal current per channel	500 mA at UP = 24 V DC		
Maximum (total current of all channels)	8 A	8 A	4 A
Residual current at signal state 0	< 0.5 mA		
Demagnetization when switching off inductive loads	By internal varistors		
Analog inputs AI			
Signal configuration per AI	-	●	
0...10 V / -10...+10 V	-	4 / 4	
0...20 mA / 4...20 mA	-	4 / 4	
RTD using 2/3 wire needs 1/2 channel(s)	-	4 / 2	
0...10 V using differential inputs, needs 2 channels	-	4 / 2	
-10...+10 V using differential inputs, needs 2 channels	-	4 / 2	
Digital signals (digital input)	-	4 / 4	

(1) Dedicated to High Availability. Not compatible with S500-eCo I/O modules.

AC500-XC

Technical data

Communication interface modules

Type		DC551-CS31-XC	CI590-CS31-HA-XC (1)	CI592-CS31-XC
Data when using the AI as digital input				
Input	time delay	–		8 ms typically, configurable from 0.1 up to 32 ms
	signal voltage	–		24 V DC
Outputs, single configurable as				
Possible configuration per AO		–		●
-10...+10 V		–		●
0...20 mA / 4...20 mA		–		●
Output	resistance (load) when used as current output	–		0...500 Ω
	loading capability when used as voltage output	–		±10 mA max.
Potential isolation				
Per module		●	●	●
Between fieldbus interface against the rest of the module		●	●	●
Voltage supply for the module		By external 24 V DC voltage via terminal UP		
Process voltage UP				
Nominal voltage		24 V DC		
Current consumption on UP				
Min. (module alone)		0.100 A	0.100 A	0.070 A
Max. (min. + loads)		0.100 A + load	0.100 A + load	0.070 A + load
Reverse polarity protection		●		
Fuse for process voltage UP		10 A miniature fuse		
Approvals		See detailed page 284 or new.abb.com/plc		

(1) Dedicated to High Availability. Not compatible with S500-eCo I/O modules.

AC500-XC

Technical data

PROFIBUS-DP modules

Type	CI541-DP-XC	CI542-DP-XC	
Communication Interface			
Protocol	PROFIBUS DP (DP-V0 and DP-V1 slave)		
ID configuration	Per rotary switches on front face from 00h to FFh		
Field bus connection on terminal units	Sub-D 9 poles on TU510-XC or TU518-XC with baud rate up to 1Mbaud		
Number of Channels per Module			
Digital	inputs	8	8
	outputs	8	8
Analog	inputs	4	–
	outputs	2	–
Digital configurable channels DC (configurable as inputs or outputs)	–	–	8
Additional configuration of channels as			
Fast counter (onboard I/O)	Configuration of max. 2 DI channels per module		
Occupies max 1 DO or DC when used as counter	•	•	
Connection			
Local I/O extension	•		
Max. number of extension modules	max. 10 x S500 extension modules, fast counter from digital I/O modules can be also used		
Via terminal base TU5xx	•	•	
Digital inputs			
Input	signal voltage	24 V DC	
	characteristic acc. to EN 61132-2	Type 1	
0 signal	–3...+5 V DC		
Undefined signal state	5...15 V DC		
1 signal	15...30 V DC		
Residual ripple, range for	0 signal	–3...+5 V DC	
	1 signal	15...30 V DC	
Input time delay (0 -> 1 or 1 -> 0)	8 ms typically, configurable from 0.1 up to 32 ms		
Digital outputs			
Transistor outputs 24 V DC, 0.5 A	•		
Readback of output	–	• (on DC outputs)	
Outputs, supplied via process voltage UP	•		
Switching of 24 V load	•		
Output voltage at signal state 1	Process voltage UP - 0.8 V		
Output current			
Nominal current per channel	500 mA at UP = 24 V DC		
Maximum (total current of all channels)	8 A		
Residual current at signal state 0	< 0.5 mA		
Demagnetization when switching off inductive loads	By internal varistors		
Analog Inputs AI			
	Max. number per module and with regard to the configuration: AIs / Measuring points		
Signal configuration per AI	4	–	
0...10 V / -10...+10 V	4 / 4	–	
0...20 mA / 4...20 mA	4 / 4	–	
RTD using 2/3 wire needs 1/2 channel(s)	4 / 2	–	
0...10 V using differential inputs, needs 2 channels	4 / 2	–	
-10...+10 V using differential inputs, needs 2 channels	4 / 2	–	
Digital signals (digital input)	4 / 4	–	
Data when using the AI as digital input			
Input	time delay	8 ms typically, configurable from 0.1 up to 32 ms	–
	signal voltage	24 V DC	–

AC500-XC

Technical data

PROFIBUS-DP modules

Type	CI541-DP-XC	CI542-DP-XC
Outputs, single configurable as		
Possible configuration per AO	•	–
-10...+10V	•	–
0...20 mA / 4...20 mA	•	–
Output resistance (load) when used as current output	0...500 Ω	–
loading capability when used as voltage output	±10 mA max.	–
Potential isolation		
Per module	•	•
Between fieldbus interface against the rest of the module	•	•
Between the channels		
input	–	–
output	–	–
Voltage supply for the module	By external 24 V DC voltage via terminal UP	
Process voltage UP		
Nominal voltage	24 V DC	
Current consumption on UP		
Min. (module alone)	0.260 A	
Max. (min. + loads)	0.260 A + load	
Reverse polarity protection	•	
Fuse for process voltage UP	10 A miniature fuse	
Approvals	See detailed page 284 or new.abb.com/plc	

AC500-XC

Technical data

CANopen modules

Type	CI581-CN-XC	CI582-CN-XC
Communication interface		
Protocol	CANopen slave, DS401 profile selectable using rotary switches	
ID configuration	Per rotary switches on front face for CANopen ID node from 00h to 7Fh and 80h to FFh for CANopen DS401 profile	
Field bus connection on terminal units	Terminal blocks on TU518-XC	
Number of channels per module		
Digital	inputs	8
	outputs	8
Analog	inputs	4
	outputs	2
Digital configurable channels DC (configurable as inputs or outputs)	–	8
Additional configuration of channels as		
Fast counter (onboard I/O)	Configuration of max. 2 DI channels per module	
Occupies max. 1 DO or DC when used as counter	●	●
Connection		
Local I/O extension	●	
Max. number of extension modules	max. 10 x S500-XC extension modules	
Via terminal unit TU5xx	●	●
Digital inputs		
Input	signal voltage	24 V DC
	characteristic acc. to EN 61132-2	Type 1
0 signal		-3...+5 V DC
Undefined signal state		5...15 V DC
1 signal		15...30 V DC
Residual ripple, range for	0 signal	-3...+5 V DC
	1 signal	15...30 V DC
Input time delay (0 -> 1 or 1 -> 0)	8 ms typically, configurable from 0.1 up to 32 ms	
Digital outputs		
Transistor outputs 24 V DC, 0.5 A	●	
Readback of output	–	● (on DC outputs)
Outputs, supplied via process voltage UP	●	
Switching of 24 V load	●	
Output voltage at signal state 1	Process voltage UP - 0.8 V	
Output current		
Nominal current per channel	500 mA at UP = 24 V DC	
Maximum (total current of all channels)	8 A	
Residual current at signal state 0	< 0.5 mA	
Demagnetization when switching off inductive loads	By internal varistors	
Analog Inputs AI		
Max. number per module and with regard to the configuration: AIs / Measuring points		
Signal configuration per AI	4	–
0...10 V / -10...+10 V	4 / 4	–
0...20 mA / 4...20 mA	4 / 4	–
RTD using 2/3 wire needs 1/2 channel(s)	4 / 2	–
0...10 V using differential inputs, needs 2 channels	4 / 2	–
-10...+10 V using differential inputs, needs 2 channels	4 / 2	–
Digital signals (digital input)	4 / 4	–
Data when using the AI as digital input		
Input	time delay	8 ms typically, configurable from 0.1 up to 32 ms
	signal voltage	24 V DC

AC500-XC

Technical data

CANopen modules

Type	CI581-CN-XC	CI582-CN-XC
Outputs, single configurable as		
Possible configuration per AO	●	–
-10...+10 V	●	–
0...20 mA / 4...20 mA	●	–
Output	resistance (load) when used as current output	0...500 Ω
	loading capability when used as voltage output	±10 mA max.
Potential isolation		
Per module	●	●
Between fieldbus interface against the rest of the module	●	●
Between the channels	input	–
	output	–
Voltage supply for the module	By external 24 V DC voltage via terminal UP	
Process voltage UP		
Nominal voltage	24 V DC	
Current consumption on UP		
Min. (module alone)	0.260 A	
Max. (min. + loads)	0.260 A + load	
Reverse polarity protection	●	
Fuse for process voltage UP	10 A miniature fuse	
Approvals	See detailed page 284 or new.abb.com/plc	

AC500-XC

Technical data

PROFINET IO RT device modules

Type	CI501-PNIO-XC	CI502-PNIO-XC	CI504-PNIO-XC	CI506-PNIO-XC
Communication interface				
Ethernet Interface				
Main protocol	PROFINET IO RT device			
ID Device configuration	By rotary switch on the front side, from 00h to FFh			
Ethernet connection on terminal units	2 x RJ45 with switch functionality for simple daisy chain on TU508-ETH-XC or TU520-ETH-XC			
Gateway Interface				
Gateway to	-	-	3 x RS232/RS422/ RS485 ASCII serial interfaces	CAN / CANopen Master + 2 x RS232/RS422/ RS485 ASCII serial interfaces
Fieldbus Protocol used				
CAN physical interface	-	-	-	CAN 2A/2B Master - CANopen Master (1)
Baudrate	-	-	-	Baudrate up to 1 Mbit/s, Support for up to 126 CANopen Slaves
Serial interface				
Protocol used	-	-	3 x RS232 / RS422 or RS485	2 x RS232 / RS422 or RS485
Baudrate	-	-	Configurable from 300 bit/s to 115200 bit/s	
Fieldbus or serial connection on TUs	-	-	3 x pluggable terminal blocks with spring on TU520-ETH	
Number of channels per module				
Digital	inputs	8	8	-
	outputs	8	8	-
Analog	inputs	4	-	-
	outputs	2	-	-
Digital configurable channels DC (configurable as inputs or outputs)		-	8	-
Additional configuration of channels as				
Connection via terminal unit TU5xx		-	-	●
Fast counter (onboard I/O)		Configuration of max. 2 DI channels per module		-
Occupies max. 1 DO or DC when used as counter		●	-	-
Connection				
Local I/O extension		●	-	●
Max. number of extension modules		max. 10 x S500-XC extension modules. Fast counter from digital I/O modules can be also used.		Valid for CI501-XC, 502-XC, 504-XC and 506-XC. All modules can have extension up to 10 modules
Digital inputs				
Input	signal voltage	24 V DC		
	characteristic acc. to EN 61132-2	Type 1		
0 signal	-3...+5 V DC			
Undefined signal state	5...15 V DC			
1 signal	15...30 V DC			
Residual ripple, range for	0 signal	-3...+5 V DC		
	1 signal	15...30 V DC		
Input time delay (0 -> 1 or 1 -> 0)		8 ms typically, configurable from 0.1 up to 32 ms		
Digital outputs				
Transistor outputs 24 V DC, 0.5 A		●	-	-
Readback of output		-	● (on DC outputs)	-
Outputs, supplied via process voltage UP		●	-	-
Switching of 24 V load		●	-	-
Output voltage at signal state 1		Process voltage UP - 0.8 V		

(1) Not simultaneously.

AC500-XC

Technical data

PROFINET IO RT device modules

Type	CI501-PNIO-XC	CI502-PNIO-XC	CI504-PNIO-XC	CI506-PNIO-XC
Output current				
Nominal current per channel	500 mA at UP = 24 V DC		–	–
Maximum (total current of all channels)	8 A		–	–
Residual current at signal state 0	< 0.5 mA		–	–
Demagnetization when switching off inductive loads	By internal varistors		–	–
Analog inputs AI				
	Max. number per module and with regard to the configuration: AIs / Measuring points			
Signal configuration per AI	4	–	–	–
0...10 V / -10... +10 V	4 / 4	–	–	–
0...20 mA / 4...20 mA	4 / 4	–	–	–
RTD using 2/3 wire needs 1/2 channel(s)	4 / 2	–	–	–
0...10 V using differential inputs, needs 2 channels	4 / 2	–	–	–
-10...+10 V using differential inputs, needs 2 channels	4 / 2	–	–	–
Digital signals (digital input)	4 / 4	–	–	–
Data when using the AI as digital input				
Input	time delay	8 ms typically, configurable from 0.1 up to 32 ms	–	–
	signal voltage	24 V DC	–	–
Outputs, single configurable as				
Possible configuration per AO	●	–	–	–
-10...+10 V	●	–	–	–
0...20 mA / 4...20 mA	●	–	–	–
Output	resistance (load) when used as current output	0...500 Ω	–	–
	loading capability when used as voltage output	±10 mA max.	–	–
Potential isolation				
Per module	●	●	●	●
Between Ethernet interface against the rest of the module	●	●	●	●
Voltage supply for the module	By external 24 V DC voltage via terminal UP			
Process voltage UP				
Nominal voltage	24 V DC			
Current consumption on UP	min. (module alone)	0.260 A		0.150 A
	max. (min. + loads)	0.260 A + load		0.150 A + load
Reverse polarity protection	●			
Fuse for process voltage UP	10 A miniature fuse			
Approvals	See detailed page 284 or new.abb.com/plc			

(1) Not simultaneously.

AC500-XC

Technical data

Modbus TCP modules

Type	CI521-MODTCP-XC	CI522-MODTCP-XC	
Communication interface			
Ethernet Interface			
Main protocol	Modbus TCP		
ID Device configuration	By rotary switch on the front side, from 00h to FFh		
Ethernet connection on terminal units	2 x RJ45 with switch functionality for simple daisy chain on TU508-ETH-XC or TU520-ETH-XC		
Number of channels per module			
Digital	inputs	8	8
	outputs	8	8
Analog	inputs	4	–
	outputs	2	–
Digital configurable channels DC (configurable as inputs or outputs)		–	8
Additional configuration of channels as			
Connection via terminal unit TU5xx	–	–	
Fast counter (onboard I/O)	Configuration of max. 2 DI channels per module		
Occupies max. 1 DO or DC when used as counter	●		
Connection			
Local I/O extension	●		
Max. number of extension modules	max. 10 x S500-XC extension modules. Fast counter from digital I/O modules can be also used.		
Digital inputs			
Input	signal voltage	24 V DC	
	characteristic acc. to EN 61132-2	Type 1	
0 signal	–3...+5 V DC		
Undefined signal state	5...15 V DC		
1 signal	15...30 V DC		
Residual ripple, range for	0 signal	–3...+5 V DC	
	1 signal	15...30 V DC	
Input time delay (0 -> 1 or 1 -> 0)	8 ms typically, configurable from 0.1 up to 32 ms		
Digital outputs			
Transistor outputs 24 V DC, 0.5 A	●		
Readback of output	–	● (on DC outputs)	
Outputs, supplied via process voltage UP	●		
Switching of 24 V load	●		
Output voltage at signal state 1	Process voltage UP - 0.8 V		
Output current			
Nominal current per channel	500 mA at UP = 24 V DC		
Maximum (total current of all channels)	8 A		
Residual current at signal state 0	< 0.5 mA		
Demagnetization when switching off inductive loads	By internal varistors		
Analog inputs AI			
Max. number per module and with regard to the configuration: AIs / Measuring points			
Signal configuration per AI	4	–	
0...10 V / -10... +10 V	4 / 4	–	
0...20 mA / 4...20 mA	4 / 4	–	
RTD using 2/3 wire needs 1/2 channel(s)	4 / 2	–	
0...10 V using differential inputs, needs 2 channels	4 / 2	–	
-10...+10 V using differential inputs, needs 2 channels	4 / 2	–	
Digital signals (digital input)	4 / 4	–	

(1) Not simultaneously.

AC500-XC

Technical data

Modbus TCP modules

Type		CI521-MODTCP-XC	CI522-MODTCP-XC
Data when using the AI as digital input			
Input	time delay	8 ms typically, configurable from 0.1 up to 32 ms	–
	signal voltage	24 V DC	–
Outputs, single configurable as			
Possible configuration per AO		●	–
-10...+10 V		●	–
0...20 mA / 4...20 mA		●	–
Output	resistance (load) when used as current output	0...500 Ω	–
	loading capability when used as voltage output	±10 mA max.	–
Potential isolation			
Per module		●	●
Between Ethernet interface against the rest of the module		●	●
Voltage supply for the module		By external 24 V DC voltage via terminal UP	
Process voltage UP			
Nominal voltage		24 V DC	
Current consumption on UP			
min. (module alone)		0.260 A	
max. (min. + loads)		0.260 A + load	
Reverse polarity protection		●	
Fuse for process voltage UP		10 A miniature fuse	
Approvals		See detailed page 284 or new.abb.com/plc	

(1) Not simultaneously.

AC500-XC

Technical data

CS31 functionality

	AC500-XC CPU with integrated CS31 interface	S500 I/O with communication interface DC551-CS31-XC CI590-CS31-HA-XC CI592-CS31-XC
Master	Yes, at COM1	-
Slave	No	Yes / Redundant for CI590-CS31-HA-XC
Protocols supported	ABB CS31 protocol	
Diagnosis		
Error indication	On LCD display of the CPU	Via module LEDs
Online diagnosis	Yes	
Error code	Errors are recorded in the diagnosis system of the CPU	
Associated function blocks	Yes	
Physical layer		
Connection	RS485 / 2 x RS485 for CI590-CS31-HA-XC for redundancy	Screw-type or spring-type terminals
Baud rate	187.5 kbit/s	
Distance	AC500-XC: up to 500 m; up to 2000 m using a repeater	
Max. number of modules on fieldbus	31 modules max. Please note: The CS31 bus interface occupies one or two module addresses (if counters are configured onboard or if the module is a mixed digital analog module). Depending on the configuration, or if the module contains also mixed digital analog I/O, connected extension modules can occupy further module addresses.	
Configuration		
Station address configuration	Using configuration tool (included in Automation Builder software suite)	Using rotary switches (99 max.)

Digital I/O modules, "Fast Counter" operating modes. Not applicable for DC541-XC (1)

Operating mode, configured in the user program of the AC500-XC	Occupied inputs DI or DC	Occupied outputs DO or DC	Maximum counting frequency kHz
0 No counter	0	0	-
1 One count-up counter with "end value reached" indication	1	1	50
2 One count-up counter with "enable" input and "end value reached" indication	2	1	50
3 Two up/down counters	2	0	50
4 Two up/down counters with 1 counting input inverted	2	0	50
5 One up/down counter with "dynamic set" input	2	0	50
6 One up/down counter with "dynamic set" input	2	0	50
7 One up/down counter with directional discriminator For synchro transmitters using two counting pulses with an offset of 90° (track A and B)	2	0	50
8 -	0	0	-
9 One up/down counter with directional discriminator and double evaluation For synchro transmitters using two counting pulses with an offset of 90° towards each other (track A and B)	2	0	30
10 One up/down counter with directional discriminator and fourfold evaluation For synchro transmitters using two counting pulses with an offset of 90° towards each other (track A and B)	2	0	15

(1) See technical documentation for details.

AC500-XC

System data

Environmental Conditions

Process and supply voltages

24 V DC	Voltage	24 V (-15 %, +20 %)
	Protection against reverse polarity	yes
Allowed interruptions of power supply	DC supply	Interruption < 10 ms, time between 2 interruptions > 1 s, PS2
	AC supply	Interruption < 0.5 periods, time between 2 interruptions > 1 s

Important: Exceeding the maximum process and supply voltages could lead to unrecoverable damage of the system. The system could be destroyed. For the supply of the modules, power supply units in accordance with PELV or SELV specifications must be used. The creepage distances and clearances meet the requirements of the overvoltage category II, pollution degree 2.

Assembly position

Horizontal	•
Vertical	• (1)

(1) not in salt mist environment

Temperature

Operating	-40 °C ... +70 °C	
	-40 °C ... 0 °C	Due to the LCD technology, the display might not be readable
	-40 °C...+40 °C	vertical mounting of modules possible, output load limited to 50 % per group with the following deratings:
	+60 °C ...+70 °C	System is limited to max. 2 Communication Modules per Terminal Base Applications certified for cULus up to 60 °C Digital inputs: maximum number of simultaneously switched on input channels limited to 75 % per group (e.g. 8 channels => 6 channels) Digital outputs: output current maximum value (all channels together) limited to 75 % per group (e.g. 8 A => 6 A) Analog outputs only if configured as voltage output: maximum total output current per group is limited to 75 % (e.g. 40 mA => 30 mA) Analog outputs only if configured as current output: maximum number of simultaneously used output channels limited to 75 % per group (e.g. 4 channels => 3 channels)
Storage / Transport	-40 °C ... +85 °C	

Humidity

Operating / Storage	100 % r. H. with condensation
---------------------	-------------------------------

Air pressure

Operating	-1000 m 4000 m (1080 hPa ... 620 hPa)
-----------	--

Storage	>2000 m (<795 hPa): max. operating temperature must be reduced by 10K per 1000 m (e.g. 70 °C to 60 °C)
---------	--

Immunity to corrosive gases

Operating	Yes, in accordance with: ANSI/ISA-71.04: Containment group A, G3 - Harsh / GX - Severe IEC 60068-2-60: Method 4 IEC 60721-3-3: Class 3C2 / 3C3 Gases and concentrations: Hydrogen sulfide (H ₂ S): (100 ± 5) ppb Nitrogen dioxide (NO ₂): (1250 ± 20) ppb Chlorine (Cl ₂): (100 ± 5) ppb Sulfur dioxide (SO ₂): (300 ± 20) ppb
-----------	--

Immunity to salt mist

Operating	Yes, horizontal mounting only, in accordance with IEC 60068-2-52 severity level: 1 NOTICE! Risk of corrosion! Unused connectors and slots may corrode, if using XC devices in salt mist environments. Protect unused connectors and slots with TA535 protective caps for XC devices.
-----------	--

AC500-XC

System data

Environmental Conditions

Electromagnetic Compatibility

Radiated emission (radio disturbances)	Yes, in accordance with CISPR 16-2-3
Conducted emission (radio disturbances)	Yes, in accordance with CISPR 16-2-1, CISPR 16-1-2
Electrostatic discharge (ESD)	Yes, in accordance with IEC 61000-4-2, zone B, criterion B Electrostatic voltage in case of air discharge: 8 kV Electrostatic voltage in case of contact discharge: 6 kV
Fast transient interference voltages (burst)	Yes, in accordance with IEC 61000-4-4, zone B, criterion B Supply voltage units (DC): 4 kV Digital inputs/outputs (24 V DC): 2 kV Analog inputs/outputs: 2 kV Communication lines shielded: 2 kV I/O supply (DC-out): 2 kV
High energy transient interference voltages (surge)	Yes, in accordance with IEC 61000-4-5, zone B, criterion B Supply voltage units (DC): 1 kV CM* / 0.5 kV DM* Supply voltage units (AC): 2 kV CM* / 1 kV DM* Digital inputs/outputs (24 V DC): 1 kV CM* / 0.5 kV DM* Digital inputs/outputs (120...240 V AC): 2 kV CM* / 1 kV DM* Analog inputs/outputs: 1 kV CM* / 0.5 kV DM* Communication lines shielded: 1 kV CM* I/O supply (DC-out): 0,5 kV CM* / 0.5 kV DM* * CM = Common Mode, * DM = Differential Mode
Influence of radiated disturbances	Yes, in accordance with IEC 61000-4-3, zone B, criterion A Test field strength: 10 V/m
Influence of line-conducted interferences	Yes, in accordance with IEC 61000-4-6, zone B, criterion A Test voltage: 10 V
Influence of power frequency magnetic fields	Yes, in accordance with IEC 61000-4-8, zone B, criterion A 30 A/m 50 Hz 30 A/m 60 Hz

WARNING!

Risk of malfunctions and damages to persons!

Unused slots for communication modules are not protected against contact discharge. Dust and dirt may cause contact problems and malfunctions.

Unused slots for communication modules must be covered with dummy communication modules ("TA524 - Dummy Communication Module").

I/O-bus connectors must not be touched during operation.

In order to prevent malfunctions, it is recommended that the operating personnel discharge themselves prior to touching communication connectors or perform other suitable measures to reduce effects of electrostatic discharges.

Environmental Tests

Storage	IEC 60068-2-1 Test Ab: cold withstand test -40 °C / 16 h IEC 60068-2-2 Test Bb: dry heat withstand test +85 °C / 16 h
Humidity	IEC 60068-2-30 Test Db: cyclic (12 h / 12 h) damp-heat test 55 °C, 93 % r. H. / 25 °C, 95 % r. H., 6 cycles
Vibrations	IEC 60068-2-78, Stationary Vibration Test: 40 °C, 93 % r. H., 240 h
Shock resistance	IEC 61131-2 / IEC 60068-2-6: 5 Hz ... 500 Hz, 2 g (with Memory Card inserted) IEC 60068-2-64: 5 Hz ... 500 Hz, 4 g rms IEC 60068-2-27: all 3 axes 15 g, 11 ms, half-sinusoidal

Mechanical Data

Wiring method	Spring terminals
Degree of protection	IP 20
Assembly on DIN rail	DIN rail type In accordance with IEC 60715 35 mm, depth 7.5 mm or 15 mm
Assembly with screws	Screw diameter 4 mm
	Fastening torque 1.2 Nm

AC500-S

Functional safety PLC

243	Key features
244	Ordering data AC500-S
245	Ordering data AC500-S-XC
246–248	Technical data
249–252	System data

SM560-S

ABB

WR
IAG
RUN
ERR
ERR

SYS
BATT
I/O-Bus

run

ETH
FBP
COM
COM

PWR

RUN

ERR



ADDR x10H

0 1 2 3 4 5 6 7 8 9
F E D C B A

ADDR x01H

0 1 2 3 4 5 6 7 8 9
F E D C B A



WARNING
Use of incorrect battery may cause fire or explosion.

RUN

DIAG

VAL

CFG

ESC

↑

OK

↑

MC 502

UP 24VDC 10W

AC500-S

Key features



Easy integration: Simple extension of ABB PLC with safety functions. One common engineering and diagnostic system for safety and standard CPUs. eXtreme Conditions (-XC) version is available.

Easy implementation of flexible configuration concept (one safety program for various machine types). Safety CPU can be configured to work even if standard CPU is in STOP mode.

ABB Ability™ Automation Builder productivity suite providing integrated support of ST, Ladder (LD) and Function Block Diagram (FBD) programming with a common look and feel. Trigonometric functions are supported for easy implementation of complex calculation tasks.

Both simple and complex safety functions can be easily implemented:

- Safely limited acceleration
- Safely limited deceleration
- Safely limited force
- Safely limited orientation
- Safely limited position
- Safely limited speed
- Safely limited torque.

PROFINET/PROFIsafe interface for decentralized safety I/Os, safe position and speed monitoring as well as triggering of safety drive functions. Configurable real-time exchange of high volume process and safety data between multiple PLC controllers using PROFINET/PROFIsafe.

AC500-S

Ordering data

Safety CPU

Description	User program memory		Type	Order code	Weight (1 pce) kg
	MB				
Safety CPU module	1		SM560-S	1SAP280000R0001	0.087
Safety CPU module with F-Device functionality for 1 PROFIsafe network	1.3		SM560-S-FD-1	1SAP286000R0001	0.087
Safety CPU module with F-Device functionality for 4 PROFIsafe networks	1.3		SM560-S-FD-4	1SAP286100R0001	0.087

S500 Safety I/O

Description	Input signal		Output signal SIL3	Type	Order code	Weight (1 pce) kg
	SIL2	SIL3				
Safety digital input module	16	8	-	DI581-S	1SAP284000R0001	0.122
Safety digital input / output module	8	4	8	DX581-S	1SAP284100R0001	0.130
Safety analog input module	4	2	-	AI581-S	1SAP282000R0001	0.125

S500 Safety terminal unit

Description	Type	Order code	Weight (1 pce) kg
Spring terminal unit for safety I/O modules	TU582-S	1SAP281200R0001	0.162

Software

AC500-S safety PLC programming license needs to be purchased as an additional feature of ABB Ability™ Automation Builder. For details, see ordering data of Automation Builder.



SM560-S
SM560-S-FD-1
SM560-S-FD-4



DI581-S
DX581-S
AI581-S



TU582-S

Accessories for AC500-S

For	Description	Type	Order code	Weight (1 pce) kg
AC500-S safety PLC training case (1)	SM560-S, DI581-S, DX581-S, AI581-S, TU582-S with PM573-ETH and PNIO	TA514-SAFETY	1SAP182900R0001	10

(1) Any standard AC500 CPU (V2 or V3) can be used instead of PM573-ETH in TA514-SAFETY. They have to be ordered separately. In case of AC500 V3 CPUs, TB5620-2ETH shall be ordered as well.



AC500-S training case

AC500-S-XC

Ordering data

Safety XC CPU

Description	User program memory		Type	Order code	Weight (1 pce) kg
	MB				
Safety CPU module	1		SM560-S-XC	1SAP380000R0001	0.089
Safety CPU module with F-Device functionality for 1 PROFI-safe network	1.3		SM560-S-FD-1-XC	1SAP386000R0001	0.089
Safety CPU module with F-Device functionality for 4 PROFI-safe networks	1.3		SM560-S-FD-4-XC	1SAP386100R0001	0.089

S500-XC Safety I/O

Description	Input signal		Output signal SIL3	Type	Order code	Weight (1 pce) kg
	SIL2	SIL3				
Safety digital input module	16	8	-	DI581-S-XC	1SAP484000R0001	0.123
Safety digital input / output module	8	4	8	DX581-S-XC	1SAP484100R0001	0.131
Safety analog input module	4	2	-	AI581-S-XC	1SAP482000R0001	0.126

S500-XC Safety terminal unit

Description	Type	Order code	Weight (1 pce) kg
Spring terminal unit for safety I/O modules	TU582-S-XC	1SAP481200R0001	0.164



SM560-S-XC
SM560-S-FD-1-XC
SM560-S-FD-4-XC



DI581-S-XC
DX581-S-XC
AI581-S-XC



TU582-S-XC

AC500-S and AC500-S-XC

Technical data

Safety CPUs

Type		SM560-S / SM560-S-XC	SM560-S-FD-1 / SM560-S-FD-4 / SM560-S-FD-1-XC / SM560-S-FD-4-XC
Performance level		PL e (ISO 13849-1)	
Safety	integrity level	SIL3 (IEC 61508:2010, IEC 62061, IEC 61511)	
	protocol	PROFIsafe V2 F-Host via PROFINET	PROFIsafe V2 F-Host and F-Device (for 1 or 4 PROFIsafe networks, respectively) via PROFINET
Program memory flash EPROM and RAM		1 MB	1.3 MB
Integrated data memory		1 MB thereof 120 kB saved	1.0 MB thereof 120 kB saved
Cycle time for 1 instruction			
Binary		0.05 µs	
Word		0.06 µs	
Floating point		0.5 µs	
Max. number of centralized inputs/outputs			
Max. nb. of safety extension modules on I/O bus		10	
Digital	inputs	160 (SIL2) / 80 (SIL3)	
	outputs	80 (SIL3)	
Analog	inputs	40 (SIL2) / 20 (SIL3)	
Max. number of decentralized inputs/outputs		On PROFINET: up to 128 stations with up to 10 safety extension modules	
Program execution			
Cyclical		•	
User program protection by password		•	
Interfaces			
Ethernet		Via AC500 CPU or communication module	
COM		Via AC500 CPU	
Programming		Via AC500 CPU	
Approvals		CE, cUL, UL, C-Tick and other on request	

AC500-S and AC500-S-XC

Technical data

S500 and S500-XC Safety I/O

Type	DI581-S / DI581-S-XC	DX581-S / DX581-S-XC	AI581-S / AI581-S-XC
Performance Level	PL e (ISO 13849-1)		
Safety Integrity Level	SIL3 (IEC 61508:2010, IEC 62061, IEC 61511)		
Safety protocol	PROFIsafe V2 via PROFINET		
Digital inputs			
Number of channels per module	16 (SIL2) / 8 (SIL3)	8 (SIL2) / 4 (SIL3)	-
Input signal voltage	24 V DC	24 V DC	-
Frequency range	65 Hz	65 Hz	-
Input characteristic acc. to EN61131-2	Type 1	Type 1	-
0 signal	-3...+5 V DC	-3...+5 V DC	-
Undefined signal state	5...15 V DC	5...15 V DC	-
1 signal	15...30 V DC	15...30 V DC	-
Input time delay (0 -> 1 or 1 -> 0)	Input filter configurable from 1, 2, 5...500 ms	Input filter configurable from 1, 2, 5...500 ms	-
Test pulse outputs	8	4	-
Input current per channel			
At input voltage	24 V DC / 7 mA typically	24 V DC / 7 mA typically	-
	5 V DC / < 1 mA	5 V DC / < 1 mA	-
	15 V DC / > 4 mA	15 V DC / > 4 mA	-
	30 V DC / < 8 mA	30 V DC / < 8 mA	-
Digital outputs			
Number of channels per module	-	8 (SIL3)	-
Transistor outputs 24 V DC, 0.5 A	-	●	-
Transistor outputs 24 V DC, 2 A	-	● (1)	-
Switching of 24 V load	-	●	-
Safety relay outputs	-	● (2)	-
Output current			
Nominal current per channel	-	500 mA at UP = 24 V	-
Maximum (total current of all channels)	-	4 A / 500 mA / channel	-
Residual current at signal state 0	-	< 0.5 mA	-
Demagnetization when switching off inductive loads	-	By internal suppressor diodes	-
Switching frequency			
Short-circuit / overload proofness	-	●	-
For inductive load	-	On request	-
For lamp load	-	On request	-
Proofness against reverse feeding of 24 V signals	-	●	-

(1) Transistor outputs 24 V DC, 2 A. For details, please see application notes in chapter 8.

(2) Safety relay outputs using external safety relay, e.g. ABB BSR23. For details, please see application notes in chapter 8.

AC500-S and AC500-S-XC

Technical data

S500 and S500-XC Safety I/O

Type	DI581-S / DI581-S-XC	DX581-S / DX581-S-XC	AI581-S / AI581-S-XC
Analog inputs			
Number of channels per module	-	-	4 (SIL2) / 2 (SIL3)
Input resistance per channel	-	-	125 Ohm
Time constant of the input filter	-	-	10 ms
Conversion cycle	-	-	0.33 ms
Overvoltage protection	-	-	-
Signal resolution for channel configuration			
0...20 mA, 4...20 mA	-	-	14 bits
Process voltage UP			
Nominal voltage	24 V DC		
Maximum ripple	5 %		
Reverse polarity protection	●		
Fuse for process voltage UP	10 A miniature fuse		
Connections for sensor voltage supply Terminal 24 V and 0 V	●		
Conversion error of analog values caused by non-linearity, calibration errors ex and the resolution in the nominal range	-	-	±1.5 %
Maximum cable length for connected process signals			
Shielded cable	1000 m	1000 m	-
Unshielded cable	600 m	600 m	-
Max. line length of the analog lines, conductor cross section > 0.14 mm ²	-	-	100 m
Potential isolation			
Per module	●		
Fieldbus connection	Via AC500 CPU or PROFINET communication module		
Voltage supply for the module	Internally via extension bus interface (I/O bus)		
Approvals	CE, cUL, UL, C-Tick and other on request		

AC500-S

System data

Operating and ambient conditions

Voltages according to EN 61131-2

24 V DC	Process and supply voltage	24 V (-15 %, +20 %)
	Protection against reverse polarity	Yes
Allowed interruptions of power supply acc. to EN 61131-2	DC supply	Interruption < 10 ms, time between 2 interruptions > 1 s

Important: Exceeding the maximum process and supply voltages could lead to unrecoverable damage of the system. The system could be destroyed.

Temperature

Operating	0 °C ... +60 °C	horizontal mounting of modules
	0 °C ... +40 °C	vertical mounting of modules and output load reduced to 50 % per group
Storage / Transport	-40 °C ... +70 °C	

Humidity

Operating / Storage	Max. 95 %, without condensation
---------------------	---------------------------------

Air pressure

Operating	> 800 hPa / < 2000 m
Storage	> 660 hPa / < 3500 m

Creepage distances and clearances

Insulation Test Voltages, Routine Test, according to EN 61131-2	AC voltage during 2 seconds
24 V circuits (supply, 24 V inputs/outputs), if they are electrically isolated against other circuitry	350 V

The creepage distances and clearances meet the requirements of the overvoltage category II, pollution degree 2.

AC500-S

System data

Power supply units

For the supply of the modules, power supply units according to PELV specifications must be used.

Electromagnetic Compatibility

Immunity		
Against electrostatic discharge (ESD)		
Electrostatic voltage in case of	air discharge	±8 kV
	contact discharge	±6 kV
ESD with communication connectors		
In order to prevent operating malfunctions, it is recommended that the operating personnel discharge themselves prior to touching communication connectors or perform other suitable measures to reduce effects of electrostatic discharges.		
ESD with connectors of Terminal Bases		
The connectors between the Terminal Bases and CPUs or Communication Modules must not be touched during operation. The same is valid for the I/O-Bus with all modules involved.		
Against the influence of radiated (CW radiated)		
Test field strength		10 V/m
Against transient interference voltages (burst)		
Supply voltage units	DC	2 kV
Digital inputs/outputs	24 V DC	2 kV
Analog inputs		1 kV
Against the influence of line-conducted interferences (CW conducted)		
Test voltage		10 V zone B
High energy surges		
Power supply	DC	1 kV CM (1) / 0.5 kV DM (2)
DC I/O supply, add. DC-supply-out		0.5 kV CM (2) / 0.5 kV DM (2)
I/O analog, I/O DC unshielded		1 kV CM (2) / 0.5 kV DM (2)
Radiation (radio disturbance)		
In accordance with EN 55011, group 1, class A		

(1) High requirement for shipping classes is achieved with additional specific measures (see specific documentation).

(2) CM = Common Mode; DM = Differential Mode.

Mechanical Data

Wiring method / terminals	
Mounting	Horizontal (DIN rail mounting)
Degree of protection	IP20
Housing	In accordance with UL 94
Vibration resistance acc. to EN 61131-2	all three axes (DIN rail mounting) 5...11.9 Hz, continuous 3.5 mm 11.9...150 Hz, continuous 1 g
Shock resistance	All three axes 15 g, 11 ms, half-sinusoidal
Mounting of the modules	
DIN rail according to DIN EN 50022	35 mm, depth 7.5 mm or 15 mm
Mounting with screws	Screws with a diameter of 4 mm
Fastening torque	1.2 Nm

AC500-S-XC

System data

Operating and ambient conditions

Voltages according to EN 61131-2

24 V DC	Process and supply voltage	24 V (-15 %, +20 %)
	Protection against reverse polarity	Yes
Allowed interruptions of power supply acc. to EN 61131-2	DC supply	Interruption < 10 ms, time between 2 interruptions > 1 s

Important: Exceeding the maximum process and supply voltages could lead to unrecoverable damage of the system. The system could be destroyed.

Temperature

Operating	-40 °C ... +70 °C	horizontal mounting of modules
	-40 °C ... +40 °C	vertical mounting of modules and output load reduced to 50 % per group
Storage / Transport	-40 °C ... +85 °C	

Humidity

Operating / Storage	Max. 100 %, with condensation
---------------------	-------------------------------

Air pressure

Operating	620...1080 hPa / (-1000...4000 m) > 2000 m (< 795 hPa): max. operating temperature must be reduced by 10 °C.
Storage	> 620 hPa / < 4000 m

Creepage distances and clearances

Insulation Test Voltages, Routine Test, according to EN 61131-2	AC voltage during 2 seconds
24 V circuits (supply, 24 V inputs/outputs), if they are electrically isolated against other circuitry	350 V

The creepage distances and clearances meet the requirements of the overvoltage category II, pollution degree 2.

AC500-S-XC

System data

Power supply units

For the supply of the modules, power supply units according to PELV specifications must be used.

Electromagnetic Compatibility

Immunity		
Against electrostatic discharge (ESD)		
Electrostatic voltage in case of	air discharge	±8 kV
	contact discharge	±6 kV
ESD with communication connectors		
In order to prevent operating malfunctions, it is recommended that the operating personnel discharge themselves prior to touching communication connectors or perform other suitable measures to reduce effects of electrostatic discharges.		
ESD with connectors of Terminal Bases		
The connectors between the Terminal Bases and CPUs or Communication Modules must not be touched during operation. The same is valid for the I/O-Bus with all modules involved.		
Against the influence of radiated (CW radiated)		
Test field strength		10 V/m
Against transient interference voltages (burst)		
Supply voltage units	DC	2 kV
Digital inputs/outputs	24 V DC	2 kV
Analog inputs		1 kV
Against the influence of line-conducted interferences (CW conducted)		
Test voltage		10 V zone B
High energy surges		
Power supply	DC	1 kV CM (1) / 0.5 kV DM (2)
DC I/O supply, add. DC-supply-out		0.5 kV CM (2) / 0.5 kV DM (2)
I/O analog, I/O DC unshielded		1 kV CM (2) / 0.5 kV DM (2)
Radiation (radio disturbance)		
In accordance with EN 55011, group 1, class A		

(1) High requirement for shipping classes is achieved with additional specific measures (see specific documentation).

(2) CM = Common Mode; DM = Differential Mode.

Mechanical Data

Wiring method / terminals	
Mounting	Horizontal (DIN rail mounting)
Degree of protection	IP20
Housing	In accordance with UL 94
Vibration resistance acc. to EN 61131-2	all three axes (DIN rail mounting) 5...11.9 Hz, continuous 3.5 mm 11.9...150 Hz, continuous 1 g
Shock resistance	All three axes 15 g, 11 ms, half-sinusoidal
Mounting of the modules	
DIN rail according to DIN EN 50022	35 mm, depth 7.5 mm or 15 mm
Mounting with screws	Screws with a diameter of 4 mm
Fastening torque	1.2 Nm

CP600-eCo, CP600 and CP600-Pro

Control panels

257	Key features
258–259	Ordering data
260–262	Technical data

← → 15:38:22
10 Jul 2023

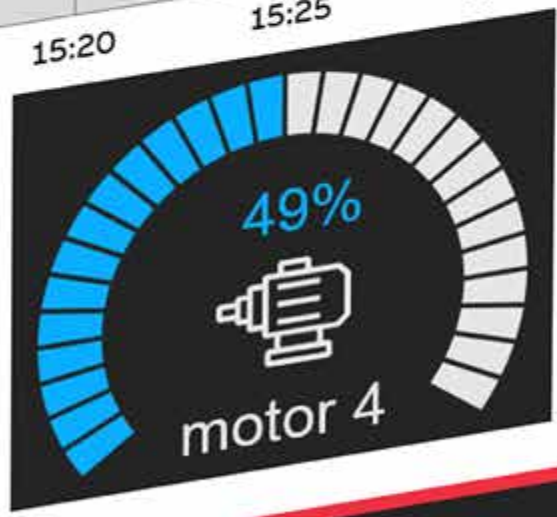
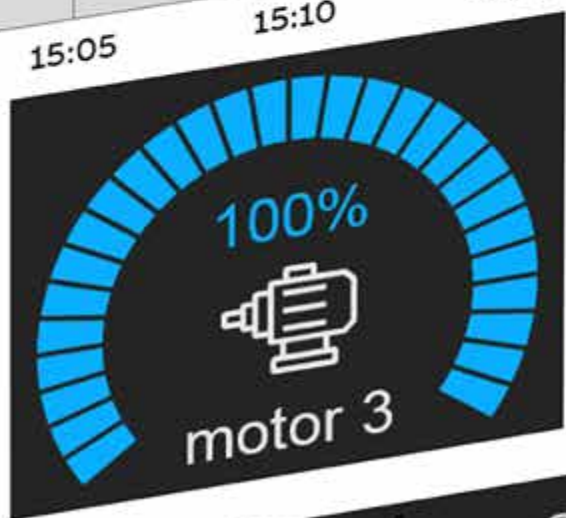
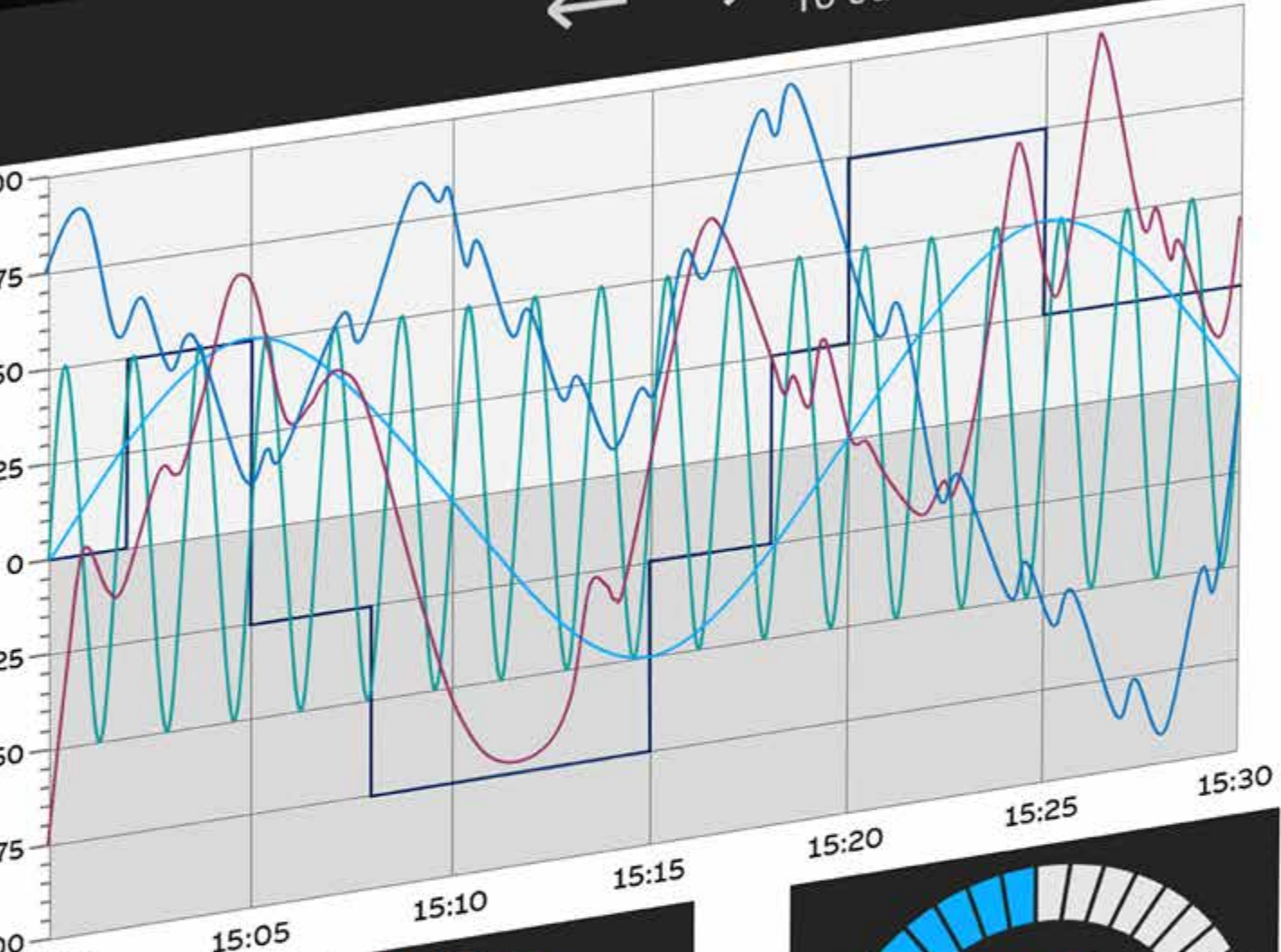

HVAC

Chiller

Alarm

e 2

CP600-eCo, CP600 and CP600-Pro

Key features

Various options for tailor-made HMI solutions:

- PB610 Panel Builder 600 HMI applications
- Visualization of AC500 web servers (V3)
- Mobile remote access to HMI applications
- PB610-R PC runtime for Windows platforms
- Drivers for integration into automation systems
- OPC UA as well as MQTT



CP600

- Brilliant display
- Aluminum enclosure
- Operating temperature: -20...+60 °C
- Three different screen sizes
- Usable as web panel

CP600-Pro

- Multi-touch
- Brilliant real glass screen
- Aluminum enclosure
- Fast ETH 10/100/1000
- Operating temperature: -20...+60 °C
- Five different screen sizes from 5" to 21.5"
- Usable as web panel

CP600-eCo

- Slim design for easy installation even in compact spaces
- Robust plastic enclosure
- Three different screen sizes
- CP610 usable as web panel

CP600-eCo, CP600 and CP600-Pro

Ordering data

CP600-eCo control panels

Display size	Resolution pixels	Description	Type	Order code	Weight (1 pce) kg
4.3"	480 x 272	for PB610 applications	CP604	1SAP504100R0001	0.290
7.0"	800 x 480	for PB610 applications	CP607	1SAP507100R0001	0.500
10.1"	1024 x 600	for PB610 applications or visualization of AC500 V3 web server	CP610	1SAP510100R0001	0.820
4.3"	480 x 272	black, for PB610 applications	CP604-B	1SAP504100R2001	0.290
7.0"	800 x 480	black, for PB610 applications	CP607-B	1SAP507100R2001	0.500
10.1"	1024 x 600	black, for PB610 applications or visualization of AC500 V3 web server	CP610-B	1SAP510100R2001	1.300

Visualization of AC500 V3 web server is supported by products with revision index C1 or higher.



CP604



CP607



CP610



CP607-B

CP600 control panels

Display size	Resolution pixels	Description	Type	Order code	Weight (1 pce) kg
7"	800 x 480	for PB610 applications or visualization of AC500 V3 web server	CP6407	1SAP540710R0001	0.920
10.4"	800 x 600	for PB610 applications or visualization of AC500 V3 web server	CP6410	1SAP541010R0001	1.820
15"	1024 x 768	for PB610 applications or visualization of AC500 V3 web server	CP6415	1SAP541510R0001	3.190



CP6407



CP6410



CP6415

CP600-eCo, CP600 and CP600-Pro

Ordering data

CP600-Pro control panels

Display size	Resolution pixels	Description	Type	Order code	Weight (1 pce) kg
5.0"	800 x 480	for PB610 applications or visualization of AC500 V3 web server	CP6605	1SAP560510R0001	0.740
7.0"	800 x 480	for PB610 applications or visualization of AC500 V3 web server (1)	CP6607	1SAP560710R0001	1.000
10.1"	1280 x 800	for PB610 applications or visualization of AC500 V3 web server (1)	CP6610	1SAP561010R0001	1.700
15.6"	1366 x 768	for PB610 applications or visualization of AC500 V3 web server (1)	CP6615	1SAP561510R0001	3.330
21.5"	1920 x 1080	for PB610 applications or visualization of AC500 V3 web server	CP6621	1SAP562110R0001	5.800

(1) Can be used to trigger safety actions in combination with AC500-S.



CP6605



CP6610



CP6621

Accessories

Description	Type	Order code	Weight (1 pce) kg
Communication cable RS232: CP600-eCo, CP600 <-> AC500 V2	TK681	1SAP500981R0001	0.120
Communication cable RS485: CP600-eCo, CP600 <-> AC500-eCo V2	TK682	1SAP500982R0001	0.130
Installation accessory bag for CP600-Pro	TK6028	1SAP506028R0001	0.140
Installation accessory bag for CP600-eCo, CP600	TK6031	1SAP506031R0001	0.160

Programming software licenses

Description	Type	Order code	Weight (1 pce) kg
PB610 Panel Builder 600, engineering tool license for CP600-eCo, CP600, CP600-Pro control panels and PB610-R PC-runtime, for stand-alone installation via Automation Builder installer. PB610 is included in Automation Builder Standard.	PB610	1SAP500900R0101	0.010
PB610-R Panel Builder 600 runtime license for running a PB610 application on one Windows 32-/64-Bit platform. Installation via Automation Builder installer.	PB610-R	1SAP500901R0101	0.010

CP600-eCo series

Technical data

Type	CP604 CP604-B	CP607 CP607-B	CP610 CP610-B
Application	control panels for PB610 Panel Builder 600 applications		visualization of AC500 V3 web server (1)
	-	-	
Display			
Exact display size diameter	4.3" widescreen	7" widescreen	10.1" widescreen
Resolution	480 x 272 pixels	800 x 480 pixels	1024 x 600 pixels
Display type, colors	TFT-LCD, 65536 colors		
Touch screen material	glass covered by plastic film		
Touch screen type	single-touch, analog resistive, 4 wires		
Backlight type, life	LED, 20 000 h typ at 25 °C		
Brightness	150 cd/m ²	200 cd/m ²	
System resources			
Processor type	ARM Cortex-A8; 300 MHz	ARM Cortex-A8; 300 MHz	ARM Cortex-A8; 1 GHz
Operating system, version	Linux RT		
Application memory	for HMI projects of 30 MB in total plus 30 MB for fonts		
Interfaces			
Ethernet ports, number, type	1 - 10/100 Mbit		
USB Host ports number, type	1 - ver. 2.0		
Serial ports number, type	1 - RS-232/-485/-422 software configurable		
Card slot number, type	none		
Power supply			
Power supply voltage nominal, tolerance	24 V DC, 18...32 V DC		
Current consumption at nominal voltage	0.25 A	0.3 A	0.4 A
Backup power type	Supercapacitor, 72 h at 25 °C		
Enclosure			
Degree of protection front, rear	IP66, IP20		
Front frame material	Plastic		
Reverse side material	Plastic		
Weight	0.4 kg	0.6 kg	1.0 kg
Faceplate dimensions (L x H)	147 mm x 107 mm	187 mm x 147 mm	282 mm x 197 mm
Faceplate depth	5 mm		6 mm
Enclosure depth	29 mm		
Cutout dimensions (L x H)	136 mm x 96 mm	176 mm x 136 mm	271 mm x 186 mm
Environmental conditions			
Operating temperature range	0...50 °C		
Operating humidity range	5...85 % relative humidity, non-condensing		
Storage temperature range	-20...+70 °C		
Storage humidity range	5...85 % relative humidity, non-condensing		
Approvals	See detailed page 284 or new.abb.com/plc		

(1) Supported by products with revision index C1 or higher

CP600 series

Technical data

Type	CP6407	CP6410	CP6415
Application	control panels for PB610 Panel Builder 600 applications or visualization of AC500 V3 web server		
Display			
Exact display size diameter	7" widescreen	10.4"	15"
Resolution	800 x 480 pixels	800 x 600 pixels	1024 x 768 pixels
Display type, colors	TFT-LCD, 65536 colors		
Touch screen material	glass covered by plastic film		
Touch screen type	single-touch, analog resistive, 4 wires		
Backlight type, life	LED, 40 000 h typ at 25 °C		
Brightness	400 cd/m ²		
System resources			
Processor type	ARM Cortex-A8; 1 GHz		
Operating system, version	Linux RT		
Application memory	150 MB		
Interfaces			
Ethernet ports, number, type	2 - 10/100 Mbit (with integrated bridge function)		
USB Host ports number, type	2 - ver. 2.0		
Serial ports number, type	1 - RS-232/-485/-422 software configurable		
Card slot number, type	1 - Memory card slot		
Power supply			
Power supply voltage nominal, tolerance	24 V DC, 18...32 V DC		
Current consumption at nominal voltage	0.35 A	0.4 A	0.7 A
Backup power type, capacity	Rechargeable Lithium battery, not user-replaceable		
Enclosure			
Degree of protection front, rear	IP66, IP20		
Front frame material	aluminum		
Reverse side material	aluminum		
Weight	1 kg	2 kg	3.3 kg
Faceplate dimensions (L x H)	187 mm x 147 mm	287 mm x 232 mm	392 mm x 307 mm
Faceplate depth	4 mm		
Enclosure depth	40 mm	40 mm	45 mm
Cutout dimensions (L x H)	176 mm x 136 mm	276 mm x 221 mm	381 mm x 296 mm
Environmental conditions			
Operating temperature range	-20...+60 °C		
Operating humidity range	5...85 % relative humidity, non-condensing		
Storage temperature range	-20...+70 °C		
Storage humidity range	5... 85 % relative humidity, non-condensing		
Approvals	See detailed page 284 or new.abb.com/plc		

CP600-Pro series

Technical data

Type	CP6605	CP6607	CP6610	CP6615	CP6621
Application	control panels for PB610 Panel Builder 600 applications or visualization of AC500 V3 web server				
Display					
Exact display size diameter	5" widescreen	7" widescreen	10.1" widescreen	15.6" widescreen	21.5" widescreen
Resolution	800 x 480 pixels	800 x 480 pixels	1280 x 800 pixels	1366 x 768 pixels	1920 x 1080 pixels
Display type, colors	TFT-LCD, 65536 colors	TFT-LCD, 16 Mio colors			
Touch screen material	true glass, black passepartout				
Touch screen type	multi-touch, 2-points gestures, PCAP, projected capacitive touchscreen				
Backlight type, life time	LED, 40 000 h typ at 25 °C				
Brightness	300 cd/m ²	500 cd/m ²	500 cd/m ²	400 cd/m ²	300 cd/m ²
System resources					
Processor type	ARM Cortex-A8; 1 GHz	ARM Cortex-A9 dual core; 800 MHz	ARM Cortex-A9 dual core; 800 MHz	ARM Cortex-A9 quad core; 800 MHz	ARM Cortex-A9 quad core; 800 MHz
Operating system, version	Linux RT				
Application memory	for HMI projects of up to 240 MB in total				
Interfaces					
Ethernet ports, number, type	2 - 10/100 Mbit (with integrated bridge function)	2 - 10/100 Mbit (with integrated bridge function) 1 - 10/100/1000 Mbit			
USB Host ports, number, type	1 - ver. 2.0	2 - ver. 2.0			
Serial ports number, type	1 - RS-232/-485/-422 software configurable				
Card slot number, type	1 - Memory card slot				
Power supply					
Power supply voltage nominal, tolerance	24 V DC, 18...32 V DC				
Current consumption at nominal voltage	1.0 A	0.7 A	1.0 A	1.2 A	1.7 A
Backup power type, capacity	Rechargeable Lithium battery, not user-replaceable				
Enclosure					
Degree of protection front, rear	IP66, IP20				
Front frame material	aluminum, black				
Reverse side material	aluminum				
Weight	1.3 kg	1.3 kg	1.7 kg	4.1 kg	6.1 kg
Faceplate dimensions (L x H)	147 mm x 107 mm	187 mm x 147 mm	282 mm x 197 mm	422 mm x 267 mm	552 mm x 347 mm
Faceplate depth	8.5 mm	8.5 mm	8.5 mm	8.5 mm	8.5 mm
Enclosure depth	52 mm	47 mm	52 mm	56 mm	56 mm
Cutout dimensions (L x H)	136 mm x 96 mm	176 mm x 136 mm	271 mm x 186 mm	411 mm x 256 mm	541 mm x 336 mm
Environmental conditions					
Operating temperature range	-20...+60 °C				
Operating humidity range	5...85 % relative humidity, non-condensing				
Storage temperature range	-20...+70 °C				
Storage humidity range	5...85 % relative humidity, non-condensing				
Approvals	See detailed page 284 or new.abb.com/plc				

Additional information

266–267	Cyber security
268–271	PLC training
272–273	PLC support
274–275	AC31 adapter for retrofitting existing AC31 applications, AC31 adapter for spare parts
276–277	AC31 adapter
278	Services
279	Life cycle management
280–282	ABB Ability™ Automation Builder product life cycle plan
283	Generic composition of type designation
284–290	Certifications

Cyber security Information



Introduction

Cyber security is one of the most important topics for ABB and its customers. With the adoption of Industry 4.0 and IoT more and more devices are connected with each other. This is why the security of industrial automation and control systems is increasingly critical. ABB aims to protect the data, integrity and availability of all AC500 PLC products from I/O modules to the engineering software.

How ABB PLC products meet security challenges

ABB takes all necessary steps to continuously improve the security of its products. These measures follow commonly accepted industry standards and practices and include, where technically feasible:

- Robustness testing, including fuzzing and flooding
- Vulnerability scanning for known vulnerabilities and exploits
- Security testing, including static code analysis or binary code analysis.

We highly recommend that all software, firmware, libraries and applications are kept up to date using the most recent firmware and software updates to keep your system and environment secure.

TÜV SÜD certification for AC500 according to IEC 62443

We are pleased to announce that TÜV SÜD has certified

- the ABB AG site in Heidelberg in accordance to the **IEC 62443-4-1:2018** standard (Secure Product Development Lifecycle). This confirms that ABB develops secure-by-design products in accordance with the IEC 62443-4-1 process.
- the AC500 product in accordance with the **IEC 62443-4-2:2019** standard (Security for industrial automation components). This confirms the security level of AC500.

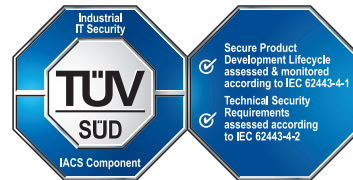

**Designing secure automation systems**

Before any deployment of standard and functional safety applications with ABB PLC products a threat model should be created for the automation system.

- The required security measures will depend on the threat model and the selected security standards for the given application and implemented at the overall system level.
- For example IEC 62443-3-3 “Industrial communication networks – Network and system security” standard can be used.

Additional information

For additional information and support, please contact your local ABB service organization.

Information about ABB’s cyber security program and capabilities:

global.abb/group/en/technology/cyber-security

global.abb/group/en/technology/cyber-security/alerts-and-notifications

In addition, you will find the AC500 PLC cyber security white paper and the IEC 62443 related certificates at:

new.abb.com/plc/documentsanddownloads



PLC training Offering



High-quality training is our priority: Our instructors are highly skilled and experienced, having worked internationally with many people from different cultures and backgrounds. Their training is not only professional and efficient but can also be tailored to meet your needs.

Supported by one of the world's most extensive global sales and service networks, we offer PLC and Automation Builder software training designed for engineering, operation, and maintenance of PLC automation solutions.

Learn online through our video tutorials, eLearning or application examples and attend our classroom training sessions.

- [ABB University course locator](#)
- [Application examples selector](#)
- [Channel partner program](#)
- [PLC Training and Support](#)

ABB provides training and technical support guiding you to the ideal PLC Automation products for your applications.

Participants in our training will be able to understand complex topics and apply what they have learned in their daily work. We are the perfect partner for your success.

For more information, please visit new.abb.com/plc/training or contact your local sales organization.



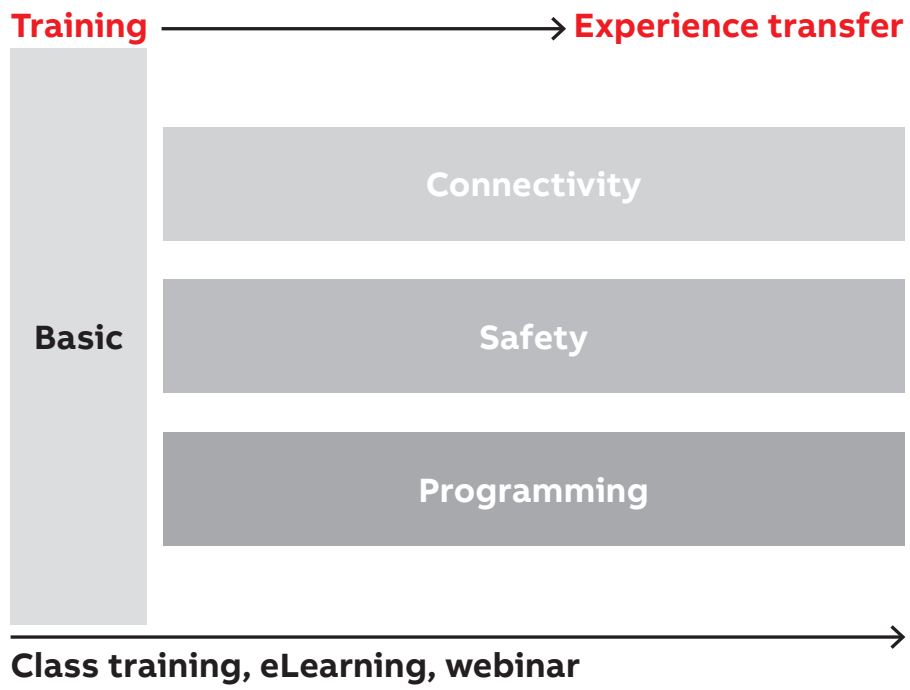

PLC training

Training cases

AC500 training cases help you to get familiar with ABB AC500 PLC offerings and the engineering tool ABB Ability™ Automation Builder.

For more information, please see new.abb.com/plc/training.



01



02

—
01 AC500 training case
For details, please
see page 158.

—
02 AC500-S training
case
For details, please
see page 244.

Training cases	Description	Type	Order code	Weight (1 pce) kg
AC500 V2 training case	PM585-ETH + TB521-ETH + CM579-PNIO + DA501 + CI502-PNIO + CP6607 + Case + 115-230 V AC power supply + Ethernet cables + demo program + memory card + simulation stand	TA515-CASE	1SAP182400R0002	7.0
AC500 V3 training case	PM5630-2ETH + TB5620-2ETH + CM579-PNIO + DA501 + CI502-PNIO + CP6607 + Case + 115-230 V AC power supply + Ethernet cables + demo program + memory card + simulation stand	TA5450-CASE	1SAP187700R0001	7.0
AC500-S safety PLC training case	SM560-S, DI581-S, DX581-S, AI581-S, TU582-S with PM573-ETH and PNIO	TA514-SAFETY	1SAP182900R0001	10.0

PLC training

AC500-eCo Starter kits

AC500-eCo Starter kit

The AC500-eCo Starter kit helps you to get familiar with ABB AC500 PLC offerings and the engineering tool within a very short time. Learn how to connect and setup the components provided in the starter kit and how to program the PLC by means of several simple example applications. The starter kit comes with CPU, programming cable, digital input simulator and getting started instructions. The latest version of the engineering tool Automation Builder is available via download.

Easy to use

The AC500-eCo from ABB is a range of uniquely scalable PLCs offering you unrivalled cost effectiveness for modern industrial automation applications. The AC500-eCo integrates perfectly into the AC500 family - this provides you with the option to build customized solutions based on the standard S500 and S500-eCo I/O range.

Easy to learn

Offering all of the advantages you would expect from the AC500 family of devices, the AC500-eCo delivers an impressive set of powerful programming features. In addition, thanks to the fact that ABB uses a standard IEC 61131-3 based programming system for the entire AC500 family, it is a snap to learn and configure.

Ordering data

The kits contain the devices, programming cable and digital input simulator. The engineering tool is available for download at new.abb.com/plc/automationbuilder.



[AC500-eCo Starter kit leaflet](#)



Starter kit	CPU module in the starter kit	HMI in the kit	Type	Order code	Weight (1 pce) kg
AC500-eCo V3 Starter kit	PM5032-T-ETH	-	TA5415-STAKIT (1)	1SAP187600R0002	0.591
	PM5072-T-2ETH	CP604	TA5426-STAKIT (1)	1SAP187600R0003	1.011

PLC support

Application examples selector



ABB Ability™ Automation Builder is the integrated engineering suite for machine builders and system integrators. ABB Automation Builder covers the engineering of ABB PLCs, safety PLCs, control panels, drives and motion.

- Application examples contain specific programming descriptions for different communication protocols and automation components and include a project.
- Application notes contain general descriptions about how our products can be used in different applications.

Project conversion from AC500 V2 to V3

The application note guides a user how to upgrade an existing AC500 V2 project to AC500 V3 PLCs. A direct one-to-one conversation is not possible and manual adaptation has to be done.

Modbus TCP communication

This application example shows easy ways to read or write data from and to a server. Modbus provides special function codes like 22 and 23 to read and write data in one job. This reduces the load on the line.

Application Examples Selector



OPC UA – configuration and handling

OPC UA is mostly used to exchange data between SCADA, DCS and management applications. This application note describes how AC500 V3 can act as OPC UA client and server. Both types provide the feature to encrypt the communication via the TLS V1.2 standard.

MQTT – cloud connectivity

Since more and more customers want to store their data on a cloud service, we have decided to update this application example to easily show customers how to publish data to the cloud and to subscribe (receive) data back from the cloud to the PLC. This example not only covers the AC500 part, but also includes a configuration example of the required Microsoft Azure components.

Triggering safety actions using standard HMIs

The application note describes the AC500/AC500-S system configuration, programming approach, safety calculation and requirements for standard HMIs for triggering safety actions using them. Standard HMIs that support at least two different Ethernet-based communication protocols can be used. ABB recommends Modbus TCP and ABB ETH communication. A mean time between failures (MTBF) greater than 22.5 years is required for standard HMIs to satisfy PL d (ISO 13849-1) requirements. HMIs with lower MTBFs may only satisfy PL c (ISO 13849-1) requirements.

AC500-S DX581-S safety I/O with ABB safety relays BSR23

The application note provides technical details on using the DX581-S safety I/O module with ABB BSR23 safety relays for the potential-free switching of 6 A / 5 A (24 V DC / 250 V AC) electrical loads, such as big safety contactors or safety valves. Typical wiring examples and information related to safety calculations are included. Explanations of using the PLCopen safety FBs delivered with the AC500-S safety PLC in the safety application program to supervise the state of safety relay contacts are provided.

Using DX581-S safety digital outputs with 2 A 24 V DC electrical loads

The application note describes how the DX581-S safety I/O module developed for electrical loads with up to 500 mA 24 V DC can be used for switching 2 A 24 V DC electrical loads such as big safety power contactors, etc. Details for wiring, channel configuration and safety calculation are provided.

PROFINET – configuration and engineering

This application example describes how to configure and set up a PROFINET communication with Automation Builder V2.0.x. The detailed step-by-step instruction shows all necessary steps and describes the relevant parameters, which have to be set carefully to establish a reliable and robust PROFINET communication.



AC31 adapter for retrofitting existing AC31 applications

AC500 life cycle management

A long history

During more than 50 years in the PLC business, we have gained experience from hardwired, centralized and distributed PLCs to scalable PLCs. One of our previous product ranges, the AC31 series 90, was succeeded by the AC500 PLC platform.

For the protection of your investments and for ease of migration to the new AC500 PLC generation, ABB provides AC31 adapter modules based on AC500.

The modules have the same footprint, cabling and features as the previous AC31 series 90 products with up-to-date AC500 hardware.

AC31 adapter modules can replace existing AC31 devices with either direct compatible e.g. I/O modules or need adjustments with a new user program for the CPU using Automation Builder software.

Main characteristics and architecture

The connection locations do not differ from the predecessor hardware and the number or type of I/O channels are comparable. For remote I/O products on the CS31 bus, I/Os of an existing field application can be modified without having to change the application or configuration. New modules can be configured with DIP switches.

Replacing the AC31 PLC with the 07KT98-x-AD PLC requires to rewrite the application program using the Automation Builder engineering suite.

Advantages at a glance

- Compatible with the existing AC31 series 90 remote I/O-modules, in some cases with 1-to-1 replacement in the field, no change of application configuration required.
- Footprint identical to predecessor hardware.
- Automation Builder for PLC programming.
- Standard AC500 modules for seamless migration from AC31 to the new AC500.
- Longer life cycle of AC31 through migration to new solution.

Ordering details

For more information, please contact your local sales organization.

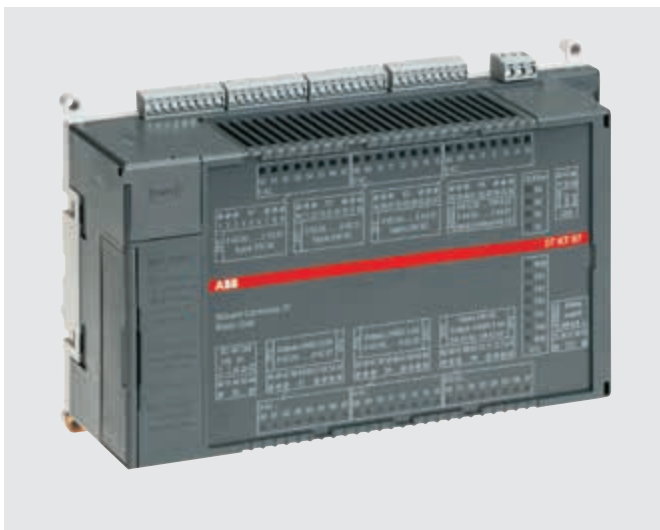

AC31 adapter for spare parts

AC500 life cycle management

Under certain conditions, the AC31 adapter I/O modules may be used as spare parts for existing applications where the previous AC31 modules were installed. The AC31 adapter modules can normally replace old modules without any changes in the configuration or application.

The new module is configured with DIP switches, the old one removed, the new one installed and the application started again.

The modules have the same footprint, cabling position and channel assignment. The AC31 adapter module supports most of the previous functionalities of the old module. There are only

a few exceptions and minor differences that are listed below:

- The AC31 adapter I/O modules can only be used, supported and tested with ABB AC31 master devices and cannot run with third party controllers.
- The AC31 adapter modules are based on standard AC500 I/O modules and on a specific electronic base, the modules cannot be purchased separately and are always delivered as complete devices. The pluggable electronic module cannot be replaced separately without the base.

For special applications, further details or specific questions regarding compatibility, please contact your local sales organization.



AC31 adapter

AC500 life cycle management

Replacement table and compatibility information

Previous AC31 I/O module			New AC31 adapter module			Difference in feature / feature not supported
Product number	Type	I/O combination	Order code	Type	I/O combination supported	
GJR5251400R0202	07DC91	16DI/8DO/8DC	1SAP800300R0010	07DC91-AD	16DI/16DC	No local test button, compatible with basic diagnostics only.
GJR5252200R0202	07DC92	32DC	1SAP800500R0010	07DC92-AD	32DC	Same electrical potential for all channels (no group isolation), input current only max. 2 mA per channel, max. 8 A current sum for all outputs, no local test button, compatible with basic diagnostics only.
GJR5251600R0202	07AI91	8 AI, U/I PT100 and thermocouple	1SAP800200R0010	07AI91-AD	8AI	Standard analog voltage or current inputs, PT100/1000 only up to 3-wire connection, no thermocouple support, linear approximation always on, no test button, only standard as in 07AI91.
GJR5252300R0101	07AC91	16 AC or 8 AI/8 AO	1SAP800000R0010	07AC91-AD	16AO	No 16 AI inputs but only 16 AO in 16 AC configuration, no local test button, compatible with basic diagnostics only.
			1SAP800100R0010	07AC91-AD2	8AI/8AO	No local test button, compatible with basic diagnostics only.

New AC31 adapter PLC module

Order code	Type	Communication	I/O combination supported	Difference in feature / feature not supported
1SAP801400R0060	07KT98-ARC-AD	ARCNET	16DI/16DO/16DC/8AI/4AO	Programming using Automation Builder software means that old AC31 user applications must be re-written and direct import of the old program is not possible. Libraries are different and not all features are supported. Only PROFIBUS DP Master is supported. Same footprint and I/O channel position as old AC31 07KT98 CPU.
1SAP801100R0062	07KT98-ARC-DP-AD	ARCNET, PROFIBUS DP Master	16DI/16DO/16DC/8AI/4AO	
1SAP801200R0062	07KT98-ARC-ETH-AD	ARCNET, Ethernet TCP/IP	16DI/16DO/16DC/8AI/4AO	
1SAP801300R0072	07KT98-ETH-DP-AD	Ethernet TCP/IP, PROFIBUS DP Master	16DI/16DO/16DC/8AI/4AO	
1SAP801500R0062	07KT98-ARC-ETH-DP-AD	ARCNET, Ethernet TCP/IP, PROFIBUS DP Master	16DI/16DO/16DC/8AI/4AO	

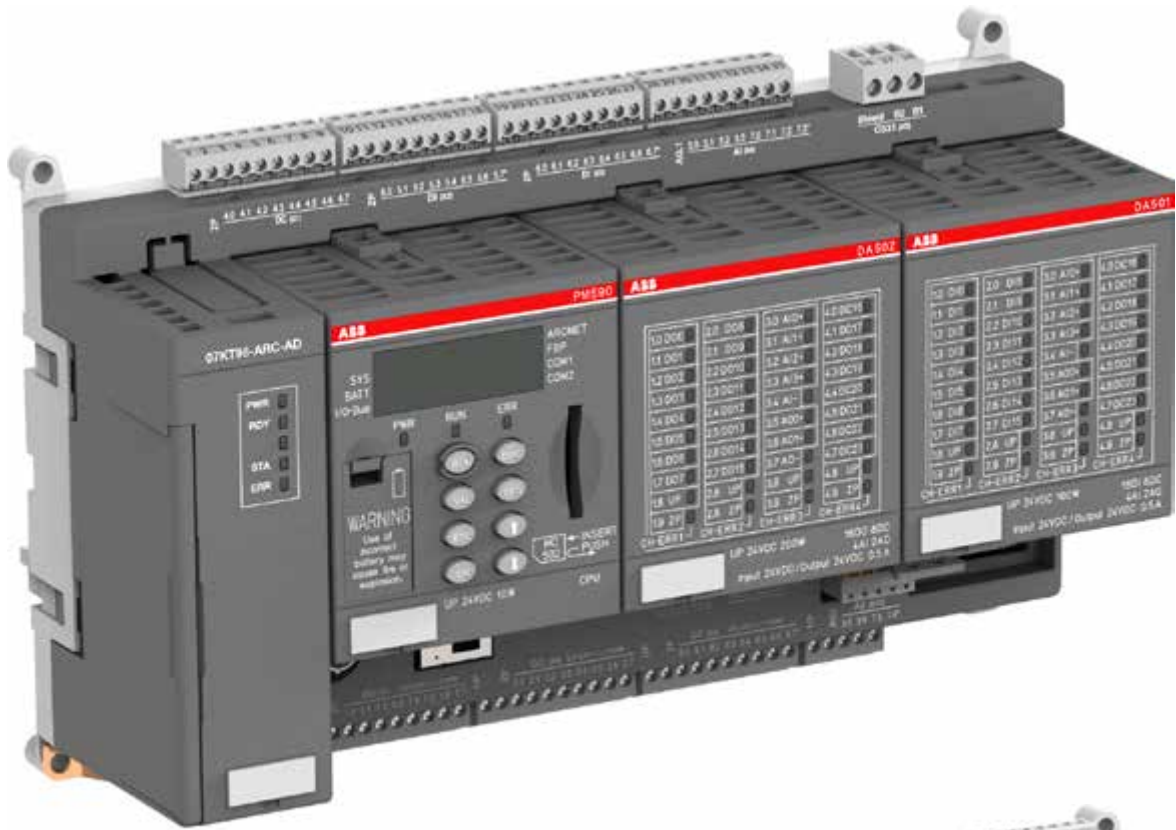

01 07KT98-ARC-AD



02 DC501-CS31-AD



03 07AC91-AD

Additional information Services

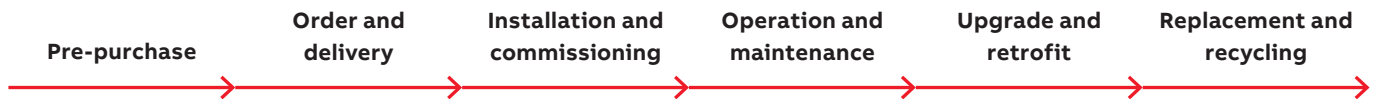

Services offered for ABB's automation products span the entire asset lifetime, from the moment a customer makes the first inquiry to disposal and recycling of the product. Throughout the life cycle of an asset, ABB provides training, technical support and customized contracts, supported by one of the world's most extensive global sales and service networks.

Pre-purchase

ABB provides a range of services and support guiding the customers to the ideal products for their applications.

Order and delivery

Orders can be placed at an ABB office or channel partner. In some countries, ABB also offers an online order tracking system. ABB's sales and service network ensures timely deliveries and also offers express delivery.

Installation and commissioning

While many customers have the resources to perform installation and commissioning on their own, ABB and its channel partners also offer professional installation and start-up services if requested.

Operation and maintenance

From maintenance assessments, preventive maintenance, reconditioning of spare parts and repairs on-site or in workshops, ABB has all the options covered to keep their customers' processes operational.

Upgrade and retrofit

Frequently, ABB products can often be upgraded to the latest software or hardware in order to improve the performance of the application. Existing processes can be economically modernized by retrofitting with up-to-date technology.

Replacement and recycling

ABB provides assistance in the best replacement of products while ensuring disposal and recycling observing the local environmental regulations.

ABB Access

Your key to 24/7 self-services for your ABB drives, motors and PLCs. Simply scan the QR code on the ABB product to get started. ABB Access helps you to easily find up-to-date product data online. It also provides easy access to documentation and manuals. If you happen to experience issues with your ABB product, this can be fastly and easily reported online to reach expert support from ABB.

new.abb.com/drives/mobile-tools/abb-access



Additional information

Life cycle management



Product life cycle management model

ABB has developed a PLC life cycle management model aimed at providing proactive services for maximizing availability and performance. This model not only provides optimum support to end-users but also a smooth transition to a new product when the PLC has come to the end of its lifetime.

The life cycle management model divides a product's life cycle into four phases: active, classic, limited and obsolete. Each phase has different implications for the end-user in terms of services provided.

Active phase

The active phase starts when the product is launched. In the active phase the end user benefits from different warranty options and other services such as training and technical support. Complete life cycle services from spare parts and maintenance are also provided. The active phase ends when the volume production of a particular PLC ceases and ABB issues an announcement of the life cycle phase change.

Classic phase

ABB PLC users continue to benefit from complete life cycle services throughout the classic phase. The classic phase is closely aligned with ABB's research and development work to provide continuing support for its PLC products while developing future generations. In the classic phase new hardware and software development may be required to provide the maintenance techniques and upgrades needed to guarantee that the PLC continues to operate at its peak performance. Migration to a new PLC product is recommended before the product has entered the limited phase.

Limited phase

In the limited phase the product development has come to its end. Spare parts are available as long as components and materials can be obtained. Towards the end of the limited phase, services gradually become obsolete. In addition to the annual life cycle status reviews, ABB issues a life cycle phase change announcement, half a year prior the product becoming obsolete. This is the last opportunity to transfer to new technology before product services end.

Obsolete phase

The product is transferred to the obsolete phase when it is no longer possible to provide services at reasonable cost or when ABB can no longer support the product technically or the old technology is not available.

Benefits of life cycle management

PLC life cycle management maximizes the value of the equipment and its maintenance investments by:

- ensuring spare parts and ABB competence availability throughout the lifetime
- enabling efficient product support and maintenance for improved reliability
- adding functionality to the initial product by upgrading or retrofitting
- providing a smooth transition to new technology at the end of the product lifetime.

For more information, please see new.abb.com/plc or contact your local sales organization.



Additional information

ABB Ability™ Automation Builder product life cycle plan

Product life cycle

ABB is committed to supporting our customers' installed system base. We want to optimize our customers' system investment and provide our customers with the confidence that there is a well-defined support and a path forward for existing ABB systems. ABB's product life cycle policy provides advanced notification of planned changes in product availability and support.

This chapter shall not be understood as legally binding. Users are recommended to keep informed about updates by periodically checking relevant life cycle information.

Predictive releases – continuous delivery

ABB continuously maintains and improves its software products. As part of this effort, we develop and release major versions, minor versions and service releases.

Major and minor releases deliver new features and quality improvements whereas service releases focus on corrections and quality improvements. A new service release supersedes and replaces existing service releases within the same major/minor release. All releases contain corrections to issues either identified in ABB test labs or reported by our customers.

Release Type	Designation example	Purpose and frequency
Major Release	1.x, 2.x	Deliver new features extending Automation Builder scope
Minor Releases	1.1.x, 1.2.x	Deliver new features within current Automation Builder scope
Service Releases	1.2.1, 1.2.2	Deliver corrections, improvements and updates of existing components

ABB aims for continuous, consistent and coordinated delivery of engineering tool versions and device firmware versions. It is recommended to always use the latest release of Automation Builder, which contains the latest device firmware versions.

Compatibility with installed base

ABB aims at maximizing availability and performance of the installed base. In this effort we follow these two principles: The engineering tool shall provide the latest features in best quality. The engineering tool and installed base shall always be compatible.

Up to Automation Builder 2.5 this has been realized by version profiles. A version profile contains all Automation Builder software components as released in the latest service release of a specific major/minor version, including respective device firmware versions.

Version profiles can be installed with every release of Automation Builder. Multiple version profiles can be installed in parallel. Each version profile goes through all product life cycle phases. Life cycle statements apply to each version profile and corresponding licenses. The availability of a version profile depends on the life cycle phase it is currently in.

Starting with Automation Builder 2.6, it allows side-by-side installation, i.e. specific versions can be installed or uninstalled on a need base.

All this allows our users to install the latest version of Automation Builder and keep compatibility with the installed base. Updates of the runtime system are avoided. The latest Automation Builder release always contains the best quality. New releases and important corrections are announced to all users by corresponding update notifications in Automation Builder.

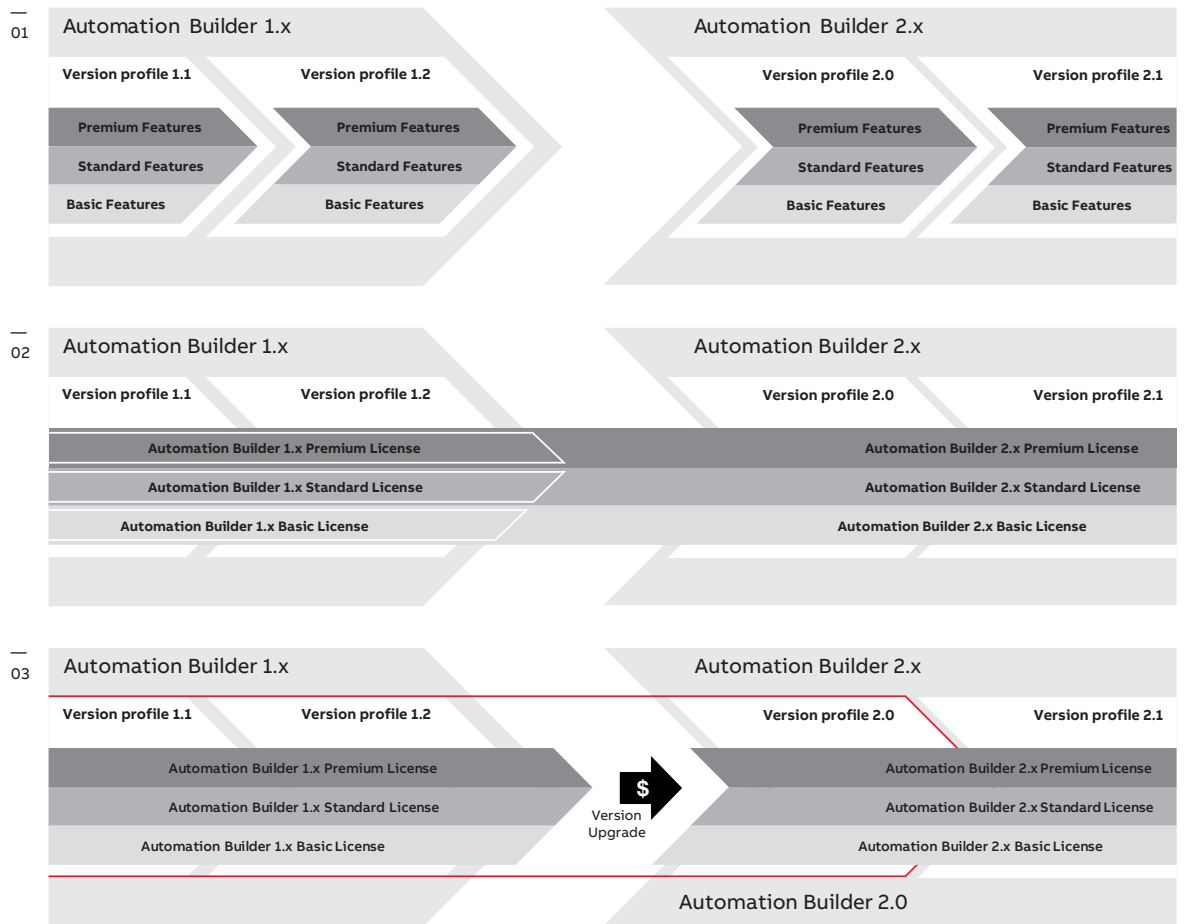

Automation Builder life cycle management model

The Automation Builder life cycle management model aims to provide service for maximizing availability and performance, support to end-users and a smooth transition to new product versions when the service life of the current product ends. The model divides a product’s life cycle into four phases: active, classic, limited and obsolete. Each phase has different implications for the end-user in terms of software and license availability, services and support provided.

Active	The software product with complete life cycle services is available.
Classic	The software product with complete life cycle services is available for system extensions and spare part engineering.
Limited	The software product is available without maintenance and further corrections. Migration to a newer version is recommended.
Obsolete	Migration to a newer version is recommended.

Version profiles and licenses

01 – Major versions come in several minor versions, e.g. Automation Builder 1.x comes as Automation Builder 1.1 and 1.2. Version profiles cover different sets of features, e.g. basic, standard and premium feature sets.

02 – To use a feature a license is required. The license defines which feature set can be used, e.g. a premium license enables you to use the premium feature set. A license corresponds to a major version of Automation Builder, e.g. Automation Builder 2.x Premium license enables to use Premium features in all 2.x minor versions and in all previous versions.

03 – There are two different cases where you have to purchase a new Automation Builder license:

- Edition upgrade: Need for a higher value license option within the same major version of Automation Builder, e.g. Automation Builder 2.x Premium instead of Standard.
- Version upgrade: Upgrade from one major Automation Builder version to another, e.g. Automation Builder 1.x to 2.x. – Note: Licenses for Automation Builder 1.x and Automation Builder 2.x can be used in parallel in order to support different version profiles.

Additional information

ABB Ability™ Automation Builder product life cycle plan

Life cycle phases

Active

The latest minor version of Automation Builder starts in life cycle phase Active. During the Active phase the version is available with complete life cycle services.

This means the version is available via Automation Builder installation manager from abb.com and will receive ABB's normal product maintenance including enhancements and corrections, and third party software updates.

The version is the base for current sales and active price list. Licenses can be purchased. Support and training is provided.

Classic

With release of the next major/minor version the predecing version is going into life cycle phase Classic. During the Classic phase, the version with complete life cycle services is available for system extensions and spare part engineering. Migration to the Active version is recommended.

Classic versions are available via Automation Builder installation manager from abb.com and will receive corrections only for critical issues. Classic versions are typically available as released in the latest respective service release (and additional corrections). New third party products (e.g. OS) are not supported anymore.

Licenses can be purchased. Training is not available anymore. Support is provided.

Limited

During the Limited phase, the version profile is available without maintenance and further corrections. Migration to the Active version is recommended.

It is no longer available from Automation Builder installation manager from abb.com, but could be obtained as offline installations via support. Corrections might be available upon request as billable service. New third party products (e.g. OS) are not supported anymore.

Licenses can be purchased. Training is not available anymore. Support is provided.

Obsolete

When entering the Obsolete phase, the version profile is not supported anymore. Migration to the Active version is strongly recommended.

This means it is not available anymore for installation. It will not receive corrections anymore.

Licenses can be purchased. Training is not available anymore. Support is not available anymore.

Additional information

Generic composition of type designation



The identification number starts with 5 for the AC500 PLC platform or 6 for the CP600 HMI platform.

Example: AC500-eCo V3 central processing unit

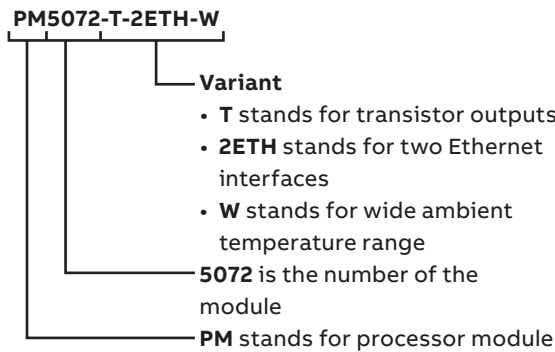

Prefix of module types

Letters	Meaning
AI	Analog input module
AO	Analog output module
AX	Analog input/output module (X stands for mixed input/output)
CD	Counter module
CI	Communication interface module for remote I/O station
CM	Communication module attached to the CPU
CP	Control panel (HMI)
DA	Mixed analog/digital input/output module
DC	Digital I/O module with channels configurable as inputs or outputs
DI	Digital input module
DM	PLC engineering software ABB Ability™ Automation Builder or add-ons
DO	Digital output module
DX	Digital input/output module (X stands for mixed input/output)
FM	Function module
MC	Memory card or memory card adapter
PB	Panel Builder engineering software for HMI
PM	PLC CPU module
PS	Application-specific function block libraries
SM	Safety CPU module
TA	Accessories and training cases
TB	Terminal base for CPU modules
TF	Terminal base for CPU with function modules
TK	Communication cable
TU	Terminal unit for I/O modules

Additional information

Certifications

Symbols and legends:

- Standard product certified: product label wears approval mark when mandatory
- ◐ Submitted (roadmap available upon request)
- Submission planned (roadmap available upon request)
- Submission not planned or not applicable for product

Name	Conformité Européenne	UKCA UK Conformity Assessed	SJ/T 11363-2006 (China RoHS)	Regulatory Compliance Mark (RCM)	Eurasian Conformity	Korea Certification	Underwriter Laboratories	American Bureau of Shipping	Bureau Veritas	DNV	Lloyds Register	RINA	Korean Register of Shipping	China Classification Society
Logo / Certification Mark														
Certificate	Declaration of Conformity LVD / EMC	Declaration of Conformity	Declaration of Conformity	Declaration of Conformity	Declaration of Conformity	Declaration of Conformity	cULus Ordinary Locations	cULus Hazardous Locations	Design Assessment	Type Approval	Type Approval	Type Approval	Type Approval	Type Approval
07AC91-AD	●	●	●	○	●	○	●	–	–	–	–	–	–	–
07AC91-AD2	●	●	●	○	●	○	●	–	–	–	–	–	–	–
07AI91-AD	●	●	●	○	●	○	●	–	–	–	–	–	–	–
07DC91-AD	●	●	●	○	●	○	●	–	–	–	–	–	–	–
07DC92-AD	●	●	●	○	●	○	●	–	–	–	–	–	–	–
07KT98-ARC-AD	●	●	●	○	●	○	●	–	–	–	–	–	–	–
07KT98-ARC-DP-AD	●	●	●	○	●	○	●	–	–	–	–	–	–	–
07KT98-ARC-ETH-AD	●	●	●	○	●	○	●	–	–	–	–	–	–	–
07KT98-ARC-ETH-DP-AD	●	●	●	○	●	○	●	–	–	–	–	–	–	–
07KT98-ETH-DP-AD	●	●	●	○	●	○	●	–	–	–	–	–	–	–
AC522	●	●	●	●	–	●	●	●	●	●	●	●	●	–
AC522-XC	●	●	●	●	–	●	●	●	●	●	●	●	●	–
AI523	●	●	●	●	●	●	●	●	●	●	●	●	●	●
AI523-XC	●	●	●	●	●	●	●	●	●	●	●	●	●	●
AI531	●	●	●	●	●	●	●	●	●	●	●	●	●	●
AI531-XC	●	●	●	●	●	●	●	●	●	●	●	●	●	●
AI561	●	●	●	●	●	●	●	●	●	●	●	●	●	–
AI562	●	●	●	●	●	●	●	●	●	●	●	●	●	–
AI563	●	●	●	●	●	●	●	●	●	●	●	●	●	–
AI581-S	●	●	●	●	●	●	●	●	●	●	●	●	●	○
AI581-S-XC	●	●	●	●	●	○	●	●	●	●	●	●	●	○
AO523	●	●	●	●	●	●	●	●	●	●	●	●	●	●
AO523-XC	●	●	●	●	●	●	●	●	●	●	●	●	●	●
AO561	●	●	●	●	●	●	●	●	●	●	●	●	●	–
AX521	●	●	●	●	●	●	●	●	●	●	●	●	●	●
AX521-XC	●	●	●	●	●	●	●	●	●	●	●	●	●	●
AX522	●	●	●	●	●	●	●	●	●	●	●	●	●	●
AX522-XC	●	●	●	●	●	●	●	●	●	●	●	●	●	●
AX561	●	●	●	●	●	●	●	●	●	●	●	●	●	–
CD522	●	●	●	●	●	●	●	●	●	●	●	●	●	–
CD522-XC	●	●	●	●	●	●	●	●	●	●	●	●	●	–
CI501-PNIO	●	●	●	●	●	●	●	●	●	●	●	●	●	○
CI501-PNIO-XC	●	●	●	●	●	●	●	●	●	●	●	●	●	○
CI502-PNIO	●	●	●	●	●	●	●	●	●	●	●	●	●	○
CI502-PNIO-XC	●	●	●	●	●	●	●	●	●	●	●	●	●	○
CI504-PNIO	●	●	●	●	●	●	●	●	●	●	●	●	●	○
CI504-PNIO-XC	●	●	●	●	●	●	●	●	●	●	●	●	●	○
CI506-PNIO	●	●	●	●	●	●	●	●	●	●	●	●	●	○
CI506-PNIO-XC	●	●	●	●	●	●	●	●	●	●	●	●	●	○

Symbols and legends:

- Standard product certified: product label wears approval mark when mandatory
- Submitted (roadmap available upon request)
- Submission planned (roadmap available upon request)
- Submission not planned or not applicable for product

Name	Conformité Européenne	UKCA Conformity Assessed	SJ/T 11363-2006 (China RoHS)	Regulatory Compliance Mark (RCM)	Eurasian Conformity	Korea Certification	Underwriter Laboratories	American Bureau of Shipping	Bureau Veritas	DNV	Lloyds Register	RINA	Korean Register of Shipping	China Classification Society	
Logo / Certification Mark															
Certificate	Declaration of Conformity LVD / EMC	Declaration of Conformity	Declaration of Conformity	Declaration of Conformity	Declaration of Conformity	Declaration of Conformity	cULus Ordinary Locations	cULus Hazardous Locations	Design Assessment	Type Approval	Type Approval	Type Approval	Type Approval	Type Approval	Type Approval
CI511-ETHCAT	●	●	●	●	●	●	●	●	●	●	●	●	●	-	-
CI512-ETHCAT	●	●	●	●	●	●	●	●	●	●	●	●	●	-	-
CI521-MODTCP	●	●	●	●	●	○	●	●	●	●	●	●	●	●	●
CI521-MODTCP-XC	●	●	●	●	●	○	●	●	●	●	●	●	●	●	●
CI522-MODTCP	●	●	●	●	●	○	●	●	●	●	●	●	●	●	●
CI522-MODTCP-XC	●	●	●	●	●	○	●	●	●	●	●	●	●	●	●
CI541-DP	●	●	●	●	●	●	●	●	●	●	●	●	●	●	○
CI541-DP-XC	●	●	●	●	●	●	●	●	●	●	●	●	●	●	○
CI542-DP	●	●	●	●	●	●	●	●	●	●	●	●	●	●	○
CI542-DP-XC	●	●	●	●	●	●	●	●	●	●	●	●	●	●	○
CI581-CN	●	●	●	●	●	●	●	●	●	●	●	●	●	●	○
CI581-CN-XC	●	●	●	●	●	●	●	●	●	●	●	●	●	●	○
CI582-CN	●	●	●	●	●	●	●	●	●	●	●	●	●	●	○
CI582-CN-XC	●	●	●	●	●	●	●	●	●	●	●	●	●	●	○
CI590-CS31-HA	●	●	●	●	●	●	●	●	●	●	●	●	●	-	●
CI590-CS31-HA-XC	●	●	●	●	●	●	●	●	●	●	●	●	●	-	●
CI592-CS31	●	●	●	●	●	●	●	●	●	●	●	●	●	-	●
CI592-CS31-XC	●	●	●	●	●	●	●	●	●	●	●	●	●	-	●
CM5610-2RS	○	○	○	○	-	○	○	○	○	○	○	○	○	○	○
CM5610-2RS-XC	○	○	○	○	-	○	○	○	○	○	○	○	○	○	○
CM5640-2ETH	●	●	●	○	-	○	●	○	○	○	○	○	○	○	○
CM5640-2ETH-XC	●	●	●	○	-	○	●	○	○	○	○	○	○	○	○
CM574-RCOM	●	●	●	●	●	●	●	●	-	-	-	-	-	-	-
CM574-RS	●	●	●	●	●	●	●	●	●	●	●	●	●	●	-
CM579-ETHCAT	●	●	●	●	●	●	●	●	●	●	●	●	●	-	-
CM579-PNIO	●	●	●	●	●	●	●	●	●	●	●	●	●	●	○
CM579-PNIO-XC	●	●	●	●	●	●	●	●	●	●	●	●	●	●	○
CM582-DP	●	●	●	○	●	○	●	●	○	○	○	○	○	●	○
CM582-DP-XC	●	●	●	○	●	○	●	●	○	○	○	○	○	●	○
CM588-CN	●	●	●	●	●	●	●	●	●	●	●	●	●	●	○
CM588-CN-XC	●	●	●	●	●	●	●	●	●	●	●	●	●	●	○
CM589-PNIO	●	●	●	○	●	○	●	●	○	●	●	●	●	●	○
CM589-PNIO-4	●	●	●	○	●	○	●	●	○	●	●	●	●	●	○
CM589-PNIO-4-XC	●	●	●	○	●	○	●	●	○	●	●	●	●	●	○
CM589-PNIO-XC	●	●	●	○	●	○	●	●	○	●	●	●	●	●	○
CM592-DP	●	●	●	○	●	○	●	●	○	●	●	●	●	●	○
CM592-DP-XC	●	●	●	○	●	○	●	●	○	●	●	●	●	●	○
CM597-ETH	●	●	●	●	●	○	●	●	○	●	●	●	●	●	●
CM597-ETH-XC	●	●	●	●	●	○	●	●	○	●	●	●	●	●	●
CM598-CN	●	●	●	○	●	○	●	●	○	●	●	●	●	●	○
CM598-CN-XC	●	●	●	○	●	○	●	●	○	●	●	●	●	●	○
CP604	●	●	●	○	●	○	●	-	-	-	●	-	-	-	-
CP604-B	●	●	●	○	●	○	●	-	-	-	●	-	-	-	-
CP607	●	●	●	○	●	○	●	-	-	-	●	-	-	-	-
CP607-B	●	●	●	○	●	○	●	-	-	-	●	-	-	-	-
CP610	●	●	●	○	●	○	●	-	-	-	●	-	-	-	-
CP610-B	●	●	●	○	●	○	●	-	-	-	●	-	-	-	-

Additional information

Certifications

Symbols and legends:

- Standard product certified: product label wears approval mark when mandatory
- ◐ Submitted (roadmap available upon request)
- Submission planned (roadmap available upon request)
- Submission not planned or not applicable for product

Name	Conformité Européenne	UKCA UK Conformity Assessed	SJ/T 11363-2006 (China RoHS)	Regulatory Compliance Mark (RCM)	Eurasian Conformity	Korea Certification	Underwriter Laboratories	American Bureau of Shipping	Bureau Veritas	DNV	Lloyds Register	RINA	Korean Register of Shipping	China Classification Society	
Logo / Certification Mark															
Certificate	Declaration of Conformity LVD / EMC	Declaration of Conformity	Declaration of Conformity	Declaration of Conformity	Declaration of Conformity	Declaration of Conformity	cULus Ordinary Locations	cULus Hazardous Locations	Design Assessment	Type Approval	Type Approval	Type Approval	Type Approval	Type Approval	
CP6407	●	●	●	○	–	○	●	●	–	–	●	–	–	●	●
CP6410	●	●	●	○	–	○	●	●	–	–	●	–	–	●	●
CP6415	●	●	●	○	–	○	●	●	–	–	●	–	–	●	●
CP6605	●	●	●	○	●	○	●	●	–	–	●	–	–	●	–
CP6607	●	●	●	○	●	○	●	●	–	–	●	–	–	●	–
CP6610	●	●	●	○	●	○	●	●	–	–	●	–	–	●	–
CP6615	●	●	●	○	●	○	●	●	–	–	●	–	–	●	–
CP6621	●	●	●	○	●	○	●	●	–	–	●	–	–	●	–
DA501	●	●	●	●	●	●	●	●	●	●	●	●	●	●	○
DA501-XC	●	●	●	●	●	●	●	●	●	●	●	●	●	●	○
DA502	●	●	●	○	●	○	●	●	●	○	○	●	●	●	○
DA502-XC	●	●	●	○	●	○	●	●	●	○	○	●	●	●	○
DC522	●	●	●	●	●	●	●	●	●	●	●	●	●	●	●
DC522-XC	●	●	●	●	●	●	●	●	●	●	●	●	●	●	●
DC523	●	●	●	●	●	●	●	●	●	●	●	●	●	●	●
DC523-XC	●	●	●	●	●	●	●	●	●	●	●	●	●	●	●
DC532	●	●	●	●	●	●	●	●	●	●	●	●	●	●	●
DC532-XC	●	●	●	●	●	●	●	●	●	●	●	●	●	●	●
DC541-CM	●	●	●	●	●	●	●	●	●	●	●	●	●	●	–
DC541-CM-XC	●	●	●	●	●	●	●	●	●	●	●	●	●	●	–
DC551-CS31	●	●	●	●	●	●	●	●	●	●	●	●	●	–	●
DC551-CS31-XC	●	●	●	●	●	●	●	●	●	●	●	●	●	–	●
DC562	●	●	●	●	●	○	●	●	●	○	●	●	●	●	–
DI524	●	●	●	●	●	●	●	●	●	●	●	●	●	●	●
DI524-XC	●	●	●	●	●	●	●	●	●	●	●	●	●	●	●
DI561	●	●	●	●	●	●	●	●	●	●	●	●	●	●	–
DI562	●	●	●	●	●	●	●	●	●	●	●	●	●	●	–
DI571	●	●	●	●	●	●	●	●	●	●	●	●	●	●	–
DI572	●	●	●	●	●	○	●	●	●	○	●	●	●	●	–
DI581-S	●	●	●	●	●	●	●	●	●	●	●	●	●	●	○
DI581-S-XC	●	●	●	●	●	○	●	●	●	●	●	●	●	●	○
DM-KEY	●	●	●	–	–	–	–	–	–	–	–	–	–	–	–
DO524	●	●	●	○	●	○	●	●	●	●	●	●	●	●	●
DO524-XC	●	●	●	○	●	○	●	●	●	●	●	●	●	●	●
DO526	●	●	●	○	●	○	●	●	●	●	●	●	●	●	○
DO526-XC	●	●	●	○	●	○	●	●	●	●	●	●	●	●	○
DO561	●	●	●	●	●	●	●	●	●	●	●	●	●	●	–
DO562	●	●	●	●	●	○	●	●	●	○	●	●	●	●	–
DO571	●	●	●	●	●	●	●	●	●	●	●	●	●	●	–

Symbols and legends:

- Standard product certified: product label wears approval mark when mandatory
- Submitted (roadmap available upon request)
- Submission planned (roadmap available upon request)
- Submission not planned or not applicable for product

Name	Conformité Européenne	UKCA UK Conformity Assessed	SJ/T 11363-2006 (China RoHS)	Regulatory Compliance Mark (RCM)	Eurasian Conformity	Korea Certification	Underwriter Laboratories	American Bureau of Shipping	Bureau Veritas	DNV	Lloyds Register	RINA	Korean Register of Shipping	China Classification Society	
Logo / Certification Mark															
Certificate	Declaration of Conformity LVD / EMC	Declaration of Conformity	Declaration of Conformity	Declaration of Conformity	Declaration of Conformity	Declaration of Conformity	cULus Ordinary Locations	cULus Hazardous Locations	Design Assessment	Type Approval	Type Approval	Type Approval	Type Approval	Type Approval	Type Approval
DO572	●	●	●	●	●	●	●	●	●	●	●	●	●	●	-
DO573	●	●	●	●	●	○	●	●	●	○	●	●	●	●	-
DX522	●	●	●	●	●	●	●	●	●	●	●	●	●	●	○
DX522-XC	●	●	●	●	●	●	●	●	●	●	●	●	●	●	○
DX531	●	●	●	●	●	●	●	●	●	●	●	●	●	●	○
DX561	●	●	●	●	●	●	●	●	●	●	●	●	●	●	-
DX571	●	●	●	●	●	●	●	●	●	●	●	●	●	●	-
DX581-S	●	●	●	●	●	●	●	●	●	●	●	●	●	●	○
DX581-S-XC	●	●	●	●	●	○	●	●	●	●	●	●	●	●	○
FM502-CMS	●	●	●	○	●	●	●	●	●	○	●	●	●	●	○
FM502-CMS-XC	●	●	●	○	●	●	●	●	●	○	●	●	●	●	○
FM562	●	●	●	●	●	○	●	●	●	○	●	●	●	●	-
MC5102	●	●	●	○	-	○	-	-	●	●	●	●	●	●	○
MC5141	●	●	●	○	-	○	-	-	○	○	○	○	○	○	○
PD501-4CH	●	●	●	●	-	●	●	-	●	●	●	●	●	-	-
PM5012-R-ETH	●	●	●	○	-	○	●	●	●	●	●	●	●	●	○
PM5012-T-ETH	●	●	●	○	-	○	●	●	●	●	●	●	●	●	○
PM5032-R-ETH	●	●	●	○	-	○	●	●	●	●	●	●	●	●	○
PM5032-T-ETH	●	●	●	○	-	○	●	●	●	●	●	●	●	●	○
PM5052-R-ETH	●	●	●	○	-	○	●	●	●	●	●	●	●	●	○
PM5052-T-ETH	●	●	●	○	-	○	●	●	●	●	●	●	●	●	○
PM5072-T-2ETH	●	●	●	○	-	○	●	●	●	●	●	●	●	●	○
PM5072-T-2ETHW	●	●	●	○	-	○	●	●	●	●	●	●	●	●	○
PM5630-2ETH	●	●	●	○	●	○	●	●	●	●	●	●	●	●	●
PM5630-2ETH-XC	●	●	●	○	●	○	●	●	●	●	●	●	●	●	●
PM5650-2ETH	●	●	●	○	●	○	●	●	●	●	●	●	●	●	●
PM5650-2ETH-XC	●	●	●	○	●	○	●	●	●	●	●	●	●	●	●
PM5670-2ETH	●	●	●	○	●	○	●	●	●	●	●	●	●	●	●
PM5670-2ETH-XC	●	●	●	○	●	○	●	●	●	●	●	●	●	●	●
PM5675-2ETH	●	●	●	○	●	○	●	●	●	●	●	●	●	●	●
PM5675-2ETH-XC	●	●	●	○	●	○	●	●	●	●	●	●	●	●	●
PM573-ETH	●	●	●	●	●	●	●	●	●	●	●	●	●	●	●
PM573-ETH-XC	●	●	●	●	●	●	●	●	●	●	●	●	●	●	●
PM582	●	●	●	●	●	●	●	●	●	●	●	●	●	●	●
PM582-XC	●	●	●	●	●	●	●	●	●	●	●	●	●	●	●
PM583-ETH	●	●	●	●	●	●	●	●	●	●	●	●	●	●	●
PM583-ETH-XC	●	●	●	●	●	●	●	●	●	●	●	●	●	●	●
PM585-ETH	●	●	●	○	●	○	●	○	●	●	●	●	●	●	●
PM590-ARCNET	●	●	●	●	●	●	●	●	●	-	-	●	-	-	-
PM590-ETH	●	●	●	●	●	●	●	●	●	●	●	●	●	●	●
PM591-2ETH	●	●	●	●	●	○	●	-	●	○	●	●	●	●	●
PM591-ETH	●	●	●	●	●	●	●	●	●	●	●	●	●	●	●
PM591-ETH-XC	●	●	●	●	●	●	●	●	●	●	●	●	●	●	●
PM592-ETH	●	●	●	●	●	●	●	●	●	●	●	●	●	●	●
PM592-ETH-XC	●	●	●	●	●	●	●	●	●	●	●	●	●	●	●
PM595-4ETH-F	●	●	●	○	●	○	●	●	●	○	●	●	●	●	-
PM595-4ETH-M-XC	●	●	●	○	●	○	●	●	●	○	●	●	●	●	-

Additional information

Certifications

Symbols and legends:

- Standard product certified: product label wears approval mark when mandatory
- ◐ Submitted (roadmap available upon request)
- Submission planned (roadmap available upon request)
- Submission not planned or not applicable for product

Name	Conformité Européenne	UKCA UK Conformity Assessed	SJ/T 11363-2006 (China RoHS)	Regulatory Compliance Mark (RCM)	Eurasian Conformity	Korea Certification	Underwriter Laboratories	American Bureau of Shipping	Bureau Veritas	DNV	Lloyds Register	RINA	Korean Register of Shipping	China Classification Society
Logo / Certification Mark														
Certificate	Declaration of Conformity LVD / EMC	Declaration of Conformity	Declaration of Conformity	Declaration of Conformity	Declaration of Conformity	Declaration of Conformity	cULus Ordinary Locations	cULus Hazardous Locations	Design Assessment	Type Approval	Type Approval	Type Approval	Type Approval	Type Approval
SM560-S	●	●	●	●	●	●	●	●	●	●	●	●	●	○
SM560-S-FD-1	●	●	●	○	●	○	●	●	●	●	●	●	●	○
SM560-S-FD-1-XC	●	●	●	○	●	○	●	●	●	●	●	●	●	○
SM560-S-FD-4	●	●	●	○	●	○	●	●	●	●	●	●	●	○
SM560-S-FD-4-XC	●	●	●	○	●	○	●	●	●	●	●	●	●	○
SM560-S-XC	●	●	●	●	●	○	●	●	●	●	●	●	●	○
TA5101-4DI	●	●	●	○	–	○	●	●	●	●	●	●	●	○
TA5101-4DIW	○	○	○	○	–	○	○	○	○	○	○	○	○	○
TA5105-4DOT	●	●	●	○	–	○	●	●	●	●	●	●	●	○
TA5105-4DOTW	○	○	○	○	–	○	○	○	○	○	○	○	○	○
TA5110-2DI2DOT	●	●	●	○	–	○	●	●	●	●	●	●	●	○
TA5110-2DI2DOW	○	○	○	○	–	○	○	○	○	○	○	○	○	○
TA5120-2AI-UI	●	●	●	○	–	○	●	●	○	○	○	○	○	○
TA5120-2AI-UIW	○	○	○	○	–	○	○	○	○	○	○	○	○	○
TA5122-2AI-TC	○	○	○	○	–	○	○	○	○	○	○	○	○	○
TA5122-2AI-TCW	○	○	○	○	–	○	○	○	○	○	○	○	○	○
TA5123-2AI-RTD	○	○	○	○	–	○	○	○	○	○	○	○	○	○
TA5123-2AI-RTW	○	○	○	○	–	○	○	○	○	○	○	○	○	○
TA5126-2AO-UI	●	●	●	○	–	○	●	●	○	○	○	○	○	○
TA5126-2AO-UIW	○	○	○	○	–	○	○	○	○	○	○	○	○	○
TA5128-2AI1AO	○	○	○	○	–	○	○	○	○	○	○	○	○	○
TA5130-KNXPB	●	●	●	○	–	○	●	●	●	●	●	●	●	○
TA5130-KNXPBW	○	○	○	○	–	○	○	○	○	○	○	○	○	○
TA5131-RTC	●	●	●	○	–	○	●	●	●	●	●	●	●	○
TA5141-RS232I	●	●	●	○	–	○	●	●	●	●	●	●	●	○
TA5141-RS232IW	○	○	○	○	–	○	○	○	○	○	○	○	○	○
TA5142-RS485	●	●	●	○	–	○	●	●	●	●	●	●	●	○
TA5142-RS485I	●	●	●	○	–	○	●	●	●	●	●	●	●	○
TA5142-RS485IW	○	○	○	○	–	○	○	○	○	○	○	○	○	○
TA5142-RS485W	○	○	○	○	–	○	○	○	○	○	○	○	○	○
TA515-CASE	●	●	●	○	–	○	–	–	–	–	–	–	–	–
TA521	–	–	●	–	●	–	●	–	●	○	●	–	●	●
TA5211-TSCL-B	●	●	●	○	–	○	–	–	●	●	●	●	●	○
TA5211-TSPF-B	●	●	●	○	–	○	–	–	●	●	●	●	●	○
TA5212-TSCL	●	●	●	○	–	○	–	–	●	●	●	●	●	○
TA5212-TSPF	●	●	●	○	–	○	–	–	●	●	●	●	●	○
TA5220-SPF5	●	●	●	○	–	○	–	–	●	●	●	●	●	○
TA5220-SPF6	●	●	●	○	–	○	–	–	●	●	●	●	●	○
TA5220-SPF7	●	●	●	○	–	○	–	–	●	●	●	●	●	○

Symbols and legends:

- Standard product certified: product label wears approval mark when mandatory
- Submitted (roadmap available upon request)
- Submission planned (roadmap available upon request)
- Submission not planned or not applicable for product

Name	Conformité Européenne	UKCA UK Conformity Assessed	SJ/T 11363-2006 (China RoHS)	Regulatory Compliance Mark (RCM)	Eurasian Conformity	Korea Certification	Underwriter Laboratories	American Bureau of Shipping	Bureau Veritas	DNV	Lloyds Register	RINA	Korean Register of Shipping	China Classification Society
Logo / Certification Mark														
Certificate	Declaration of Conformity LVD / EMC	Declaration of Conformity	Declaration of Conformity	Declaration of Conformity	Declaration of Conformity	Declaration of Conformity	cULus Ordinary Locations	cULus Hazardous Locations	Design Assessment	Type Approval	Type Approval	Type Approval	Type Approval	Type Approval
TA5220-SPF8	●	●	●	○	-	○	-	-	●	●	●	●	●	-
TA523	●	●	●	-	-	-	●	-	●	-	-	-	●	○
TA524	●	●	●	-	●	-	●	-	●	●	●	-	●	○
TA525	●	●	●	-	-	-	●	-	●	-	-	-	●	-
TA526	●	●	●	-	-	-	●	-	●	○	●	-	●	○
TA527	●	●	●	-	●	-	-	-	-	-	-	-	-	-
TA528	●	●	●	-	●	-	-	-	-	-	-	-	-	-
TA5300-CVR	●	●	●	○	-	○	-	-	●	●	●	●	●	○
TA5301-CFA	●	●	●	○	-	○	-	-	●	●	●	●	●	○
TA532	●	●	●	-	●	-	-	-	-	-	-	-	-	-
TA533	●	●	●	-	●	-	-	-	-	-	-	-	-	-
TA534	●	●	●	-	●	-	-	-	-	-	-	-	-	-
TA535	●	●	●	-	-	-	-	-	-	-	-	-	-	-
TA5350-AD	●	●	●	○	-	○	-	-	-	-	-	-	-	-
TA536	●	●	●	-	●	-	-	-	-	-	-	-	-	-
TA540	●	●	●	-	-	-	-	-	-	-	-	-	-	-
TA5400-SIM	●	●	●	-	-	-	-	-	-	-	-	-	-	-
TA541	-	-	●	-	●	-	-	-	-	-	-	-	●	-
TA543	●	●	●	-	-	-	-	-	-	-	-	-	-	-
TA5450-CASE	●	●	●	-	-	-	-	-	-	-	-	-	-	-
TA563-11	●	●	●	-	●	-	-	-	●	●	●	●	●	-
TA563-9	●	●	●	-	●	-	-	-	●	●	●	●	●	-
TA564-11	●	●	●	-	●	-	-	-	●	●	●	●	●	-
TA564-9	●	●	●	-	●	-	-	-	●	●	●	●	●	-
TA565-11	●	●	●	-	●	-	-	-	●	●	●	●	●	-
TA565-9	●	●	●	-	●	-	-	-	●	●	●	●	●	-
TB511-ARCNET	●	●	●	●	●	●	●	●	●	●	●	●	●	-
TB511-ETH	●	●	●	●	●	●	●	●	●	●	●	●	●	●
TB511-ETH-XC	●	●	●	●	●	●	●	●	●	●	●	●	●	●
TB521-ARCNET	●	●	●	●	●	●	●	●	●	●	●	●	●	-
TB521-ETH	●	●	●	●	●	●	●	●	●	●	●	●	●	●
TB521-ETH-XC	●	●	●	●	●	●	●	●	●	●	●	●	●	●
TB523-2ETH	●	●	●	●	●	○	●	-	●	○	●	●	●	●
TB541-ETH	●	●	●	●	●	○	●	●	●	●	●	●	●	●
TB541-ETH-XC	●	●	●	●	●	○	●	●	●	●	●	●	●	●
TB5600-2ETH	●	●	●	○	●	○	●	●	●	●	●	●	●	●
TB5600-2ETH-XC	●	●	●	○	●	○	●	●	●	●	●	●	●	●
TB5610-2ETH	●	●	●	○	●	○	●	●	●	●	●	●	●	●
TB5610-2ETH-XC	●	●	●	○	●	○	●	●	●	●	●	●	●	●
TB5620-2ETH	●	●	●	○	●	○	●	●	●	●	●	●	●	●
TB5620-2ETH-XC	●	●	●	○	●	○	●	●	●	●	●	●	●	●
TB5640-2ETH	●	●	●	○	●	○	●	●	○	○	●	○	○	●
TB5640-2ETH-XC	●	●	●	○	●	○	●	●	○	○	●	○	○	●
TB5660-2ETH	●	●	●	○	●	○	●	●	○	○	●	○	○	●
TB5660-2ETH-XC	●	●	●	○	●	○	●	●	○	○	●	○	○	●
TF501-CMS	●	●	●	○	●	○	●	●	●	○	●	●	●	○
TF501-CMS-XC	●	●	●	○	●	○	●	●	●	○	●	●	●	○

Additional information

Certifications

Symbols and legends:

- Standard product certified: product label wears approval mark when mandatory
- ◐ Submitted (roadmap available upon request)
- Submission planned (roadmap available upon request)
- Submission not planned or not applicable for product

Name	Conformité Européenne	UKCA UK Conformity Assessed	SJ/T 11363-2006 (China RoHS)	Regulatory Compliance Mark (RCM)	Eurasian Conformity	Korea Certification	Underwriter Laboratories	American Bureau of Shipping	Bureau Veritas	DNV	Lloyds Register	RINA	Korean Register of Shipping	China Classification Society
Logo / Certification Mark														
Certificate	Declaration of Conformity LVD / EMC	Declaration of Conformity	Declaration of Conformity	Declaration of Conformity	Declaration of Conformity	Declaration of Conformity	cULus Ordinary Locations	cULus Hazardous Locations	Design Assessment	Type Approval	Type Approval	Type Approval	Type Approval	Type Approval
TF521-CMS	●	●	●	○	●	○	●	●	●	○	●	●	●	○
TF521-CMS-XC	●	●	●	○	●	○	●	●	●	○	●	●	●	○
TK6028	●	●	●	–	–	–	–	–	–	–	–	–	–	–
TK6031	●	●	●	–	–	–	–	–	–	–	–	–	–	–
TU507-ETH	●	●	●	●	●	●	●	●	●	●	●	●	●	●
TU508-ETH	●	●	●	●	●	●	●	●	●	●	●	●	●	●
TU508-ETH-XC	●	●	●	●	●	●	●	●	●	●	●	●	●	●
TU509	●	●	●	●	●	●	●	●	●	●	●	●	●	○
TU510	●	●	●	●	●	●	●	●	●	●	●	●	●	○
TU510-XC	●	●	●	●	●	●	●	●	●	●	●	●	●	○
TU515	●	●	●	●	●	●	●	●	●	●	●	●	●	●
TU516	●	●	●	●	●	●	●	●	●	●	●	●	●	●
TU516-H	●	●	●	○	●	○	●	●	○	○	○	○	–	○
TU516-H-XC	●	●	●	○	●	○	●	●	○	○	○	○	–	○
TU516-XC	●	●	●	●	●	●	●	●	●	●	●	●	●	●
TU517	●	●	●	●	●	●	●	●	●	●	●	●	●	○
TU518	●	●	●	●	●	●	●	●	●	●	●	●	●	○
TU518-XC	●	●	●	●	●	●	●	●	●	●	●	●	●	○
TU520-ETH	●	●	●	●	●	●	●	●	●	●	●	●	●	○
TU520-ETH-XC	●	●	●	●	●	●	●	●	●	●	●	●	●	○
TU531	●	●	●	●	●	●	●	●	●	●	●	●	●	○
TU532	●	●	●	●	●	●	●	●	●	●	●	●	●	○
TU532-H	●	●	●	○	●	○	●	●	○	○	○	○	–	○
TU532-H-XC	●	●	●	○	●	○	●	●	○	○	○	○	–	○
TU532-XC	●	●	●	●	●	●	●	●	●	●	●	●	●	○
TU541	●	●	●	○	–	●	●	○	●	●	●	●	●	○
TU542	●	●	●	●	●	●	●	–	●	●	●	●	●	○
TU542-H	●	●	●	○	●	○	●	●	○	○	○	○	–	○
TU542-H-XC	●	●	●	○	●	○	●	●	○	○	○	○	–	○
TU542-XC	●	●	●	○	●	○	●	–	●	●	●	●	●	○
TU551-CS31	●	●	●	●	●	●	●	●	●	●	●	●	–	●
TU552-CS31	●	●	●	●	●	●	●	●	●	●	●	●	–	●
TU552-CS31-XC	●	●	●	●	●	●	●	●	●	●	●	●	–	●
TU582-S	●	●	●	●	●	○	●	●	●	●	●	●	●	○
TU582-S-XC	●	●	●	●	●	○	●	●	●	●	●	●	●	○

Index

Order code classification

Order code	Product type	Product range	Page
1SAP110300R0278	TB5600-2ETH	AC500	150
1SAP111100R0260	TB511-ARCNET	AC500	146
1SAP111100R0270	TB511-ETH	AC500	146
1SAP111300R0278	TB5610-2ETH	AC500	150
1SAP112100R0260	TB521-ARCNET	AC500	146
1SAP112100R0270	TB521-ETH	AC500	146
1SAP112300R0277	TB523-2ETH	AC500	146
1SAP112300R0278	TB5620-2ETH	AC500	150
1SAP114100R0270	TB541-ETH	AC500	146
1SAP114300R0278	TB5640-2ETH	AC500	150
1SAP116300R0278	TB5660-2ETH	AC500	150
1SAP117000R0271	TF501-CMS	AC500	147
1SAP117200R0271	TF521-CMS	AC500	147
1SAP122600R0072	PM5012-T-ETH	AC500-eCo	118
1SAP122700R0072	PM5012-R-ETH	AC500-eCo	118
1SAP123400R0072	PM5032-T-ETH	AC500-eCo	118
1SAP123500R0072	PM5032-R-ETH	AC500-eCo	118
1SAP124000R0072	PM5052-T-ETH	AC500-eCo	118
1SAP124100R0072	PM5052-R-ETH	AC500-eCo	118
1SAP124400R0073	PM5072-T-2ETHW	AC500-eCo	118
1SAP124500R0073	PM5072-T-2ETH	AC500-eCo	118
1SAP130300R0271	PM573-ETH	AC500	144
1SAP131000R0278	PM5630-2ETH	AC500	148
1SAP131000R0379	PM5630-MC-KIT	AC500	148
1SAP140200R0201	PM582	AC500	144
1SAP140300R0271	PM583-ETH	AC500	144
1SAP140500R0271	PM585-ETH	AC500	144
1SAP140500R0379	PM585-MC-KIT	AC500	144
1SAP141000R0278	PM5650-2ETH	AC500	148
1SAP141000R0379	PM5650-MC-KIT	AC500	148
1SAP150000R0261	PM590-ARCNET	AC500	144
1SAP150000R0271	PM590-ETH	AC500	144
1SAP150000R0379	PM590-MC-KIT	AC500	144
1SAP150100R0271	PM591-ETH	AC500	144
1SAP150100R0277	PM591-2ETH	AC500	144
1SAP150200R0271	PM592-ETH	AC500	144
1SAP151000R0278	PM5670-2ETH	AC500	148
1SAP151000R0379	PM5670-MC-KIT	AC500	148
1SAP151500R0278	PM5675-2ETH	AC500	148
1SAP155500R0279	PM595-4ETH-F	AC500	145
1SAP170400R0201	CM574-RS	AC500	151
1SAP170401R0201	CM574-RCOM	AC500	151
1SAP170901R0101	CM579-PNIO	AC500	151
1SAP170902R0101	CM579-ETHCAT	AC500	151
1SAP172200R0001	CM582-DP	AC500	151
1SAP172800R0001	CM588-CN	AC500	151
1SAP172900R0011	CM589-PNIO	AC500	151
1SAP172900R0111	CM589-PNIO-4	AC500	151
1SAP173200R0001	CM592-DP	AC500	151
1SAP173700R0001	CM597-ETH	AC500	151
1SAP173800R0001	CM598-CN	AC500	151
1SAP176000R0020	CM5610-2RS	AC500	151
1SAP176000R0080	CM5640-2ETH	AC500	151
1SAP180100R0002	MC5102	AC500-eCo	120
1SAP180100R0002	MC5102	AC500	158
1SAP180100R0041	MC5141	AC500	158
1SAP180100R0041	MC5141	AC500-XC	208

Order code	Product type	Product range	Page
1SAP180300R0001	TA521	AC500	158
1SAP180300R0001	TA521	AC500-XC	208
1SAP180500R0001	TA523	AC500	158
1SAP180500R0001	TA523	AC500-XC	208
1SAP180600R0001	TA524	AC500	158
1SAP180600R0001	TA524	AC500-XC	208
1SAP180700R0001	TA525	AC500	158
1SAP180700R0001	TA525	AC500-XC	208
1SAP180800R0001	TA526	AC500	158
1SAP180800R0001	TA526	AC500-XC	208
1SAP181100R0001	TA527	AC500	158
1SAP181100R0001	TA527	AC500-XC	208
1SAP181200R0001	TA528	AC500	158
1SAP181200R0001	TA528	AC500-XC	208
1SAP182000R0001	TA532	AC500	158
1SAP182000R0001	TA532	AC500-XC	208
1SAP182100R0001	TA533	AC500	158
1SAP182100R0001	TA533	AC500-XC	208
1SAP182200R0001	TA534	AC500	158
1SAP182200R0001	TA534	AC500-XC	208
1SAP182300R0001	TA535	AC500-XC	208
1SAP182400R0002	TA515-CASE	AC500	158
1SAP182400R0002	TA515-CASE	AC500	270
1SAP182600R0001	TA540	AC500	158
1SAP182600R0001	TA540	AC500-XC	208
1SAP182700R0001	TA541	AC500	158
1SAP182700R0001	TA541	AC500-XC	208
1SAP182800R0001	TA543	AC500-eCo	120
1SAP182800R0001	TA543	AC500	158
1SAP182800R0001	TA543	AC500-XC	208
1SAP182900R0001	TA514-SAFETY	AC500-S	244
1SAP182900R0001	TA514-SAFETY	AC500-S	270
1SAP183100R0001	TA536	AC500	158
1SAP183100R0001	TA536	AC500-XC	208
1SAP187000R0001	TA5101-4DI	AC500-eCo	121
1SAP187000R0002	TA5105-4DOT	AC500-eCo	121
1SAP187000R0003	TA5110-2DI2DOT	AC500-eCo	121
1SAP187000R0201	TA5101-4DIW	AC500-eCo	121
1SAP187000R0202	TA5105-4DOTW	AC500-eCo	121
1SAP187000R0203	TA5110-2DI2DOW	AC500-eCo	121
1SAP187100R0001	TA5120-2AI-UI	AC500-eCo	121
1SAP187100R0002	TA5123-2AI-RTD	AC500-eCo	121
1SAP187100R0003	TA5126-2AO-UI	AC500-eCo	121
1SAP187100R0004	TA5122-2AI-TC	AC500-eCo	121
1SAP187100R0201	TA5120-2AI-UIW	AC500-eCo	121
1SAP187100R0202	TA5123-2AI-RTW	AC500-eCo	121
1SAP187100R0203	TA5126-2AO-UIW	AC500-eCo	121
1SAP187100R0204	TA5122-2AI-TCW	AC500-eCo	121
1SAP187200R0001	TA5130-KNXPB	AC500-eCo	122
1SAP187200R0002	TA5131-RTC	AC500-eCo	120
1SAP187200R0002	TA5131-RTC	AC500-eCo	122
1SAP187200R0201	TA5130-KNXPBW	AC500-eCo	122
1SAP187300R0001	TA5141-RS232I	AC500-eCo	122
1SAP187300R0002	TA5142-RS485I	AC500-eCo	122
1SAP187300R0003	TA5142-RS485	AC500-eCo	122
1SAP187300R0201	TA5141-RS232W	AC500-eCo	122
1SAP187300R0202	TA5142-RS485IW	AC500-eCo	122

Index

Order code classification

Order code	Product type	Product range	Page
1SAP187300R0203	TA5142-RS485W	AC500-eCo	122
1SAP187400R0001	TA5211-TSCL-B	AC500-eCo	120
1SAP187400R0002	TA5211-TSPF-B	AC500-eCo	120
1SAP187400R0004	TA5212-TSCL	AC500-eCo	120
1SAP187400R0005	TA5212-TSPF	AC500-eCo	120
1SAP187400R0012	TA5220-SPF5	AC500-eCo	122
1SAP187400R0013	TA5220-SPF6	AC500-eCo	122
1SAP187400R0014	TA5220-SPF7	AC500-eCo	122
1SAP187400R0015	TA5220-SPF8	AC500-eCo	122
1SAP187500R0001	TA5300-CVR	AC500-eCo	120
1SAP187500R0003	TA5301-CFA	AC500-eCo	120
1SAP187600R0001	TA5400-SIM	AC500-eCo	120
1SAP187600R0002	TA5415-STAKIT	AC500-eCo	271
1SAP187600R0003	TA5426-STAKIT	AC500-eCo	271
1SAP187700R0001	TA5450-CASE	AC500	158
1SAP187700R0001	TA5450-CASE	AC500	270
1SAP192100R0102	PS552-MC-E	Automation Builder	103
1SAP192150R0101	PS5611-MC	Automation Builder	103
1SAP192150R0101	PS5611-MC	Automation Builder	119
1SAP192150R0101	PS5611-MC	Automation Builder	149
1SAP192150R0101	PS5611-MC	Automation Builder	200
1SAP193600R0001	DM-KEY	Automation Builder	102
1SAP195000R0101	PS562-SOLAR	Automation Builder	103
1SAP195002R0101	PS5609-Log	Automation Builder	103
1SAP195002R0101	PS5609-Log	Automation Builder	119
1SAP195002R0101	PS5609-Log	Automation Builder	149
1SAP195002R0101	PS5609-Log	Automation Builder	200
1SAP195004R0101	PS5609-Log-e	Automation Builder	103
1SAP195004R0101	PS5609-Log-e	Automation Builder	119
1SAP195004R0101	PS5609-Log-e	Automation Builder	149
1SAP195400R0101	PS5601-HA-MTCP	Automation Builder	103
1SAP195400R0101	PS5601-HA-MTCP	Automation Builder	119
1SAP195400R0101	PS5601-HA-MTCP	Automation Builder	149
1SAP195400R0101	PS5601-HA-MTCP	Automation Builder	200
1SAP195500R0101	PS565-BACnet-ASC	Automation Builder	103
1SAP195550R0101	PS5607-BACnet-BC	Automation Builder	103
1SAP195550R0101	PS5607-BACnet-BC	Automation Builder	119
1SAP195550R0101	PS5607-BACnet-BC	Automation Builder	149
1SAP195550R0101	PS5607-BACnet-BC	Automation Builder	200
1SAP195600R0101	PS5602-61850	Automation Builder	103
1SAP195600R0101	PS5602-61850	Automation Builder	119
1SAP195600R0101	PS5602-61850	Automation Builder	149
1SAP195600R0101	PS5602-61850	Automation Builder	200
1SAP195800R0101	PS5604-KNX	Automation Builder	103
1SAP195800R0101	PS5604-KNX	Automation Builder	119
1SAP195800R0101	PS5604-KNX	Automation Builder	149
1SAP195800R0101	PS5604-KNX	Automation Builder	200
1SAP196100R0101	PS5613-EIP-A	Automation Builder	103
1SAP196100R0101	PS5613-EIP-A	Automation Builder	119
1SAP196100R0101	PS5613-EIP-A	Automation Builder	149
1SAP196100R0101	PS5613-EIP-A	Automation Builder	200
1SAP196101R0101	PS5613-EIP-S	Automation Builder	103
1SAP196101R0101	PS5613-EIP-S	Automation Builder	119
1SAP196101R0101	PS5613-EIP-S	Automation Builder	149
1SAP196101R0101	PS5613-EIP-S	Automation Builder	200
1SAP196101R0101	PS5613-EIP-S	Automation Builder	200
1SAP196102R0101	PS5613-EIP-A-e	Automation Builder	103
1SAP196102R0101	PS5613-EIP-A-e	Automation Builder	119

Order code	Product type	Product range	Page
1SAP196102R0101	PS5613-EIP-A-e	Automation Builder	149
1SAP196103R0101	PS5613-EIP-S-e	Automation Builder	103
1SAP196103R0101	PS5613-EIP-S-e	Automation Builder	119
1SAP196103R0101	PS5613-EIP-S-e	Automation Builder	149
1SAP210400R0001	TU552-CS31	AC500	156
1SAP210600R0001	TU551-CS31	AC500	156
1SAP210800R0001	TU510	AC500	156
1SAP211000R0001	TU509	AC500	156
1SAP211200R0001	TU518	AC500	156
1SAP211400R0001	TU517	AC500	156
1SAP212000R0001	TU516	AC500	156
1SAP212200R0001	TU515	AC500	156
1SAP213000R0001	TU541	AC500	156
1SAP213200R0001	TU542	AC500	156
1SAP214000R0001	TU508-ETH	AC500	156
1SAP214200R0001	TU507-ETH	AC500	156
1SAP214400R0001	TU520-ETH	AC500	156
1SAP215000R0001	TU516-H	AC500	155
1SAP215100R0001	TU532-H	AC500	155
1SAP215200R0001	TU542-H	AC500	155
1SAP217000R0001	TU532	AC500	156
1SAP217200R0001	TU531	AC500	156
1SAP220500R0001	DC551-CS31	AC500	154
1SAP220600R0001	CI501-PNIO	AC500	154
1SAP220700R0001	CI502-PNIO	AC500	154
1SAP220900R0001	CI511-ETHCAT	AC500	154
1SAP221000R0001	CI512-ETHCAT	AC500	154
1SAP221100R0001	CI590-CS31-HA	AC500	154
1SAP221200R0001	CI592-CS31	AC500	154
1SAP221300R0001	CI504-PNIO	AC500	155
1SAP221500R0001	CI506-PNIO	AC500	155
1SAP222100R0001	CI521-MODTCP	AC500	154
1SAP222200R0001	CI522-MODTCP	AC500	154
1SAP224100R0001	CI541-DP	AC500	154
1SAP224200R0001	CI542-DP	AC500	154
1SAP228100R0001	CI581-CN	AC500	154
1SAP228200R0001	CI582-CN	AC500	154
1SAP230500R0000	DI572	AC500-eCo	123
1SAP230900R0000	DO562	AC500-eCo	123
1SAP231300R0000	DO573	AC500-eCo	123
1SAP231900R0000	DC562	AC500-eCo	123
1SAP233100R0001	FM562	AC500-eCo	124
1SAP240000R0001	DI524	AC500	152
1SAP240100R0001	DC532	AC500	152
1SAP240500R0001	DC523	AC500	152
1SAP240600R0001	DC522	AC500	152
1SAP240700R0001	DO524	AC500	152
1SAP240800R0001	DO526	AC500	152
1SAP245000R0001	DX531	AC500	152
1SAP245200R0001	DX522	AC500	152
1SAP250000R0001	AX522	AC500	153
1SAP250100R0001	AX521	AC500	153
1SAP250200R0001	AO523	AC500	153
1SAP250300R0001	AI523	AC500	153
1SAP250500R0001	AC522	AC500	153
1SAP250600R0001	AI531	AC500	153
1SAP250700R0001	DA501	AC500	153

Index

Order code classification

Order code	Product type	Product range	Page
1SAP250800R0001	DA502	AC500	153
1SAP260300R0001	CD522	AC500	153
1SAP260400R0001	FM502-CMS	AC500	147
1SAP270000R0001	DC541-CM	AC500	153
1SAP280000R0001	SM560-S	AC500-S	244
1SAP281200R0001	TU582-S	AC500-S	244
1SAP282000R0001	AI581-S	AC500-S	244
1SAP284000R0001	DI581-S	AC500-S	244
1SAP284100R0001	DX581-S	AC500-S	244
1SAP286000R0001	SM560-S-FD-1	AC500-S	244
1SAP286100R0001	SM560-S-FD-4	AC500-S	244
1SAP310300R0278	TB5600-2ETH-XC	AC500-XC	201
1SAP311100R0270	TB511-ETH-XC	AC500-XC	197
1SAP311300R0278	TB5610-2ETH-XC	AC500-XC	201
1SAP312100R0270	TB521-ETH-XC	AC500-XC	197
1SAP312300R0278	TB5620-2ETH-XC	AC500-XC	201
1SAP314100R0270	TB541-ETH-XC	AC500-XC	197
1SAP314300R0278	TB5640-2ETH-XC	AC500-XC	201
1SAP316300R0278	TB5660-2ETH-XC	AC500-XC	201
1SAP317000R0271	TF501-CMS-XC	AC500-XC	198
1SAP317200R0271	TF521-CMS-XC	AC500-XC	198
1SAP330300R0271	PM573-ETH-XC	AC500-XC	196
1SAP331000R0278	PM5630-2ETH-XC	AC500-XC	199
1SAP340200R0201	PM582-XC	AC500-XC	196
1SAP340300R0271	PM583-ETH-XC	AC500-XC	196
1SAP341000R0278	PM5650-2ETH-XC	AC500-XC	199
1SAP350100R0271	PM591-ETH-XC	AC500-XC	196
1SAP350200R0271	PM592-ETH-XC	AC500-XC	196
1SAP351000R0278	PM5670-2ETH-XC	AC500-XC	199
1SAP351500R0278	PM5675-2ETH-XC	AC500-XC	199
1SAP351500R0279	PM595-4ETH-M-XC	AC500-XC	196
1SAP370901R0101	CM579-PNIO-XC	AC500-XC	202
1SAP372200R0001	CM582-DP-XC	AC500-XC	202
1SAP372800R0001	CM588-CN-XC	AC500-XC	202
1SAP372900R0111	CM589-PNIO-XC	AC500-XC	202
1SAP372900R0111	CM589-PNIO-4-XC	AC500-XC	202
1SAP373200R0001	CM592-DP-XC	AC500-XC	202
1SAP373700R0001	CM597-ETH-XC	AC500-XC	202
1SAP373800R0001	CM598-CN-XC	AC500-XC	202
1SAP376000R0020	CM5610-2RS-XC	AC500-XC	202
1SAP376000R0080	CM5640-2ETH-XC	AC500-XC	202
1SAP380000R0001	SM560-S-XC	AC500-S	245
1SAP386000R0001	SM560-S-FD-1-XC	AC500-S	245
1SAP386100R0001	SM560-S-FD-4-XC	AC500-S	245
1SAP410400R0001	TU552-CS31-XC	AC500-XC	206
1SAP410800R0001	TU510-XC	AC500-XC	206
1SAP411200R0001	TU518-XC	AC500-XC	206
1SAP412000R0001	TU516-XC	AC500-XC	206
1SAP413200R0001	TU542-XC	AC500-XC	206
1SAP414000R0001	TU508-ETH-XC	AC500-XC	206
1SAP414400R0001	TU520-ETH-XC	AC500-XC	206
1SAP415000R0001	TU516-H-XC	AC500-XC	206
1SAP415100R0001	TU532-H-XC	AC500-XC	206
1SAP415200R0001	TU542-H-XC	AC500-XC	206
1SAP417000R0001	TU532-XC	AC500-XC	206
1SAP420500R0001	DC551-CS31-XC	AC500-XC	205
1SAP420600R0001	CI501-PNIO-XC	AC500-XC	205

Order code	Product type	Product range	Page
1SAP420700R0001	CI502-PNIO-XC	AC500-XC	205
1SAP421100R0001	CI590-CS31-HA-XC	AC500-XC	205
1SAP421200R0001	CI592-CS31-XC	AC500-XC	205
1SAP421300R0001	CI504-PNIO-XC	AC500-XC	205
1SAP421500R0001	CI506-PNIO-XC	AC500-XC	205
1SAP422100R0001	CI521-MODTCP-XC	AC500-XC	205
1SAP422200R0001	CI522-MODTCP-XC	AC500-XC	205
1SAP424100R0001	CI541-DP-XC	AC500-XC	205
1SAP424200R0001	CI542-DP-XC	AC500-XC	205
1SAP428100R0001	CI581-CN-XC	AC500-XC	205
1SAP428200R0001	CI582-CN-XC	AC500-XC	205
1SAP440000R0001	DI524-XC	AC500-XC	203
1SAP440100R0001	DC532-XC	AC500-XC	203
1SAP440500R0001	DC523-XC	AC500-XC	203
1SAP440600R0001	DC522-XC	AC500-XC	203
1SAP440700R0001	DO524-XC	AC500-XC	203
1SAP440800R0001	DO526-XC	AC500-XC	203
1SAP445200R0001	DX522-XC	AC500-XC	203
1SAP450000R0001	AX522-XC	AC500-XC	204
1SAP450100R0001	AX521-XC	AC500-XC	204
1SAP450200R0001	AO523-XC	AC500-XC	204
1SAP450300R0001	AI523-XC	AC500-XC	204
1SAP450500R0001	AC522-XC	AC500-XC	204
1SAP450600R0001	AI531-XC	AC500-XC	204
1SAP450700R0001	DA501-XC	AC500-XC	204
1SAP450800R0001	DA502-XC	AC500-XC	204
1SAP460300R0001	CD522-XC	AC500-XC	204
1SAP460400R0001	FM502-CMS-XC	AC500-XC	198
1SAP470000R0001	DC541-CM-XC	AC500-XC	204
1SAP481200R0001	TU582-S-XC	AC500-S	245
1SAP482000R0001	AI581-S-XC	AC500-S	245
1SAP484000R0001	DI581-S-XC	AC500-S	245
1SAP484100R0001	DX581-S-XC	AC500-S	245
1SAP500900R0101	PB610	Automation Builder	259
1SAP500901R0101	PB610-R	Automation Builder	259
1SAP500981R0001	TK681	CP600-eCo, CP600	259
1SAP500982R0001	TK682	CP600-eCo, CP600	259
1SAP504100R0001	CP604	CP600-eCo	258
1SAP504100R2001	CP604-B	CP600-eCo	258
1SAP506028R0001	TK6028	CP600-Pro	259
1SAP506031R0001	TK6031	CP600-eCo, CP600	259
1SAP507100R0001	CP607	CP600-eCo	258
1SAP507100R2001	CP607-B	CP600-eCo	258
1SAP510100R0001	CP610	CP600-eCo	258
1SAP510100R2001	CP610-B	CP600-eCo	258
1SAP540710R0001	CP6407	CP600	258
1SAP541010R0001	CP6410	CP600	258
1SAP541510R0001	CP6415	CP600	258
1SAP560510R0001	CP6605	CP600-Pro	259
1SAP560710R0001	CP6607	CP600-Pro	259
1SAP561010R0001	CP6610	CP600-Pro	259
1SAP561510R0001	CP6615	CP600-Pro	259
1SAP562110R0001	CP6621	CP600-Pro	259
1SAP800000R0010	07AC91-AD	AC500/AC31 adapter	276
1SAP800100R0010	07AC91-AD2	AC500/AC31 adapter	276
1SAP800200R0010	07AI91-AD	AC500/AC31 adapter	276
1SAP800300R0010	07DC91-AD	AC500/AC31 adapter	276

Index

Order code classification

Order code	Product type	Product range	Page
1SAP800500R0010	07DC92-AD	AC500/AC31 adapter	276
1SAP801100R0062	07KT98-ARC-DP-AD	AC500/AC31 adapter	276
1SAP801200R0062	07KT98-ARC-ETH-AD	AC500/AC31 adapter	276
1SAP801300R0072	07KT98-ETH-DP-AD	AC500/AC31 adapter	276
1SAP801400R0060	07KT98-ARC-AD	AC500/AC31 adapter	276
1SAP801500R0062	07KT98-ARC-ETH-DP-AD	AC500/AC31 adapter	276
1SAS010000R0102	DM200-TOOL	Automation Builder	102
1SAS010002R0102	DM202-PREM	Automation Builder	102
1SAS010004R0102	DM204-TOOL-NW	Automation Builder	102
1SAS010007R0102	DM207-PVC	Automation Builder	102
1SAS010010R0102	DM210-PSA	Automation Builder	102
1SAS010014R0102	DM214-PVC-NW	Automation Builder	102
1SAS010017R0102	DM217-PSA-NW	Automation Builder	102
1SAS010020R0102	DM220-FSE	Automation Builder	102
1SAS010021R0102	DM221-FSE-NW	Automation Builder	102
1SAS010050R0102	DM250-VCP	Automation Builder	102
1SAS010051R0102	DM251-VCP-NW	Automation Builder	102
1SAS030000R0101	PS563-WATER	Automation Builder	103
1SAS030010R0101	PS564-TEMPCTRL	Automation Builder	103
1TNE968901R3101	TA563-9	AC500-eCo	124
1TNE968901R3102	TA563-11	AC500-eCo	124
1TNE968901R3103	TA564-9	AC500-eCo	124
1TNE968901R3104	TA564-11	AC500-eCo	124
1TNE968901R3105	TA565-9	AC500-eCo	124
1TNE968901R3106	TA565-11	AC500-eCo	124
1TNE968902R1101	AI561	AC500-eCo	123
1TNE968902R1102	AI562	AC500-eCo	123
1TNE968902R1103	AI563	AC500-eCo	123
1TNE968902R1201	AO561	AC500-eCo	123
1TNE968902R1301	AX561	AC500-eCo	123
1TNE968902R2101	DI561	AC500-eCo	123
1TNE968902R2102	DI562	AC500-eCo	123
1TNE968902R2103	DI571	AC500-eCo	123
1TNE968902R2201	DO561	AC500-eCo	123
1TNE968902R2202	DO571	AC500-eCo	123
1TNE968902R2203	DO572	AC500-eCo	123
1TNE968902R2301	DX561	AC500-eCo	123
1TNE968902R2302	DX571	AC500-eCo	123

Index

Product type classification

Product type	Order code	Product range	Page
07AC91-AD	1SAP800000R0010	AC500/AC31 adapter	276
07AC91-AD2	1SAP800100R0010	AC500/AC31 adapter	276
07AI91-AD	1SAP800200R0010	AC500/AC31 adapter	276
07DC91-AD	1SAP800300R0010	AC500/AC31 adapter	276
07DC92-AD	1SAP800500R0010	AC500/AC31 adapter	276
07KT98-ARC-AD	1SAP801400R0060	AC500/AC31 adapter	276
07KT98-ARC-DP-AD	1SAP801100R0062	AC500/AC31 adapter	276
07KT98-ARC-ETH-AD	1SAP801200R0062	AC500/AC31 adapter	276
07KT98-ARC-ETH-DP-AD	1SAP801500R0062	AC500/AC31 adapter	276
07KT98-ETH-DP-AD	1SAP801300R0072	AC500/AC31 adapter	276
AC522	1SAP250500R0001	AC500	153
AC522-XC	1SAP450500R0001	AC500-XC	204
AI523	1SAP250300R0001	AC500	153
AI523-XC	1SAP450300R0001	AC500-XC	204
AI531	1SAP250600R0001	AC500	153
AI531-XC	1SAP450600R0001	AC500-XC	204
AI561	1TNE968902R1101	AC500-eCo	123
AI562	1TNE968902R1102	AC500-eCo	123
AI563	1TNE968902R1103	AC500-eCo	123
AI581-S	1SAP282000R0001	AC500-S	244
AI581-S-XC	1SAP482000R0001	AC500-S	245
AO523	1SAP250200R0001	AC500	153
AO523-XC	1SAP450200R0001	AC500-XC	204
AO561	1TNE968902R1201	AC500-eCo	123
AX521	1SAP250100R0001	AC500	153
AX521-XC	1SAP450100R0001	AC500-XC	204
AX522	1SAP250000R0001	AC500	153
AX522-XC	1SAP450000R0001	AC500-XC	204
AX561	1TNE968902R1301	AC500-eCo	123
CD522	1SAP260300R0001	AC500	153
CD522-XC	1SAP460300R0001	AC500-XC	204
CI501-PNIO	1SAP220600R0001	AC500	154
CI501-PNIO-XC	1SAP420600R0001	AC500-XC	205
CI502-PNIO	1SAP220700R0001	AC500	154
CI502-PNIO-XC	1SAP420700R0001	AC500-XC	205
CI504-PNIO	1SAP221300R0001	AC500	155
CI504-PNIO-XC	1SAP421300R0001	AC500-XC	205
CI506-PNIO	1SAP221500R0001	AC500	155
CI506-PNIO-XC	1SAP421500R0001	AC500-XC	205
CI511-ETHCAT	1SAP220900R0001	AC500	154
CI512-ETHCAT	1SAP221000R0001	AC500	154
CI521-MODTCP	1SAP222100R0001	AC500	154
CI521-MODTCP-XC	1SAP422100R0001	AC500-XC	205
CI522-MODTCP	1SAP222200R0001	AC500	154
CI522-MODTCP-XC	1SAP422200R0001	AC500-XC	205
CI541-DP	1SAP224100R0001	AC500	154
CI541-DP-XC	1SAP424100R0001	AC500-XC	205
CI542-DP	1SAP224200R0001	AC500	154
CI542-DP-XC	1SAP424200R0001	AC500-XC	205
CI581-CN	1SAP228100R0001	AC500	154
CI581-CN-XC	1SAP428100R0001	AC500-XC	205
CI582-CN	1SAP228200R0001	AC500	154
CI582-CN-XC	1SAP428200R0001	AC500-XC	205
CI590-CS31-HA	1SAP221100R0001	AC500	154
CI590-CS31-HA-XC	1SAP421100R0001	AC500-XC	205
CI592-CS31	1SAP221200R0001	AC500	154
CI592-CS31-XC	1SAP421200R0001	AC500-XC	205

Product type	Order code	Product range	Page
CM5610-2RS	1SAP176000R0020	AC500	151
CM5610-2RS-XC	1SAP376000R0020	AC500-XC	202
CM5640-2ETH	1SAP176000R0080	AC500	151
CM5640-2ETH-XC	1SAP376000R0080	AC500-XC	202
CM574-RCOM	1SAP170401R0201	AC500	151
CM574-RS	1SAP170400R0201	AC500	151
CM579-ETHCAT	1SAP170902R0101	AC500	151
CM579-PNIO	1SAP170901R0101	AC500	151
CM579-PNIO-XC	1SAP370901R0101	AC500-XC	202
CM582-DP	1SAP172200R0001	AC500	151
CM582-DP-XC	1SAP372200R0001	AC500-XC	202
CM588-CN	1SAP172800R0001	AC500	151
CM588-CN-XC	1SAP372800R0001	AC500-XC	202
CM589-PNIO	1SAP172900R0011	AC500	151
CM589-PNIO-4	1SAP172900R0111	AC500	151
CM589-PNIO-4-XC	1SAP372900R0111	AC500-XC	202
CM589-PNIO-XC	1SAP372900R0011	AC500-XC	202
CM592-DP	1SAP173200R0001	AC500	151
CM592-DP-XC	1SAP373200R0001	AC500-XC	202
CM597-ETH	1SAP173700R0001	AC500	151
CM597-ETH-XC	1SAP373700R0001	AC500-XC	202
CM598-CN	1SAP173800R0001	AC500	151
CM598-CN-XC	1SAP373800R0001	AC500-XC	202
CP604	1SAP504100R0001	CP600-eCo	258
CP604-B	1SAP504100R2001	CP600-eCo	258
CP607	1SAP507100R0001	CP600-eCo	258
CP607-B	1SAP507100R2001	CP600-eCo	258
CP610	1SAP510100R0001	CP600-eCo	258
CP610-B	1SAP510100R2001	CP600-eCo	258
CP6407	1SAP540710R0001	CP600	258
CP6410	1SAP541010R0001	CP600	258
CP6415	1SAP541510R0001	CP600	258
CP6605	1SAP560510R0001	CP600-Pro	259
CP6607	1SAP560710R0001	CP600-Pro	259
CP6610	1SAP561010R0001	CP600-Pro	259
CP6615	1SAP561510R0001	CP600-Pro	259
CP6621	1SAP562110R0001	CP600-Pro	259
DA501	1SAP250700R0001	AC500	153
DA501-XC	1SAP450700R0001	AC500-XC	204
DA502	1SAP250800R0001	AC500	153
DA502-XC	1SAP450800R0001	AC500-XC	204
DC522	1SAP240600R0001	AC500	152
DC522-XC	1SAP440600R0001	AC500-XC	203
DC523	1SAP240500R0001	AC500	152
DC523-XC	1SAP440500R0001	AC500-XC	203
DC532	1SAP240100R0001	AC500	152
DC532-XC	1SAP440100R0001	AC500-XC	203
DC541-CM	1SAP270000R0001	AC500	153
DC541-CM-XC	1SAP470000R0001	AC500-XC	204
DC551-CS31	1SAP220500R0001	AC500	154
DC551-CS31-XC	1SAP420500R0001	AC500-XC	205
DC562	1SAP231900R0000	AC500-eCo	123
DI524	1SAP240000R0001	AC500	152
DI524-XC	1SAP440000R0001	AC500-XC	203
DI561	1TNE968902R2101	AC500-eCo	123
DI562	1TNE968902R2102	AC500-eCo	123
DI571	1TNE968902R2103	AC500-eCo	123

Index

Product type classification

Product type	Order code	Product range	Page
DI572	1SAP230500R0000	AC500-eCo	123
DI581-S	1SAP284000R0001	AC500-S	244
DI581-S-XC	1SAP484000R0001	AC500-S	245
DM200-TOOL	1SAS010000R0102	Automation Builder	102
DM202-PREM	1SAS010002R0102	Automation Builder	102
DM204-TOOL-NW	1SAS010004R0102	Automation Builder	102
DM207-PVC	1SAS010007R0102	Automation Builder	102
DM210-PSA	1SAS010010R0102	Automation Builder	102
DM214-PVC-NW	1SAS010014R0102	Automation Builder	102
DM217-PSA-NW	1SAS010017R0102	Automation Builder	102
DM220-FSE	1SAS010020R0102	Automation Builder	102
DM221-FSE-NW	1SAS010021R0102	Automation Builder	102
DM250-VCP	1SAS010050R0102	Automation Builder	102
DM251-VCP-NW	1SAS010051R0102	Automation Builder	102
DM-KEY	1SAP193600R0001	Automation Builder	102
DO524	1SAP240700R0001	AC500	152
DO524-XC	1SAP440700R0001	AC500-XC	203
DO526	1SAP240800R0001	AC500	152
DO526-XC	1SAP440800R0001	AC500-XC	203
DO561	1TNE968902R2201	AC500-eCo	123
DO562	1SAP230900R0000	AC500-eCo	123
DO571	1TNE968902R2202	AC500-eCo	123
DO572	1TNE968902R2203	AC500-eCo	123
DO573	1SAP231300R0000	AC500-eCo	123
DX522	1SAP245200R0001	AC500	152
DX522-XC	1SAP445200R0001	AC500-XC	203
DX531	1SAP245000R0001	AC500	152
DX561	1TNE968902R2301	AC500-eCo	123
DX571	1TNE968902R2302	AC500-eCo	123
DX581-S	1SAP284100R0001	AC500-S	244
DX581-S-XC	1SAP484100R0001	AC500-S	245
FM502-CMS	1SAP260400R0001	AC500	147
FM502-CMS-XC	1SAP460400R0001	AC500-XC	198
FM562	1SAP233100R0001	AC500-eCo	124
MC5102	1SAP180100R0002	AC500-eCo	120
MC5102	1SAP180100R0002	AC500	158
MC5141	1SAP180100R0041	AC500	158
MC5141	1SAP180100R0041	AC500-XC	208
PB610	1SAP500900R0101	Automation Builder	259
PB610-R	1SAP500901R0101	Automation Builder	259
PM5012-R-ETH	1SAP122700R0072	AC500-eCo	118
PM5012-T-ETH	1SAP122600R0072	AC500-eCo	118
PM5032-R-ETH	1SAP123500R0072	AC500-eCo	118
PM5032-T-ETH	1SAP123400R0072	AC500-eCo	118
PM5052-R-ETH	1SAP124100R0072	AC500-eCo	118
PM5052-T-ETH	1SAP124000R0072	AC500-eCo	118
PM5072-T-2ETH	1SAP124500R0073	AC500-eCo	118
PM5072-T-2ETHW	1SAP124400R0073	AC500-eCo	118
PM5630-2ETH	1SAP131000R0278	AC500	148
PM5630-2ETH-XC	1SAP331000R0278	AC500-XC	199
PM5630-MC-KIT	1SAP131000R0379	AC500	148
PM5650-2ETH	1SAP141000R0278	AC500	148
PM5650-2ETH-XC	1SAP341000R0278	AC500-XC	199
PM5650-MC-KIT	1SAP141000R0379	AC500	148
PM5670-2ETH	1SAP151000R0278	AC500	148
PM5670-2ETH-XC	1SAP351000R0278	AC500-XC	199
PM5670-MC-KIT	1SAP151000R0379	AC500	148

Product type	Order code	Product range	Page
PM5675-2ETH	1SAP151500R0278	AC500	148
PM5675-2ETH-XC	1SAP351500R0278	AC500-XC	199
PM573-ETH	1SAP130300R0271	AC500	144
PM573-ETH-XC	1SAP330300R0271	AC500-XC	196
PM582	1SAP140200R0201	AC500	144
PM582-XC	1SAP340200R0201	AC500-XC	196
PM583-ETH	1SAP140300R0271	AC500	144
PM583-ETH-XC	1SAP340300R0271	AC500-XC	196
PM585-ETH	1SAP140500R0271	AC500	144
PM585-MC-KIT	1SAP140500R0379	AC500	144
PM590-ARCNET	1SAP150000R0261	AC500	144
PM590-ETH	1SAP150000R0271	AC500	144
PM590-MC-KIT	1SAP150000R0379	AC500	144
PM591-2ETH	1SAP150100R0277	AC500	144
PM591-ETH	1SAP150100R0271	AC500	144
PM591-ETH-XC	1SAP350100R0271	AC500-XC	196
PM592-ETH	1SAP150200R0271	AC500	144
PM592-ETH-XC	1SAP350200R0271	AC500-XC	196
PM595-4ETH-F	1SAP155500R0279	AC500	145
PM595-4ETH-M-XC	1SAP351500R0279	AC500-XC	196
PS552-MC-E	1SAP192100R0102	Automation Builder	103
PS5601-HA-MTCP	1SAP195400R0101	Automation Builder	103
PS5601-HA-MTCP	1SAP195400R0101	Automation Builder	119
PS5601-HA-MTCP	1SAP195400R0101	Automation Builder	149
PS5601-HA-MTCP	1SAP195400R0101	Automation Builder	200
PS5602-61850	1SAP195600R0101	Automation Builder	103
PS5602-61850	1SAP195600R0101	Automation Builder	119
PS5602-61850	1SAP195600R0101	Automation Builder	149
PS5602-61850	1SAP195600R0101	Automation Builder	200
PS5604-KNX	1SAP195800R0101	Automation Builder	103
PS5604-KNX	1SAP195800R0101	Automation Builder	119
PS5604-KNX	1SAP195800R0101	Automation Builder	149
PS5604-KNX	1SAP195800R0101	Automation Builder	200
PS5607-BACnet-BC	1SAP195550R0101	Automation Builder	103
PS5607-BACnet-BC	1SAP195550R0101	Automation Builder	119
PS5607-BACnet-BC	1SAP195550R0101	Automation Builder	149
PS5607-BACnet-BC	1SAP195550R0101	Automation Builder	200
PS5609-Log	1SAP195002R0101	Automation Builder	103
PS5609-Log	1SAP195002R0101	Automation Builder	119
PS5609-Log	1SAP195002R0101	Automation Builder	149
PS5609-Log	1SAP195002R0101	Automation Builder	200
PS5609-Log-e	1SAP195004R0101	Automation Builder	103
PS5609-Log-e	1SAP195004R0101	Automation Builder	119
PS5609-Log-e	1SAP195004R0101	Automation Builder	149
PS5609-Log-e	1SAP195004R0101	Automation Builder	200
PS5611-MC	1SAP192150R0101	Automation Builder	103
PS5611-MC	1SAP192150R0101	Automation Builder	119
PS5611-MC	1SAP192150R0101	Automation Builder	149
PS5611-MC	1SAP192150R0101	Automation Builder	200
PS5613-EIP-A	1SAP196100R0101	Automation Builder	103
PS5613-EIP-A	1SAP196100R0101	Automation Builder	119
PS5613-EIP-A	1SAP196100R0101	Automation Builder	149
PS5613-EIP-A	1SAP196100R0101	Automation Builder	200
PS5613-EIP-A-e	1SAP196102R0101	Automation Builder	103
PS5613-EIP-A-e	1SAP196102R0101	Automation Builder	119
PS5613-EIP-A-e	1SAP196102R0101	Automation Builder	149
PS5613-EIP-S	1SAP196101R0101	Automation Builder	103
PS5613-EIP-S	1SAP196101R0101	Automation Builder	119

Index

Product type classification

Product type	Order code	Product range	Page
PS5613-EIP-S	1SAP196101R0101	Automation Builder	149
PS5613-EIP-S	1SAP196101R0101	Automation Builder	200
PS5613-EIP-S-e	1SAP196103R0101	Automation Builder	103
PS5613-EIP-S-e	1SAP196103R0101	Automation Builder	119
PS5613-EIP-S-e	1SAP196103R0101	Automation Builder	149
PS562-SOLAR	1SAP195000R0101	Automation Builder	103
PS563-WATER	1SAS030000R0101	Automation Builder	103
PS564-TEMPCTRL	1SAS030010R0101	Automation Builder	103
PS565-BACnet-ASC	1SAP195500R0101	Automation Builder	103
SM560-S	1SAP280000R0001	AC500-S	244
SM560-S-FD-1	1SAP286000R0001	AC500-S	244
SM560-S-FD-1-XC	1SAP386000R0001	AC500-S	245
SM560-S-FD-4	1SAP286100R0001	AC500-S	244
SM560-S-FD-4-XC	1SAP386100R0001	AC500-S	245
SM560-S-XC	1SAP380000R0001	AC500-S	245
TA5101-4DI	1SAP187000R0001	AC500-eCo	121
TA5101-4DIW	1SAP187000R0201	AC500-eCo	121
TA5105-4DOT	1SAP187000R0002	AC500-eCo	121
TA5105-4DOTW	1SAP187000R0202	AC500-eCo	121
TA5110-2DI2DOT	1SAP187000R0003	AC500-eCo	121
TA5110-2DI2DOW	1SAP187000R0203	AC500-eCo	121
TA5120-2AI-UI	1SAP187100R0001	AC500-eCo	121
TA5120-2AI-UIW	1SAP187100R0201	AC500-eCo	121
TA5122-2AI-TC	1SAP187100R0004	AC500-eCo	121
TA5122-2AI-TCW	1SAP187100R0204	AC500-eCo	121
TA5123-2AI-RTD	1SAP187100R0002	AC500-eCo	121
TA5123-2AI-RTW	1SAP187100R0202	AC500-eCo	121
TA5126-2AO-UI	1SAP187100R0003	AC500-eCo	121
TA5126-2AO-UIW	1SAP187100R0203	AC500-eCo	121
TA5130-KNXPB	1SAP187200R0001	AC500-eCo	122
TA5130-KNXPBW	1SAP187200R0201	AC500-eCo	122
TA5131-RTC	1SAP187200R0002	AC500-eCo	120
TA5131-RTC	1SAP187200R0002	AC500-eCo	122
TA5141-RS232I	1SAP187300R0001	AC500-eCo	122
TA5141-RS232W	1SAP187300R0201	AC500-eCo	122
TA5142-RS485	1SAP187300R0003	AC500-eCo	122
TA5142-RS485I	1SAP187300R0002	AC500-eCo	122
TA5142-RS485IW	1SAP187300R0202	AC500-eCo	122
TA5142-RS485W	1SAP187300R0203	AC500-eCo	122
TA514-SAFETY	1SAP182900R0001	AC500-S	244
TA514-SAFETY	1SAP182900R0001	AC500-S	270
TA515-CASE	1SAP182400R0002	AC500	158
TA515-CASE	1SAP182400R0002	AC500	270
TA521	1SAP180300R0001	AC500	158
TA521	1SAP180300R0001	AC500-XC	208
TA5211-TSCL-B	1SAP187400R0001	AC500-eCo	120
TA5211-TSPF-B	1SAP187400R0002	AC500-eCo	120
TA5212-TSCL	1SAP187400R0004	AC500-eCo	120
TA5212-TSPF	1SAP187400R0005	AC500-eCo	120
TA5220-SPF5	1SAP187400R0012	AC500-eCo	122
TA5220-SPF6	1SAP187400R0013	AC500-eCo	122
TA5220-SPF7	1SAP187400R0014	AC500-eCo	122
TA5220-SPF8	1SAP187400R0015	AC500-eCo	122
TA523	1SAP180500R0001	AC500	158
TA523	1SAP180500R0001	AC500-XC	208
TA524	1SAP180600R0001	AC500	158
TA524	1SAP180600R0001	AC500-XC	208

Product type	Order code	Product range	Page
TA525	1SAP180700R0001	AC500	158
TA525	1SAP180700R0001	AC500-XC	208
TA526	1SAP180800R0001	AC500	158
TA526	1SAP180800R0001	AC500-XC	208
TA527	1SAP181100R0001	AC500	158
TA527	1SAP181100R0001	AC500-XC	208
TA528	1SAP181200R0001	AC500	158
TA528	1SAP181200R0001	AC500-XC	208
TA5300-CVR	1SAP187500R0001	AC500-eCo	120
TA5301-CFA	1SAP187500R0003	AC500-eCo	120
TA532	1SAP182000R0001	AC500	158
TA532	1SAP182000R0001	AC500-XC	208
TA533	1SAP182100R0001	AC500	158
TA533	1SAP182100R0001	AC500-XC	208
TA534	1SAP182200R0001	AC500	158
TA534	1SAP182200R0001	AC500-XC	208
TA535	1SAP182300R0001	AC500-XC	208
TA536	1SAP183100R0001	AC500	158
TA536	1SAP183100R0001	AC500-XC	208
TA540	1SAP182600R0001	AC500	158
TA540	1SAP182600R0001	AC500-XC	208
TA5400-SIM	1SAP187600R0001	AC500-eCo	120
TA541	1SAP182700R0001	AC500	158
TA541	1SAP182700R0001	AC500-XC	208
TA5415-STAKIT	1SAP187600R0002	AC500-eCo	271
TA5426-STAKIT	1SAP187600R0003	AC500-eCo	271
TA543	1SAP182800R0001	AC500-eCo	120
TA543	1SAP182800R0001	AC500	158
TA543	1SAP182800R0001	AC500-XC	208
TA5450-CASE	1SAP187700R0001	AC500	158
TA5450-CASE	1SAP187700R0001	AC500	270
TA563-11	1TNE968901R3102	AC500-eCo	124
TA563-9	1TNE968901R3101	AC500-eCo	124
TA564-11	1TNE968901R3104	AC500-eCo	124
TA564-9	1TNE968901R3103	AC500-eCo	124
TA565-11	1TNE968901R3106	AC500-eCo	124
TA565-9	1TNE968901R3105	AC500-eCo	124
TB511-ARCNET	1SAP111100R0260	AC500	146
TB511-ETH	1SAP111100R0270	AC500	146
TB511-ETH-XC	1SAP311100R0270	AC500-XC	197
TB521-ARCNET	1SAP112100R0260	AC500	146
TB521-ETH	1SAP112100R0270	AC500	146
TB521-ETH-XC	1SAP312100R0270	AC500-XC	197
TB523-2ETH	1SAP112300R0277	AC500	146
TB541-ETH	1SAP114100R0270	AC500	146
TB541-ETH-XC	1SAP314100R0270	AC500-XC	197
TB5600-2ETH	1SAP110300R0278	AC500	150
TB5600-2ETH-XC	1SAP310300R0278	AC500-XC	201
TB5610-2ETH	1SAP111300R0278	AC500	150
TB5610-2ETH-XC	1SAP311300R0278	AC500-XC	201
TB5620-2ETH	1SAP112300R0278	AC500	150
TB5620-2ETH-XC	1SAP312300R0278	AC500-XC	201
TB5640-2ETH	1SAP114300R0278	AC500	150
TB5640-2ETH-XC	1SAP314300R0278	AC500-XC	201
TB5660-2ETH	1SAP116300R0278	AC500	150
TB5660-2ETH-XC	1SAP316300R0278	AC500-XC	201
TF501-CMS	1SAP117000R0271	AC500	147

Index

Product type classification

Product type	Order code	Product range	Page
TF501-CMS-XC	1SAP317000R0271	AC500-XC	198
TF521-CMS	1SAP117200R0271	AC500	147
TF521-CMS-XC	1SAP317200R0271	AC500-XC	198
TK6028	1SAP506028R0001	CP600-Pro	259
TK6031	1SAP506031R0001	CP600-eCo, CP600	259
TK681	1SAP500981R0001	CP600-eCo, CP600	259
TK682	1SAP500982R0001	CP600-eCo, CP600	259
TU507-ETH	1SAP214200R0001	AC500	156
TU508-ETH	1SAP214000R0001	AC500	156
TU508-ETH-XC	1SAP414000R0001	AC500-XC	206
TU509	1SAP211000R0001	AC500	156
TU510	1SAP210800R0001	AC500	156
TU510-XC	1SAP410800R0001	AC500-XC	206
TU515	1SAP212200R0001	AC500	156
TU516	1SAP212000R0001	AC500	156
TU516-H	1SAP215000R0001	AC500	155
TU516-H-XC	1SAP415000R0001	AC500-XC	206
TU516-XC	1SAP412000R0001	AC500-XC	206
TU517	1SAP211400R0001	AC500	156
TU518	1SAP211200R0001	AC500	156
TU518-XC	1SAP411200R0001	AC500-XC	206
TU520-ETH	1SAP214400R0001	AC500	156
TU520-ETH-XC	1SAP414400R0001	AC500-XC	206
TU531	1SAP217200R0001	AC500	156
TU532	1SAP217000R0001	AC500	156
TU532-H	1SAP215100R0001	AC500	155
TU532-H-XC	1SAP415100R0001	AC500-XC	206
TU532-XC	1SAP417000R0001	AC500-XC	206
TU541	1SAP213000R0001	AC500	156
TU542	1SAP213200R0001	AC500	156
TU542-H	1SAP215200R0001	AC500	155
TU542-H-XC	1SAP415200R0001	AC500-XC	206
TU542-XC	1SAP413200R0001	AC500-XC	206
TU551-CS31	1SAP210600R0001	AC500	156
TU552-CS31	1SAP210400R0001	AC500	156
TU552-CS31-XC	1SAP410400R0001	AC500-XC	206
TU582-S	1SAP281200R0001	AC500-S	244
TU582-S-XC	1SAP481200R0001	AC500-S	245

Additional information

We reserve the right to make technical changes or modify the contents of this document without prior notice. ABB does not accept any responsibility whatsoever for potential errors or possible lack of information in this document.

We reserve all rights in this document and in the subject matter and illustrations contained therein. Any reproduction, disclosure to third parties or utilization of its contents – in whole or in parts – is forbidden without prior written consent of ABB.



ABB AG

Eppelheimer Straße 82
D-69123 Heidelberg / Germany
Tel.: +49 62 21 701 1444
Fax: +49 62 21 701 1382



new.abb.com/plc



new.abb.com/automationbuilder