

USER MANUAL

# PowerValue 11T G2

## 1-3 kVA B/S





# Document information

**File name** : 04-3598\_ABB\_OPM\_PVA11 1-3kVA-T\_G2\_EN\_REV-E  
**UPS model** : PowerValue 11 RT G2 1-3 kVA B/S  
**Date of issue** : 30.07.2018  
**Issued by** : Product Marketing  
**Checked by** : R&D  
After Sales  
**Article number** : 04-3598  
**Document number** : 4NWD003883  
**Revision** : E

# Contents

<b>Document information</b> . . . . .	<b>2</b>
<b>1 Safety</b> . . . . .	<b>5</b>
<b>1.1 Safety instructions</b> . . . . .	<b>5</b>
1.1.1 Safety symbols and warnings . . . . .	5
1.1.2 Installation . . . . .	6
1.1.3 Operation. . . . .	6
1.1.4 Maintenance, servicing, and faults . . . . .	7
1.1.5 Transport . . . . .	7
1.1.6 Storage . . . . .	7
1.1.7 Standards. . . . .	7
<b>1.2 UPS disposal and recycling.</b> . . . . .	<b>8</b>
1.2.1 For professional users in the European Union . . . . .	8
1.2.2 For disposal in countries outside of the European Union . . . . .	8
<b>2 Descriptions</b> . . . . .	<b>9</b>
<b>2.1 Panel descriptions</b> . . . . .	<b>9</b>
2.1.1 Display panel. . . . .	9
2.1.2 Display panel buttons . . . . .	9
2.1.3 LCD description . . . . .	10
2.1.4 LCD icon functions . . . . .	10
<b>3 Getting started</b> . . . . .	<b>11</b>
<b>3.1 Unpacking the UPS</b> . . . . .	<b>11</b>
3.1.1 Inspection . . . . .	11
3.1.2 Unpacking the system. . . . .	11
<b>3.2 Connection.</b> . . . . .	<b>12</b>
3.2.1 UPS input connection . . . . .	12
3.2.2 UPS output connection . . . . .	12
3.2.3 External batteries connection . . . . .	12
3.2.4 EPO Connection. . . . .	13
<b>3.3 Battery</b> . . . . .	<b>14</b>
<b>3.4 Turn on the UPS</b> . . . . .	<b>14</b>
<b>3.5 Turn off the UPS.</b> . . . . .	<b>14</b>
3.5.1 Battery recharge . . . . .	14
3.5.2 Test function. . . . .	14
3.4.1 With mains power connecting . . . . .	14
3.4.2 Without mains power connecting. . . . .	14
3.5.1 In Line Mode . . . . .	14
3.5.2 In Battery Mode . . . . .	14
<b>3.6 Alarm mute function</b> . . . . .	<b>15</b>
3.6.1 Battery mode . . . . .	15
3.6.2 Bypass mode. . . . .	15
3.6.3 CVCF mode. . . . .	15
3.6.4 Other modes. . . . .	15
3.6.5 Alarm indicators. . . . .	15
<b>4 Operation</b> . . . . .	<b>16</b>
<b>4.1 Operating modes for all models.</b> . . . . .	<b>16</b>
4.1.1 Operating modes and strings . . . . .	16
4.1.2 Warnings and fault strings . . . . .	16
4.1.3 Line mode (LINE) . . . . .	16
4.1.4 Battery mode (bATT). . . . .	17
4.1.5 Bypass mode (bYPA) . . . . .	17

4.1.6	No output mode (STbY)	17
4.1.7	Emergency Power Off (EPO)	17
4.1.8	Economy mode (ECO)	17
4.1.9	Constant Voltage Constant Frequency mode (CVCF)	17
4.1.10	Fault mode	17
<b>5</b>	<b>LCD settings</b>	<b>18</b>
5.1	LCD setting overview	18
5.1.1	Navigating the LCD	18
<b>6</b>	<b>Troubleshooting</b>	<b>19</b>
<b>7</b>	<b>Maintenance and storage</b>	<b>20</b>
7.1	Operation	20
7.2	Storage	20
<b>8</b>	<b>Communication ports</b>	<b>21</b>
8.1	USB and WinPower communication ports	21
8.1.1	USB and RS-232 communication ports	21
8.1.2	USB for HID power device	21
8.1.3	AS400 interface (optional)	21
8.1.4	WinPower ModBus card (optional)	21
8.1.5	WinPower SNMP card (optional)	21
<b>9</b>	<b>Software</b>	<b>22</b>
9.1	WinPower	22
9.1.1	Free software download—WinPower	22
9.1.2	Installation	22
<b>10</b>	<b>Rear panel view (IEC)</b>	<b>23</b>
<b>11</b>	<b>Technical specifications</b>	<b>25</b>
11.1	Technical Data Sheet	25
11.2	Battery runtime	26

## Tables

Table 1:	Safety symbols and warnings	5
Table 2:	Standards	7
Table 3:	PowerValue 11T G2 1-3 kVA display panel buttons	9
Table 4:	LCD icons	10
Table 5:	UPS model output sockets	12
Table 6:	Connecting output and ground wires to terminal block	12
Table 7:	EBM and corresponding UPS model connections	12
Table 8:	Alarm function list	15
Table 9:	Operating modes and strings	16
Table 10:	Warning and fault codes	16
Table 11:	LCD mode setting options	18
Table 12:	Warning and fault codes	19
Table 13:	Battery runtime values	26

## Figures

Figure 01	The air flow diagram	6
Figure 02	The display panel	9
Figure 03	The LCD display	10
Figure 04	Unpacking the system	11
Figure 05	Output connection diagram of 3kVA S	12
Figure 06	UPS Connect to EBM	13
Figure 07	The line mode	16
Figure 08	The battery mode	17
Figure 09	The bypass mode	17
Figure 10	The no output mode	17
Figure 11	The fault mode	17
Figure 12	The LCD display panel	18
Figure 13	WinPower	22
Figure 14	PowerValue 11T G2 1kVA B and PowerValue 11T G2 1kVA S	23
Figure 15	PowerValue 11T G2 2kVA B and PowerValue 11T G2 2kVA S	23
Figure 16	PowerValue 11T G2 3kVA B and PowerValue 11T G2 3kVA S	24

# 1 Safety









READ THIS IMPORTANT SAFETY  
INSTRUCTION CHAPTER BEFORE  
READING THE OPERATING MANUAL.

## 1.1 Safety instructions

### 1.1.1 Safety symbols and warnings

The following symbols are used in this manual.  
The list below explains each symbol.

Table 1: Safety symbols and warnings

	This symbol in conjunction with the signal word "DANGER" indicates an imminent electrical hazard. Failure to observe the related safety note may cause injury, death, or equipment damage.
	This symbol in conjunction with the signal word "WARNING" indicates a potentially dangerous situation. Failure to observe may cause injury, death, or equipment damage.
	This symbol in conjunction with the signal word "NOTE" indicates operator tips or particularly useful or important information for the use of the product. This symbol and wording do not indicate a dangerous situation.
	This symbol indicates that reading the instruction manual/booklet before starting work or before operating equipment or machinery is compulsory.
	This symbol indicates material to be recycled.
	This symbol indicates material that cannot be disposed in ordinary trash.

—  
01 The air flow diagram

### 1.1.2 Installation

Always follow the precautions and instructions described in this manual. Any deviation from instructions may result in electric shock or cause accidental load loss.



WARNING

CONDENSATION MAY OCCUR IF THE UPS IS SUDDENLY MOVED FROM A COLD TO A WARM ENVIRONMENT. THE UPS MUST BE ABSOLUTELY DRY BEFORE INSTALLATION. IT IS RECOMMENDED TO HAVE AN ACCLIMATIZATION TIME OF AT LEAST TWO HOURS TO PREVENT CONDENSATION.



WARNING

DO NOT INSTALL THE UPS NEAR WATER OR IN A DAMP ENVIRONMENT.



WARNING

DO NOT INSTALL THE UPS WHERE IT WOULD BE EXPOSED TO DIRECT SUNLIGHT OR NEAR A HEAT SOURCE.



WARNING

DO NOT CONNECT APPLIANCES OR ITEMS OF EQUIPMENT WHICH WOULD OVERLOAD THE UPS (E.G. LASER PRINTERS, ETC.) TO THE UPS OUTPUT.



WARNING

PLACE CABLES PROPERLY TO AVOID STEPPING ON OR TRIPPING OVER THEM.



WARNING

MAKE CERTAIN TO PROPERLY GROUND LINES.



WARNING

ONLY CONNECT THE UPS TO OUTLETS WHICH ARE PROPERLY GROUNDED.



WARNING

AFTER INSTALLING THE EQUIPMENT, MAKE SURE THAT THE TOTAL LEAKAGE CURRENT DOES NOT EXCEED 3.5 mA



WARNING

DO NOT BLOCK VENTILATION OPENINGS ON THE UPS'S HOUSING. ENSURE THE AIR VENTS ON THE FRONT, SIDE, AND REAR OF THE UPS ARE NOT BLOCKED. RECOMMENDED AT LEAST 25CM OF SPACE ON EACH SIDE. THE AIR FLOW DIAGRAM IS SHOWN AS BELOW:

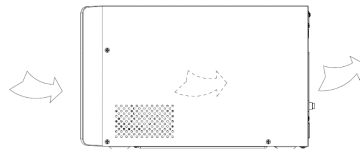

—  
01



WARNING

AN ADDITIONAL CIRCUIT BREAKER OR FUSE WITH A 16A RATING AND 3KA BREAKING CAPACITY SHALL BE USED BETWEEN THE POWER SOURCE AND INPUT WHEN INSTALLING THIS UNIT.



DANGER

THIS UPS RECEIVES POWER FROM MORE THAN ONE SOURCE—DISCONNECTION OF AC SOURCE AND DC SOURCE IS REQUIRED TO DE-ENERGIZE THIS UNIT BEFORE SERVICING.

### 1.1.3 Operation



WARNING

FOR SAFETY REASONS, DO NOT DISCONNECT THE MAINS CABLE ON THE UPS OR THE BUILDING WIRING SOCKET (GROUNDED SHOCKPROOF SOCKET) DURING OPERATION. THE GROUNDING FOR THE UPS AND ALL LOADS CONNECTED WILL BE DISCONNECTED.



DANGER

THE UPS FEATURES ITS OWN INTERNAL CURRENT SOURCE (BATTERIES). YOU COULD BE SHOCKED WHEN YOU TOUCH THE UPS OUTPUT SOCKETS OR OUTPUT TERMINAL BLOCK EVEN IF THE UPS IS NOT CONNECTED TO THE BUILDING WIRING SOCKET.



DANGER

ENSURE THAT NO LIQUID OR OTHER EXTERNAL OBJECTS CAN ENTER THE UPS.



DANGER

REMOVE THE PROTECTIVE PANEL ONLY AFTER DISCONNECTING THE TERMINAL CONNECTIONS.



NOTE

IN ORDER TO FULLY DISCONNECT THE UPS, FIRST PRESS THE OFF BUTTON TO TURN OFF THE UPS, AND THEN DISCONNECT THE MAINS LEAD.

**1.1.4 Maintenance, servicing, and faults**



DANGER

THE UPS OPERATES WITH HAZARDOUS VOLTAGES.



DANGER

CAUTION—RISK OF ELECTRIC SHOCK. EVEN AFTER THE UNIT IS DISCONNECTED FROM THE MAINS POWER SUPPLY (BUILDING WIRING SOCKET), COMPONENTS INSIDE THE UPS ARE STILL CONNECTED TO THE BATTERY WHICH ARE POTENTIALLY DANGEROUS.



DANGER

BEFORE CARRYING OUT ANY SERVICE AND/OR MAINTENANCE, DISCONNECT THE BATTERIES. VERIFY THAT NO CURRENT IS PRESENT, AND NO HAZARDOUS VOLTAGE EXISTS IN THE CAPACITOR OR BUS CAPACITOR TERMINALS.



DANGER

RISK OF ELECTRIC SHOCK. THE BATTERY CIRCUIT IS NOT ISOLATED FROM THE INPUT VOLTAGE. HAZARDOUS VOLTAGES MAY OCCUR BETWEEN THE BATTERY TERMINALS AND THE GROUND. VERIFY THAT NO VOLTAGE IS PRESENT BEFORE SERVICING.



DANGER

BATTERIES HAVE A HIGH SHORT-CIRCUITED CURRENT AND POSE A RISK OF SHOCK. TAKE ALL PRECAUTIONARY MEASURES SPECIFIED BELOW AND ANY OTHER MEASURES NECESSARY WHEN WORKING WITH BATTERIES:  
 REMOVE ALL JEWELRY, WRISTWATCHES, RINGS, AND OTHER METAL OBJECTS.  
 • USE ONLY TOOLS WITH INSULATED GRIPS AND HANDLES.  
 • WEAR RUBBER GLOVES AND BOOTS.  
 • DO NOT LAY TOOLS OR METAL PARTS ON TOP OF BATTERIES.  
 • DISCONNECT THE CHARGING SOURCE PRIOR TO CONNECTING OR DISCONNECTING BATTERY TERMINALS.



DANGER

DO NOT ATTEMPT TO DISPOSE OF BATTERIES BY BURNING THEM. IT COULD CAUSE AN EXPLOSION.



DANGER

DO NOT OPEN OR DESTROY BATTERIES. EFFLUENT ELECTROLYTES CAN CAUSE INJURY TO THE SKIN AND EYES. IT MAY BE TOXIC.



WARNING

WHEN CHANGING BATTERIES, REPLACE WITH THE SAME QUANTITY AND THE SAME TYPE OF BATTERIES.



WARNING

WHEN REPLACING FUSES, USE THE SAME TYPE AND AMPERAGE IN ORDER TO AVOID FIRE HAZARDS.

**1.1.5 Transport**



WARNING

TRANSPORT THE UPS ONLY IN THE ORIGINAL PACKAGING (TO PROTECT AGAINST SHOCK AND IMPACT).

**1.1.6 Storage**



WARNING

THE UPS MUST BE STOCKPILED IN THE ROOM WHERE IT IS VENTILATED AND DRY.

**1.1.7 Standards**

**Table 2: Standards**

	Product Standards
<b>Safety</b>	IEC/EN 62040-1
<b>EMI</b>	
Conducted Emission	IEC/EN 62040-2
Radiated Emission	IEC/EN 62040-2
Harmonic Current	IEC/EN 61000-3-2
Voltage Fluctuation and Flicker	IEC/EN 61000-3-3
<b>EMS</b>	
ESD	IEC/EN 61000-4-2
RS	IEC/EN 61000-4-3
EFT	IEC/EN 61000-4-4
SURGE	IEC/EN 61000-4-5
CS	IEC/EN 61000-4-6
MS	IEC/EN 61000-4-8
Voltage Dips	IEC/EN 61000-4-11
Low Frequency Signals	IEC/EN 61000-2-2

---

## 1.2 UPS disposal and recycling

### 1.2.1 For professional users in the European Union

---

THE CROSSED-OUT WHEELED BIN SYMBOL ON THE PRODUCT(S) AND / OR ACCOMPANYING DOCUMENTS MEANS THAT USED ELECTRICAL AND ELECTRONIC EQUIPMENT (WEEE) SHOULD NOT BE MIXED WITH GENERAL HOUSEHOLD WASTE.



IF YOU WISH TO DISCARD ELECTRICAL AND ELECTRONIC EQUIPMENT (EEE), PLEASE CONTACT YOUR DEALER OR SUPPLIER FOR FURTHER INFORMATION.

DISPOSING OF THIS PRODUCT CORRECTLY WILL HELP SAVE VALUABLE RESOURCES AND PREVENT ANY POTENTIAL NEGATIVE EFFECTS ON HUMAN HEALTH AND THE ENVIRONMENT, WHICH COULD OTHERWISE ARISE FROM INAPPROPRIATE WASTE HANDLING.

---

### 1.2.2 For disposal in countries outside of the European Union

---

THE CROSSED-OUT WHEELED BIN SYMBOL IS ONLY VALID IN THE EUROPEAN UNION (EU) AND MEANS THAT USED ELECTRICAL AND ELECTRONIC EQUIPMENT (WEEE) SHOULD NOT BE MIXED WITH GENERAL HOUSEHOLD WASTE.



IF YOU WISH TO DISCARD THIS PRODUCT PLEASE CONTACT YOUR LOCAL AUTHORITIES OR DEALER AND ASK FOR THE CORRECT METHOD OF DISPOSAL.

DISPOSING OF THIS PRODUCT CORRECTLY WILL HELP SAVE VALUABLE RESOURCES AND PREVENT ANY POTENTIAL NEGATIVE EFFECTS ON HUMAN HEALTH AND THE ENVIRONMENT, WHICH COULD OTHERWISE ARISE FROM INAPPROPRIATE WASTE HANDLING.

---



# 2 Descriptions

## 2.1 Panel descriptions

02 The display panel

### 2.1.1 Display panel

The PowerValue 11T G2 1-3 kVA display panel is shown below.

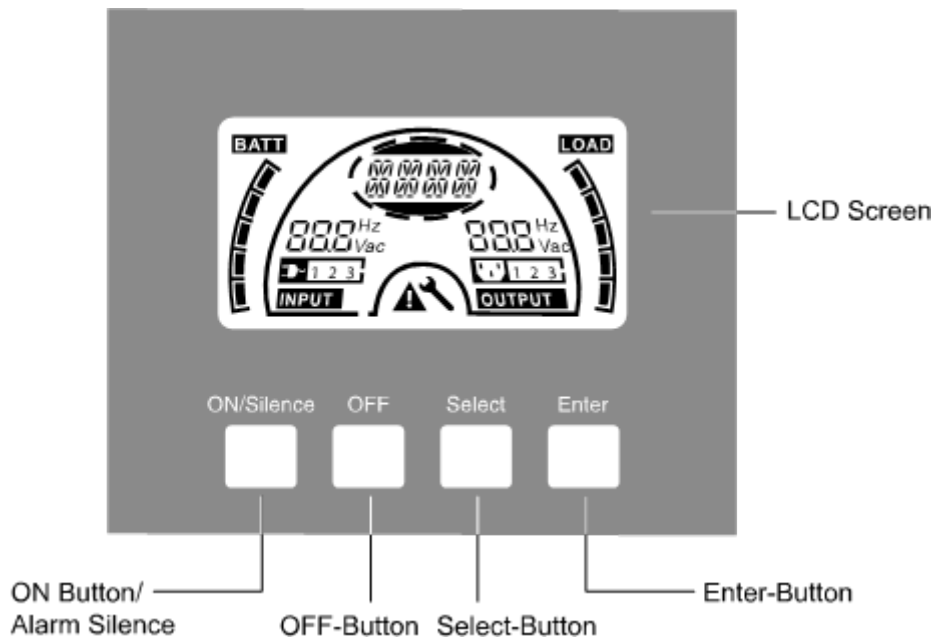

02

### 2.1.2 Display panel buttons

**Table 3: PowerValue 11T G2 1-3 kVA display panel buttons**

Switch	Functions
<b>ON/Silence</b>	<ol style="list-style-type: none"> <li>Turn on the UPS system:                             <ol style="list-style-type: none"> <li>By pressing the ON/Silence button continuously for more than 1 second, the UPS system is turned on.</li> </ol> </li> <li>Deactivate the acoustic alarm:                             <ol style="list-style-type: none"> <li>By pressing this button, an acoustic alarm can be deactivated in the battery mode.</li> <li>Using a short touch, all acoustic alarms can be deactivated in all modes.</li> </ol> </li> <li>Do the battery test:                             <ol style="list-style-type: none"> <li>By pressing this button, the UPS can do the battery test in the Line mode, ECO mode, or CVCF mode.</li> </ol> </li> </ol>
<b>OFF</b>	<ol style="list-style-type: none"> <li>When mains power is normal, the UPS system switches to No output or Bypass mode by pressing the OFF button, and the inverter is off. If Bypass is enabled and the mains power is available, the output sockets are supplied with voltage via the bypass.</li> <li>Deactivate acoustic alarm:                             <ol style="list-style-type: none"> <li>By pressing this button, an acoustic alarm can be deactivated in the bypass mode.</li> </ol> </li> <li>Release the UPS from fault mode and EPO status.</li> </ol>
<b>Select</b>	Can select and alternate between the following modes using "Select" and confirming with: <ul style="list-style-type: none"> <li>Output voltage (OPV)</li> <li>Output frequency (OPF)</li> <li>Bypass disable/enable</li> <li>Operating mode in No output or Bypass mode</li> </ul>
<b>Enter</b>	<ul style="list-style-type: none"> <li>External Battery pack number</li> <li>Battery remain time display disable/enable</li> <li>Charger current in all mode</li> </ul>

2.1.3 LCD description

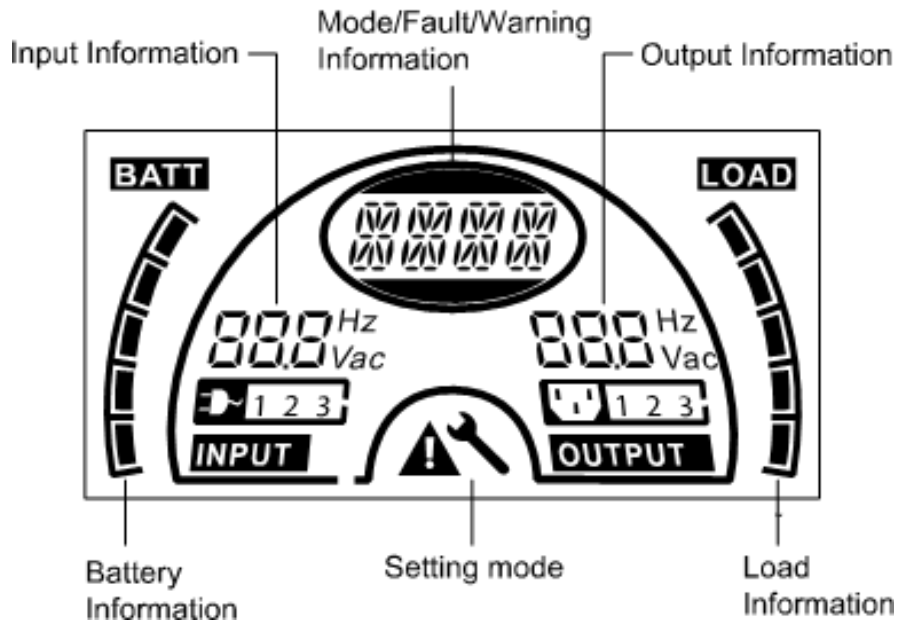

LCD idle function:

If you enable LCD background idle function when UPS standby mode is turned off, the LCD background will be turned off within 5 seconds. Pressing any key will turn the LCD background light on.

2.1.4 LCD icon functions

Table 4: LCD icons

Display	Function
<b>Input Information</b>	
	Indicates input voltage/frequency value, which are displayed separately.
	Indicates the input relevant to mains, and the input power is single phase input.
<b>Output Information</b>	
	Indicates output voltage/frequency value, which are displayed separately.
<b>Load Information</b>	
	Indicates the load level. Every section represents the level at 20%. One section is displayed if the level is between 0-20%.
<b>Battery Information</b>	
	Indicates the battery capacity. Every section represents the capacity at 20%. If the battery low alarm occurs, the lowest grid will flash to remind you.
<b>Mode/Fault/Warning Information</b>	
	Indicates: <ul style="list-style-type: none"> <li>• Operating mode</li> <li>• Fault</li> <li>• Warning</li> <li>• Battery remain time</li> </ul> Different warning signals can display alternately at the same time.
<b>Else</b>	
	Indicates the UPS is in Settings mode.
	Indicates the UPS is in Fault mode or has some warnings.

# 3 Getting started

## 3.1 Unpacking the UPS

—  
04 Unpacking  
the system

### 3.1.1 Inspection

Inspect the packaging and its contents for damage. Inform the transport agency immediately if you find signs of damage.

Keep the packaging in a safe place for future use.

### 3.1.2 Unpacking the system

1. Open the outer carton and take out the accessories.
2. Lift the UPS from the outer carton carefully, remove the foam, and set the UPS on a flat, stable surface.

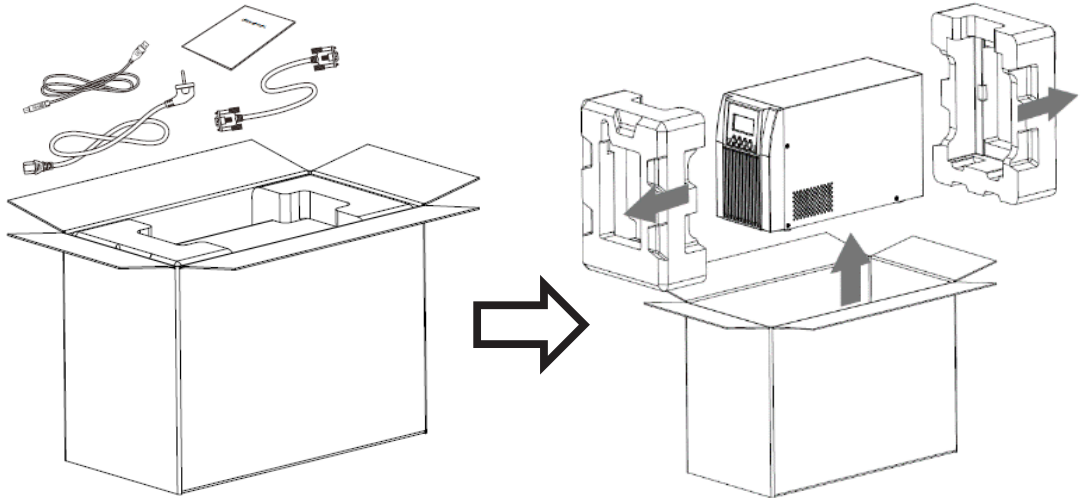

—  
04



DISCARD OR RECYCLE THE PACKAGING IN A RESPONSIBLE MANNER OR STORE IT FOR FUTURE USE.



NOTE

THE CABINET IS HEAVY. SEE THE WEIGHT PROVIDED ON THE PACKAGING/LABEL.

# 3.2 Connection

05 Output connection diagram of 3kVA S

### 3.2.1 UPS input connection

If the UPS is connected via the power cord, use a proper socket (grounded and shockproof) and pay attention to the capacity of the socket. The UPS system has an input breaker on the standard cabinet.

### 3.2.2 UPS output connection

The output sockets and types of the UPS are shown below.

Table 5: UPS model output sockets

Model No.	Output Socket -IEC(pcs)
PowerValue 11T G2 1 kVA B	4*C13
PowerValue 11T G2 1 kVA S	3*C13
PowerValue 11T G2 2 kVA B	4*C13
PowerValue 11T G2 2 kVA S	6*C13
PowerValue 11T G2 3 kVA B	4*C13+1*C19
PowerValue 11T G2 3 kVA S	3*C13+Terminal block

For PowerValue 11T G2 3kVA S model, connect the output and ground wires to the terminal block according to Figure 5 and Table 6 shown below.

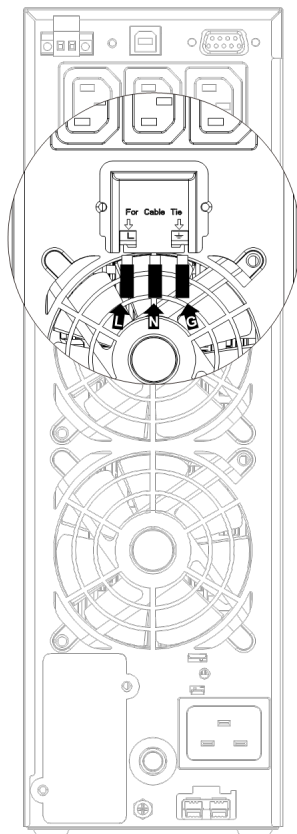

Table 6: Connecting output and ground wires to terminal block

Terminal position	Wire function	Terminal wire size rating	Tightening torque
L	Line Out	1.5mm <sup>2</sup> -	
N	Neutral Out	2.5mm <sup>2</sup>	0.5Nm
⊥	Output Ground	(14AWG-12AWG)	(4.4 Lb In)

### 3.2.3 External batteries connection

When connecting the external batteries modules (EBM), it is recommended to use the EBM that matches the corresponding UPS model.

Table 7: EBM and corresponding UPS model connections

UPS Model	EBM model
PowerValue 11T G2 1 kVA B	External battery 11T G2 1 kVA
PowerValue 11T G2 1 kVA S	External battery 11T G2 1 kVA
PowerValue 11T G2 2 kVA B	External battery 11T G2 2 kVA
PowerValue 11T G2 2 kVA S	External battery 11T G2 2 kVA
PowerValue 11T G2 3 kVA B	External battery 11T G2 3 kVA
PowerValue 11T G2 3 kVA S	External battery 11T G2 3 kVA



WARNING

CONNECTING THE WRONG EBM WILL CAUSE ABNORMALITY OR PERMANENT DAMAGE.

A STANDARD TYPE BATTERY CONNECTOR ON THE REAR PANEL IS USED FOR CONNECTING THE BATTERY PACK.



DANGER

IN CASE OF INSTALLING A CUSTOMIZED EXTERNAL BATTERY PACKAGE, IT IS VERY IMPORTANT TO FOLLOW THE NEXT STEPS TO AVOID THE RISK OF ELECTRICAL SHOCK.

1. Prepare the battery cable and connector able to withstand the needed current.
2. Install a proper DC breaker between the UPS and the external batteries.
3. If there is a battery breaker, turn it off first. Then connect the battery cable to the EBM connector on the rear of the UPS.
4. Connect the input power cord of the UPS to mains power supply. The battery will start to charge.

06 UPS Connect to EBM

When using standard ABB EBMs, connect them according to Figure 6.



WARNING

WARNING—THE OUTPUT SOCKETS OF THE UPS SYSTEM MAY STILL HAVE LIVE ELECTRICAL CURRENT EVEN IF THE POWER SUPPLY SYSTEM HAS BEEN DISCONNECTED.

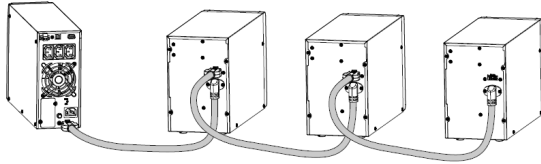

06

### 3.2.4 EPO Connection

Emergency Power Off (EPO) function is a standard feature for the UPS. The EPO polarity is configurable, and it is normally closed as a default setting. If the connection between the two ports of the EPO connector is disconnected, EPO function will be active, and the UPS will stop output power immediately.

#### 3.2.4.1 Normally open

Normally the EPO connector is open on the rear panel. Once the connector is closed with a wire, the UPS will stop output until the EPO status is reset.

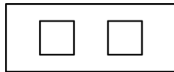

Disable EPO status

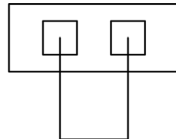

Enable EPO status

#### 3.2.4.2 Normally closed

Normally the EPO connector is closed with a wire on the rear panel. Once the connector is open, the UPS will stop output until the EPO status is disabled.



Enable EPO status

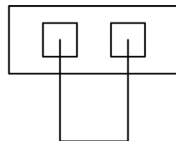

Disable EPO status

---

## 3.3 Battery

### 3.3.1 Battery recharge

Fully charge the UPS system's external batteries by leaving the UPS system connected to the mains power for approximately 1-2 hours. The UPS system can operate directly without recharging, but the backup time may be shorter than the nominal value specified.

### 3.3.2 Test function

Test function means checking the UPS system's battery performance by pressing the On-Switch for more than 1 second while the UPS is operating in Line mode. The UPS will detect whether the battery is connected, or if the battery is weak. The UPS can implement this test automatically and periodically. The battery test period is configurable.

---

## 3.4 Turn on the UPS

### 3.4.1 With mains power connecting

Press and hold the ON button for more than 1 second to turn on the UPS. The UPS will be in Line mode; and the LCD screen will indicate the state of the UPS.

### 3.4.2 Without mains power connecting

Even though mains power is not connected to the UPS, the UPS still can be turned on by just simply pressing the ON button continuously for more than 1 second when the external batteries connected. The UPS will turn on in Battery mode, and the LCD screen will indicate the state of the UPS.



NOTE

BY DEFAULT, THE OUTPUT IS DISABLED WHEN THE UPS IS IN BYPASS MODE; THIS CAN BE MANAGED IN THE USER SETTINGS (SEE 5.1).

---

---

## 3.5 Turn off the UPS

### 3.5.1 In Line Mode

Press the OFF button continuously for more than 1 second to turn off the UPS. The UPS will enter no output or bypass mode. In some circumstances, the UPS might have output power if bypass mode is enabled. Disconnect the mains power to turn off the output.

### 3.5.2 In Battery Mode

Press the OFF button continuously for more than 1 second to turn off the UPS. The UPS will enter no output or standby mode. After 10 seconds, the UPS will be shut down completely.

## 3.6 Alarm mute function

### 3.6.1 Battery mode

To mute the audio alarm in battery mode, press the ON button continuously for 1 second. The audio alarm is active again when the battery reaches low status as a reminder that the UPS output power will shut down soon.

### 3.6.2 Bypass mode

To mute the audio alarm in bypass mode, press the OFF button continuously for more than 1 second. This does not affect the warning and fault alarm.

### 3.6.3 CVCF mode

The UPS can be used in CVCF mode without batteries. This will cause the Open Battery alarm to sound. To mute this alarm in CVCF mode, use the software.

### 3.6.4 Other modes

To mute the audio alarm in any other mode, press the ON button for less than half (0.5) a second. You can enable the audio alarm again by pressing the ON button for less than half (0.5) a second again. If the new warning or fault alarm appears, the buzzer will beep again.

### 3.6.5 Alarm indicators

The audio alarm has a series of beeps based on the active mode or a particular warning. See Table 8 below for the number/duration of beeps for warning/mode.

Table 8: Alarm function list

No.	Status	Alarm
1	Battery mode	Beeps once every 4 seconds.
2	Battery mode with battery low	Beeps once every second.
3	Bypass mode	Beeps once every 2 minutes.
4	Overload	Beeps twice every second.
5	Warning active (See Warning & Fault Code Table)	Beeps once every second.
6	Fault active	Beeps continuously.
7	Button function active	Beeps once.

# 4 Operation

## 4.1 Operating modes for all models

07 The line mode

### 4.1.1 Operating modes and strings

Different messages/strings are displayed on the LCD screen corresponding to different UPS operating modes, as shown in Table 9.

**Table 9: Operating modes and strings**

Operating mode	Code
No output mode	STbY
Bypass mode	bYPA
Line mode	LINE
Battery mode	bATT
Battery test mode	TEST
ECO mode	ECO
Converter mode	CVCF

### 4.1.2 Warnings and fault strings

Additionally, different strings, as shown in Table 10 display with a particular warning or fault. Only one normal operating string or fault string is presented at a time. However, if several warnings happen at the same time, they display on the LCD alternately. In this case, the normal operating mode string and the warning string will be shown alternately. Once a fault occurs, all previous warnings will not be shown again; only the fault string will be presented.

**Table 10: Warning and fault codes**

Warning	SITE
Site fail	SITE
Fan fail	FANF
Battery over voltage (over charged)	HIGH
Battery low	bLOW
Charge fail	CHGF
Inverter temperature high	TEPH
Battery open	bOPN
Overload	OVLd
Digital bigger charger fail	dCHF
Inner temperature high	ITPH

Fault	String
Inverter short	SHOR
Overload fault	OVLd
Inverter soft start fail	ISFT
Bus soft start fail	bsFT
Over temperature fault	OVTp
Inverter Volt Low	INVL
Inverter Volt High	INVH
Bus volt over	bUSH
Bus volt Low	bUSL
Bus short	bUSS
Inverter NTC open	NTCO
Emergency Power Off	EPO

### 4.1.3 Line mode (LINE)

**i**  
NOTE

EACH MODE DISPLAYS INFORMATION ABOUT THE MAINS POWER, THE BATTERY LEVEL, THE UPS OUTPUT, AND THE LOAD LEVEL.

The LCD display in Line mode is shown as Figure 7. The “LINE” string indicates the UPS is working in Line mode.

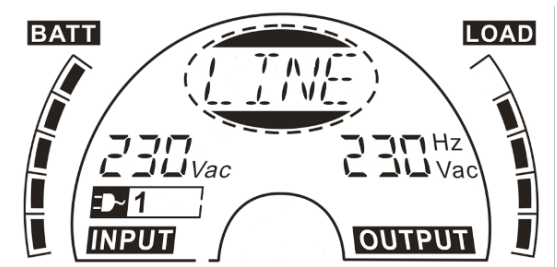

07



- 
- 08 The battery mode
- 
- 09 The bypass mode
- 
- 10 The no output mode
- 
- 11 The fault mode

#### 4.1.4 Battery mode (bATT)

The LCD display in battery mode is shown as Figure 8. The “bATT” string indicates the UPS working in the battery mode. If the function of battery remain time is set to enable, the “bATT” string and battery remaining time (in minutes or seconds) would display in turn every 2s.

When the UPS is running in battery mode, the buzzer beeps once every 4 seconds. If the ON button on the front panel is pressed for more than 1 second, the buzzer will stop beeping (in silence mode). Press the ON button once again for more than 1 second to resume the alarm function.



—  
08

#### 4.1.5 Bypass mode (bYPA)

The LCD display in bypass mode is shown as Figure 9. The “bYPA” string indicates the UPS working in the bypass mode. The UPS beeps once every 2 minutes in bypass mode.

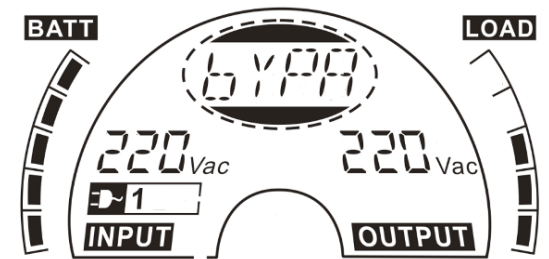

—  
09

#### 4.1.6 No output mode (STbY)

The LCD display in No output mode is shown as Figure 10. The “STbY” string indicates UPS working in the No output mode.

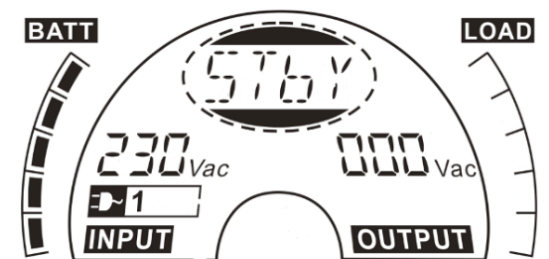

—  
10

#### 4.1.7 Emergency Power Off (EPO)

The EPO is also referred to as the Remote Power Off (RPO). On the LCD display, the word “EPO” is presented in the same position as the output voltage.

The EPO is a specific status in which the UPS will shut off the output and send out an alarm. The EPO status must be reset before turning off the UPS. The OFF button will not turn off the UPS during an EPO status.

#### 4.1.8 Economy mode- (ECO)

ECO mode is also referred to as high-efficiency mode. You must turn the UPS on in ECO mode. Output power is supplied from mains power directly via an internal filter while the mains power is within a certain range, so high-efficiency performance is achieved in ECO mode. Once the mains power is lost or out of range, the UPS transfers to battery mode, and the load is supplied continuously by the battery.

1. ECO mode is enabled through the LCD setting or the software (WinPower, etc.).
2. The transfer time of the UPS output from ECO mode to battery mode is less than 10 milliseconds. It is suggested to take this into account when applying sensitive loads.

#### 4.1.9 Constant Voltage Constant Frequency mode (CVCF)

In Constant Voltage Constant Frequency (CVCF) mode, also known as converter mode, the UPS works in a frequency free-run with a fixed output frequency (50Hz or 60Hz). Once the mains are lost or abnormal, the UPS transfers to battery mode, and the load is supplied continuously by the battery.

1. CVCF mode is enabled through the LCD setting or the software (WinPower, etc.).
2. The normal power rating is derating to 60% in converter mode.

#### 4.1.10 Fault mode

When a fault occurs, (see Table 10), the corresponding fault string is shown on the LCD display to indicate the status of the UPS, and the background light turns to red. For example, “SHOR” is shown when the connected load or the UPS output is in short-circuited, as shown on the LCD display below in Figure 11.



—  
11

# 5 LCD settings

## 5.1 LCD setting overview

12 The LCD display panel

You can use the LCD module to access the settings for each operating mode.

The available modes are displayed in the center oval. Table 11 below shows the different display name acronyms for each mode.

**Table 11: LCD mode setting options**

String	Meaning	Setting Options
OPV	Output voltage	Voltage options are: <ul style="list-style-type: none"> <li>• 220V</li> <li>• 230V</li> <li>• 240V</li> </ul>
OPF	Output frequency	Frequency options are: <ul style="list-style-type: none"> <li>• 50Hz</li> <li>• 60 Hz</li> </ul>
bYPA	Bypass status	<ul style="list-style-type: none"> <li>• Select 000 for Bypass Disable.</li> <li>• Select 001 for Bypass Enable.</li> <li>• UPS will enter bypass mode after several seconds if Bypass Enable is selected.</li> <li>• UPS will turn to no output mode after several seconds if Bypass Disable is selected.</li> </ul>
MOdE	Operating mode	<ul style="list-style-type: none"> <li>• UPS—Normal operating mode</li> <li>• ECO—High-efficiency mode</li> <li>• CVF—Converter mode</li> </ul>
EbPN	External battery pack number	<ul style="list-style-type: none"> <li>• Values are 000 or 009.</li> <li>• 009 means there are 9 external battery packs.</li> </ul>
bATT	Battery remaining time	Battery time values are: <ul style="list-style-type: none"> <li>• 000—Battery remaining time function is disabled and will not display on LCD in battery mode.</li> <li>• 001—Battery remaining time function is enabled, and the time will display (minutes or seconds) in battery mode or battery test mode. bATT will display on LCD every 2s.</li> </ul>
CHG	Charger current	<ul style="list-style-type: none"> <li>• 3.0/6.0 for 1KL T (3.0 stands for 3A charger)</li> <li>• 1.5/3.0/4.5/6.0 for 2KL/3KL T</li> </ul>

### 5.1.1 Navigating the LCD

To access settings mode on the LCD display panel, press the “Enter” button for more than 1 second.

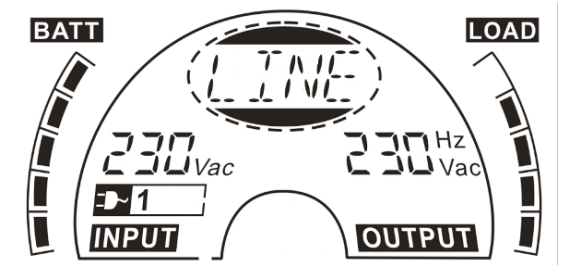

12

The above modes are displayed individually in the center oval. You can cycle through each mode by pressing and holding “Enter” and then pressing “Select.”

## 6 Troubleshooting

If the UPS system is not operating correctly, check the operating status on the LCD display. Table 12 below provides the problem, possible cause, and possible solution for several warning

and fault codes. Use the table below for troubleshooting purposes before contacting the After-Sales Service Department.

Table 12: Warning and fault codes

Warning & Fault Code	Problem	Possible cause	Solution
/	No indication, no warning tone even though system is connected to mains power supply	<ul style="list-style-type: none"> <li>No input voltage</li> <li>Breaker open</li> </ul>	<ul style="list-style-type: none"> <li>Check building wiring socket outlet and input cable.</li> <li>Check the Breaker.</li> </ul>
/	No Communication data	<ul style="list-style-type: none"> <li>RS232 wire is not matched</li> <li>USB wire is not matched</li> </ul>	<ul style="list-style-type: none"> <li>Check or change the RS232 wire.</li> <li>Check or change the USB wire.</li> </ul>
/	Emergency supply period shorter than nominal value	<ul style="list-style-type: none"> <li>Batteries not fully charged</li> <li>Batteries defective</li> </ul>	<ul style="list-style-type: none"> <li>Charge the batteries until fully charged.</li> <li>Change the batteries or consult your dealer.</li> </ul>
<b>FANF</b>	Fan failure	Fan abnormal	Check the fan status; if the fan is not running properly, report this to your local dealer / sales office.
<b>HIGH</b>	Battery over voltage	Battery is over charged	Switch to battery mode. Once the battery voltage is normal and the mains is normal, the UPS will switch to line mode automatically again.
<b>bLOW</b>	Battery low	Battery voltage is low	<ul style="list-style-type: none"> <li>Charge the batteries until fully charged.</li> <li>Change the batteries or consult your dealer.</li> </ul>
<b>bOPN</b>	Battery open	Battery pack is not connected correctly	<ul style="list-style-type: none"> <li>Conduct battery test to confirm.</li> <li>Check the battery bank is connected to the UPS.</li> <li>Check the battery breaker is turn on.</li> </ul>
<b>CHGF</b>	Charge fail	The charge is broken	Notify dealer.
<b>dCHF</b>	Digital bigger charger fails	The charge is broken	Notify dealer.
<b>bUSH</b>	Bus high	UPS internal fault	Notify dealer.
<b>bUSL</b>	Bus low	UPS internal fault	Notify dealer.
<b>bsFT</b>	Bus soft start fail	UPS internal fault	Notify dealer.
<b>bUSS</b>	Bus short	UPS internal fault	Notify dealer.
<b>TEPH</b>	Inverter temperature high	Inside temperature of the UPS is too high	<ul style="list-style-type: none"> <li>Check the ventilation of the UPS.</li> <li>Check the ambient temperature.</li> </ul>
<b>ITPH</b>	Inner Ambient temperature high	The ambient temperature is too high	Check the environment ventilation.
<b>INVH</b>	Inverter high	UPS internal fault	Notify dealer.
<b>INVL</b>	Inverter low	UPS internal fault	Notify dealer.
<b>ISFT</b>	Inverter soft start fail	UPS internal fault	Notify dealer.
<b>NTCO</b>	Inverter NTC open	UPS internal fault	Notify dealer.
<b>SHOR</b>	Inverter short	Output short circuit	<ol style="list-style-type: none"> <li>Remove all the loads.</li> <li>Turn off the UPS.</li> <li>Check whether the output of the UPS and loads are short circuited.</li> <li>Make sure the short circuit is removed, and the UPS has no internal faults before turning on again.</li> </ol>
<b>OVTP</b>	Over temperature fault	Over temperature	<ul style="list-style-type: none"> <li>Check the ventilation of the UPS.</li> <li>Check the ambient temperature and ventilation.</li> </ul>
<b>OVLD</b>	Overload	Overload	<ul style="list-style-type: none"> <li>Check the loads and remove some non-critical loads.</li> <li>Check whether some loads are failed.</li> </ul>
<b>SITE</b>	Site fail	Phase and neutral conductor at input of the UPS system are reversed	Rotate mains power socket by 180° or connect UPS system.
<b>EPO</b>	EPO active	EPO function is enabled	Plug into the EPO switch.

If you are unable to troubleshoot the problem or find a solution, have the following information on hand before calling the After-Sales Service Department:

- Model number and serial number
- Date on which the problem occurred
- LCD display status and audible alarm status

- Mains power condition, load type and capacity, environment temperature, ventilation condition
- Information (battery capacity, quantity) about the external battery pack
- Additional information for a complete description of the problem

---

# 7 Maintenance and storage

---

## 7.1 Operation

The UPS system contains no user-serviceable parts. The PowerValue 11 T G2 1-3 kVA UPS requires only minimal maintenance.

Charge the UPS regularly to maximize the expected life of the battery. When connected to mains power, the UPS charges the batteries and prevents them from overcharging and over-discharging.

- Replace the batteries when the battery service life has been exceeded (around three to five years at 25°C ambient temperature). Contact your local ABB or an agent authorized by ABB for information about the replacement.
- Charge the UPS once every four to six months if it is not used regularly.
- In high-temperature regions, charge and discharge the battery every two months. The standard charging time should be at least 12 hours.
- Replace the battery when the discharge time is less than 50 percent of specified after fully charging. Check the battery connection or contact your local dealer to order a new battery.

---

## 7.2 Storage

If the batteries are stored in temperate climates, it is recommended to recharge those batteries every 3 months for 1-2 hours.

It is highly recommended to shorten the recharging intervals to every 2 months at locations subject to high temperatures.

# 8 Communication ports

## 8.1 USB and WinPower communication ports

### 8.1.1 USB and RS-232 communication ports

To establish communication between the UPS and a computer, use an appropriate communication cable. USB communication is higher priority than RS-232, that means when USB and RS-232 are connected at the same time, only the USB communication is working.

### 8.1.2 USB for HID power device

The USB interface offers a “smart battery” feature which supports Human Interface Device (HID) Power Device Class and does not require additional software to be installed.

The computer’s Operating System (OS), such as Windows/Linux/Mac OS, comes with an embedded power management and monitoring function. When the computer connects to the UPS via USB cable, the UPS is automatically recognized by the OS as an “HID UPS Battery”, and you can configure the alarm action in the event of low battery, such as shutting down the computer automatically. This feature on the UPS is also ideal as a back-up power for the Network-Attached Storage (NAS).

### 8.1.3 Mini AS400 interface (optional)

The UPS is equipped with isolated dry contact relay outputs to indicate its status.

These relay outputs indicate Mains/Utility failure, Battery low, UPS alarm/OK, Bypass, etc.

To see more detail about the interface definitions, check the Mini AS400 user manual.

### 8.1.4 Mini WinPower ModBus card (optional)

The Mini WinPower ModBus card provides connection to Modbus protocols with a standard RS485 signal.

To see more detail, check the Mini WinPower ModBus card user manual.

### 8.1.5 Mini WinPower SNMP card (optional)

The Mini WinPower SNMP card allows the UPS to communicate in a variety of networking environments and with different device types. The Mini WinPower SNMP card achieves remote management for the UPS through internet/intranet.

Contact your local dealer for further information, or check the Mini WinPower SNMP card user manual.

# 9 Software

## 9.1 WinPower

### 9.1.1 Free software download—WinPower

WinPower is a brand-new UPS monitoring software which provides a user-friendly interface to monitor and control your UPS. This unique software provides safe auto-shutdown for multi-computer systems during power failure. With this software, users can monitor and control any UPS on the same LAN regardless how far from the UPSs.

### 9.1.2 Installation

1. Go to the website:  
<http://www.ups-software-download.com/winpower.htm>
2. Choose the operating system (OS) you need and follow the instructions on the website to download the software.
3. When downloading all required files from the internet, enter the serial No: 511C1-01220-0100-478DF2A to install the software.
4. When your computer restarts, the WinPower software will appear as a green plug icon located in the system tray, near the time.

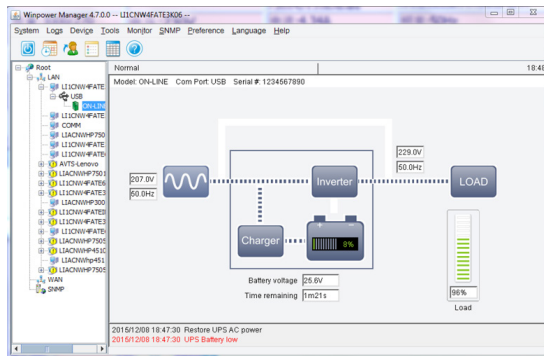

# 10 Rear panel view (IEC)

—  
 14 PowerValue 11T G2  
 1kVA B and PowerValue  
 11T G2 1kVA S  
 —  
 15 PowerValue 11T G2  
 2kVA B and PowerValue  
 11T G2 2kVA S

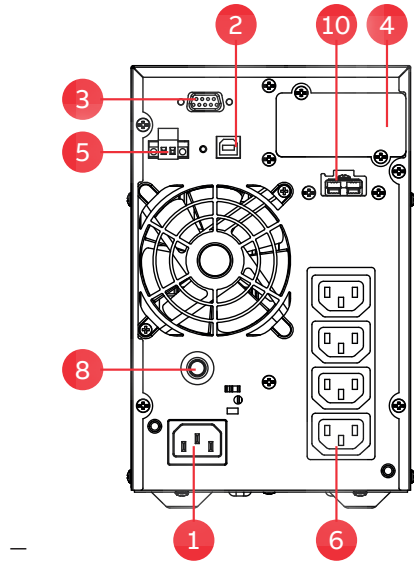

—  
 14

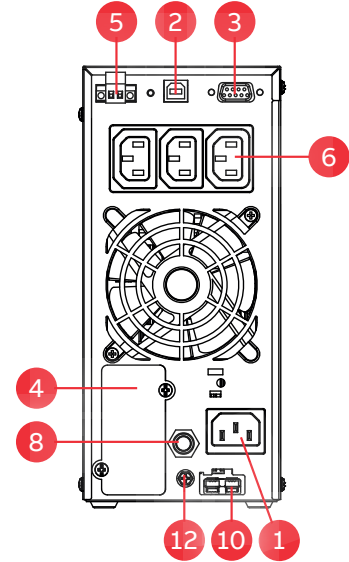

1. AC input 10 A	4. Mini SNMP/ Mini ModBus / Mini AS400	7. AC input 16 A	10. EBM connector
2. USB port	5. EPO / dry input	8. Output breaker	11. AC input 20 A
3. RS-232	6. AC output 10 A	9. AC output 16 A	12. GND contact

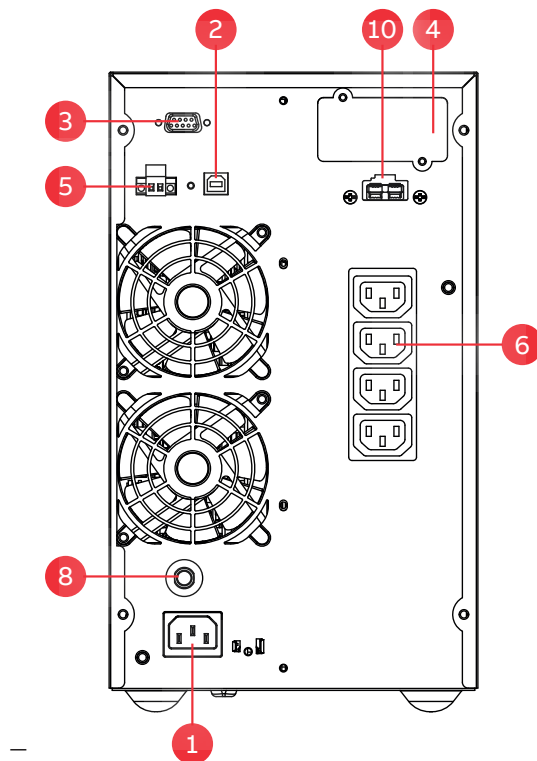

—  
 15

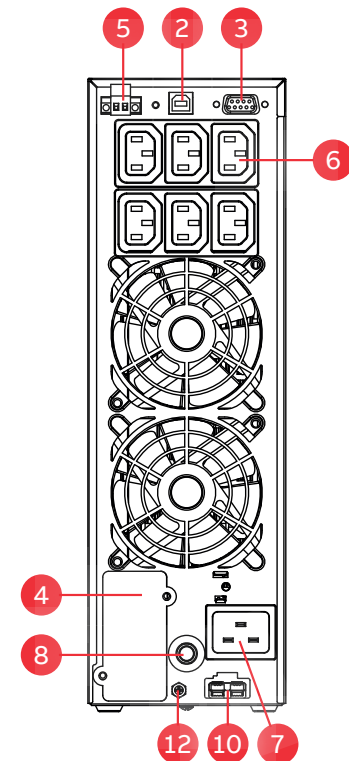

—  
16 PowerValue 11T G2  
3kVA B and PowerValue  
11T G2 3kVA S

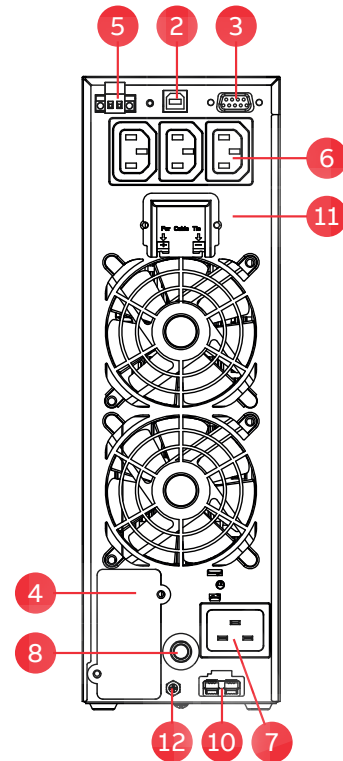
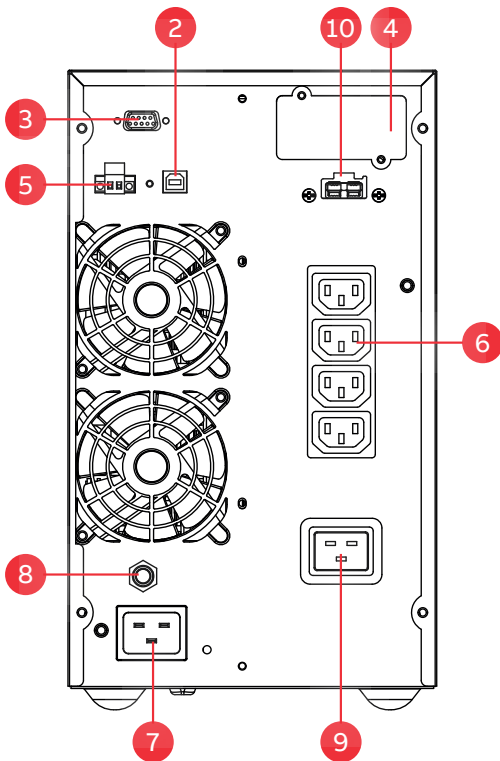

—  
16

1. AC input 10 A	4. Mini SNMP/ Mini ModBus / Mini AS400	7. AC input 16 A	10. EBM connector
2. USB port	5. EPO / dry input	8. Output breaker	11. AC output 20 A
3. RS-232	6. AC output 10 A	9. AC output 16 A	12. GND contact



# 11 Technical specifications

## 11.1 Technical Data Sheet

GENERAL DATA	G2 1kVA B/ S	G2 2kVA B/ S	G2 3kVA B/ S
Output rated power	900 W	1'800W	2'700W
Output power factor	0.9	0.9	0.9
Topology	Online double conversion		
Parallel configuration	No	No	No
Inbuilt batteries	Yes/No	Yes/No	Yes/No
<b>INPUT</b>			
Nominal input voltage	220/230/240 VAC		
Input voltage tolerance	100-300 VAC (load dependent)		
Input current THDi	5% with full resistive load		
Frequency range	45-55 Hz / 54-66 Hz		
Power factor	≥0.99		
<b>OUTPUT</b>			
Rated output voltage	220/230/240 VAC		
Voltage tolerance	±1% (referred to 230V)		
Voltage distortion	<2% linear load, <6% non linear load		
Overload capacity (linear load) on inverter	60s: 106-130% load 10s: 131-150% load 300ms: ≥ 150% load		
Nominal frequency	50 or 60 Hz		
Crest factor	3:1 (load supported)		
<b>EFFICIENCY</b>			
Overall system efficiency	Up to 89%	Up to 91%	Up to 91%
In eco-mode	Up to 97.5%	Up to 98%	Up to 98%
<b>ENVIRONMENT</b>			
Protection rating	IP20		
Storage temperature	UPS: -25°C to 60°C; Batteries: 0°C to 35°C		
Operating temperature	0°C to 40°C		
Relative humidity	0% to 95%		
Altitude (above sea level)	1000m without derating		
<b>BATTERIES</b>			
Type	VRLA (valve regulated lead-acid)		
Inbuilt batteries	2x9.4 Ah (B)	4x9.4Ah(B)	6x9.4Ah(B)
Charging current	1.5A/3-6A adjustable	1.5A/1.5-6A adjustable	1.5A/1.5-6A adjustable
Recharge time (inbuilt batteries)	4h to 90%		
<b>COMMUNICATIONS</b>			
User interface	LCD display		
Optional communication cards	SNMP;ModBus;AS400;Environmental monitoring sensor probe		
<b>STANDARDS</b>			
Safety	IEC/EN 62040-1		
EMC	IEC/EN 62040-2		
Performance	IEC/EN 62040-3		
Manufacturing	ISO 9001:2015, ISO 14001:2015, OHSAS 18001		
<b>WEIGHT, DIMENSIONS</b>			
Weight	9.2/3.9 Kg	17.4/6.4 Kg	22.7/6.4 Kg
Dimensions w x h x d	144x228x356 mm 102x228x346mm	190x327x399 mm 102x327x390 mm	190x327x399 mm 102x327x390 mm

## 11.2 Battery runtime

Table 13: Battery runtime values

	UPS	UPS+1EBM	UPS+2EBM	UPS+3EBM	UPS+4EBM
PowerValue 11T G2 1 kVA B	5/8.5/13.5/27	23/35/65/135	52/80/130/275	85/120/200/425	120/170/275/580
PowerValue 11T G2 1 kVA S	-	17/27/48/95	48/68/100/190	70/100/155/285	100/140/1995/380
PowerValue 11T G2 2 kVA B	5.5/9/14/28	25/38/68/145	55/85/135/280	90/130/210/425	125/180/290/600
PowerValue 11T G2 2 kVA S	-	18/28/48/105	50/70/110/210	80/110/165/315	110/150/210/410
PowerValue 11T G2 3 kVA B	5.5/9/14/29.5	16.5/25/45/105	35/53/90/195	55/85/135/295	80/115/185/405
PowerValue 11T G2 3 kVA S	-	10.5/16/28/65	28/45/70/130	50/72/110/190	70/100/140/250

The table above shows battery autonomy in minutes at 100 / 75 / 50 / 25% load at nominal power factor.

The given runtimes are an estimate at 20°C; the actual runtime of the system will depend on the age of batteries, environmental conditions, etc.



—  
[www.abb.com/ups](http://www.abb.com/ups)  
[ups.sales@ch.abb.com](mailto:ups.sales@ch.abb.com)

